



**THE DATASHEET OF
SMM-105-01-S-S**



REVISION BJ

DO NOT SCALE FROM THIS PRINT

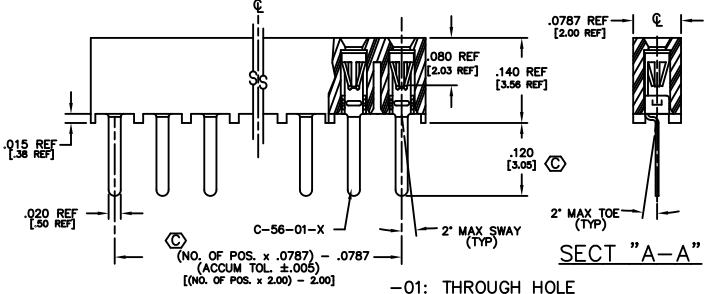
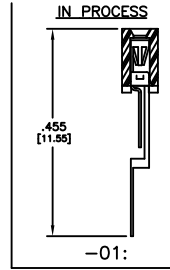
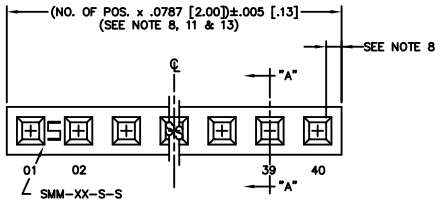

* PINS INTERLEAVED AND ORIENTED SAME DIRECTION FOR -01 ONLY

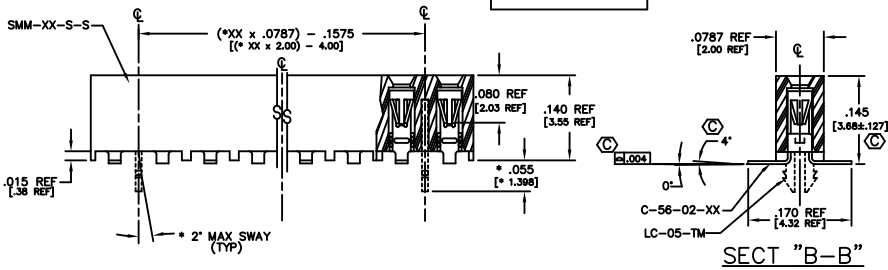
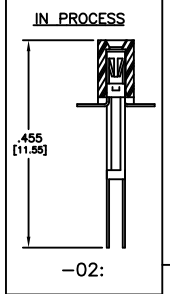
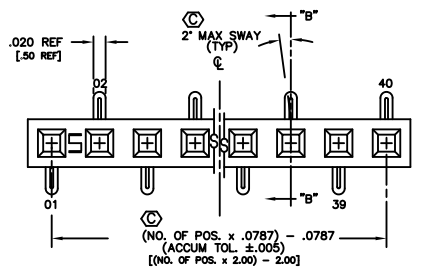

-02: SURFACE MOUNT

- NOTES:
- RETENTION FORCE IN BODY TO BE: 1 lbs. MIN
 - INSERTION FORCE TO BE: 3.0 oz. MAX.
 - WITHDRAWAL FORCE TO BE: 0.4 oz. MIN.
 - ⊙ REPRESENTS CRITICAL DIMS. FOR STATISTICAL PROCESS CONTROL.
 - [] DIMS ARE IN METRIC AND ARE NOT CONTROLLING DIMS.
 - SMM-105-01-X THRU SMM-140-01-X MUST USE PT-1-24-01-12.
 - LC OPTION FOR A 02 POSITION WILL HAVE ONLY ONE LOCKING CLIP (LC-05-T).
 - "END WALLS" AFTER CUTTING SHOULD BE .025±.005.
 - ALL OPTIONS: PACKAGE POSITIONS -04 THRU -40 IN TUBES.
 - LAYER PACKAGE POSITIONS -02 & -03 WITH NO OPTIONS.
 - 02 THRU -05 POSITION WITH -K OR -P TO BE PACKAGED IN -TR ONLY. -06 THRU -40 POSITION AVAILABLE IN TUBE OR -TR PACKAGING.
 - MAX CUT FLASH: .010 [25]
 - DUE TO THE HIGH AMOUNT OF INSERTION FORCE NEEDED, THE -LC OPTION IS NOT COMPATIBLE WITH AUTO PLACEMENT. SAMTEC RECOMMENDS MANUAL PLACEMENT FOR ALL ASSEMBLIES WITH THE -LC OPTION.
 - FOR -02 LEAD STYLE: EVEN CUTS: LOSE 2 POSITIONS PER CUT; ODD CUTS: LOSE 1 POSITION PER CUT.
 - INSULATOR MATERIAL: BLACK, LCP, UL 94 VO
 - MAXIMUM PIN HEIGHT VARIATION: .003 [08] FROM ROW TO ROW AND PIN TO PIN, MUST BE MEASURED BETWEEN ADJACENT PINS.

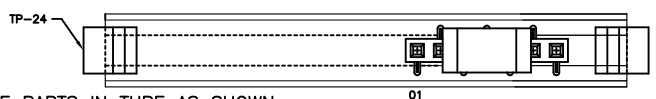
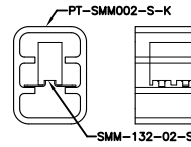

PACKAGE PARTS IN TUBE AS SHOWN (POSITION PARTS WITH POS. -01 TOWARD ARROW AS SHOWN)

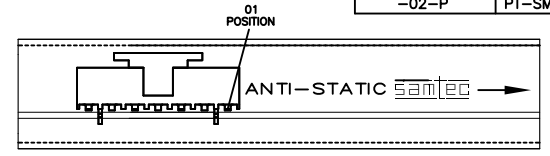
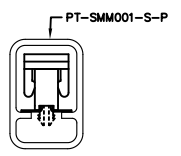
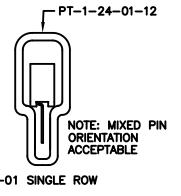

DIMENSIONS ARE IN INCHES UNLESS OTHERWISE NOTED TOLERANCES ARE ANGLES ± 1°

ONE PLACE DECIMALS: ± .1
TWO PLACE DECIMALS: ± .01
THREE PLACE DECIMALS: ± .005
FOUR PLACE DECIMALS: ± .0020

TITLE: 2 mm SOCKET STRIP (SINGLE ROW)
DWG NO.: SMM-1XX-XX-XX-S-XX-X-XX-XX
SHEET 1 OF 1

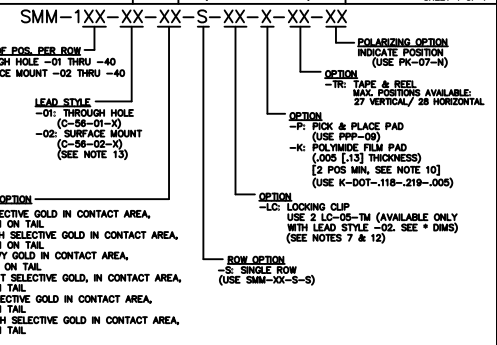

TUBE PACKAGING TABLE

LEAD STYLE	TUBE	PLUG
-01	PT-1-24-01-12	TP-12
-01-P	PT-1-24-02-29	TP-24
-02		
-02-K, -02-LC, -02-LC-K	PT-SMM002-S-K	TP-24-02
-02-P	PT-SMM001-S-P	TP-24

PROPRIETARY NOTE

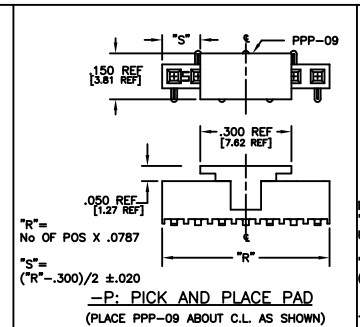

-P: PICK AND PLACE PAD (PLACE PPP-09 ABOUT C.L. AS SHOWN)

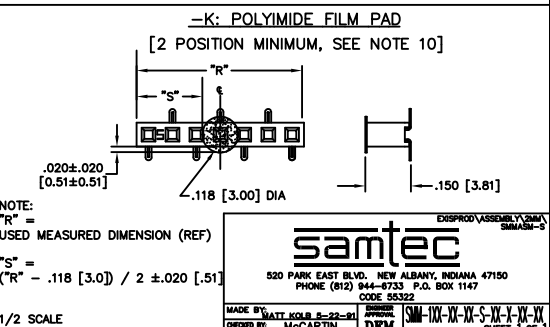

NOTE:
"R" = USED MEASURED DIMENSION (REF)
"S" = ("R" - .300) / 2 ± 0.20
1/2 SCALE

ANTI-STATIC samtec

520 PARK EAST BLVD. NEW ALBANY, INDIANA 47150
PHONE (812) 944-6733 P.O. BOX 1147
CODE 55322

MADE BY: WATT KOLB B-22-81
DESIGNED BY: MCCARTIN

ENDPROD VASSER/ST/25/11/03/03
SHEET 1 OF 1

Looking for pricing, stock, or lifecycle information?

Click below to explore more details on WIN SOURCE:

 [View SMM-105-01-S-S on WIN SOURCE](#)

 [Samtec Inc. Information](#)

Optimize Your Supply Chain with WIN SOURCE Solutions

-  Global Sourcing Solution
-  Obsolete Management
-  Cost Control Management
-  Shortage Management
-  Alternative Solution
-  Excess Inventory Management