



THE DATASHEET OF SGL5N150UFTU



SGL5N150UF

General Description

Fairchild's Insulated Gate Bipolar Transistor (IGBT) provides low conduction and switching losses. SGL5N150UF is designed for the Switching Power Supply applications.

Features

- High Speed Switching
- Low Saturation Voltage : $V_{CE(sat)} = 4.7\text{ V @ } I_C = 5\text{ A}$
- High Input Impedance

Application

Switching Power Supply - High Input Voltage Off-line Converter

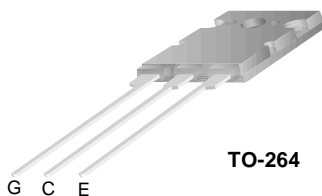

TO-264

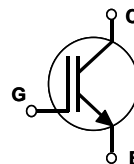

Absolute Maximum Ratings $T_C = 25^\circ\text{C}$ unless otherwise noted

Symbol	Description	SGL5N150UF	Units
V_{CES}	Collector-Emitter Voltage	1500	V
V_{GES}	Gate-Emitter Voltage	± 20	V
I_C	Collector Current @ $T_C = 25^\circ\text{C}$	10	A
	Collector Current @ $T_C = 100^\circ\text{C}$	5	A
$I_{CM(1)}$	Pulsed Collector Current	20	A
P_D	Maximum Power Dissipation @ $T_C = 25^\circ\text{C}$	125	W
	Maximum Power Dissipation @ $T_C = 100^\circ\text{C}$	50	W
T_J	Operating Junction Temperature	-55 to +150	$^\circ\text{C}$
T_{stg}	Storage Temperature Range	-55 to +150	$^\circ\text{C}$
T_L	Maximum Lead Temp. for Soldering Purposes, 1/8" from Case for 5 Seconds	300	$^\circ\text{C}$

Notes :

(1) Repetitive rating : Pulse width limited by max. junction temperature

Thermal Characteristics

Symbol	Parameter	Typ.	Max.	Units
$R_{\theta JC}$	Thermal Resistance, Junction-to-Case	--	1	$^\circ\text{C}/\text{W}$
$R_{\theta JA}$	Thermal Resistance, Junction-to-Ambient	--	25	$^\circ\text{C}/\text{W}$

Electrical Characteristics of IGBT $T_C = 25^\circ\text{C}$ unless otherwise noted

Symbol	Parameter	Test Conditions	Min.	Typ.	Max.	Units
Off Characteristics						
BV_{CES}	Collector-Emitter Breakdown Voltage	$V_{GE} = 0V, I_C = 1mA$	1500	--	--	V
I_{CES}	Collector Cut-Off Current	$V_{CE} = V_{CES}, V_{GE} = 0V$	--	--	1.0	mA
I_{GES}	G-E Leakage Current	$V_{GE} = V_{GES}, V_{CE} = 0V$	--	--	± 100	nA
On Characteristics						
$V_{GE(th)}$	G-E Threshold Voltage	$I_C = 5mA, V_{CE} = V_{GE}$	2.0	3.0	4.0	V
$V_{CE(sat)}$	Collector to Emitter Saturation Voltage	$I_C = 5A, V_{GE} = 10V$	--	4.7	5.5	V
Dynamic Characteristics						
C_{ies}	Input Capacitance	$V_{CE} = 10V, V_{GE} = 0V,$ $f = 1MHz$	--	780	--	pF
C_{oes}	Output Capacitance		--	130	--	pF
C_{res}	Reverse Transfer Capacitance		--	70	--	pF
Switching Characteristics						
$t_{d(on)}$	Turn-On Delay Time	$V_{CC} = 600V$ $I_C = 5A$ $R_G = 10\Omega$ $V_{GE} = 10V$ Inductive Load $T_C = 25^\circ\text{C}$	--	10	--	ns
t_r	Rise Time		--	15	--	ns
$t_{d(off)}$	Turn-Off Delay Time		--	30	50	ns
t_f	Fall Time		--	70	120	ns
E_{on}	Turn-On Switching Loss		--	190	--	μJ
E_{off}	Turn-Off Switching Loss		--	100	--	μJ
E_{ts}	Total Switching Loss		--	290	580	μJ
Q_g	Total Gate Charge		--	30	45	nC
Q_{ge}	Gate-Emitter Charge		$V_{CE} = 600V, I_C = 5A$	--	3	5
Q_{gc}	Gate-Collector Charge	$V_{GE} = 10V$	--	15	25	nC

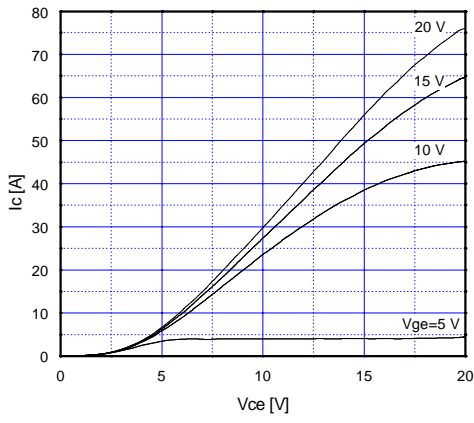

Fig 1. Typical Output Characteristics

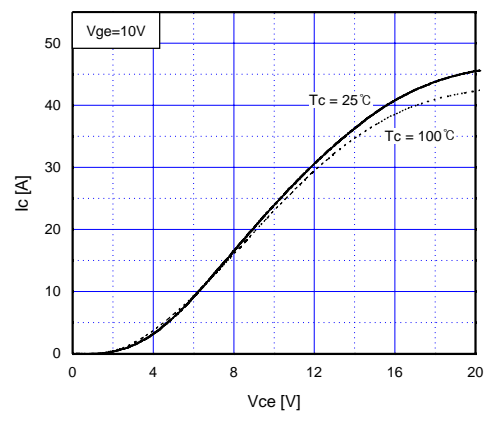

Fig 2. Typical Output Characteristics

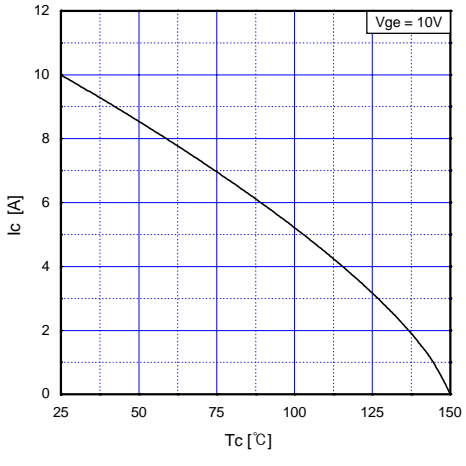

Fig 3. Maximum Collector Current vs. Case Temperature

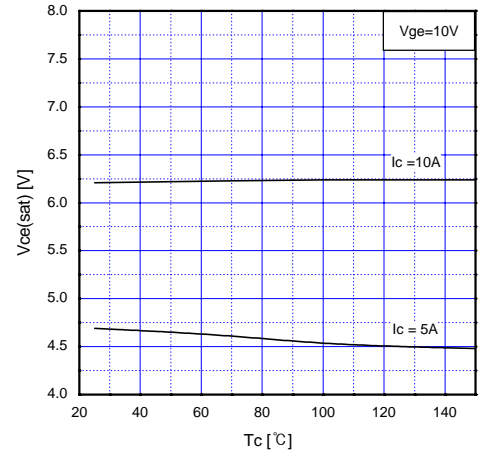

Fig 4. Saturation Voltage vs. Case Temperature

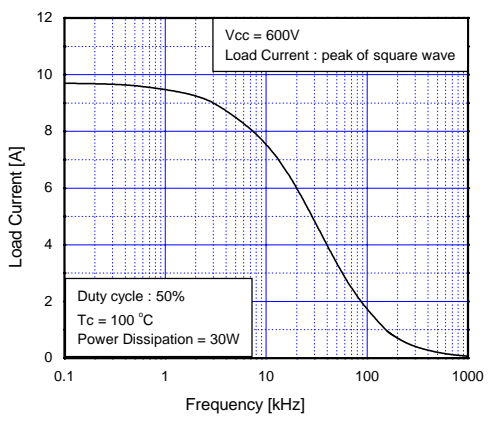

Fig 5. Load Current vs. Frequency

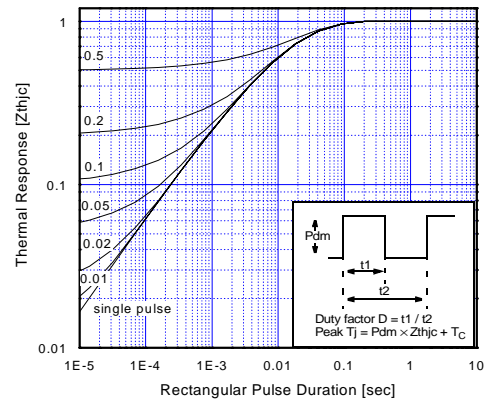

Fig 6. Transient Thermal Impedance of IGBT Junction to Case

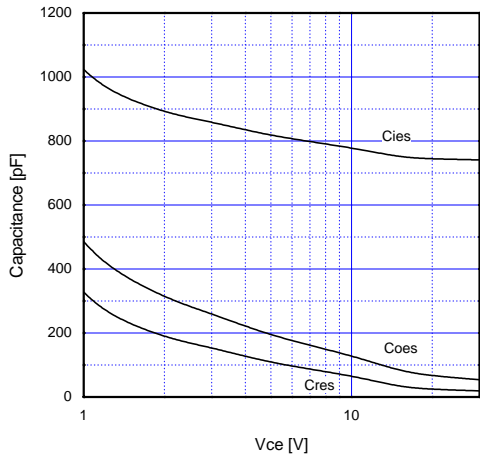

Fig 7. Typical Capacitance vs. Collector to Emitter Voltage

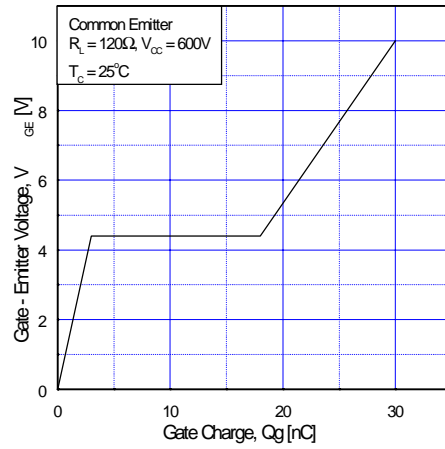

Fig 8. Typical Gate Charge Characteristic

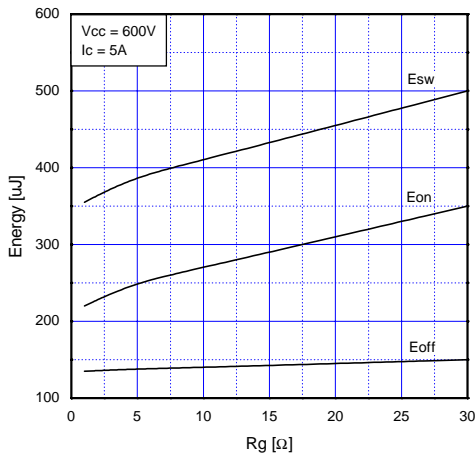

Fig 9. Typical Switching Loss vs. Gate Resistance

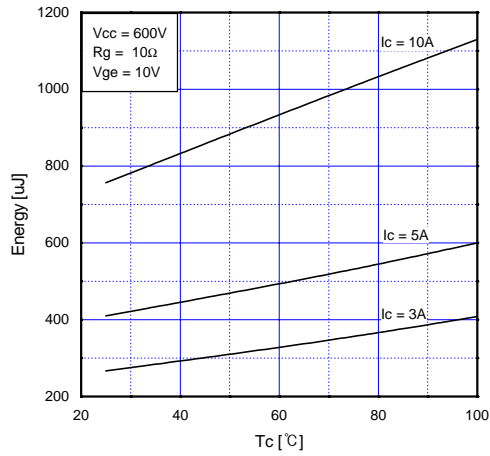

Fig 10. Typical Switching Loss vs. Case Temperature

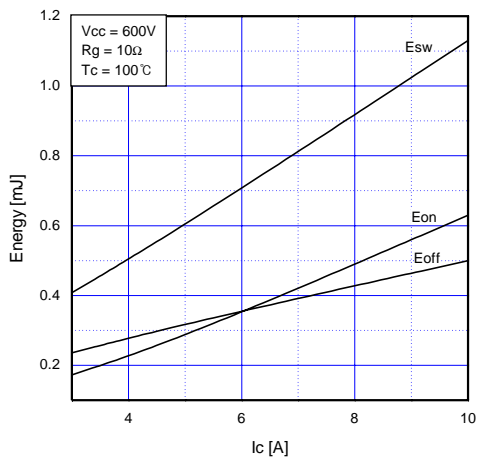

Fig 11. Typical Switching Loss vs. Collector Current

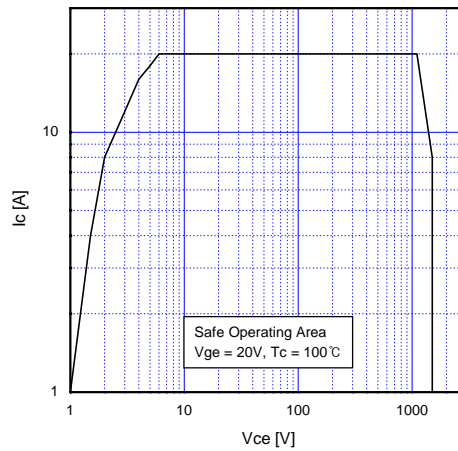
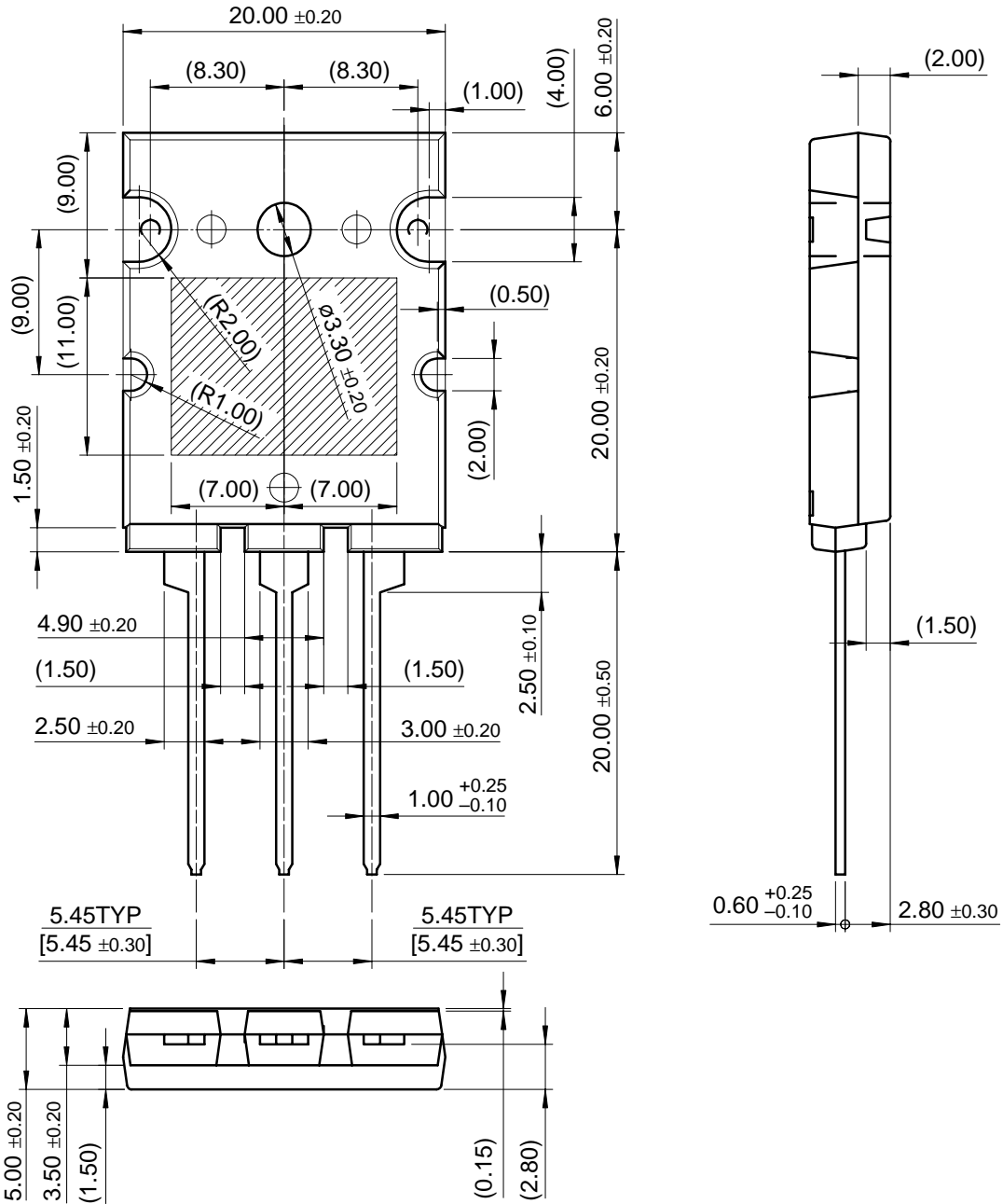

Fig 12. Turn-Off SOA

Package Dimension

TO-264 (FS PKG CODE AR)



Dimensions in Millimeters

TRADEMARKS

The following are registered and unregistered trademarks Fairchild Semiconductor owns or is authorized to use and is not intended to be an exhaustive list of all such trademarks.

ACEx™	FACT™	ImpliedDisconnect™	PACMAN™	SPM™
ActiveArray™	FACT Quiet series™	ISOPLANAR™	POP™	Stealth™
Bottomless™	FAST®	LittleFET™	Power247™	SuperSOT™-3
CoolFET™	FASTR™	MicroFET™	PowerTrench®	SuperSOT™-6
CROSSVOLT™	FRFET™	MicroPak™	QFET™	SuperSOT™-8
DOME™	GlobalOptoisolator™	MICROWIRE™	QS™	SyncFET™
EcoSPARK™	GTO™	MSX™	QT Optoelectronics™	TinyLogic®
E ² CMOS™	HiSeC™	MSXPro™	Quiet Series™	TruTranslation™
EnSigna™	I ² C™	OCX™	RapidConfigure™	UHC™
Across the board. Around the world.™		OCXPro™	RapidConnect™	UltraFET®
Across the board. Around the world™		OPTOLOGIC®	SILENT SWITCHER®	VCX™
The Power Franchise™		OPTOPLANAR™	SMART START™	

DISCLAIMER

FAIRCHILD SEMICONDUCTOR RESERVES THE RIGHT TO MAKE CHANGES WITHOUT FURTHER NOTICE TO ANY PRODUCTS HEREIN TO IMPROVE RELIABILITY, FUNCTION OR DESIGN. FAIRCHILD DOES NOT ASSUME ANY LIABILITY ARISING OUT OF THE APPLICATION OR USE OF ANY PRODUCT OR CIRCUIT DESCRIBED HEREIN; NEITHER DOES IT CONVEY ANY LICENSE UNDER ITS PATENT RIGHTS, NOR THE RIGHTS OF OTHERS.

LIFE SUPPORT POLICY

FAIRCHILD'S PRODUCTS ARE NOT AUTHORIZED FOR USE AS CRITICAL COMPONENTS IN LIFE SUPPORT DEVICES OR SYSTEMS WITHOUT THE EXPRESS WRITTEN APPROVAL OF FAIRCHILD SEMICONDUCTOR CORPORATION.

As used herein:

1. Life support devices or systems are devices or systems which, (a) are intended for surgical implant into the body, or (b) support or sustain life, or (c) whose failure to perform when properly used in accordance with instructions for use provided in the labeling, can be reasonably expected to result in significant injury to the user.
2. A critical component is any component of a life support device or system whose failure to perform can be reasonably expected to cause the failure of the life support device or system, or to affect its safety or effectiveness.

PRODUCT STATUS DEFINITIONS

Definition of Terms

Datasheet Identification	Product Status	Definition
Advance Information	Formative or In Design	This datasheet contains the design specifications for product development. Specifications may change in any manner without notice.
Preliminary	First Production	This datasheet contains preliminary data, and supplementary data will be published at a later date. Fairchild Semiconductor reserves the right to make changes at any time without notice in order to improve design.
No Identification Needed	Full Production	This datasheet contains final specifications. Fairchild Semiconductor reserves the right to make changes at any time without notice in order to improve design.
Obsolete	Not In Production	This datasheet contains specifications on a product that has been discontinued by Fairchild semiconductor. The datasheet is printed for reference information only.

Looking for pricing, stock, or lifecycle information?

Click below to explore more details on WIN SOURCE:

-  [View SGL5N150UFTU on WIN SOURCE](#)
-  [Fairchild/ON Semiconductor Information](#)

Optimize Your Supply Chain with WIN SOURCE Solutions

-  Global Sourcing Solution
-  Obsolete Management
-  Cost Control Management
-  Shortage Management
-  Alternative Solution
-  Excess Inventory Management