



**THE DATASHEET OF
SBT-90-W65S-F71-NA100**



SBT-90 LEDs

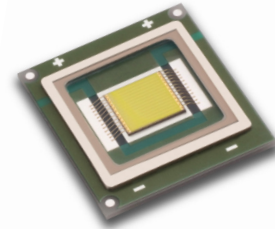
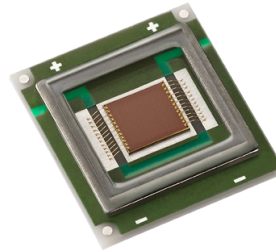



Table of Contents

Technology Overview2

Binning Structure3

Chromaticity Bins4

Product Shipping & Labeling Information.....5

Ordering Information6

Electrical Characteristics ...7

Optical Characteristics8

White Characteristics.....9

Radiation Patterns 10

Output vs Temp ,Lifetime and Spectrum..... 11

Mechanical Dimensions .. 12

Solder Profile 14

History of Changes 15

Features:

- Extremely high optical output from a 9 mm² square emitter:
 - Up to 2300 lumens at 13.5A from a single chip (White)
 - Over 1,600 lumens at 13.5A (Red)
 - Choice of 5700K or 6500K color point
- High thermal conductivity package - junction to case thermal resistance of only 0.5 °C/W
- Large, monolithic chip with uniform emitting area of 9 mm²
- Unencapsulated die with low profile protective window optimizes optical coupling in etendue-limited applications
- Electrically isolated thermal path
- Environmentally friendly: RoHS compliant

Applications

- Fiber-coupled illumination
- Architectural and Entertainment lighting
- Projection and micro-display based applications
- High-Brightness and large format LCD back-light units
- Edge-illuminated lighting guides
- High output, Etendue-limited lighting applications

Technology Overview

Luminus LED benefit from a suite of innovations in the fields of chip technology, packaging and thermal management. These breakthroughs allow illumination engineers and designers to achieve solutions that are high brightness and high efficiency.

Luminus Technology

Luminus' technology enables large area LED chips with uniform brightness over the entire LED chip surface. The optical power and brightness produced by these large monolithic chips enable solutions which replace arc and halogen lamps where arrays of traditional high power LEDs cannot.

Packaging Technology

Thermal management is critical in high power LED applications. With a thermal resistance from junction to heat sink of 0.5°C/W , Luminus SBT-90 LEDs have the lowest thermal resistance of any LED on the market. This allows the LED to be driven at higher current densities while maintaining a low junction temperature, thereby resulting in brighter solutions and longer lifetimes.

Reliability

Designed from the ground up, Luminus LEDs are one of the most reliable light sources in the world today. They have passed a rigorous suite of environmental and mechanical stress tests, including mechanical shock, vibration, temperature cycling and humidity, and have been fully qualified for use in extreme high power and high current applications. With very low failure rates and median lifetimes that typically exceed 60,000 hours, Luminus LEDs are ready for even the most demanding applications.

Environmental Benefits

Luminus LEDs Whitehelp reduce power consumption and the amount of hazardous waste entering the environment. All Luminus LED products manufactured by Luminus are RoHS compliant and free of hazardous materials, including lead and mercury.

Understanding Luminus LED Test Specifications

Every Luminus LED is fully tested to ensure that it meets the high quality standards expected from Luminus' products.

Testing Temperature

Luminus surface mount LEDs are typically tested with a 20 msec input pulse and a junction temperature of 25°C . Expected flux values in real world operation can be extrapolated based on the information contained within this product data sheet.

Multiple Operating Points

The tables on the following pages provide typical optical and electrical characteristics. Since the LEDs can be operated over a wide range of drive conditions (currents from less than 1A to 13.5A, and duty cycle from <1% to 100%), multiple drive conditions are listed.

SBT-90 White LEDs are production tested at 9.0 A. The values shown at other current conditions are for additional reference at other possible drive conditions.

SBT-90 Red LEDs are productions tested of 13.5A

SBT-90 Binning Structure

SBT-90 LEDs are tested for luminous flux and chromaticity of the drive current specified below and placed into one of the following luminous flux (FF) and chromaticity (WW) bins:

Flux Bins

Color	Flux Bin (FF)	Minimum Flux (lm) @ 9.0A	Maximum Flux (lm) @ 9.0A
W57S/ W65S 5700K / 6500K, Standard CRI (typ. 70)	NA	1,590	1,710
	NB	1,710	1,830
	PA	1830	1966
	PB	1966	2100
	QA	2100	2260
	QB	2260	2420
Red	Flux Bin (FF)	Minimum Flux (lm) @ 13.5A	Minimum Flux (lm) @ 13.5A
	BM	770	970
	BN	970	1150
	BP	1150	1350
	BQ	1350	1570
	BR	1570	1850

Wavelength Bins

Color	Wavelength Bin (WW)	Minimum Wavelength @ 13.5A	Maximum Wavelength @ 13.5A
Red	R3	615	619
	R4	619	623
	R5	623	627

*Note: Luminus maintains a +/- 6% tolerance on flux measurements. Luminus maintains a +/- 2% tolerance on CRI measurements.

Chromaticity Bins

Luminus' Standard Chromaticity Bins: 1931 CIE Curve

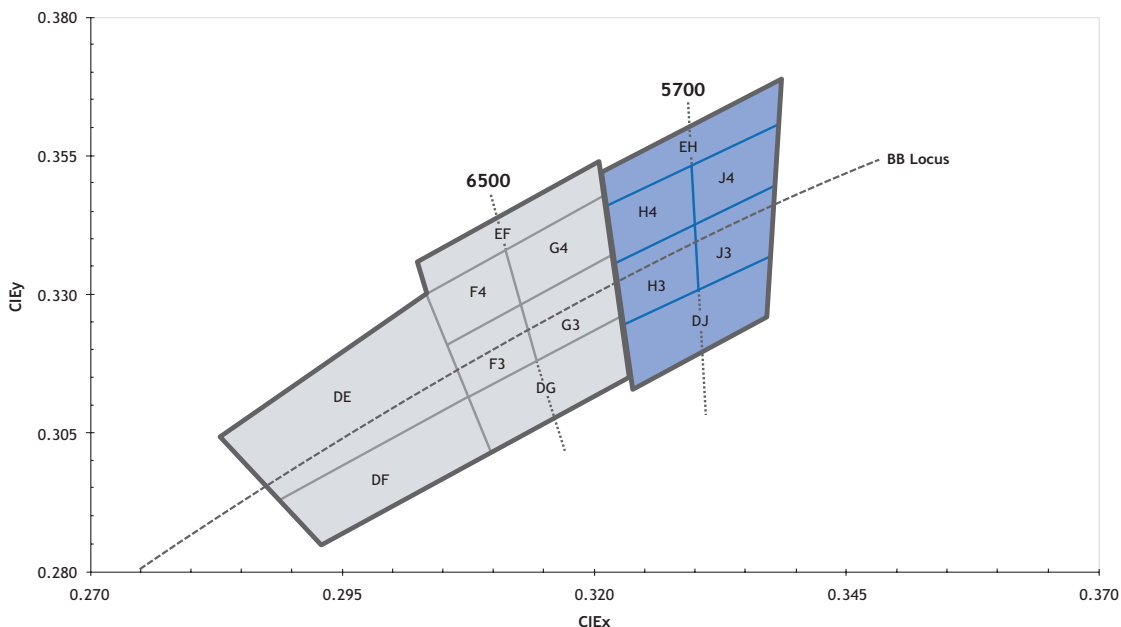

The following tables describe the four chromaticity points that bound each chromaticity bin. Chromaticity bins are grouped together based on the color temperature.

6500K Chromaticity Bins		
Bin Code (WW)	CIE _x	CIE _y
DG	0.307	0.311
	0.322	0.326
	0.323	0.316
	0.309	0.302
F3*	0.305	0.321
	0.313	0.329
	0.315	0.319
	0.307	0.311
F4*	0.303	0.330
	0.312	0.339
	0.313	0.329
	0.305	0.321
G3*	0.313	0.329
	0.321	0.337
	0.322	0.326
	0.315	0.319
G4*	0.312	0.339
	0.321	0.348
	0.321	0.337
	0.313	0.329
EF	0.302	0.335
	0.320	0.354
	0.321	0.348
	0.303	0.330
DE	0.283	0.304
	0.303	0.330
	0.307	0.311
	0.289	0.293
DF	0.289	0.293
	0.307	0.311
	0.309	0.302
	0.293	0.285

5700K Chromaticity Bins		
Bin Code (WW)	CIE _x	CIE _y
DJ	0.322	0.324
	0.337	0.337
	0.336	0.326
	0.323	0.314
H3*	0.321	0.335
	0.329	0.342
	0.329	0.331
	0.322	0.324
H4*	0.321	0.346
	0.329	0.354
	0.329	0.342
	0.321	0.335
J3*	0.329	0.342
	0.337	0.349
	0.337	0.337
	0.330	0.331
J4*	0.329	0.354
	0.338	0.362
	0.337	0.349
	0.329	0.342
EH	0.320	0.352
	0.338	0.368
	0.338	0.362
	0.321	0.346

*Sub-bins within ANSI defined quadrangles per ANSI C78.377-2008

Product Shipping & Labeling Information

All SBT-90 products are packaged and labeled with their respective bin as outlined in the tables on pages 3 & 4. When shipped, each package will only contain one bin. The part number designation is as follows:

SBT-90 White					
SBT	90	WNNX	F71	FF	WW
Product Family	Chip Area	Color	Package Configuration	Flux Bin	Chromaticity Bin
Surface Mount (window)	9.0 mm ²	CCT & CRI See Note 1 below	Internal Code	See page 3 for bins	See page 3 for bins

Note 1: WNNX nomenclature corresponds to the following:

W = White

NN = color temperature, where:

65 corresponds to 6500K

57 corresponds to 5700K

X = color rendering index, where:

S (standard) corresponds to a typical CRI of 70

Example:

The part label SBT-90-W65S-F71-NA-G4 refers to a 6500K standard CRI white, SBT-90 emitter, with a flux range from 1,590 to 1,710 lumens and a chromaticity value within the box defined by the four points (0.313, 0.329), (0.321, 0.337), (0.321, 0.348), (0.312, 0.339).

SBT-90- Red					
SBT	90	R	F75	FF	WW
Product Family	Chip Area	Color	Package Configuration	Flux Bin	Wavelength Bin
Surface Mount (window)	9.0 mm ²	R: Red	Internal Code	See bins page	See bins page

Example:

The part number SBT-90-R-F75-BK-R4 refers to a red part, with a flux range of 600 - 770 lumens and a wavelength range of 619 nm to 623 nm.

Note 2: Some flux and chromaticity bins may have limited availability. Application specific bin kits, consisting of multiple bins, may be available.

Ordering Information

Ordering Part Number ^{1,2}	Color	Description
SBT-90-W57S-F71-NA100	5700K White	White SBT-90 consisting of a 9mm ² LED on ceramic substrate
SBT-90-W65S-F71-NA100	6500K White	
SBR-90-W57S-R71-NA100	5700K White	SBR-90 evaluation module consisting of a SBT-90 surface mount device mounted on an aluminum star board
SBR-90-W65S-R71-NA100	6500K White	

Ordering Part Number ²	Color	Description
SBT-90-R-F75-HN100	Red	Red SBT-90 consisting of a 9 mm ² LED on a ceramic substrate
SBR-90-R-R75-HN100	Red	SBR-90 evaluation module consisting of a SBT-90 surface mount device mounted on an aluminum star board

Note 1: NA100 - denotes a bin kit comprising of all flux bins with a minimum flux of 1,590 lumens and chromaticity bins at the 6500K color point.

Note 2: For ordering information on all available bin kits, please see PDS-001788: SBT-90 Binning & Labeling document.

SBT- 90- Electrical Characteristics¹

White				
Drive Condition ²		9.0 A		
Parameter	Symbol	Values at Test Currents		Unit
Current Density	j	1.0		A/mm ²
Forward Voltage	V _F	3.5		V

Common Characteristics

Parameter	Symbol	White	Red	Unit
Emitting Area		9.0	9.0	mm ²
Emitting Area Dimensions		3 x 3	3 x 3	mm
Forward Voltage Temperature Coefficient ³		-2.45	-1.3	mV/C
Thermal Coefficient of Photometric Flux			-0.96	%/C

Absolute Maximum Ratings

Parameter	Symbol	White	Red	Unit
Absolute Minimum Operating Current		0.2	0.2	A
Maximum Current ⁴		13.5	13.5	A
Maximum Junction Temperature ⁵	T _{j-max}	150	125	°C
Storage Temperature Range		-40/+100	-40/+100	°C

Note 1: All ratings are based on operation at room temperature.

Note 2: Listed drive conditions are typical for common applications. SBT-90 devices can be driven at currents ranging from 1A to 13.5A and at duty cycles ranging from 1% to 100%. Drive current and duty cycle should be adjusted as necessary to maintain the junction temperature desired to meet application lifetime requirements.

Note 3: Forward voltage temperature coefficient at current density of 1 A/mm² and heat sink temperature of 40°C. Contact Luminus for value at other drive conditions.

Note 4: Luminus SBT-90 LEDs are designed for operation to an absolute maximum forward drive current density of 1.5 A/mm². Product lifetime data is specified at recommended forward drive currents. Sustained operation at absolute maximum currents will result in a reduction of device lifetime compared to recommended forward drive currents. Actual device lifetimes will also depend on junction temperature. Refer to the lifetime derating curves for further information. In pulsed operation, rise time from 10-90% of forward current should be larger than 0.5 microseconds.

Note 5: Lifetime is dependent on LED junction temperature. Thermal calculations based on input power and thermal management system should be performed to ensure T_j is maintained below T_{j-max} rating or life will be reduced. Refer to lifetime plots on page 9 and lifetime and reliability application note for further information.

SBT-90-R Optical & Electrical Characteristics

Red			
Drive Condition ²		13.5A	
Parameter	Symbol	Values ³	Unit
Current Density	j	1.5	A/mm ²
Forward Voltage	V _{F min}	2.3	V
	V _F	2.7	V
	V _{F max}	3.6	V
Luminous Flux ⁴	Φ _{V,typ}	1350	lm
Dominant Wavelength ⁵	λ _d	620	nm
FWHM	Δλ _{1/2}	18	nm
Chromaticity Coordinates ^{6,7}	x	0.695	-
	y	0.305	-

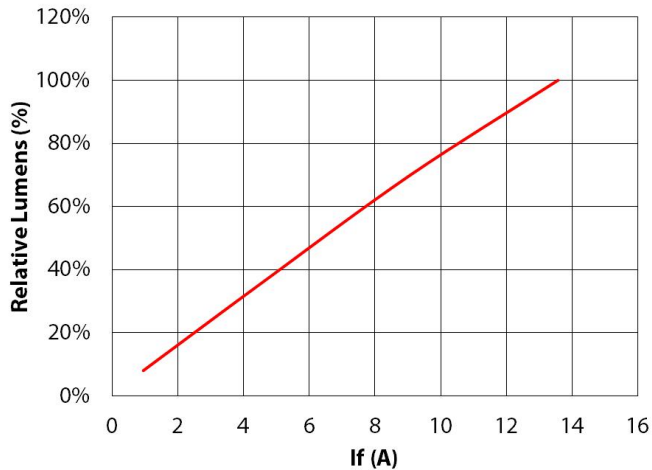
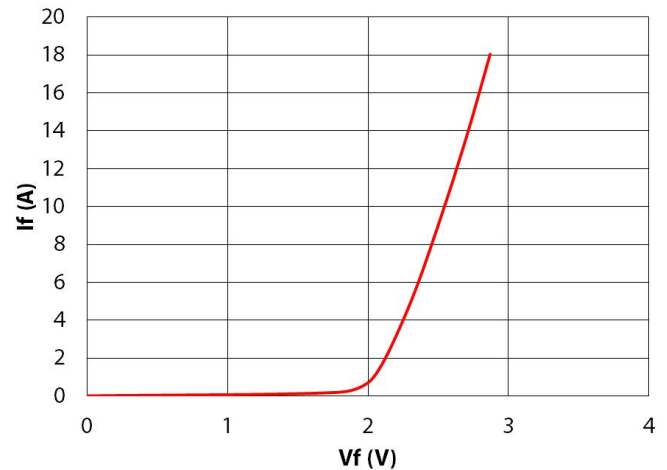
Relative Luminous Flux vs. Forward Current¹

Forward Current vs. Forward Voltage

Note 1: All ratings are based on a junction test temperature Tj = 25°C. See Thermal Resistance section for Tj definition.

Note 2: Listed drive conditions are typical for common applications. SBT-90 devices can be driven at currents ranging from <1 A to 13.5 A and at duty cycles ranging from 1% to 100%. Drive current and duty cycle should be adjusted as necessary to maintain the junction temperature desired to meet application lifetime requirements.

Note 3: Unless otherwise noted, values listed are typical. Devices are production tested and specified at 13.5A. Other values are for reference only.

Note 4: Total flux from emitting area at listed dominant wavelength. Reported performance is included to show trends for a selected power level. For specific minimum and maximum values, use bin tables. For product roadmap and future performance of devices, contact Luminus.

Note 5: Minimum and Maximum Dominant Wavelengths are based on typical values +/- 5nm for Red.

Note 6: In CIE 1931 chromaticity diagram coordinates, normalized to X+Y+Z=1.

Note 7: For reference only.

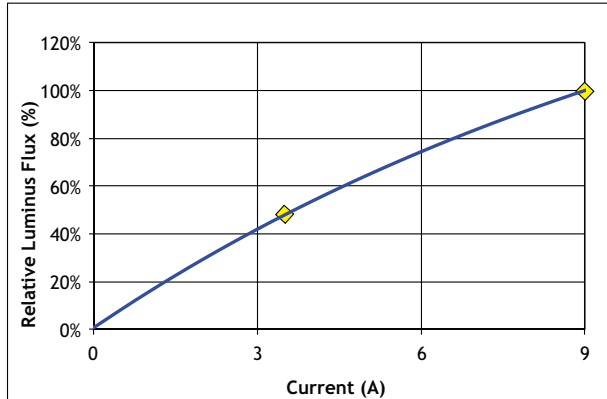
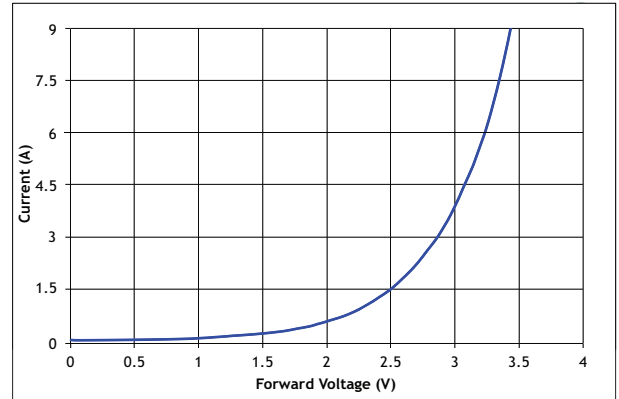
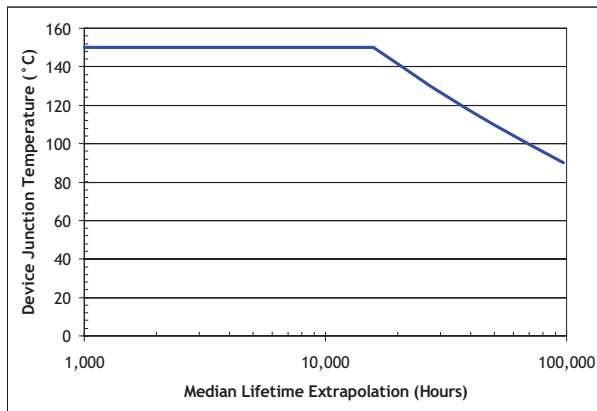
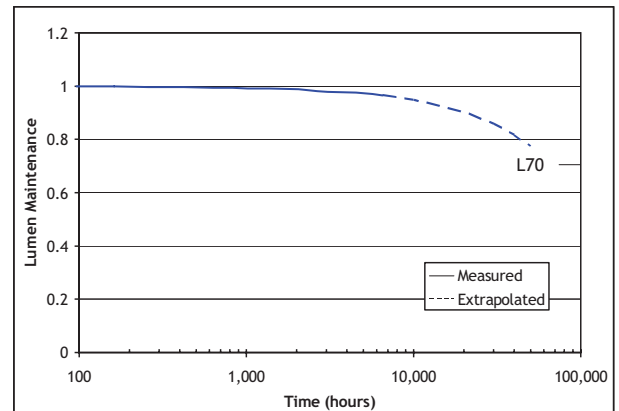
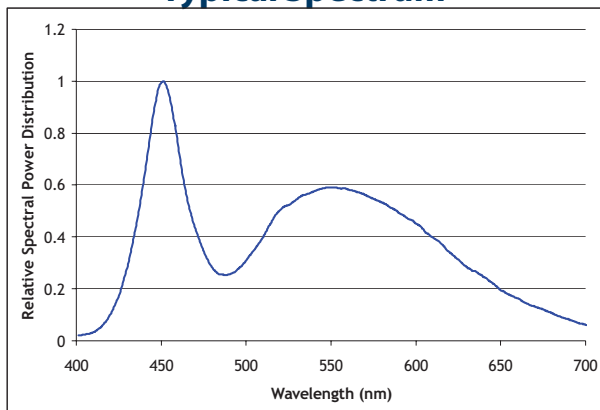
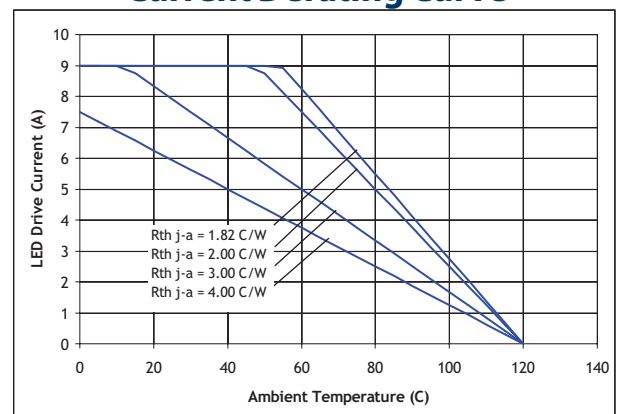
SBT-90-W Characteristics
Relative Output Flux vs. Forward Current¹

Forward Current vs. Forward Voltage

Median Lifetime²

Lumen Maintenance vs. Time³

Typical Spectrum⁴

Current Derating Curve

Note 1: Yellow squares indicate typical operating conditions.

Note 2: Median expected lifetime in dependence of junction temperature at 0.35 A/mm² in continuous operation. Lifetime defined as time to 70% of initial intensity. Based on lifetime test data of uncoated GaN devices at this time. Data can be used to model failure rate over typical product lifetime (contact Luminus for lifetime reliability test data for 1A/mm² condition).

Note 3: Lumen maintenance in dependence of time at 0.35 A/mm² in continuous operation with junction temperatures of 100 °C. Lumen maintenance calculation doesn't consider open and short circuit failure modes into account.

Note 4: Typical spectrum at current density of 0.35 A/mm² in continuous operation.

Typical Radiation Patterns

Typical Polar Radiation Pattern for White

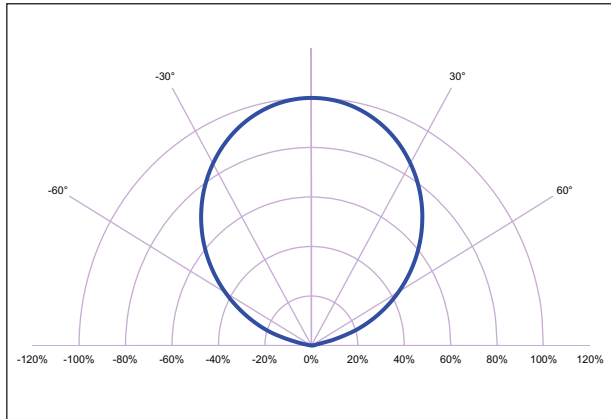

Typical Angular Radiation Pattern for White

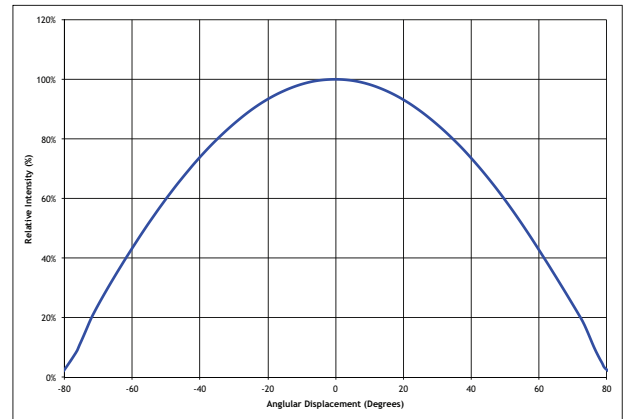

Thermal Resistance

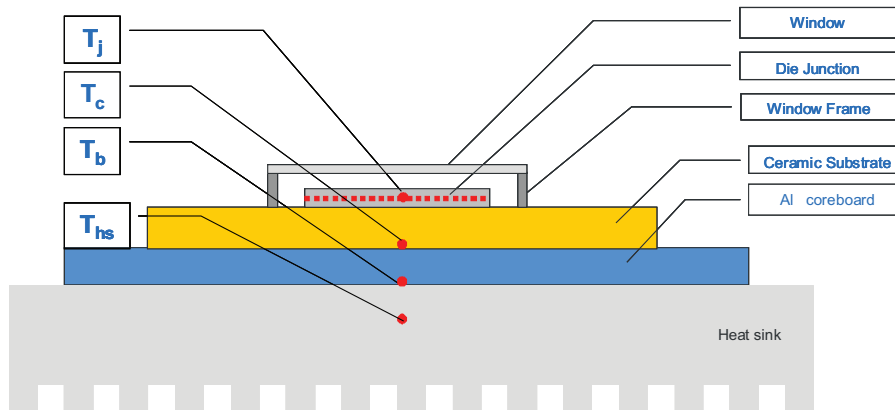

Typical Thermal Resistance :

R_{j-c}^1	0.5 °C/W
R_{j-b}^1	1.2 °C/W
R_{j-hs}^2	1.4 °C/W

Note 1: Thermal resistance values are based on FEA model results correlated to measured $R_{\theta j-hs}$ data.

Note 2: Thermal resistance is measured using a SAC305 solder, a Bergquist Al-clad MCPCB, and eGraf 1205 thermal interface material.

SBT-90-R Output vs. Temp., Lifetime and Spectrum

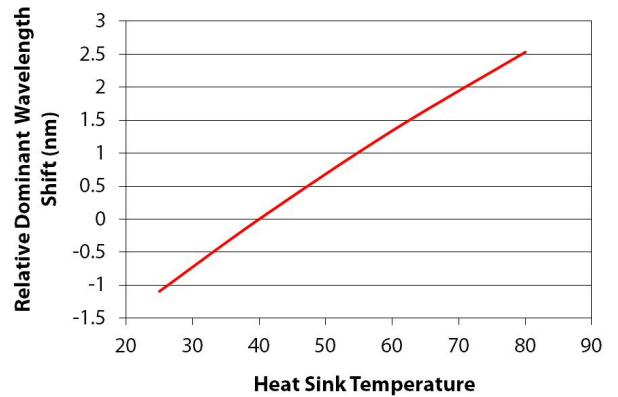
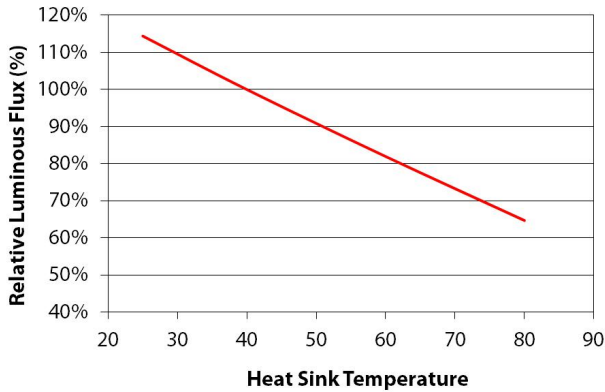

Median Lifetime Estimate vs. Tj¹

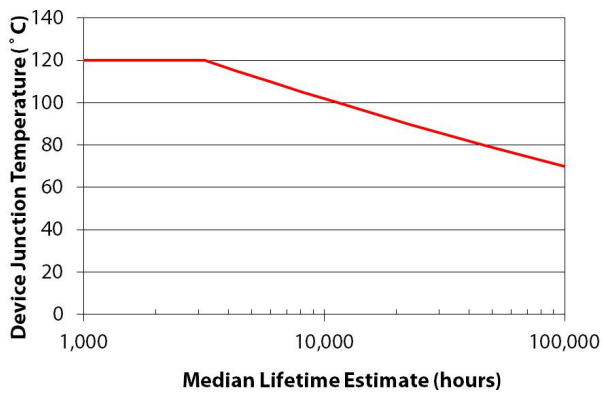

Lumen Maintenance²

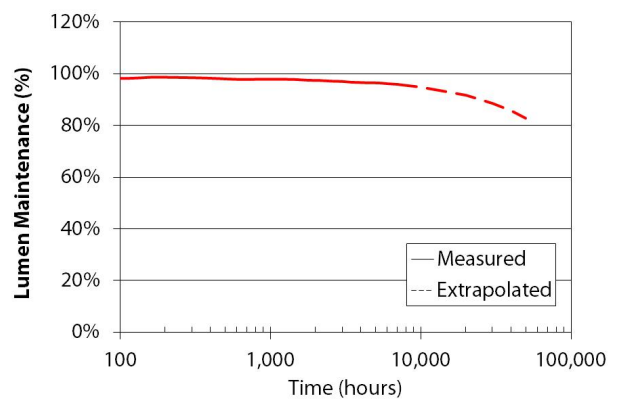

Typical Spectrum³

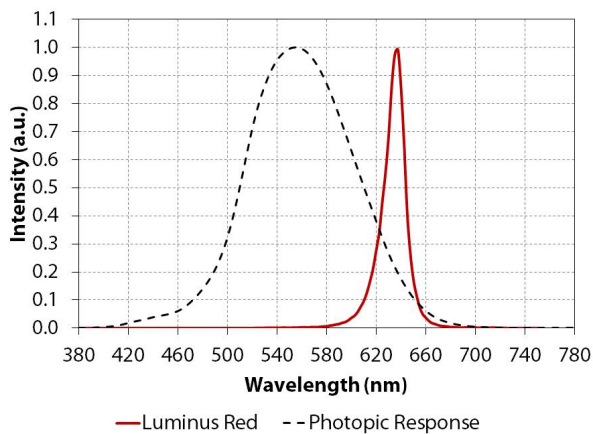

Angular Distribution

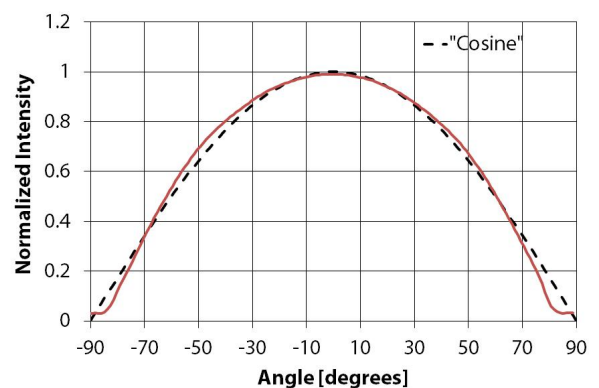

Note 1. Median lifetime estimate as a function of junction temperature at 1.5A/mm² in continuous operation. Lifetime defined as time to 70% of initial intensity. Based on preliminary lifetime test data. Data can be used to model failure rate over typical product lifetime.

Note 2. Lumen maintenance vs. time at 1.5A/mm² in continuous operation, junction temperature equal to 25°C.

Note 3. Typical spectrum at current density of 1.5 A/mm² in continuous operation.

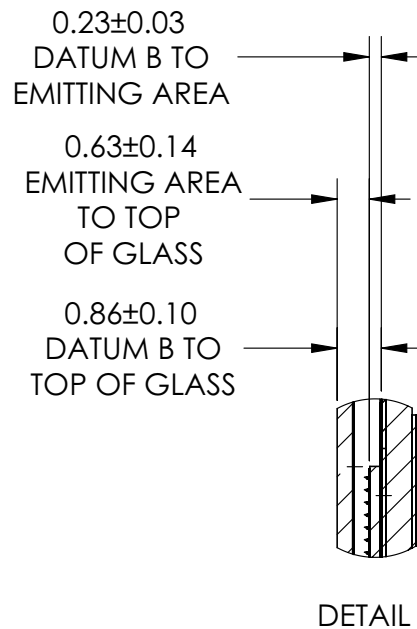
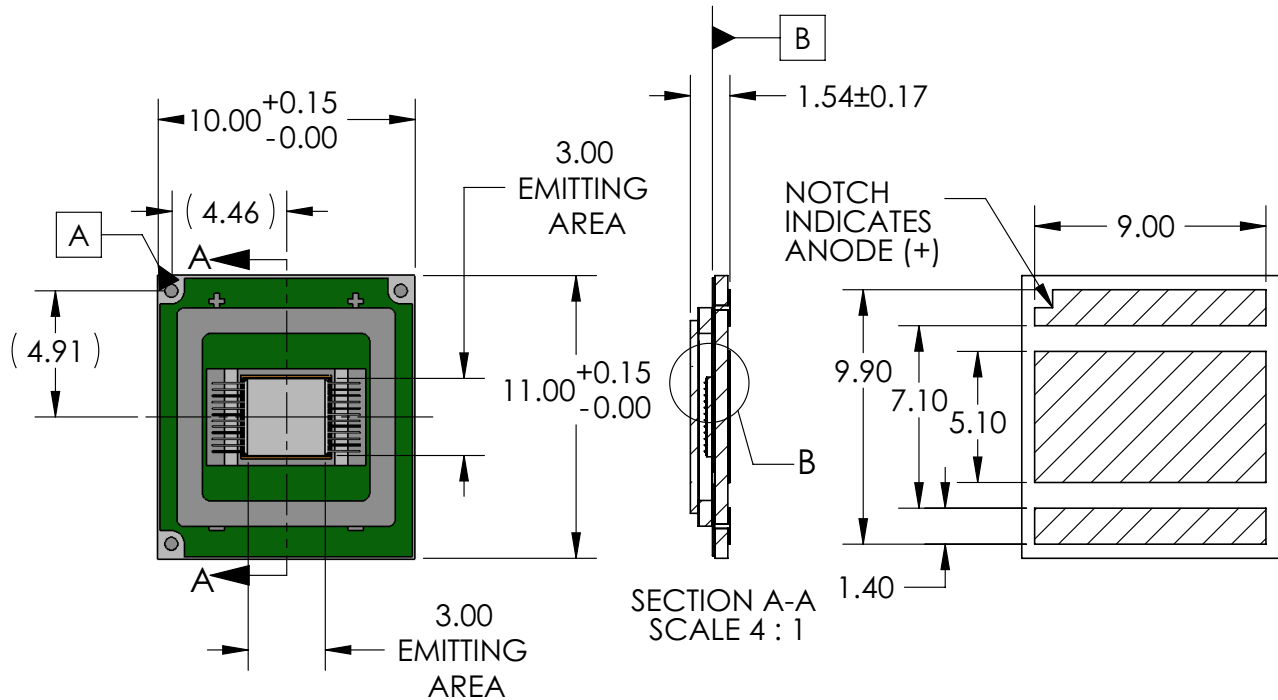
Mechanical Dimensions – SBT-90 Emitter
DIMENSIONS IN MILLIMETERS

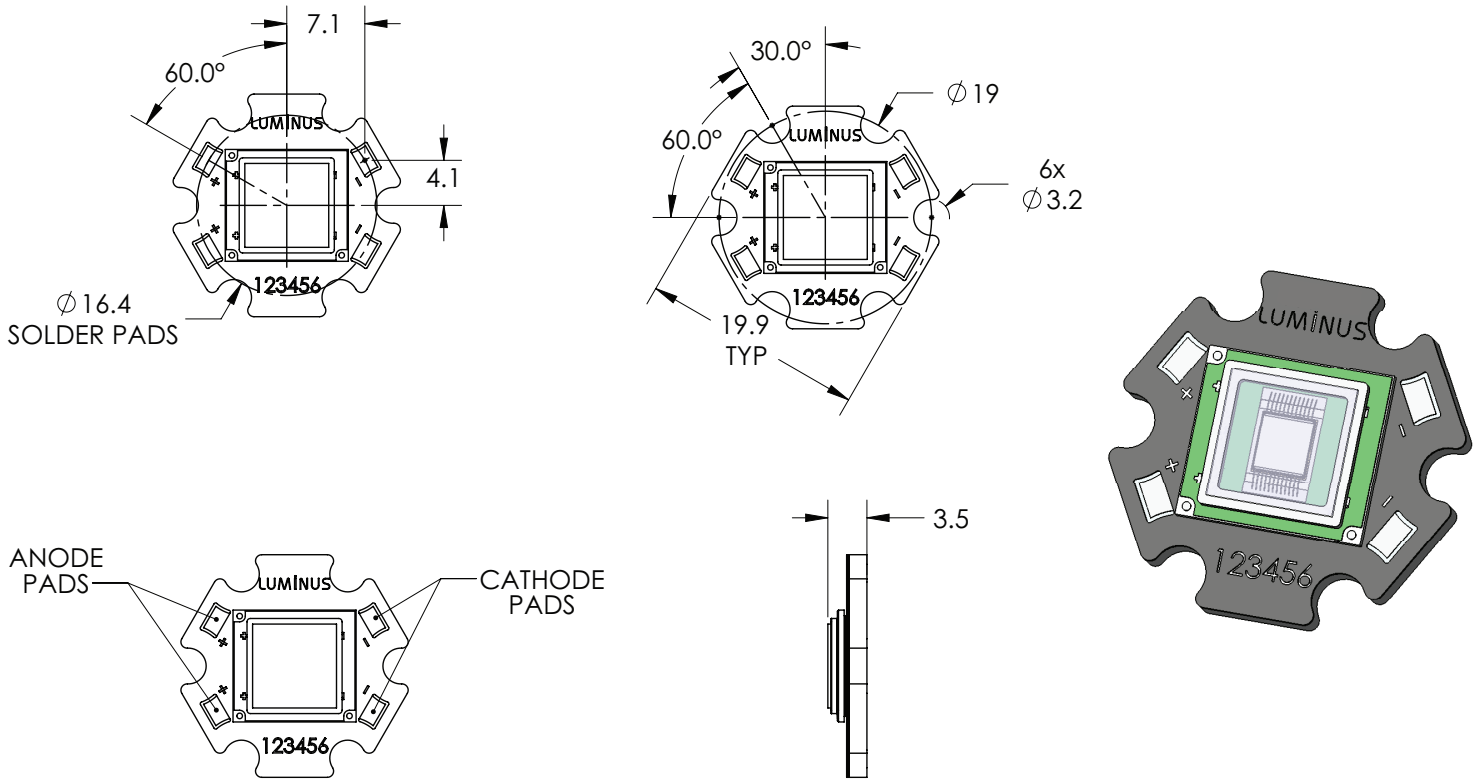
Mechanical Dimensions – SBT-90 Star Board

Note 1: Tolerances per IPC-610, Class 2

Note 2: For detail drawing of SBT-90, please see DWG-001553

Note 3: Recommended mounting screw: M3 or #4

Note 4: All dimensions in millimeters

Note 5: All anode pads on board are interconnected. All cathode pads on board are interconnected

Solder Profile

SAC 305 Reflow Profile Window For Low Density Boards

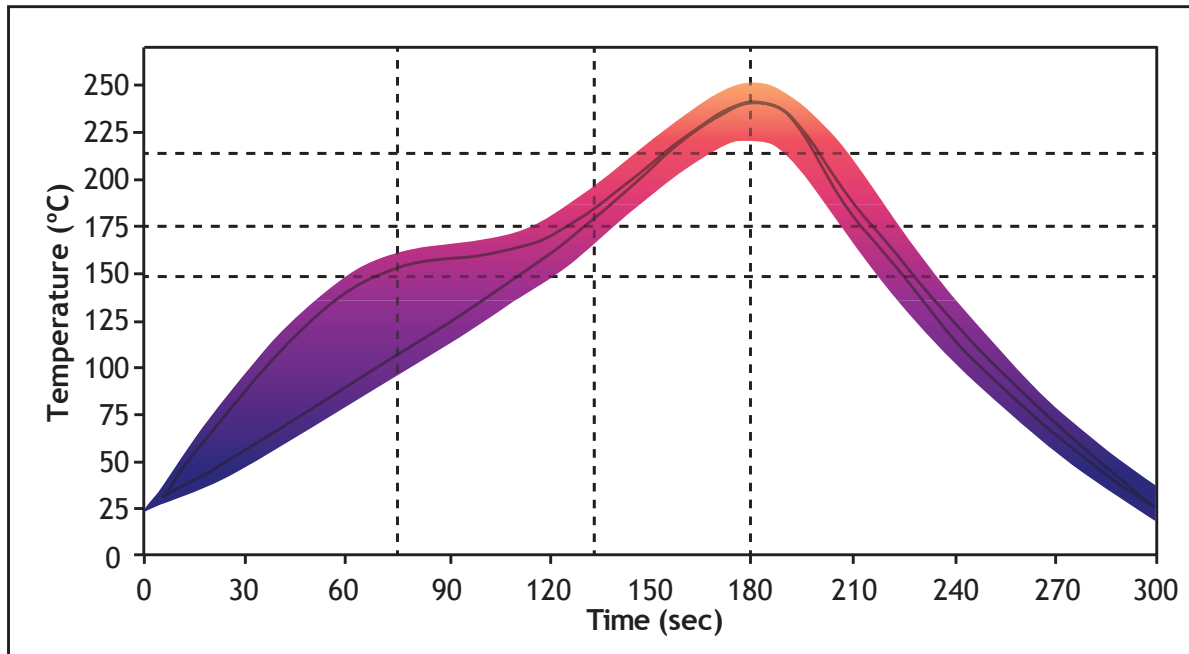

Lead free solder guideline for low density boards

Solder Profile Stage	Lead-Free Solder
Profile length, Ambient to Peak	2.75 - 3.5 minutes
Time above 217° C	30 - 60 seconds
Cooldown Rate	≤4° C/sec
Cooldown duration	45 ± 15 sec

Note 1: Temperatures are taken and monitored at the component copper layer

Note 2: Optimum profile may differ due to oven type, circuit board or assembly layout

Note 3: Recommended lead free, no-clean solder: AIM NC254-SAC305

Note 4: Refer to APN-001473 soldering and handling application note for additional solder profiles and details

Note 5: MSL- 1 Level

History of Changes

Rev	Date	Description of Change
15	06/16/2016	Added SBT-90-W57S Product Editorial Fixes
14	07/20/2016	Updated graphs on page 8 and 11
13	06/04/2016	Clarified minimum operating current
		Updated thermal resistance values
		Editorial Changes

The products, their specifications and other information appearing in this document are subject to change by Luminus Devices without notice. Luminus Devices assumes no liability for errors that may appear in this document, and no liability otherwise arising from the application or use of the product or information contained herein. None of the information provided herein should be considered to be a representation of the fitness or suitability of the product for any particular application or as any other form of warranty. Luminus Devices' product warranties are limited to only such warranties as accompany a purchase contract or purchase order for such products. Nothing herein is to be construed as constituting an additional warranty. No information contained in this publication may be considered as a waiver by Luminus Devices of any intellectual property rights that Luminus Devices may have in such information. Big Chip LEDs™ is a registered trademark of Luminus Devices, Inc., all rights reserved.

This product is protected by U.S. Patents 6,831,302; 7,074,631; 7,083,993; 7,084,434; 7,098,589; 7,105,861; 7,138,666; 7,166,870; 7,166,871; 7,170,100; 7,196,354; 7,211,831; 7,262,550; 7,274,043; 7,301,271; 7,341,880; 7,344,903; 7,345,416; 7,348,603; 7,388,233; 7,391,059 Patents Pending in the U.S. and other countries.

Looking for pricing, stock, or lifecycle information?

Click below to explore more details on WIN SOURCE:

- [⊖ View SBT-90-W65S-F71-NA100 on WIN SOURCE](#)
- [⊖ Luminus Devices Inc. Information](#)

Optimize Your Supply Chain with WIN SOURCE Solutions

- ✓ Global Sourcing Solution
- ✓ Obsolete Management
- ✓ Cost Control Management
- ✓ Shortage Management
- ✓ Alternative Solution
- ✓ Excess Inventory Management