



# THE DATASHEET OF S8X8TSRP



### SxX8xSx EV Series



#### Main Features

Symbol	Value	Unit
$I_{T(RMS)}$	0.8	A
$V_{DRM}/V_{RRM}$	400, 600, or 800	V
$I_{GT}$	5 to 200	$\mu$ A

#### Applications

The SxX8xSx EV series is specifically designed for GFCI (Ground Fault Circuit Interrupter) and gas ignition applications.

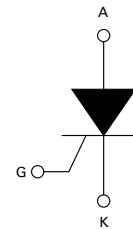
#### Description

This new component series offers high static dv/dt and low turn off time ( $t_q$ ) sensitive SCR with its small die planar construction design. It is specifically designed for GFCI (Ground Fault Circuit Interrupter) and Gas Ignition applications. All SCRs junctions are glass-passivated to ensure long term reliability and parametric stability.

#### Features

- RoHS compliant and Halogen-Free
- Thru-hole and surface mount packages
- Surge current capability > 10Amps
- Blocking voltage ( $V_{DRM}/V_{RRM}$ ) capability - up to 800V
- High dv/dt noise immunity
- Improved turn-off time ( $t_q$ ) < 25  $\mu$ sec
- Sensitive gate for direct microprocessor interface

#### Schematic Symbol



#### Absolute Maximum Ratings

Symbol	Parameter	Value	Unit
$I_{T(RMS)}$	RMS on-state current (full sine wave)	TO-92 $T_c = 55^\circ\text{C}$	0.8 A
		SOT-89 $T_c = 60^\circ\text{C}$	0.8 A
		SOT-223 $T_L = 60^\circ\text{C}$	0.8 A
$I_{T(AV)}$	Average on-state current	TO-92 $T_c = 55^\circ\text{C}$	0.51 A
		SOT-89 $T_c = 60^\circ\text{C}$	0.51 A
		SOT-223 $T_L = 60^\circ\text{C}$	0.51 A
$I_{TSM}$	Non repetitive surge peak on-state current (Single cycle, $T_{j\text{initial}} = 25^\circ\text{C}$ )	TO-92 SOT-89 SOT-223 F = 50Hz	8 A
		F = 60Hz	10 A
$I^2t$	$I^2t$ Value for fusing	$t_p = 10$ ms F = 50 Hz	0.32 A <sup>2</sup> s
		$t_p = 8.3$ ms F = 60 Hz	0.41 A <sup>2</sup> s
di/dt	Critical rate of rise of on-state current $I_G = 10$ mA	TO-92 SOT-89 SOT-223 $T_J = 125^\circ\text{C}$	50 A/ $\mu$ s
$I_{GM}$	Peak Gate Current	$t_p = 10$ $\mu$ s $T_J = 125^\circ\text{C}$	1.0 A
$P_{G(AV)}$	Average gate power dissipation	— $T_J = 125^\circ\text{C}$	0.1 W
$T_{stg}$	Storage junction temperature range	—	-40 to 150 $^\circ\text{C}$
$T_J$	Operating junction temperature range	—	-40 to 125 $^\circ\text{C}$

### Electrical Characteristics ( $T_J = 25^\circ\text{C}$ , unless otherwise specified)

Symbol	Description	Test Conditions	Limit	Value			Unit
				SxX8yS1	SxX8yS2	SxX8yS	
$I_{GT}$	DC Gate Trigger Current	$V_D = 6\text{V}$ $R_L = 100\ \Omega$	MIN.	0.5	1	15	$\mu\text{A}$
			MAX.	5	50	200	$\mu\text{A}$
$V_{GT}$	DC Gate Trigger Voltage	$V_D = 6\text{V}$ $R_L = 100\ \Omega$	MAX.	0.8			V
$V_{GRM}$	Peak Reverse Gate Voltage	$I_{RG} = 10\ \mu\text{A}$	MIN.	5			V
$I_H$	Holding Current	$R_{GK} = 1\ \text{k}\Omega$ Initial Current = 20mA	MAX.	5			mA
(dv/dt)s	Critical Rate-of-Rise of Off-State Voltage	$T_J = 125^\circ\text{C}$ $V_D = V_{DRM} / V_{RRM}$ Exp. Waveform $R_{GK} = 1\ \text{k}\Omega$	MIN.	75			V/ $\mu\text{s}$
$V_{GD}$	Gate Non-Trigger Voltage	$V_D = V_{DRM}$ $R_{GK} = 1\ \text{k}\Omega$ $T_J = 125^\circ\text{C}$	MIN.	0.2			V
$t_q$	Turn-Off Time	$T_J = 25^\circ\text{C} @ 600\ \text{V}$ $R_{GK} = 1\ \text{k}\Omega$	MAX.	30	25	25	$\mu\text{s}$
$t_{gt}$	Turn-On Time	$I_G = 10\ \text{mA}$ PW = 15 $\mu\text{sec}$ $I_T = 1.6\ \text{A(pk)}$	TYP.	2.0	2.0	2.0	$\mu\text{s}$

Note: x = voltage/100, y = package

### Static Characteristics ( $T_J = 25^\circ\text{C}$ , unless otherwise specified)

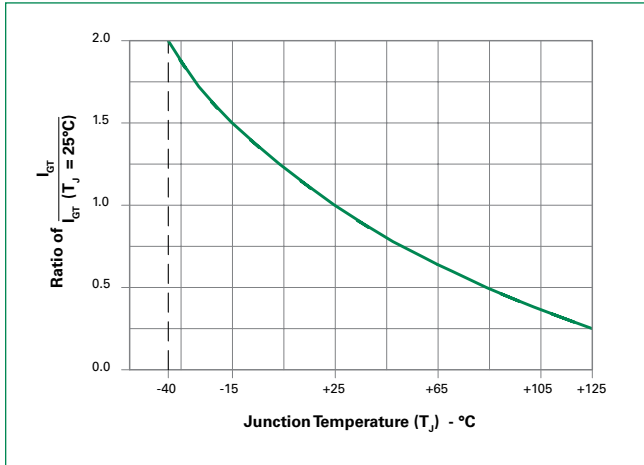
Symbol	Description	Test Conditions	Limit	Value	Unit
$V_{TM}$	Peak On-State Voltage	$I_{TM} = 1.6\ \text{A (pk)}$	MAX.	1.70	V
$I_{DRM}$	Off-State Current, Peak Repetitive	$T_J = 25^\circ\text{C} @ V_D = V_{DRM}$ $R_{GK} = 1\ \text{k}\Omega$	MAX.	3	$\mu\text{A}$
		$T_J = 125^\circ\text{C} @ V_D = V_{DRM}$ $R_{GK} = 1\ \text{k}\Omega$	MAX.	500	$\mu\text{A}$

### Thermal Resistances

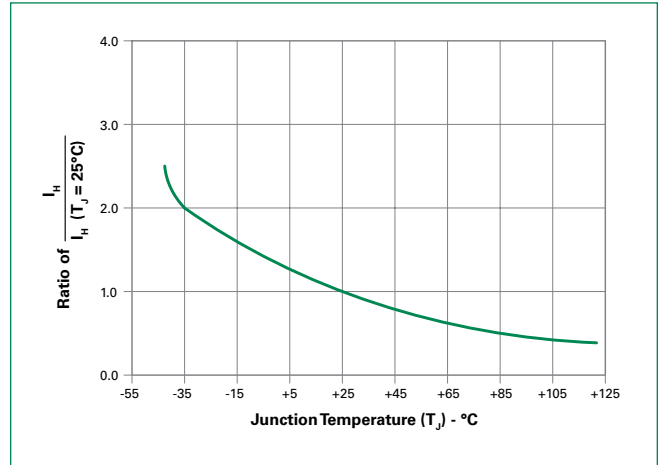
Symbol	Description	Test Conditions	Value	Unit	
$R_{\theta JC}$	Junction to case (AC)	$I_T = 0.8\ \text{A}_{(RMS)}^1$	TO-92	75	$^\circ\text{C/W}$
			SOT-223	30	$^\circ\text{C/W}$
			SOT-89	50	$^\circ\text{C/W}$
$R_{\theta JA}$	Junction to ambient	$I_T = 0.8\ \text{A}_{(RMS)}^1$	TO-92	150	$^\circ\text{C/W}$
			SOT-223	60	$^\circ\text{C/W}$
			SOT-89	90	$^\circ\text{C/W}$

<sup>1</sup> 60Hz AC resistive load condition, 100% conduction.

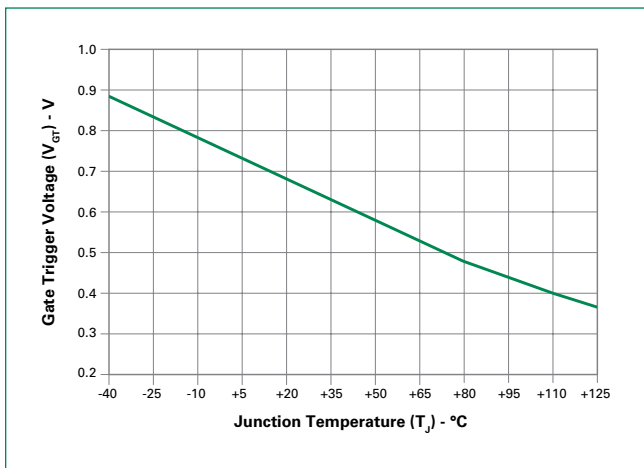
**Figure 1: Normalized DC Gate Trigger Current For All Quadrants vs. Junction Temperature**



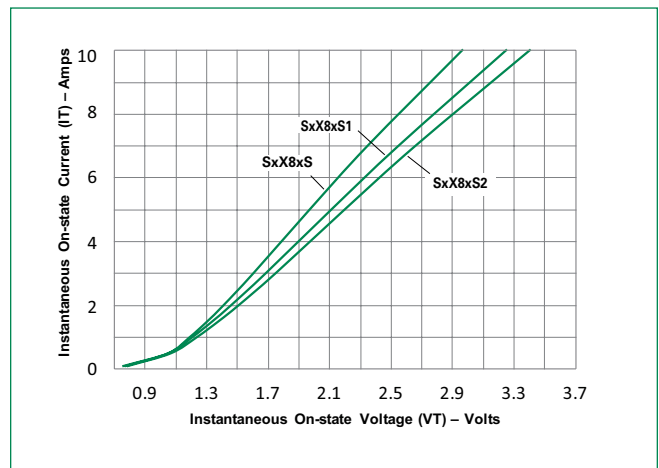
**Figure 2: Normalized DC Holding Current vs. Junction Temperature**



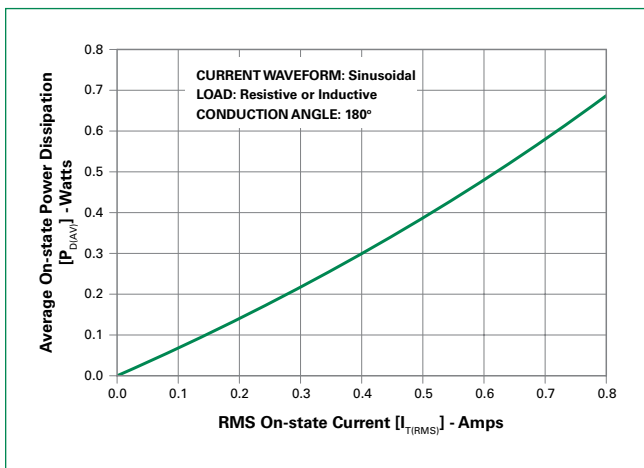
**Figure 3: Normalized DC Gate Trigger Voltage vs. Junction Temperature**



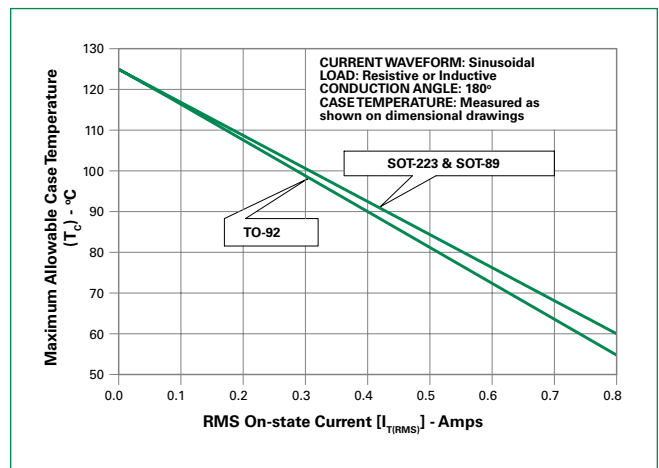
**Figure 4: On-State Current vs. On-State Voltage (Typical)**



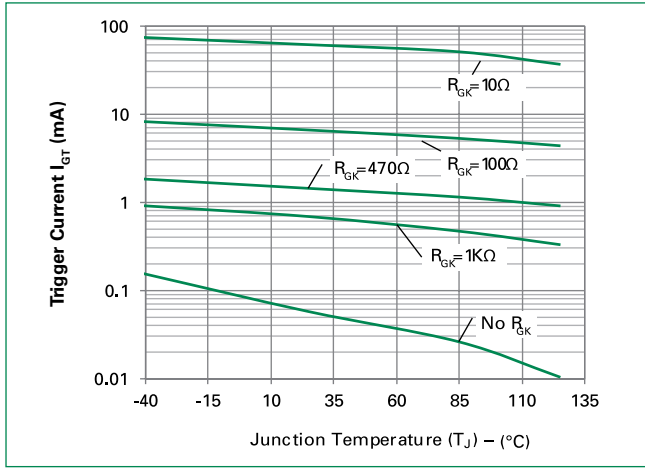
**Figure 5: Power Dissipation (Typical) vs. RMS On-State Current**



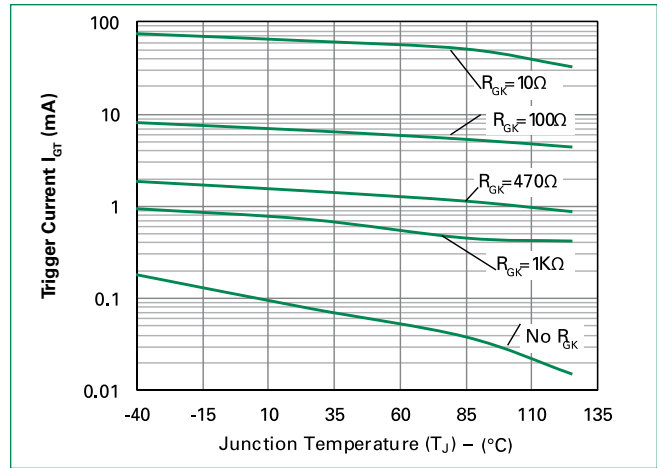
**Figure 6: Maximum Allowable Case Temperature vs. On-State Current**



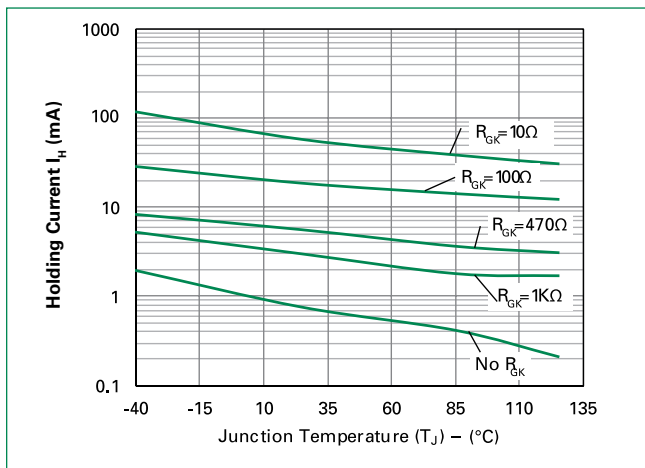
**Figure 7-1: Typical DC Gate Trigger Current with  $R_{GK}$  vs. Junction Temperature for S6X8BS**



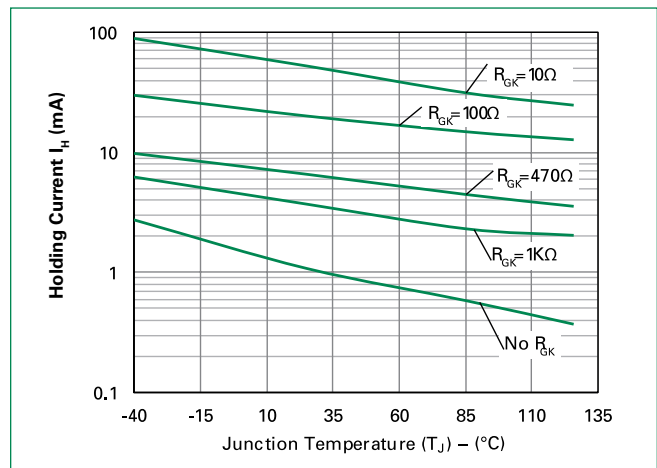
**Figure 7-2: Typical DC Gate Trigger Current with  $R_{GK}$  vs. Junction Temperature for S8X8ESRP**



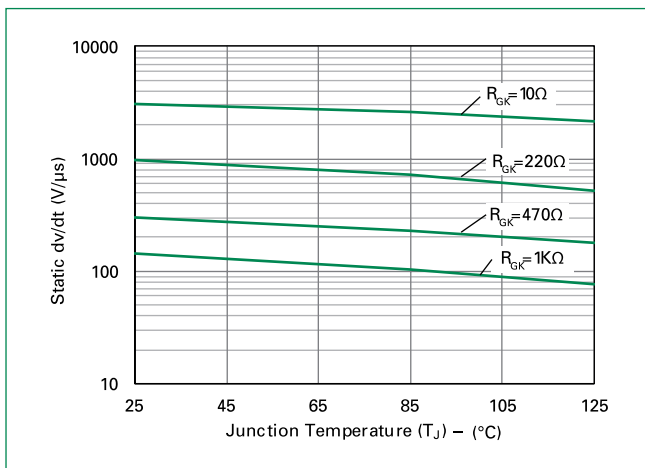
**Figure 8-1: Typical DC Holding Current with  $R_{GK}$  vs. Junction Temperature for S6X8BS**



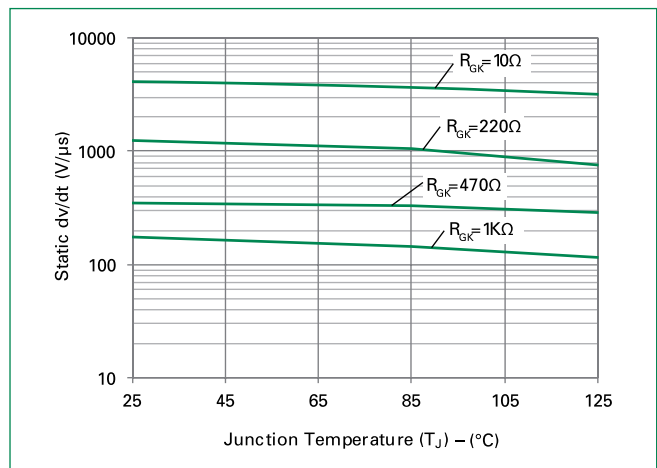
**Figure 7-2: Typical DC Holding Current with  $R_{GK}$  vs. Junction Temperature for S8X8ESRP**



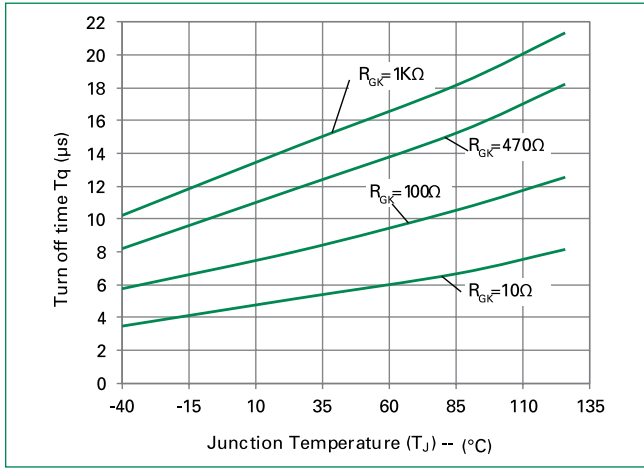
**Figure 9-1: Typical DC Static dv/dt with  $R_{GK}$  vs. Junction Temperature for S6X8BS**



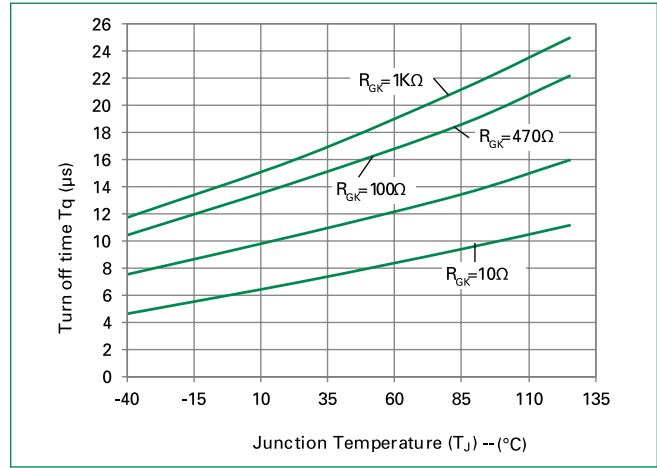
**Figure 9-2: Typical DC Static dv/dt with  $R_{GK}$  vs. Junction Temperature for S8X8ESRP**



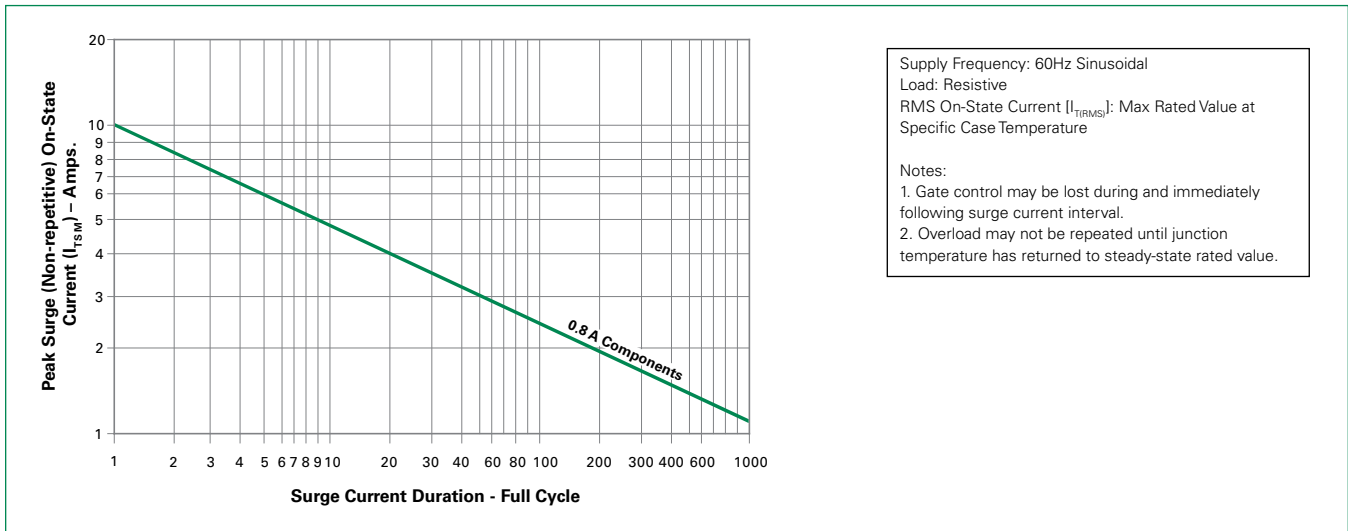
**Figure 10-1: Typical DC turn off time with  $R_{GK}$  vs. Junction Temperature for S6X8BS**



**Figure 10-2: Typical DC turn off time with  $R_{GK}$  vs. Junction Temperature for S8X8ESRP**

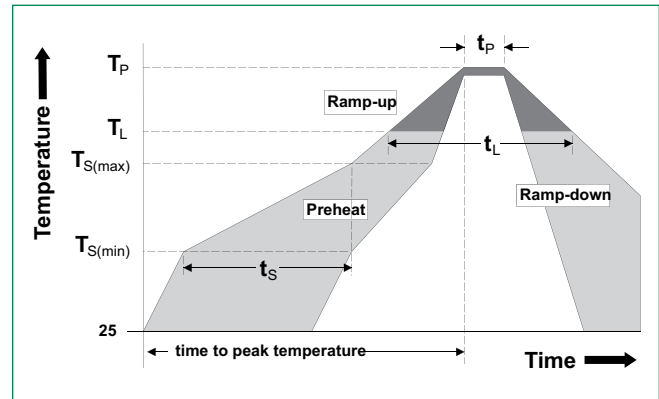


**Figure 11: Surge Peak On-State Current vs. Number of Cycles**



### Soldering Parameters

<b>Reflow Condition</b>		Pb – Free assembly
<b>Pre Heat</b>	- Temperature Min ( $T_{s(min)}$ )	150°C
	- Temperature Max ( $T_{s(max)}$ )	200°C
	- Time (min to max) ( $t_s$ )	60 – 180 secs
<b>Average ramp up rate (Liquidus Temp) (<math>T_L</math>) to peak</b>		5°C/second max
<b><math>T_{s(max)}</math> to <math>T_L</math> - Ramp-up Rate</b>		5°C/second max
<b>Reflow</b>	- Temperature ( $T_L$ ) (Liquidus)	217°C
	- Time (min to max) ( $t_s$ )	60 – 150 seconds
<b>Peak Temperature (<math>T_p</math>)</b>		260 <sup>+0/-5</sup> °C
<b>Time within 5°C of actual peak Temperature (<math>t_p</math>)</b>		20 – 40 seconds
<b>Ramp-down Rate</b>		5°C/second max
<b>Time 25°C to peak Temperature (<math>T_p</math>)</b>		8 minutes Max.
<b>Do not exceed</b>		280°C



### Additional Information



Datasheet



Resources



Samples

### Physical Specifications

<b>Terminal Finish</b>	100% Matte Tin-plated.
<b>Body Material</b>	UL Recognized compound meeting flammability rating V-0
<b>Lead Material</b>	Copper Alloy

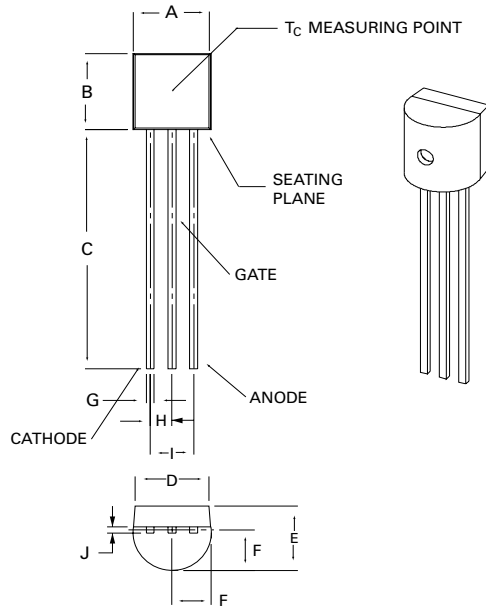
### Design Considerations

Careful selection of the correct component for the application's operating parameters and environment will go a long way toward extending the operating life of the Thyristor. Good design practice should limit the maximum continuous current through the main terminals to 75% of the component rating. Other ways to ensure long life for a power discrete semiconductor are proper heat sinking and selection of voltage ratings for worst case conditions. Overheating, overvoltage (including dv/dt), and surge currents are the main killers of semiconductors. Correct mounting, soldering, and forming of the leads also help protect against component damage.

### Reliability/Environmental Tests

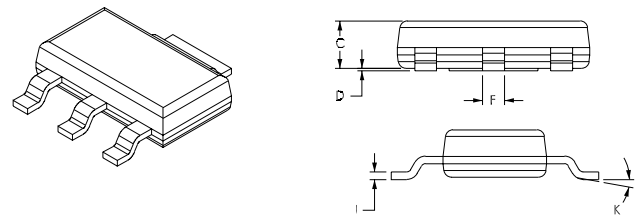
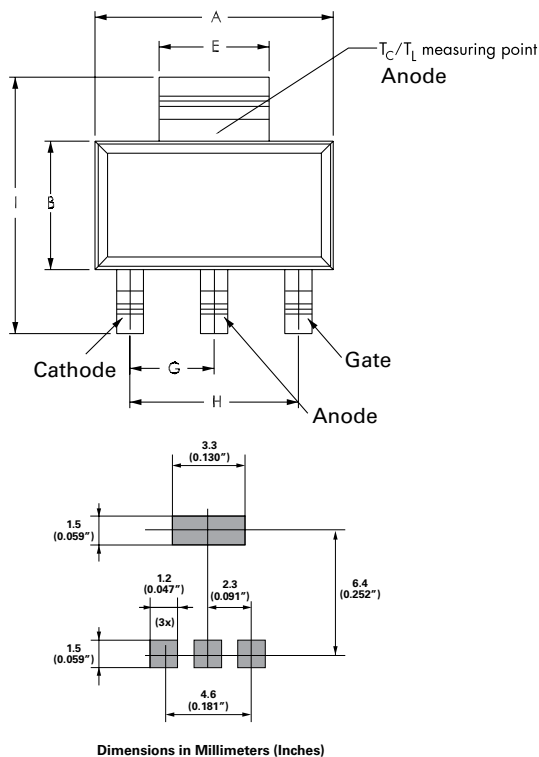
Test	Specifications and Conditions
<b>AC Blocking</b>	MIL-STD-750, M-1040, Cond A Applied Peak AC voltage @ 110°C for 1008 hours
<b>Temperature Cycling</b>	MIL-STD-750, M-1051, 100 cycles; -40°C to +150°C; 15-min dwell-time
<b>Temperature/Humidity</b>	EIA / JEDEC, JESD22-A101 1008 hours; 320V - DC: 85°C; 85% rel humidity
<b>High Temp Storage</b>	MIL-STD-750, M-1031, 1008 hours; 150°C
<b>Low-Temp Storage</b>	1008 hours; -40°C
<b>Resistance to Solder Heat</b>	MIL-STD-750 Method 2031
<b>Solderability</b>	ANSI/J-STD-002, category 3, Test A
<b>Lead Bend</b>	MIL-STD-750, M-2036 Cond E

### Dimensions – TO-92



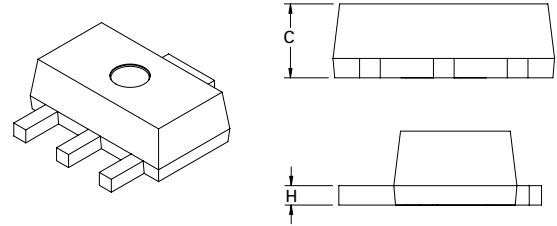
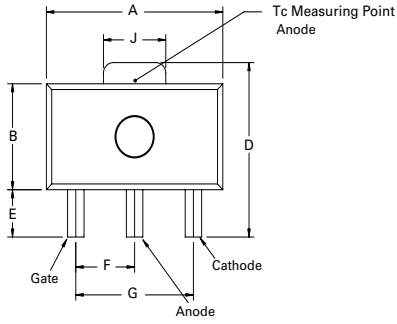
Dimension	Inches		Millimeters	
	Min	Max	Min	Max
A	0.175	0.205	4.450	5.200
B	0.170	0.210	4.320	5.330
C	0.500		12.70	
D	0.135		3.430	
E	0.125	0.165	3.180	4.190
F	0.080	0.105	2.040	2.660
G	0.016	0.021	0.407	0.533
H	0.045	0.055	1.150	1.390
I	0.095	0.105	2.420	2.660
J	0.015	0.020	0.380	0.500

### Dimensions – SOT-223

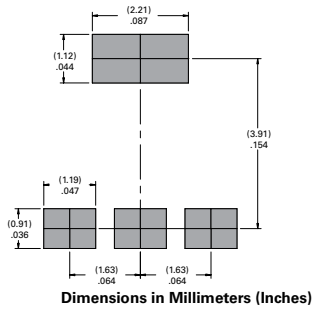


Dimensions	Inches			Millimeters		
	Min	Typ	Max	Min	Typ	Max
A	0.248	0.256	0.264	6.30	6.50	6.70
B	0.130	0.138	0.146	3.30	3.50	3.70
C	—	—	0.071	—	—	1.80
D	0.001	—	0.004	0.02	—	0.10
E	0.114	0.118	0.124	2.90	3.00	3.15
F	0.024	0.027	0.034	0.60	0.70	0.85
G	—	0.090	—	—	2.30	—
H	—	0.181	—	—	4.60	—
I	0.264	0.276	0.287	6.70	7.00	7.30
J	0.009	0.010	0.014	0.24	0.26	0.35
K	10° MAX					

### Dimensions – SOT-89



#### Pad Layout for SOT-89



Dimension	Inches			Millimeters		
	Min	Typ	Max	Min	Typ	Max
A	0.173	—	0.181	4.40	—	4.60
B	0.090	—	0.102	2.29	—	2.60
C	0.055	—	0.063	1.40	—	1.60
D	0.155	—	0.167	3.94	—	4.25
E	0.035	—	0.047	0.89	—	1.20
F	0.056	—	0.062	1.42	—	1.57
G	0.115	—	0.121	2.92	—	3.07
H	0.014	—	0.017	0.35	—	0.44
I	0.014	—	0.019	0.36	—	0.48
J	0.064	—	0.072	1.62	—	1.83

### Product Selector

Part Number	Voltage			Gate Sensitivity	Package
	400V	600V	800V		
SxX8BS	X	X	-	200 $\mu$ A	SOT-89
SxX8ES	X	X	X	200 $\mu$ A	TO-92
SxX8TS	X	X	X	200 $\mu$ A	SOT-223
SxX8BS1	X	X	-	5 $\mu$ A	SOT-89
SxX8ES1	X	X	X	5 $\mu$ A	TO-92
SxX8TS1	X	X	X	5 $\mu$ A	SOT-223
SxX8BS2	X	X	-	50 $\mu$ A	SOT-89
SxX8ES2	X	X	X	50 $\mu$ A	TO-92
SxX8TS2	X	X	X	50 $\mu$ A	SOT-223

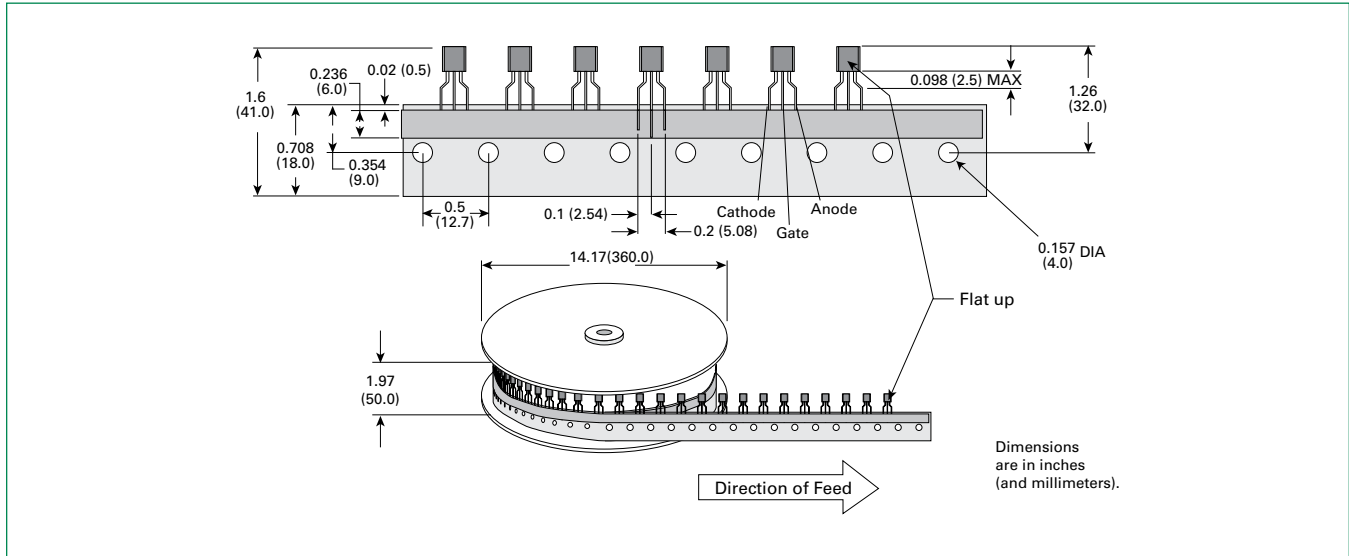
### Packing Options

Part Number	Marking	Weight	Packing Mode	Base Quantity
SxX8ESy	SxX8ESy	0.217g	Bulk	2500
SxX8ESyAP	SxX8ESy	0.217g	Ammo Pack	2000
SxX8ESyRP	SxX8ESy	0.217g	Tape & Reel	2000
SxX8TSyRP	SxX8TSy	0.120g	Tape & Reel	1000
SxX8BSyRP	xX8y	0.053g	Tape & Reel	1000
SxX8BSyRP1	xX8y	0.053g	Tape & Reel	1000

Note: x = voltage/100, y = gate sensitivity

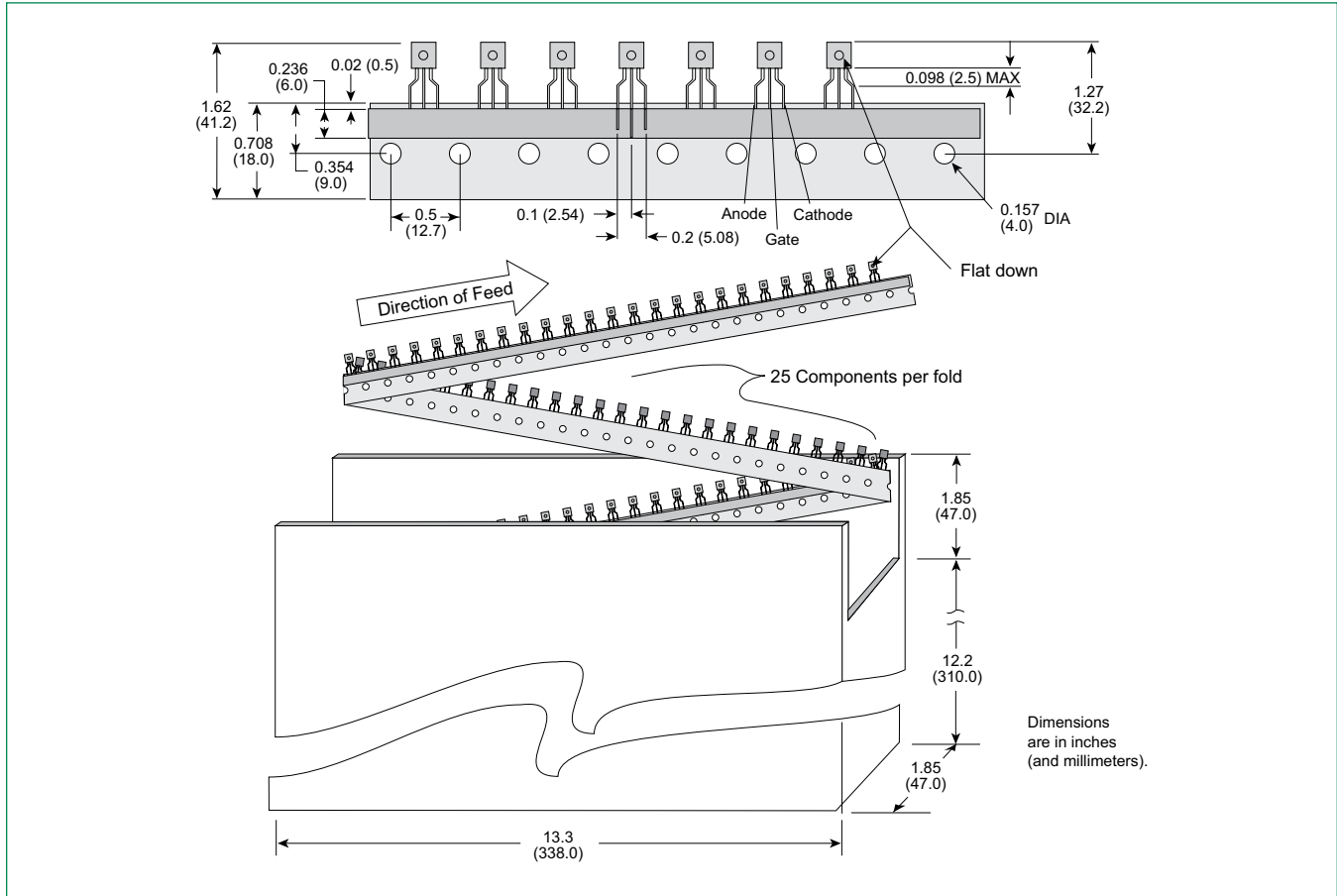
### TO-92 (3-lead) Reel Pack (RP) Radial Led Specifications

Meets all EIA-468-C Standards

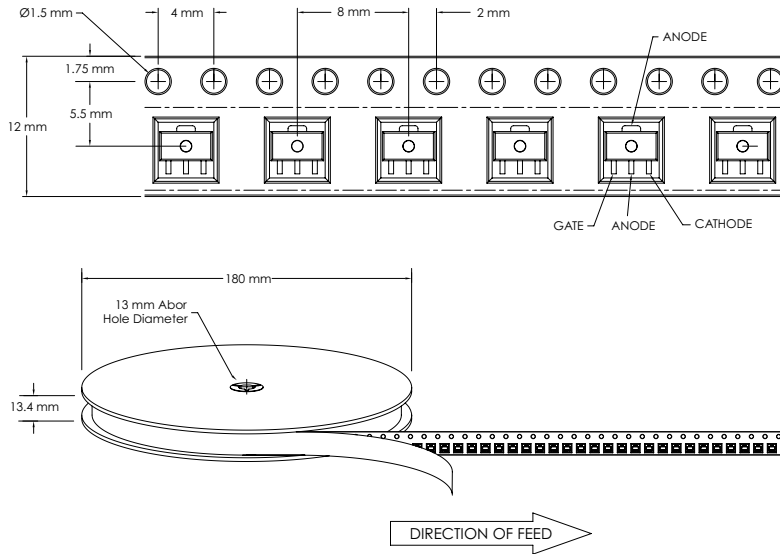


### TO-92 (3-lead) Ammo Pack (AP) Radial Led Specifications

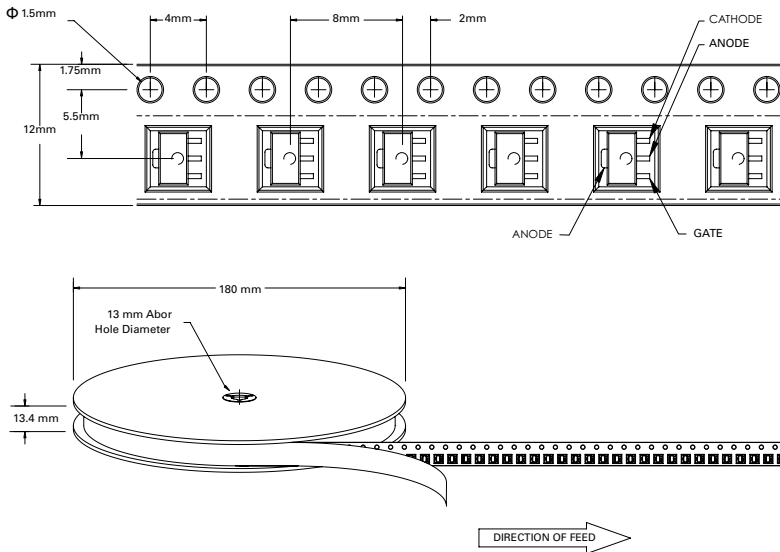
Meets all EIA-468-C Standards



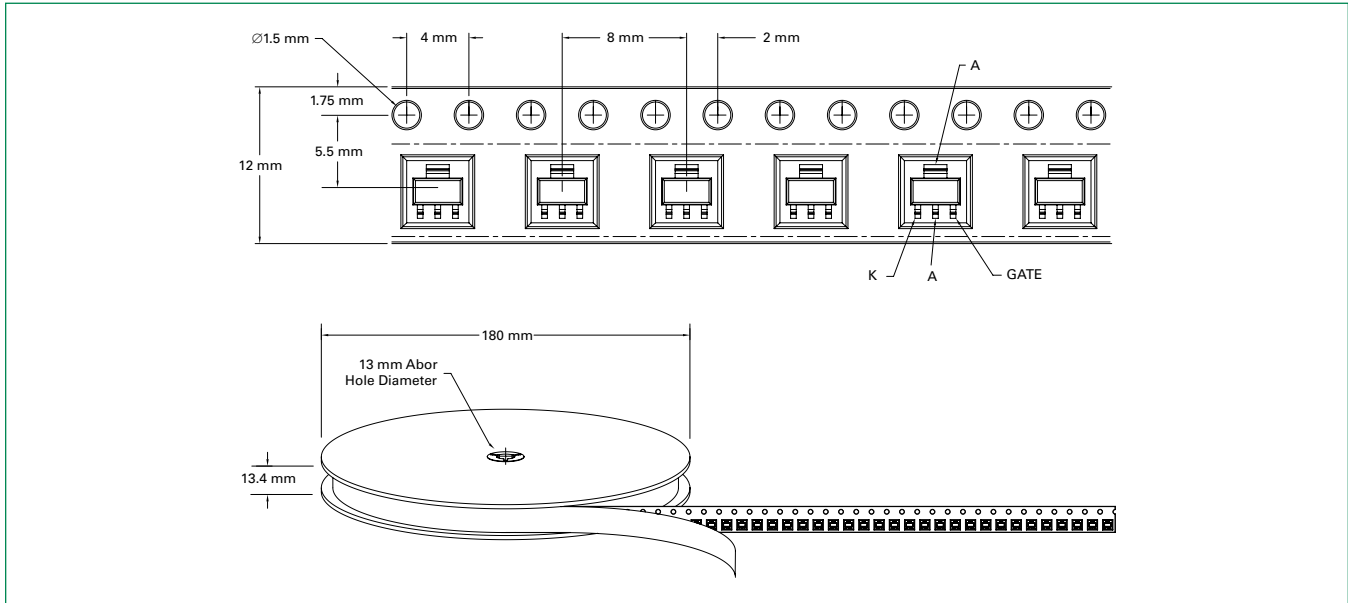
### SOT-89 Reel Pack (RP) Specifications



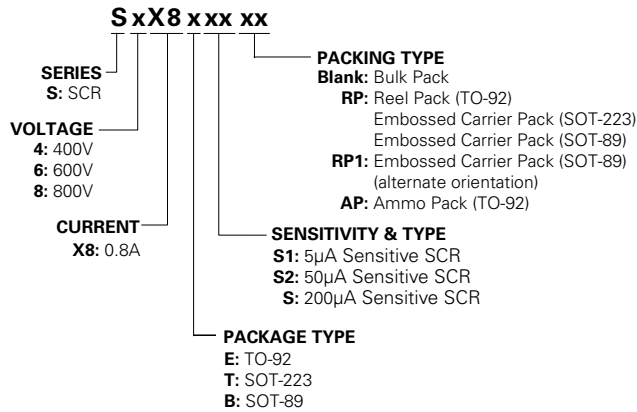
### SOT-89 Reel Pack (RP1) Specifications



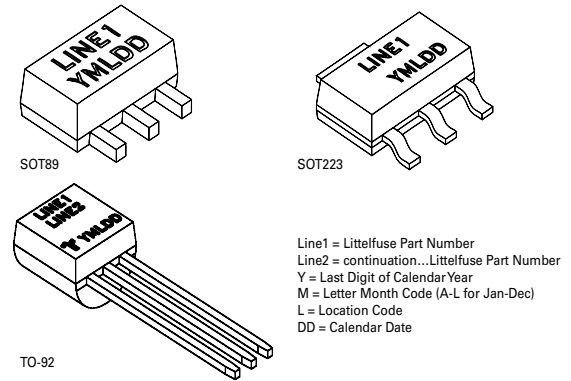
### SOT-223 Reel Pack (RP) Specifications



### Part Numbering System



### Part Marking System



## Looking for pricing, stock, or lifecycle information?

Click below to explore more details on WIN SOURCE:

 [View S8X8TSRP on WIN SOURCE](#)

 [Littelfuse Inc. Information](#)

## Optimize Your Supply Chain with WIN SOURCE Solutions

-  Global Sourcing Solution
-  Obsolete Management
-  Cost Control Management
-  Shortage Management
-  Alternative Solution
-  Excess Inventory Management