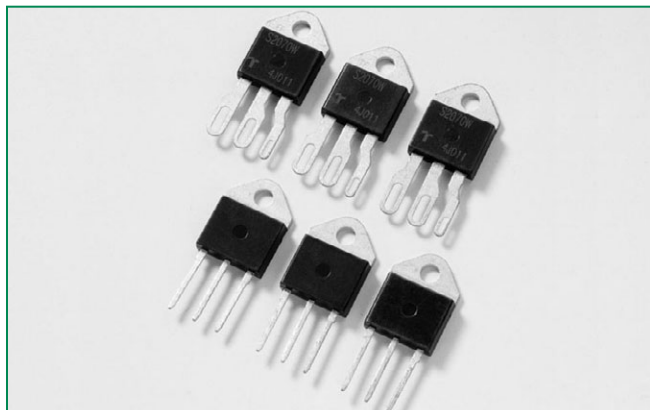




**THE DATASHEET OF  
S6035KTP**



**RoHS Sxx35x Series**

**Description**

Excellent unidirectional switches for phase control applications such as heating and motor speed controls. Standard phase control SCRs are triggered with few milliamperes of current at less than 1.5V potential.

**Features & Benefits**

- RoHS compliant
- Glass – passivated junctions
- Voltage capability up to 1000 V
- Surge capability up to 500 A

**Applications**

Typical applications are AC solid-state switches, industrial power tools, exercise equipment, white goods and commercial appliances.

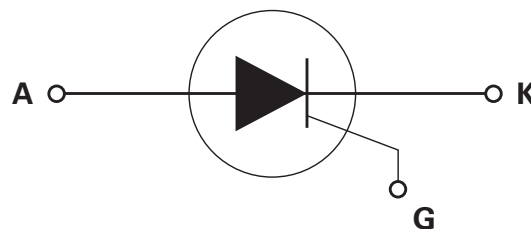
Internally constructed isolated packages are offered for ease of heat sinking with highest isolation voltage.

**Agency Approval**

Agency	Agency File Number
	J & K Packages: E71639

**Main Features**

Symbol	Value	Unit
$I_{T(RMS)}$	35	A
$V_{DRM}/V_{RRM}$	400 to 1000	V
$I_{GT}$	40	mA

**Schematic Symbol**

**Absolute Maximum Ratings**

Symbol	Parameter	Test Conditions	Value	Unit
$I_{T(RMS)}$	RMS on-state current	$T_c = 95^\circ\text{C}$	35	A
$I_{T(AV)}$	Average on-state current	$T_c = 95^\circ\text{C}$	22.0	A
$I_{TSM}$	Peak non-repetitive surge current	single half cycle; $f = 50\text{Hz}$ ; $T_j$ (initial) = $25^\circ\text{C}$	425	A
		single half cycle; $f = 60\text{Hz}$ ; $T_j$ (initial) = $25^\circ\text{C}$	500	
$I^2t$	$I^2t$ Value for fusing	$t_p = 8.3 \text{ ms}$	1035	$\text{A}^2\text{s}$
$di/dt$	Critical rate of rise of on-state current	$f = 60\text{Hz}$ ; $T_j = 125^\circ\text{C}$	150	$\text{A}/\mu\text{s}$
$I_{GM}$	Peak gate current	$T_j = 125^\circ\text{C}$	3.5	A
$P_{G(AV)}$	Average gate power dissipation	$T_j = 125^\circ\text{C}$	0.8	W
$T_{stg}$	Storage temperature range		-40 to 150	$^\circ\text{C}$
$T_j$	Operating junction temperature range		-40 to 125	$^\circ\text{C}$

**35 A SCRs**

**Electrical Characteristics (T<sub>J</sub> = 25°C, unless otherwise specified)**

Symbol	Test Conditions		Value	Unit	
I <sub>GT</sub>	V <sub>D</sub> = 12V; R <sub>L</sub> = 30Ω		MAX.	40	mA
			MIN.	5	
V <sub>GT</sub>			MAX.	1.5	V
dv/dt	V <sub>D</sub> = V <sub>DRM</sub> ; gate open; T <sub>J</sub> = 100°C	400V	MIN.	450	V/μs
		600V		425	
		800V		400	
	1000V	200			
	V <sub>D</sub> = V <sub>DRM</sub> ; gate open; T <sub>J</sub> = 125°C	400V		350	
		600V		325	
800V		300			
V <sub>GD</sub>	V <sub>D</sub> = V <sub>DRM</sub> ; R <sub>L</sub> = 3.3 kΩ; T <sub>J</sub> = 125°C		MIN.	0.2	V
I <sub>H</sub>	I <sub>T</sub> = 400mA (initial)		MAX.	50	mA
t <sub>g</sub>	(1)		MAX.	35	μs
t <sub>gt</sub>	I <sub>G</sub> = 2 x I <sub>GT</sub> ; PW = 15μs; I <sub>T</sub> = 70A		TYP.	2	μs

Notes :  
(1) I<sub>T</sub>=2A; t<sub>p</sub>=50μs; dv/dt=5V/μs; di/dt=30A/μs

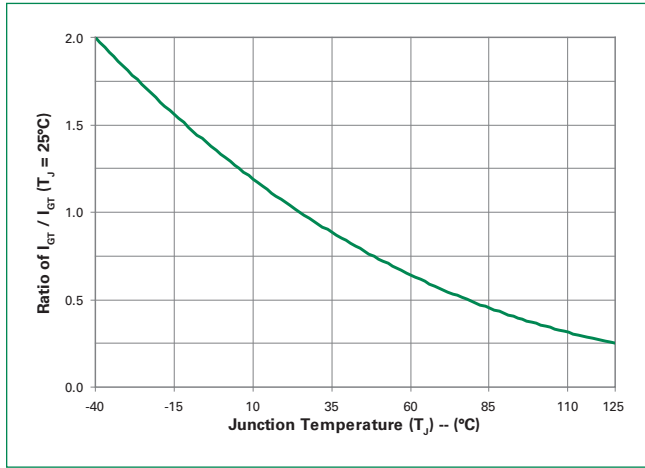
**Static Characteristics**

Symbol	Test Conditions		Value	Unit		
V <sub>TM</sub>	I <sub>T</sub> = 70A; t <sub>p</sub> = 380μs		MAX.	1.8	V	
I <sub>DRM</sub> / I <sub>RRM</sub>	V <sub>DRM</sub> / V <sub>RRM</sub>	T <sub>J</sub> = 25°C	400 – 600V	MAX.	10	μA
			800 – 1000V		20	
		T <sub>J</sub> = 100°C	400 – 600V		1000	
			800V		1500	
			1000V		3000	
		T <sub>J</sub> = 125°C	400 – 600V		2000	
			800V		3000	

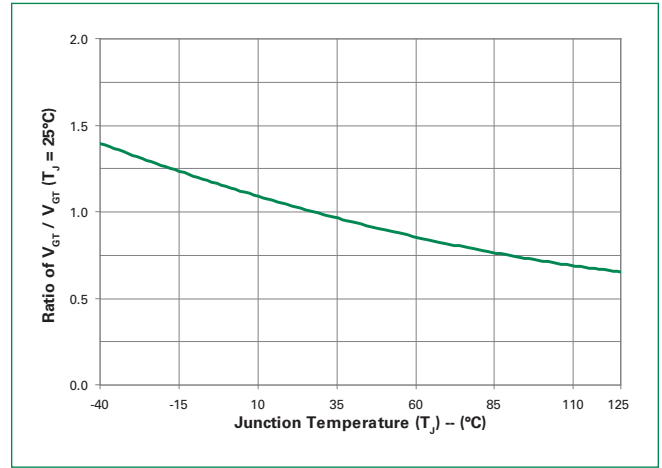
**Thermal Resistance**

Symbol	Parameter	Value	Unit
R <sub>θ(J-C)</sub>	Junction to case (AC)	0.7	°C/W

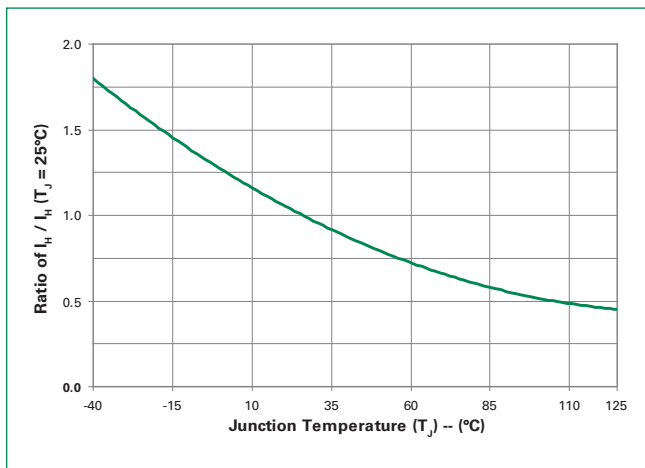
**Figure 1: Normalized DC Gate Trigger Current vs. Junction Temperature**



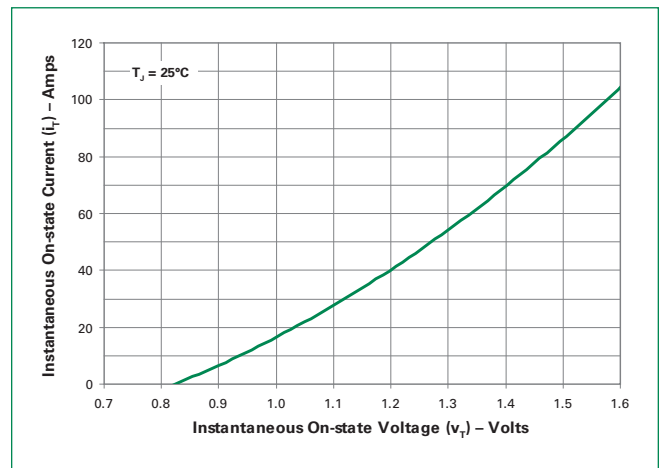
**Figure 2: Normalized DC Gate Trigger Voltage vs. Junction Temperature**



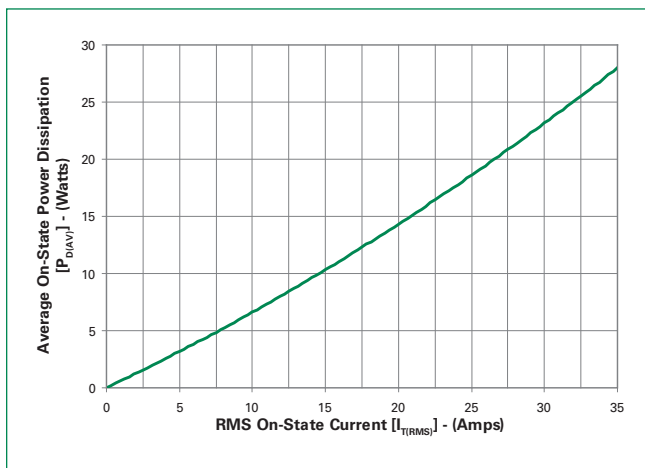
**Figure 3: Normalized DC Holding Current vs. Junction Temperature**



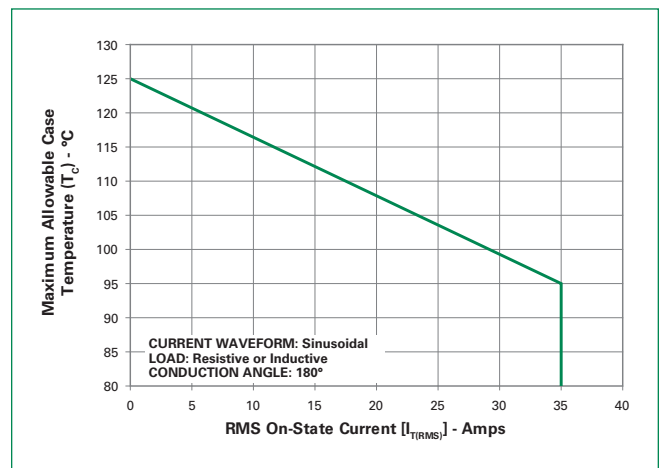
**Figure 4: On-State Current vs. On-State Voltage (Typical)**



**Figure 5: Power Dissipation (Typical) vs. RMS On-State Current**

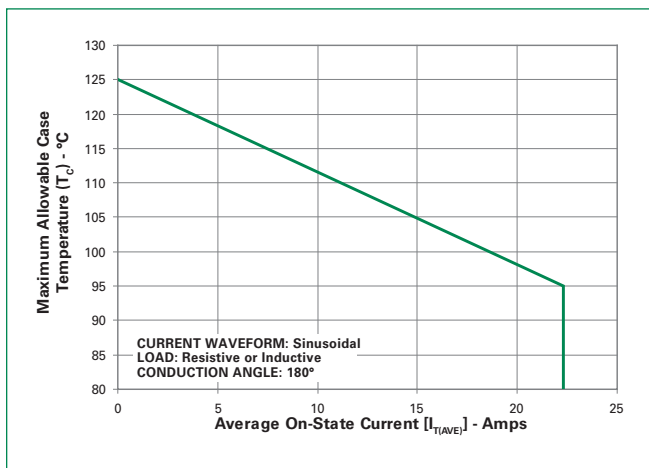


**Figure 6: Maximum Allowable Case Temperature vs. RMS On-State Current**

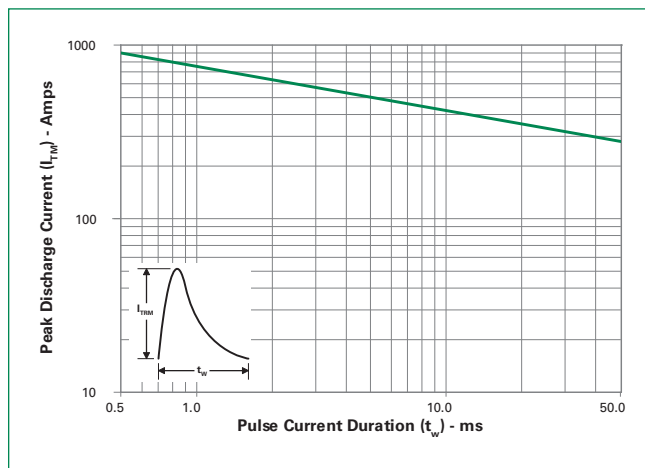


35 A SCRs

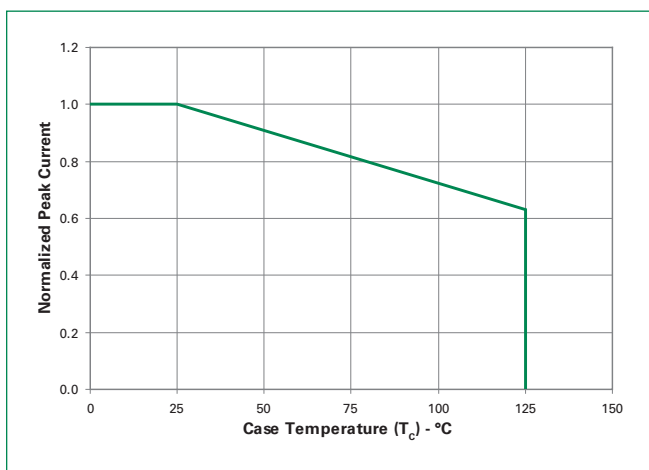
**Figure 7: Maximum Allowable Case Temperature vs. Average On-State Current**



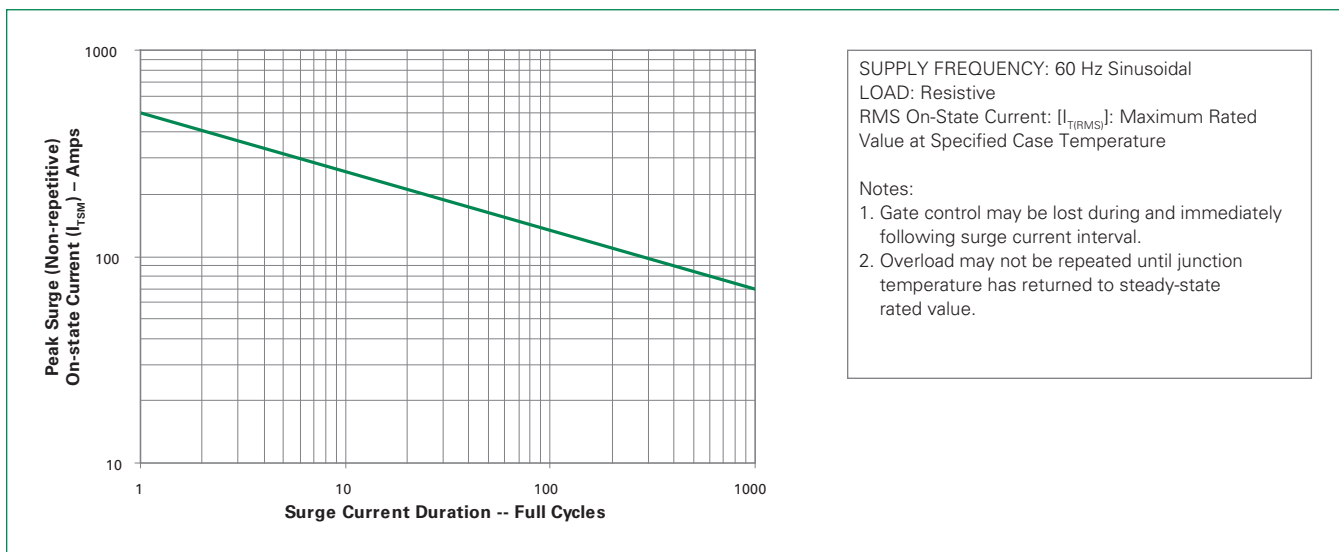
**Figure 8: Peak Capacitor Discharge Current**



**Figure 9: Peak Capacitor Discharge Current Derating**

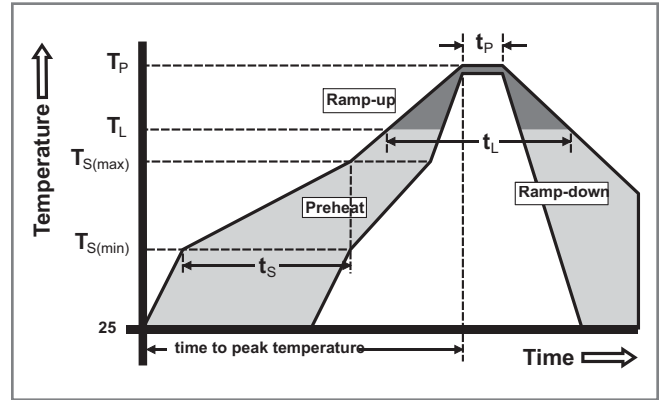


**Figure 10: Surge Peak On-State Current vs. Number of Cycles**



### Soldering Parameters

Reflow Condition		Pb – Free assembly
Pre Heat	- Temperature Min ( $T_{s(min)}$ )	150°C
	- Temperature Max ( $T_{s(max)}$ )	200°C
	- Time (min to max) ( $t_s$ )	60 – 180 secs
Average ramp up rate (Liquidus Temp ( $T_L$ ) to peak)		5°C/second max
$T_{s(max)}$ to $T_L$ - Ramp-up Rate		5°C/second max
Reflow	- Temperature ( $T_L$ ) (Liquidus)	217°C
	- Temperature ( $t_L$ )	60 – 150 seconds
Peak Temperature ( $T_p$ )		260 <sup>+0/-5</sup> °C
Time within 5°C of actual peak Temperature ( $t_p$ )		20 – 40 seconds
Ramp-down Rate		5°C/second max
Time 25°C to peak Temperature ( $T_p$ )		8 minutes Max.
Do not exceed		280°C



### Physical Specifications

<b>Terminal Finish</b>	100% Matte Tin-plated
<b>Body Material</b>	UL recognized epoxy meeting flammability classification 94V-0
<b>Lead Material</b>	Copper Alloy

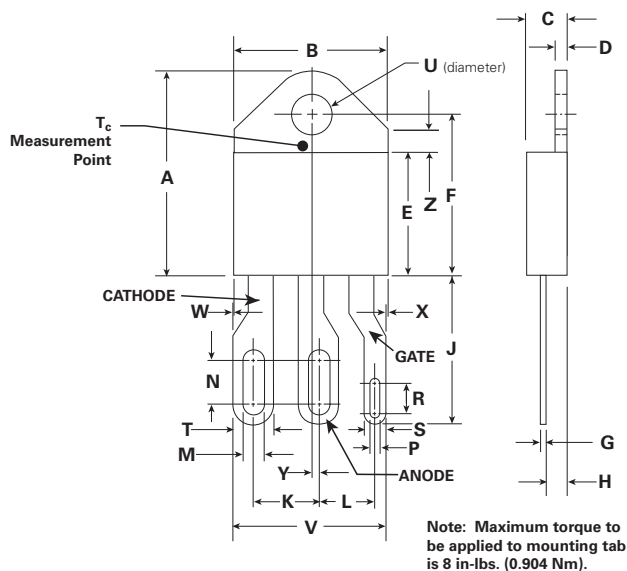
### Design Considerations

Careful selection of the correct device for the application's operating parameters and environment will go a long way toward extending the operating life of the Thyristor. Good design practice should limit the maximum continuous current through the main terminals to 75% of the device rating. Other ways to ensure long life for a power discrete semiconductor are proper heat sinking and selection of voltage ratings for worst case conditions. Overheating, overvoltage (including dv/dt), and surge currents are the main killers of semiconductors. Correct mounting, soldering, and forming of the leads also help protect against component damage.

### Environmental Specifications

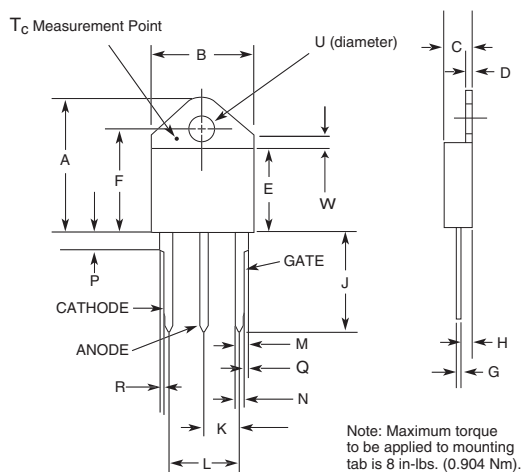
Test	Specifications and Conditions
<b>AC Blocking</b>	MIL-STD-750, M-1040, Cond A Applied Peak AC voltage @ 125°C for 1008 hours
<b>Temperature Cycling</b>	MIL-STD-750, M-1051, 100 cycles; -40°C to +150°C; 15-min dwell-time
<b>Temperature/Humidity</b>	EIA / JEDEC, JESD22-A101 1008 hours; 320V - DC: 85°C; 85% rel humidity
<b>High Temp Storage</b>	MIL-STD-750, M-1031, 1008 hours; 150°C
<b>Low-Temp Storage</b>	1008 hours; -40°C
<b>Thermal Shock</b>	MIL-STD-750, M-1056 10 cycles; 0°C to 100°C; 5-min dwelltime at each temperature; 10 sec (max) transfer time between temperature
<b>Autoclave</b>	EIA / JEDEC, JESD22-A102 168 hours (121°C at 2 ATMs) and 100% R/H
<b>Resistance to Solder Heat</b>	MIL-STD-750 Method 2031
<b>Solderability</b>	ANSI/J-STD-002, category 3, Test A
<b>Lead Bend</b>	MIL-STD-750, M-2036 Cond E

**Dimensions –TO- 218X (J Package) – Isolated Mounting Tab**



Dimension	Inches		Millimeters	
	Min	Max	Min	Max
A	0.810	0.835	20.57	21.21
B	0.610	0.630	15.49	16.00
C	0.178	0.188	4.52	4.78
D	0.055	0.070	1.40	1.78
E	0.487	0.497	12.37	12.62
F	0.635	0.655	16.13	16.64
G	0.022	0.029	0.56	0.74
H	0.075	0.095	1.91	2.41
J	0.575	0.625	14.61	15.88
K	0.256	0.264	6.50	6.71
L	0.220	0.228	5.58	5.79
M	0.080	0.088	2.03	2.24
N	0.169	0.177	4.29	4.49
P	0.034	0.042	0.86	1.07
R	0.113	0.121	2.87	3.07
S	0.086	0.096	2.18	2.44
T	0.156	0.166	3.96	4.22
U	0.164	0.165	4.10	4.20
V	0.603	0.618	15.31	15.70
W	0.000	0.005	0.00	0.13
X	0.003	0.012	0.07	0.30
Y	0.028	0.032	0.71	0.81
Z	0.085	0.095	2.17	2.42

**Dimensions –TO- 218AC (K Package) – Isolated Mounting Tab**



Dimension	Inches		Millimeters	
	Min	Max	Min	Max
A	0.810	0.835	20.57	21.21
B	0.610	0.630	15.49	16.00
C	0.178	0.188	4.52	4.78
D	0.055	0.070	1.40	1.78
E	0.487	0.497	12.37	12.62
F	0.635	0.655	16.13	16.64
G	0.022	0.029	0.56	0.74
H	0.075	0.095	1.91	2.41
J	0.575	0.625	14.61	15.88
K	0.211	0.219	5.36	5.56
L	0.422	0.437	10.72	11.10
M	0.058	0.068	1.47	1.73
N	0.045	0.055	1.14	1.40
P	0.095	0.115	2.41	2.92
Q	0.008	0.016	0.20	0.41
R	0.008	0.016	0.20	0.41
U	0.164	0.165	4.10	4.20
W	0.085	0.095	2.17	2.42

**Product Selector**

Part Number	Voltage				Gate Sensitivity	Type	Package
	400V	600V	800V	1000V			
Sxx35K	X	X	X	X	40mA	Standard SCR	TO-218AC
Sxx35J	X	X	X		40mA	Standard SCR	TO-218X

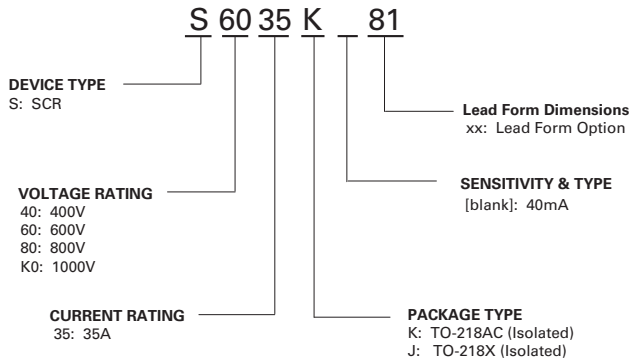
Note: xx = Voltage

**Packing Options**

Part Number	Marking	Weight	Packing Mode	Base Quantity
Sxx35KTP	Sxx35K	4.40g	Tube	250 (25 per tube)
Sxx35JTP	Sxx35J	5.23g	Tube	250 (25 per tube)

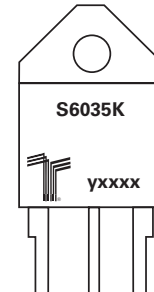
Note: xx = Voltage

**Part Numbering System**



**Part Marking System**

TO-218 AC (K Package)  
TO-218 X – (J Package)



## Looking for pricing, stock, or lifecycle information?

Click below to explore more details on WIN SOURCE:

 [View S6035KTP on WIN SOURCE](#)

 [Littelfuse Inc. Information](#)

## Optimize Your Supply Chain with WIN SOURCE Solutions

-  Global Sourcing Solution
-  Obsolete Management
-  Cost Control Management
-  Shortage Management
-  Alternative Solution
-  Excess Inventory Management