



THE DATASHEET OF
S558-5500-02-F



VOICE OVER IP MAGNETICS

Broadband Transformers

LM00200

- Support 10 Mbps and 100 Mbps VoIP applications
- Compliant with IEEE 802.3 standards
- Designed to meet 350mA balanced DC line current
- 350µH OCL with 8mA bias applied from 0° to 70° C
- Minimum interwinding breakdown voltage of 1500 Vrms

ELECTRICAL SPECIFICATIONS AT 25° C

Part Number	Turns Ratio ±3%		Primary Inductance µH min	Leakage Inductance µH max	Interwinding Capacitance pF max	DCR Ω max			
	TXIN : TXO	RXIN : RXO				TXIN	TXO	RXIN	RXO
S558-5500-02	1CT : 1CT	1CT : 1CT	350	0.25	25	1.0	1.0	1.0	1.0
S558-5500-04	1CT : 1CT	1CT : 1CT	350	0.25	25	1.0	1.0	1.0	1.0
S558-5500-12	1CT : 1CT	1CT : 1CT	350	0.25	25	1.0	1.0	1.0	1.0
S558-5500-16	1CT : 1CT	1CT : 1CT	350	0.25	40	1.0	1.4	1.0	1.4

Part Number	Insertion Loss dB min	Return Loss dB min			Crosstalk dB min				Common to Differential Mode Rejection dB min	Common to Common Mode Rejection dB min
		100kHz to 100MHz	2MHz to 30MHz	60MHz to 80MHz	1MHz	30MHz	60MHz	100MHz		
S558-5500-02	-1.5	-16	-10	-65	-60	-50	-45	-45	-45	
S558-5500-04	-1.5	-16	-10	-65	-60	-50	-45	-45	-45	
S558-5500-12	-1.5	-16	-10	-65	-60	-50	-45	-45	-45	
S558-5500-16	-1.5	-16	-10	-65	-60	-50	-45	-45	-45	

VOICE OVER IP MAGNETICS Broadband Transformers

SCHEMATIC

S558-5500-02
S558-5500-04

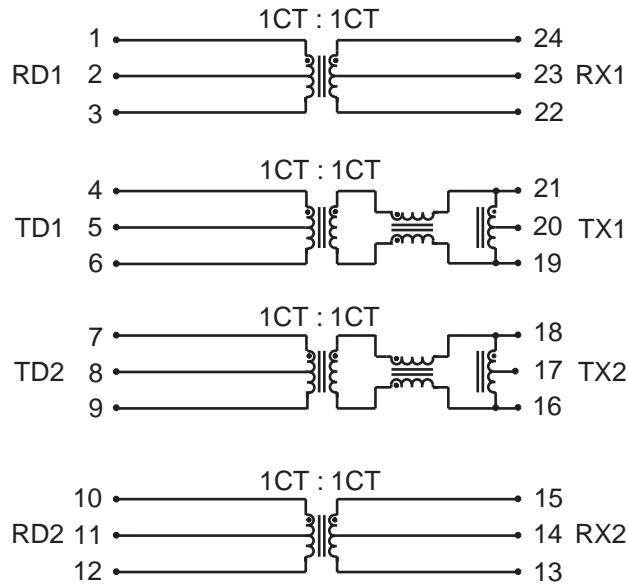

S558-5500-12

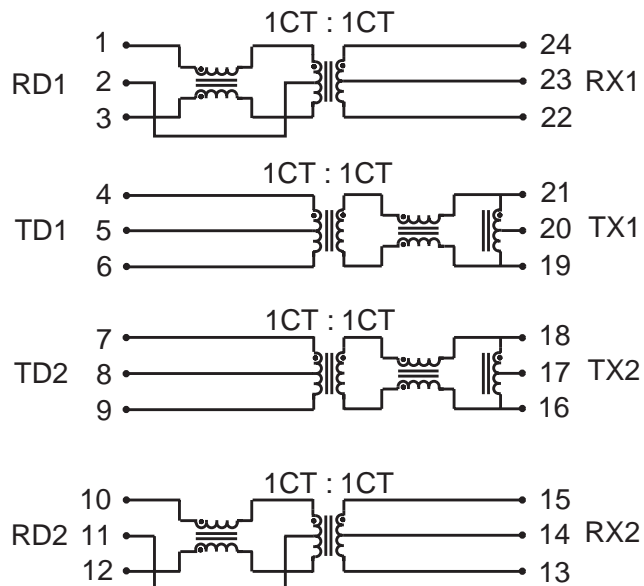

VOICE OVER IP MAGNETICS

Broadband Transformers

LM00200

SCHEMATIC

S558-5500-16

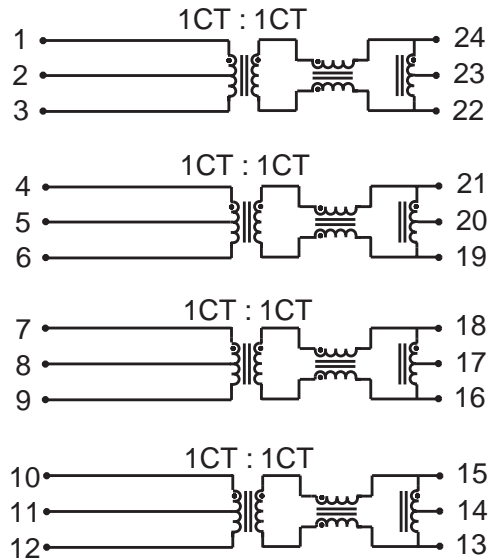

MECHANICAL

S558-5500-02

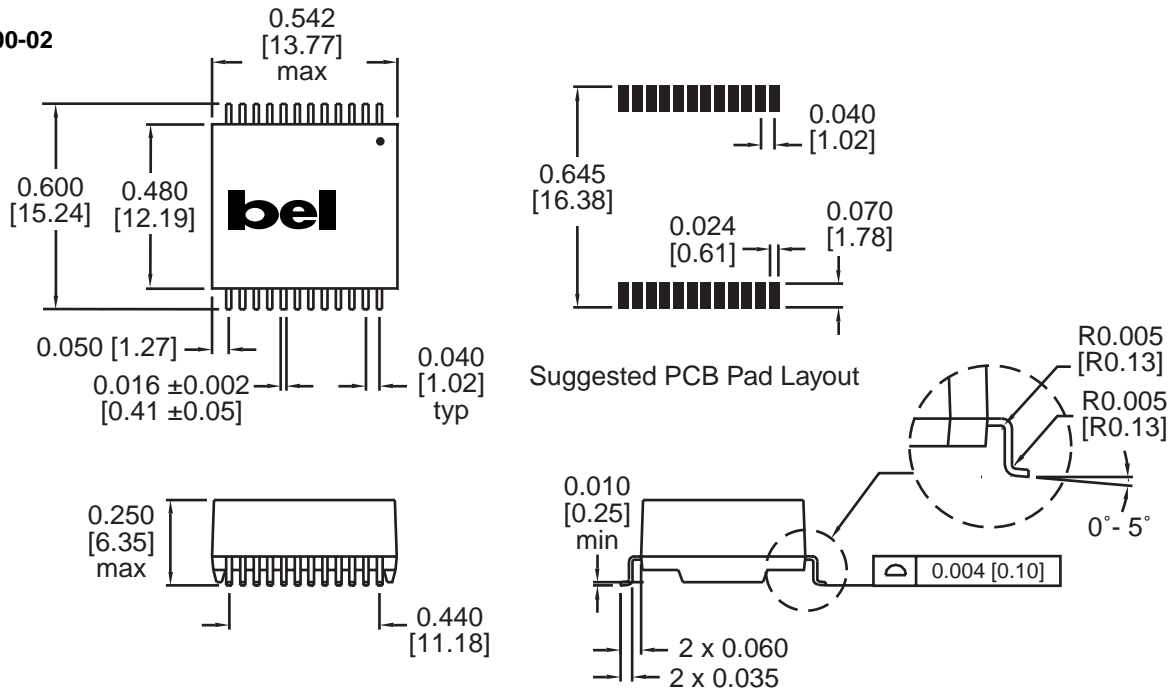

Dimensions are in inches [millimeters].
Standard dimension tolerance is ± 0.005 [0.13] unless otherwise noted.

LM00200

MECHANICAL

S558-5500-04
S558-5500-12
S558-5500-16

Suggested PCB Pad Layout

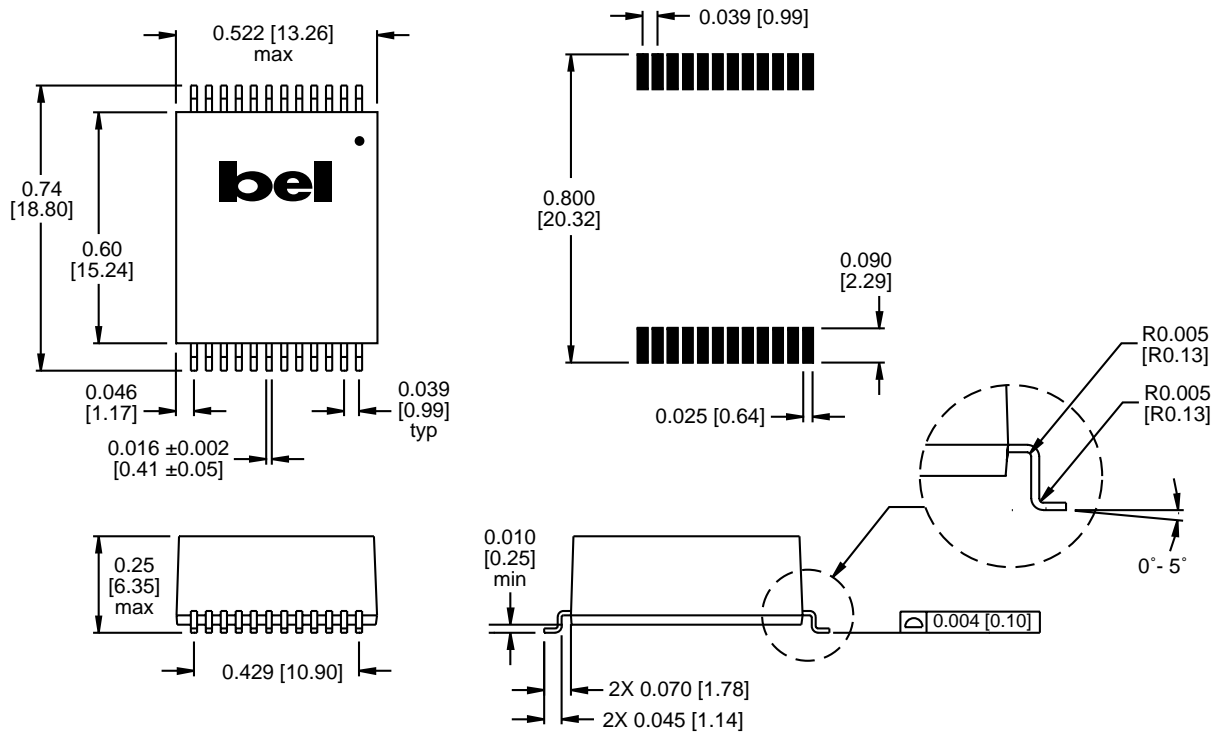

Dimensions are in inches [millimeters].
Standard dimension tolerance is ± 0.005 [0.13] unless otherwise noted.

©2004 Bel Fuse Inc. Specifications subject to change without notice. 01.04

CORPORATE

Bel Fuse Inc.
206 Van Vorst Street
Jersey City, NJ 07302
Tel 201-432-0463
Fax 201-432-9542
www.belfuse.com

FAR EAST

Bel Fuse Ltd.
8F / 8 Luk Hop Street
San Po Kong
Kowloon, Hong Kong
Tel 852-2328-5515
Fax 852-2352-3706
www.belfuse.com

EUROPE

Bel Fuse Europe Ltd.
Preston Technology Management Centre
Marsh Lane, Suite G7, Preston
Lancashire, PR1 8UD, U.K.
Tel 44-1772-556601
Fax 44-1772-888366
www.belfuse.com

Looking for pricing, stock, or lifecycle information?

Click below to explore more details on WIN SOURCE:

 [View S558-5500-02-F on WIN SOURCE](#)

 [Bel Fuse Inc. Information](#)

Optimize Your Supply Chain with WIN SOURCE Solutions

-  Global Sourcing Solution
-  Obsolete Management
-  Cost Control Management
-  Shortage Management
-  Alternative Solution
-  Excess Inventory Management