

REAL TIME CLOCK MODULE (I²C-Bus)

RX-8581 SA/ JE/ NB

- Built-in frequency adjusted 32.768 kHz crystal unit.
- Interface Type : I²C-Bus Interface (400 kHz)
- Operating voltage range : 1.8 V to 5.5 V
- Wide Timekeeper voltage range : 1.6 V to 5.5 V
- Low backup current : 0.45 μA / 3 V (Typ.)
- 32.768 kHz frequency output function : C-MOS output With Control Pin
- The various functions include full calendar, alarm, timer.

* The I²C-Bus is a trademark of NXP Semiconductors



Product Number (Please contact us)
 RX-8581SA : Q41858152000200
 RX-8581JE : Q41858171000200
 RX-8581NB : Q41858192000200



Actual size



Block diagram

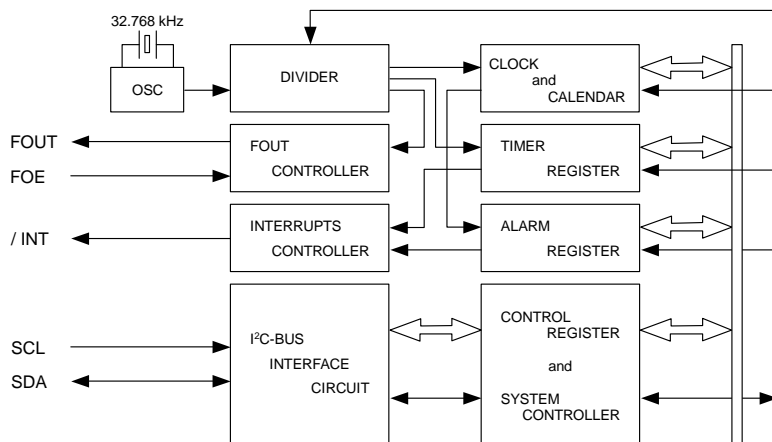

Overview

- **Interface Type**
 - I²C-Bus interface. (Hi-speed bus specifications 400 kHz)
 - * I²C-Bus slave address : read A3h and write A2h
- **32.768 kHz frequency output function**
 - FOUT pin output (C-MOS output), CL=30 pF
 - 32.768 kHz clock frequency output. (Duty 50 ±5 %)
- **Timer function**
 - Timer interrupt function can be set up between 1/4096 second and 4095 minutes.
 - It is recorded automatic to TF-bit at the time of event occurrence, and possible to output with /TIRQ pin output (N-ch open-drain output).
- **Interrupt function**
 - Alarm interrupt function, Time update interrupt function.

Terminal connection / External dimensions

(Unit:mm)

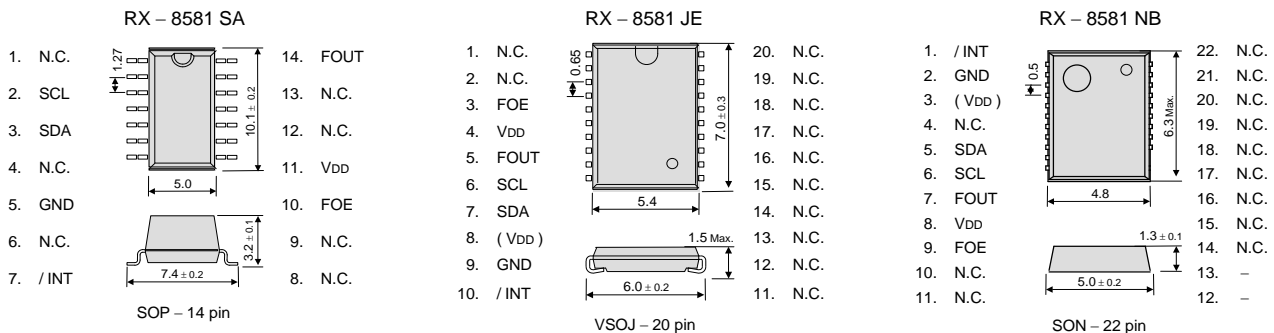

The metal case inside of the molding compound may be exposed on the top or bottom of this product. This purely cosmetic and does not have any effect on quality, reliability or electrical specs.

Specifications (characteristics)

* Refer to application manual for details.

Recommended Operating Conditions

Item	Symbol	Conditions	Min.	Typ.	Max.	Unit
Power voltage	V _{DD}	—	1.8	3.0	5.5	V
Clock voltage	V _{CLK}	—	1.6	3.0	5.5	V
Operating temperature	T _{OPR}	—	-40	+25	+85	°C

Frequency characteristics

Item	Symbol	Conditions	Rating	Unit
Frequency tolerance	Δ f / f	T _a = +25 °C V _{DD} = 3.0 V	B: 5 ± 23 *	× 10 ⁻⁶
FOUT output Duty	tw / t	T _a = -40 °C to +85 °C V _{DD} = 2.4 V to 5.5 V	50 ± 5	%

* Please ask for tighter tolerance. (Equivalent to ±1 minute of monthly deviation)

Current consumption characteristics

T_a = -40 °C to +85 °C

Item	Symbol	Conditions	Min.	Typ.	Max.	Unit	
Current Consumption	I _{BK}	f _{SCL} = 0 Hz FOE = GND	V _{DD} = 5 V	-	0.65	1.2	μA
		FOUT ; output OFF (LOW)	V _{DD} = 3 V	-	0.45	0.8	
	I _{32k}	f _{SCL} = 0 Hz FOE = V _{DD}	V _{DD} = 5 V	-	8.0	20.0	μA
		FOUT ; 32.768 kHz output ON CL = 30 pF	V _{DD} = 3 V	-	5.0	12.0	

PROMOTION OF ENVIRONMENTAL MANAGEMENT SYSTEM CONFORMING TO INTERNATIONAL STANDARDS

At Seiko Epson, all environmental initiatives operate under the Plan-Do-Check-Action (PDCA) cycle designed to achieve continuous improvements. The environmental management system (EMS) operates under the ISO 14001 environmental management standard.

All of our major manufacturing and non-manufacturing sites, in Japan and overseas, completed the acquisition of ISO 14001 certification.

ISO 14000 is an international standard for environmental management that was established by the International Standards Organization in 1996 against the background of growing concern regarding global warming, destruction of the ozone layer, and global deforestation.





WORKING FOR HIGH QUALITY

In order provide high quality and reliable products and services than meet customer needs,

Seiko Epson made early efforts towards obtaining ISO9000 series certification and has acquired ISO9001 for all business establishments in Japan and abroad. We have also acquired ISO/TS 16949 certification that is requested strongly by major automotive manufacturers as standard.

ISO/TS16949 is the international standard that added the sector-specific supplemental requirements for automotive industry based on ISO9001.

► Explanation of the mark that are using it for the catalog



	► Pb free.
	► Complies with EU RoHS directive. *About the products without the Pb-free mark. Contains Pb in products exempted by EU RoHS directive. (Contains Pb in sealing glass, high melting temperature type solder or other.)
	► Designed for automotive applications such as Car Multimedia, Body Electronics, Remote Keyless Entry etc.
	► Designed for automotive applications related to driving safety (Engine Control Unit, Air Bag, ESC etc).

Notice

- This material is subject to change without notice.
- Any part of this material may not be reproduced or duplicated in any form or any means without the written permission of Seiko Epson.
- The information about applied data, circuitry, software, usage, etc. written in this material is intended for reference only. Seiko Epson does not assume any liability for the occurrence of customer damage or infringing on any patent or copyright of a third party. This material does not authorize the licensing for any patent or intellectual copyrights.
- When exporting the products or technology described in this material, you should comply with the applicable export control laws and regulations and follow the procedures required by such laws and regulations.
- You are requested not to use the products (and any technical information furnished, if any) for the development and/or manufacture of weapon of mass destruction or for other military purposes. You are also requested that you would not make the products available to any third party who may use the products for such prohibited purposes.
- These products are intended for general use in electronic equipment. When using them in specific applications that require extremely high reliability, such as the applications stated below, you must obtain permission from Seiko Epson in advance.
/ Space equipment (artificial satellites, rockets, etc.) / Transportation vehicles and related (automobiles, aircraft, trains, vessels, etc.) / Medical instruments to sustain life / Submarine transmitters / Power stations and related / Fire work equipment and security equipment / traffic control equipment / and others requiring equivalent reliability.
- All brands or product names mentioned herein are trademarks and/or registered trademarks of their respective.

Looking for pricing, stock, or lifecycle information?

Click below to explore more details on WIN SOURCE:

-  [View RX-8581NB:B3 on WIN SOURCE](#)
-  [Epson Company Information](#)

Optimize Your Supply Chain with WIN SOURCE Solutions

-  Global Sourcing Solution
-  Obsolete Management
-  Cost Control Management
-  Shortage Management
-  Alternative Solution
-  Excess Inventory Management