



THE DATASHEET OF RTAN-5006



6A to 60A, 500VAC EMI Filters

Features

- ◆ High Voltage Pulse Attenuation
- ◆ DIN Rail Mount Option (Up 30A)
- ◆ Conforms to UL and EN Safety Agency Certifications



Key Market Segments & Applications

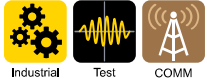

Specifications		RTAN-5006 RTAN-5006D	RTAN-5010 RTAN-5010D	RTAN-5020 RTAN-5020D	RTAN-5030 RTAN-5030D	RTAN-5040
Model						
Rated Voltage (AC, DC)	V	500V Three phase				
Rated Current	A	6A	10A	20A	30A	40A
DC Resistance (total)	mΩ	350	140	60	35	22
Model		RTAN-5050	RTAN-5060			
Rated Voltage (AC, DC)	V	500V Three phase				
Rated Current	A	50A	60A			
DC Resistance (total)	mΩ	7	5			
Withstand Voltage	V	Terminals to Case: 2500VAC (1 Minute)				
Isolation Resistance	MΩ	100MΩ minimum (500VDC, 1 Minute)				
Leakage Current (max)	A	2.5mA at 250VAC 60Hz, 5mA at 500VAC 60Hz				
Operating Temperature	°C	-25 to +85°C (Derate above 50°C, see derating curve)				
Storage Temperature	°C	-25 to +85°C				
Safety Agency Certifications	-	UL1283 & EN60939				
Weight	g	360g to 1120g model dependant (See weights chart on website)				
Warranty	yr	5 Year				

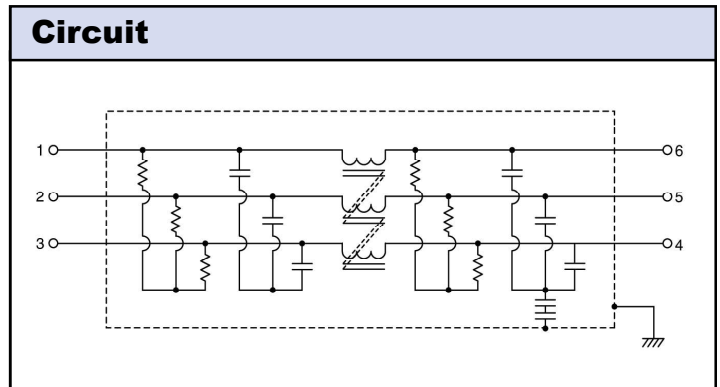
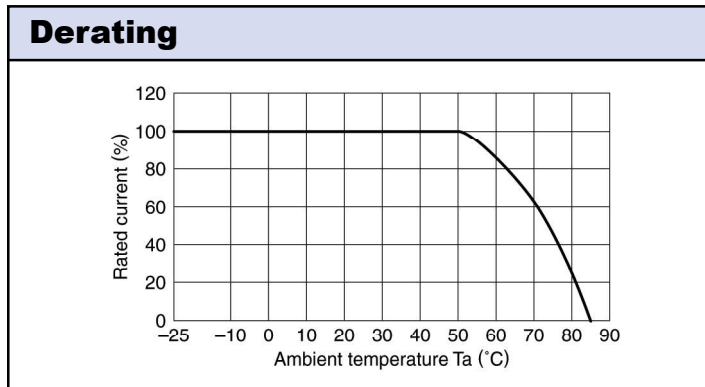

Options

Chassis Mount	RTAN-50xx
DIN Rail Mount (Models up to 30A)	RTAN-50xxD

Outline Drawing

RTAN-5006D/5010D

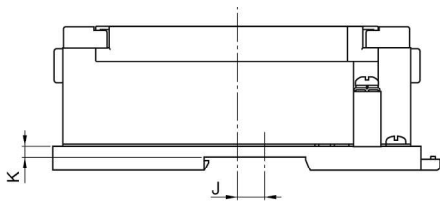
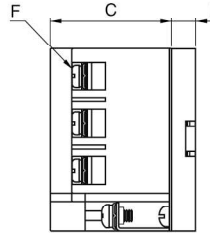
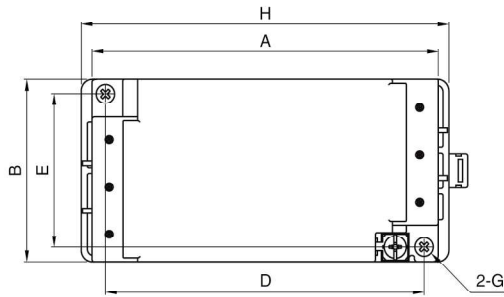

Dimensions in mm

Part No.	A	B	C	D	E	F	G	φH	Recommended clamping torque
RTAN-5006	120	63	42	110	53	M4	M4	4.5	M4 : 1.27N · m M5 : 2.5N · m
RTAN-5010	140	70	42	130	60	M4	M4	4.5	
RTAN-5020	140	70	42	130	60	M4	M4	4.5	
RTAN-5030	170	90	54	160	80	M5	M4	4.5	
RTAN-5040									
RTAN-5050									
RTAN-5060									

RTAN-5020D/5030D

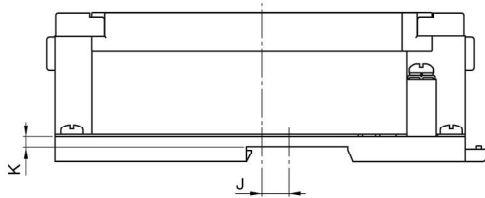
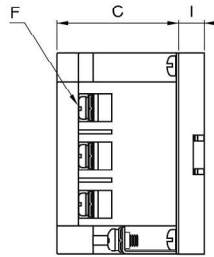
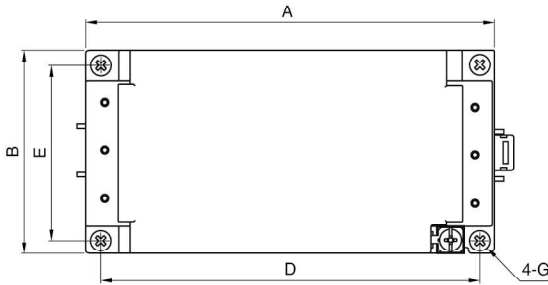

Dimensions in mm



Part No.	A	B	C	D	E	F	G	H	I	J	K
RTAN-5006D	120	63	42	110	53	M4	M4	127	8.4	6	3.5
RTAN-5010D	140	70	42	130	60			-	8.4	12.5	3.5
RTAN-5020D											
RTAN-5030D											

For Additional Information, please visit
us.tdk-lambda.com/lp/products/r-series.htm



Looking for pricing, stock, or lifecycle information?

Click below to explore more details on WIN SOURCE:

-  [View RTAN-5006 on WIN SOURCE](#)
-  [TDK-Lambda Americas Inc. Information](#)

Optimize Your Supply Chain with WIN SOURCE Solutions

-  Global Sourcing Solution
-  Obsolete Management
-  Cost Control Management
-  Shortage Management
-  Alternative Solution
-  Excess Inventory Management