



# THE DATASHEET OF EVB\_RT8086BGQUF



## 3.5A, 1.2MHz, Synchronous Step-Down Converter

### ***Purpose***

The RT8086B is a current mode COT step-down converter with the input voltage range from 2.8V to 5.5V and provides 3.5A outputcurrent. This document explains the function and use of the RT8086B evaluation board (EVB), and provides information to enable operation, modification of the evaluation board and circuit to suit individual requirements.

## Table of Contents

Purpose.....	1
Introduction.....	2
Key Performance Summary Table.....	2
Bench Test Setup Conditions.....	3
Schematic, Bill of Materials & Board Layout.....	5
More Information.....	8
Important Notice for Richtek Evaluation Board.....	8

## Introduction

### General Product Information

The RT8086B is a high efficiency, synchronous step-down DC/DC converter. The available input voltage range is from 2.8V to 5.5V and the regulated output voltage is adjustable from 0.6V to 3.3V while delivering up to 3.5A of output current. Product Feature. The internal synchronous low on-resistance power switches increase efficiency and eliminate the need for an external Schottky diode. The current mode constant on-time operation with internal compensation allows the transient response to be optimized over a wide range of loads and output capacitors. The RT8086B is available in the UQFN-12L 2x2 (FC) package.

### Product Features

- High Efficiency Up to 95%
- Low  $R_{DS(ON)}$  Switches : 50m $\Omega$ /40m $\Omega$
- 0.6V Reference Allows for Low Output Voltage
- Internal Compensation
- Input Voltage Range : 2.8V to 5.5V
- Adjustable Output Voltage from 0.6V to 3.3V
- 1.2MHz Switching Frequency
- Start-Up into Pre-Biased Load
- Built in Soft-Start
- Power Good Indication
- Cycle-by-Cycle Current Limit
- Input Under Voltage Lockout
- Output Under Voltage Protection (Hiccup)
- Thermal Shutdown Protection
- RoHS Compliant and Halogen Free

### Key Performance Summary Table

Key Features	Evaluation Board Number : PCB064_V1
Default Input Voltage	3.3V
Max Output Current	3.5A
Default Output Voltage	1.2V
Default Marking & Package Type	RT8086BGQUF, UQFN-12L 2x2 (FC)
Operation Frequency	1.2MHz Switching Frequency

## Bench Test Setup Conditions

### Headers Description and Placement

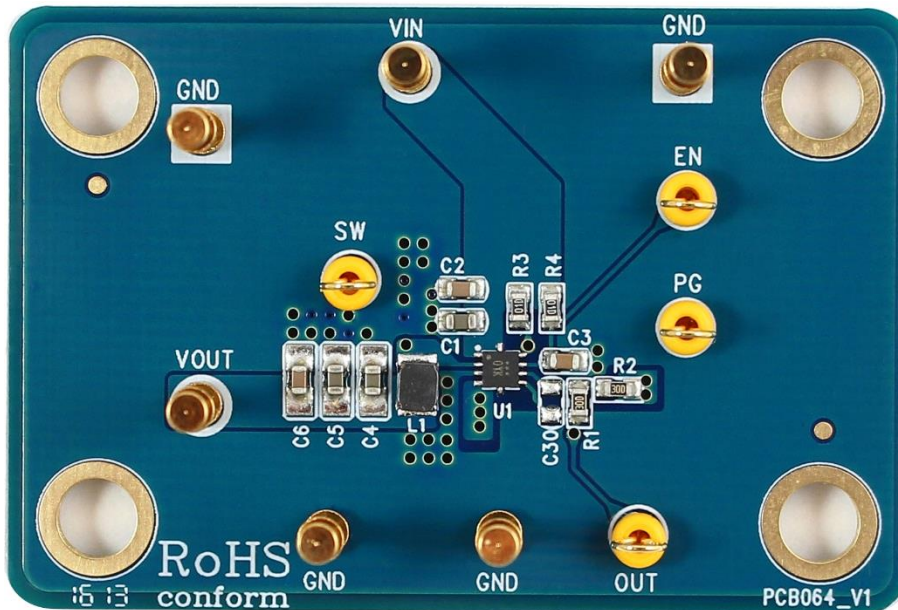

Please carefully inspect the EVB IC and external components, comparing them to the following Bill of Materials, to ensure that all components are installed and undamaged. If any components are missing or damaged during transportation, please contact the distributor or send e-mail to [evb\\_service@richtek.com](mailto:evb_service@richtek.com).

### Test Points

The EVB is provided with the test points and pin names listed in the table below.

Test point/ Pin name	Signal	Comment (expected waveforms or voltage levels on test points)
<b>PVIN</b>	Input voltage	Power Input. The available input voltage range is from 2.8V to 5.5V. A 10 $\mu$ F or larger input capacitor is needed to reduce voltage spikes at the input.
<b>PGND</b>	Ground	Power Ground.
<b>AGND</b>	Ground	Analog Ground.
<b>NC</b>	No Internal Connection	No Internal Connection.
<b>VOUT</b>	Output Voltage	Sense Input Pin for Output Voltage.
<b>FB</b>	Feedback Input Voltage	Feedback Input. This pin used to set the output voltage of the converter to regulate to the desired value via an external resistive divider. The feedback reference voltage is 0.6V typically.
<b>LX</b>	Switch Node test pin	Switch Node. Output of the internal high side and low side MOSFETs.
<b>EN</b>	Enable test point	Enable Control Input. A logic-high (1.2V < EN < 5.5V) enables the converter; a logic-low forces the IC into shutdown mode.
<b>PGOOD</b>	PGOOD test point	Power Good Indicator. The output of this pin is an open drain with internal pull-up resistor to VIN. The output of this pin is pulled to high when the FB voltage is within 10%; otherwise it is Low.
<b>VIN</b>	Input Voltage	Supply Voltage for Internal Control Circuit. It is connected to PVIN inside the chip.

### ***Power-up & Measurement Procedure***

1. Apply a 3.3V nominal input power supply (2.8V to 5.5V) to the VIN and GND terminals
2. Connect an external load up to 3.5A to the VOUT and GND terminals and verify the output voltage and current.

### ***Output Voltage Setting***

Set the output voltage with the resistive divider (R1, R2) between External Input and GND with the midpoint connected to VREFIN. The output is set by the following formula :

$$V_{REFIN} = \text{External Input} \cdot R2 / (R1 + R2)$$

### Schematic, Bill of Materials & Board Layout

#### EVB Schematic Diagram

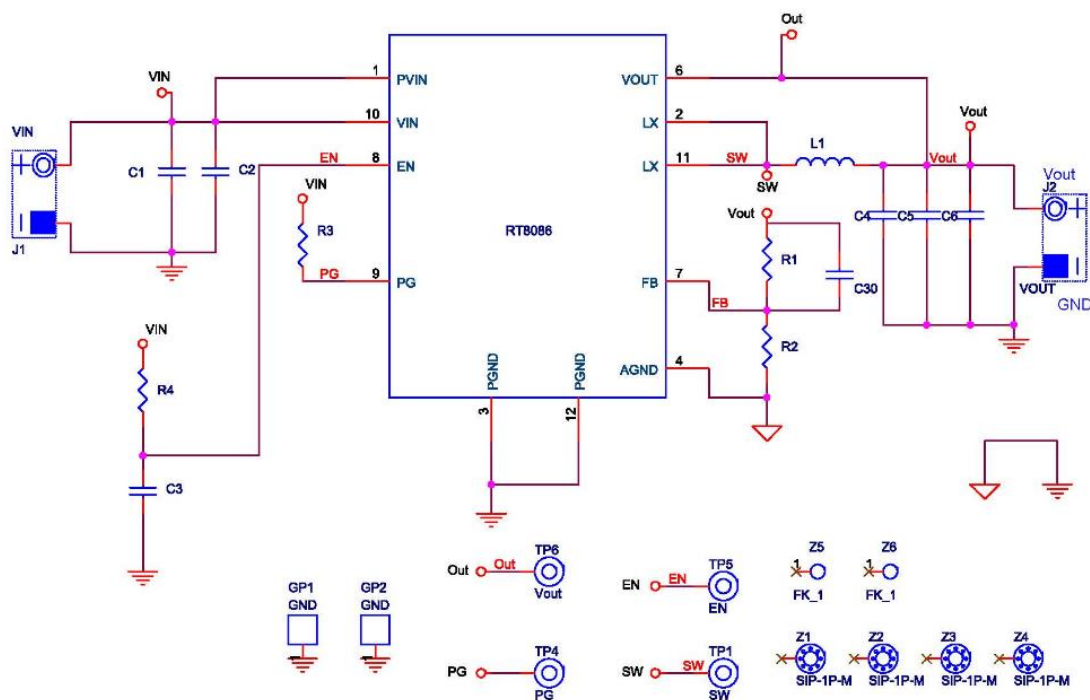

#### Bill of Materials

Reference	Qty	Part Number	Description	Package	Manufacture
C1	1	0603X106M6R3	10 $\mu$ F/X5R/6.3V/0603	C-0603	WALSIN
C2, C3	2	C1608X7R1H104KT000N	0.1 $\mu$ F/X7R/50V/0603	C-0603	TDK
C4, C5	2	0603X106M6R3	10 $\mu$ F/X5R/6.3V/0603	C-0603	WALSIN
C6	1	C1608X7R1H104KT000N	0.1 $\mu$ F/X7R/50V/0603	C-0603	TDK
C30	1		NC		
GP1, GP2	2		GND		
J1	1		VIN		
J2	1		VOUT		
L1	1	PIFE25201B-1R0M	1.0 $\mu$ H		Cyntec
R1, R2	2	0603 200K 1%	200k	R-0603	WALSIN
R3, R4	2	0603 100K 1%	100K	R-0603	WALSIN
TP1	1		SW		
TP4	1		PG		
TP5	1		EN		
TP6	1		VOUT		
U1	1	RT8086BGQUF	DC/DC Converter	UQFN-12L 2x2 (FC)	RICHTEK
Z1, Z2, Z3, Z4	4		SIP-1P-M		
Z5, Z6	2		FK_1		

**PCB Layout**

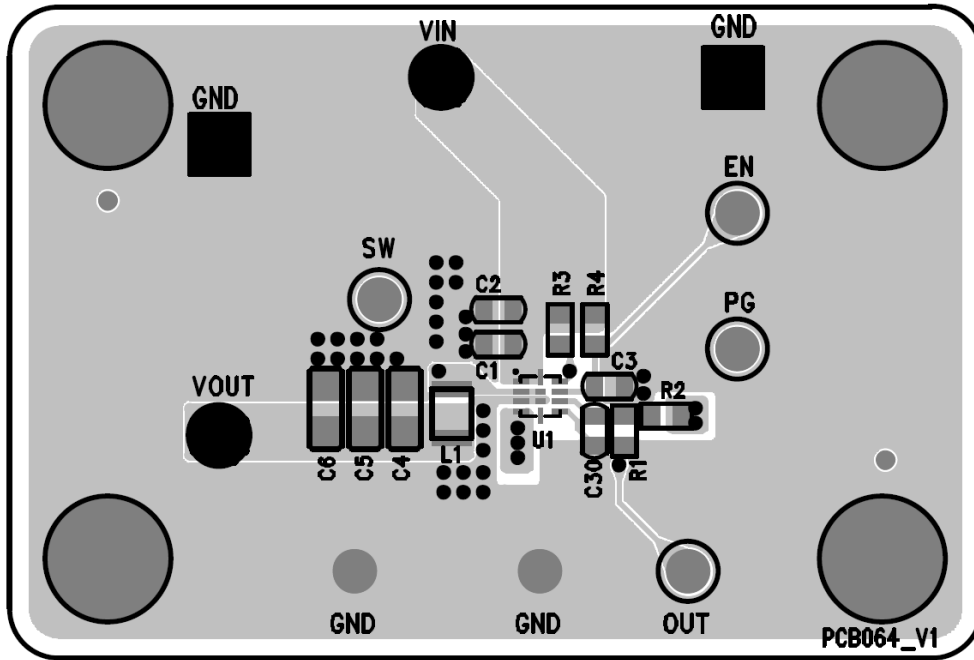

Top View (1<sup>st</sup> layer)

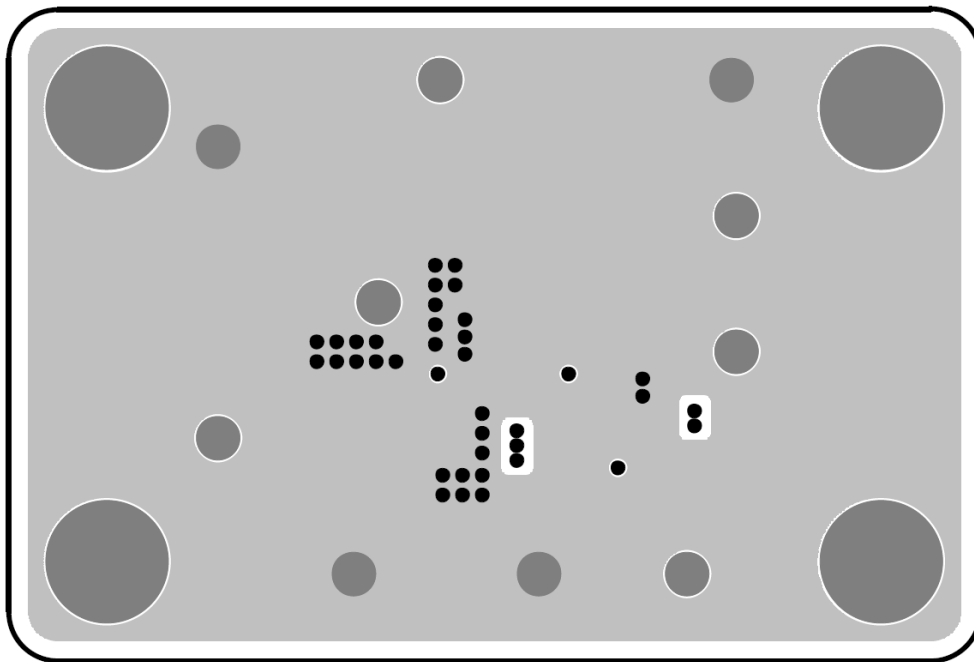

PCB Layout—Inner Side (2<sup>nd</sup> Layer)

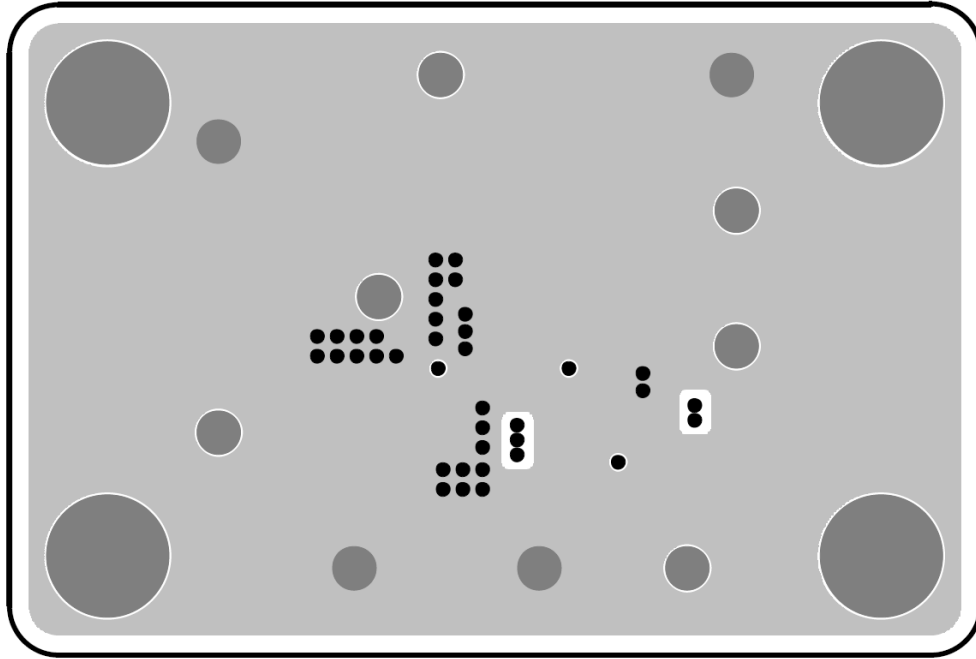

PCB Layout—Inner Side (3<sup>rd</sup> Layer)

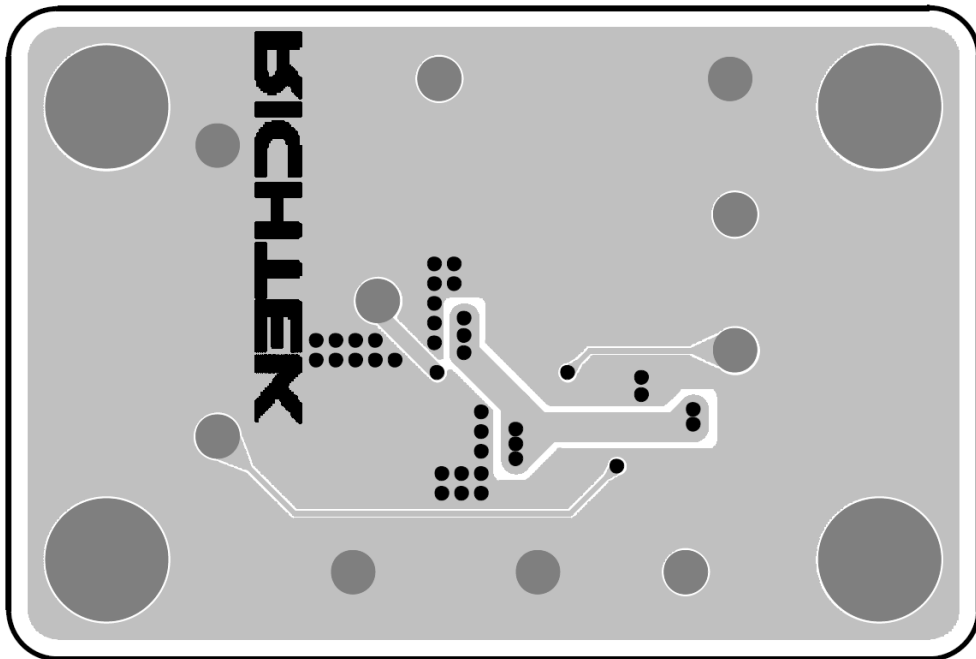

Bottom View (4<sup>th</sup> Layer)

### ***More Information***



For more information, please find the related datasheet or application notes from Richtek website <http://www.richtek.com>.

### ***Important Notice for Richtek Evaluation Board***







THIS DOCUMENT IS FOR REFERENCE ONLY, NOTHING CONTAINED IN THIS DOCUMENT SHALL BE CONSTRUED AS RICHTEK'S WARRANTY, EXPRESS OR IMPLIED, UNDER CONTRACT, TORT OR STATUTORY, WITH RESPECT TO THE PRESENTATION HEREIN. IN NO EVENT SHALL RICHTEK BE LIABLE TO BUYER OR USER FOR ANY AND ALL DAMAGES INCLUDING WITHOUT LIMITATION TO DIRECT, INDIRECT, SPECIAL, PUNITIVE OR CONSEQUENTIAL DAMAGES.

## Looking for pricing, stock, or lifecycle information?

Click below to explore more details on WIN SOURCE:

-  [View EVB\\_RT8086BGQUF on WIN SOURCE](#)
-  [Richtek USA Inc. Information](#)

## Optimize Your Supply Chain with WIN SOURCE Solutions

-  Global Sourcing Solution
-  Obsolete Management
-  Cost Control Management
-  Shortage Management
-  Alternative Solution
-  Excess Inventory Management