



**THE DATASHEET OF
ROV07-180M-S**



ROV07, ROV07H

7mm Series Metal Oxide Varistors

www.tycopowercomponents.com

Document: SCD 25481
Status: Released
Rev. A June 30, 2003

GENERAL DESCRIPTION

The ROV07-XXX (**R**adial-leaded Metal **O**xide **V**aristor) products are 7mm radial leaded varistor devices suitable for protection of overvoltage transients.

ROV devices can provide protection for a wide variety of power systems against overvoltage faults such as lightning, power contact and power induction. Suitable for a broad range of applications including, but not limited to security, power supplies, surge strips, etc., the ROV device helps to protect valuable equipment from potential power surge damage by clamping high energy, short duration impulses. The ROV devices have high current handling and energy absorption capability and fast response times to help protect against transient faults.

FEATURES

- Radial leaded
- Broad Varistor voltage and V_{rms} range
 - Varistor voltage : 18V - 820V
 - V_{rms} voltage : 11V - 510V
- Two surge capability series
 - Standard series, High surge series
- Various lead types
 - Straight, Kinked, Other
- Various packaging options
 - Bulk, Tape & Reel, Ammo Pack
- Helps designers meet the following standards
 - UL, CSA, VDE
- Fast response time
- High current and energy absorption capability

APPLICATIONS

- Power supplies and power systems
- Line voltage
- Telecommunications systems
- Automotive systems
- Appliances

TYPICAL APPLICATION SCHEMATIC

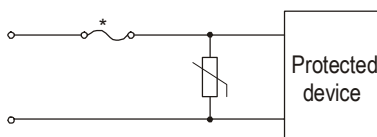

*In some applications, a polymeric PTC device such as a Tyco Electronics PolySwitch device may be used instead of a fuse to provide a preferred solution.

ROV07, ROV07H

7mm Series Metal Oxide Varistors

www.tycopowercomponents.com

Document: SCD 25481
Status: Released
Rev. A June 30, 2003

PART NUMBERING

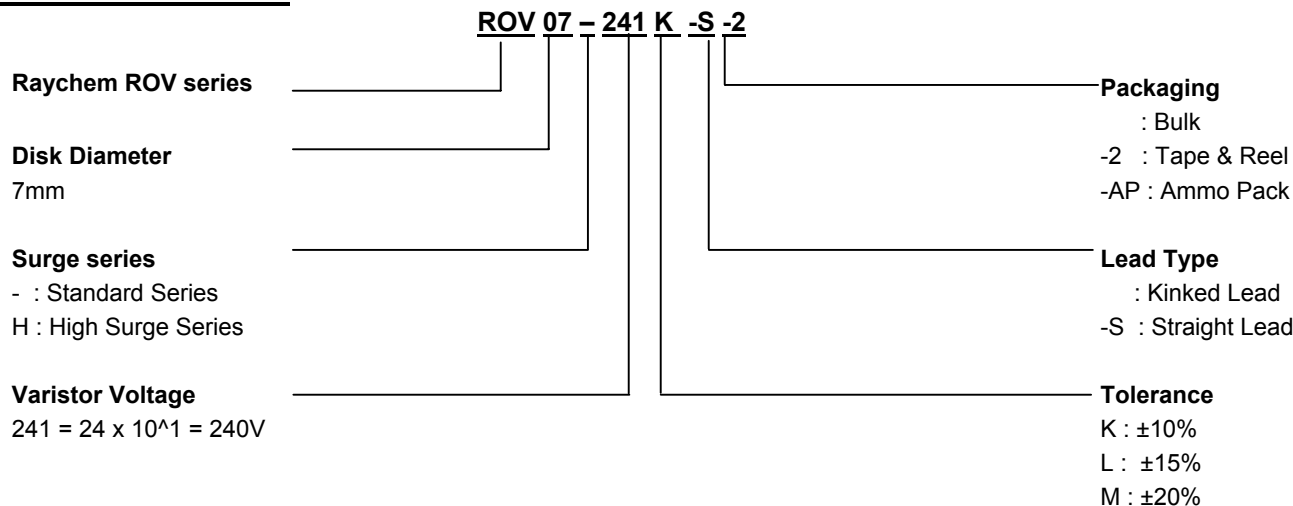

DEVICE MARKING

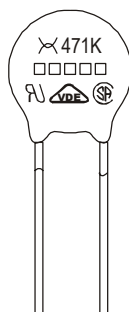
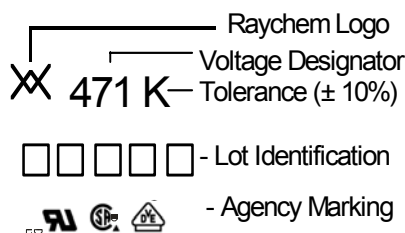

GENERAL CHARACTERISTICS

Storage temperature:	-40°C ... +125°C
Maximum operating temperature:	-40°C ... +125°C
Maximum working surface temperature:	+115°C
Temperature coefficient of voltage:	0 ... +0.05% / °C max.
Insulation resistance of coating (@ 500 VDC):	Over 1000MΩ
Maximum response time:	25ns
Lead Material:	22 AWG Sn/Pb Plated Copper

AGENCY RECOGNITION

Device Ratings and Characteristics Tables contain specific recognition information for each individual part. The table below details marking symbols for each agency recognition type.

UL1414	UL1449 (2nd Edition)	CSA	VDE
◆	●	▲	■

ROV07, ROV07H

7mm Series Metal Oxide Varistors

www.tycopowercomponents.com

Document: SCD 25481
 Status: Released
 Rev. A June 30, 2003

DEVICE RATINGS AND CHARACTERISTICS

STANDARD SERIES

Part Number	Varistor Voltage V@1.0mA		Maximum Allowable Voltage		Maximum Clamping Voltage V@10A	Maximum Surge Current (8x20us)		Rated Wattage	Energy (10x1000us)	Capacitance (Typical)	Certifications
	(V _{DC})	Tolerance	V _{rms} (V _{AC})	(V _{DC})	(V _{DC})	1 Time (A)	2 Times (A)	(W)	(J)	@1kHz (pF)	
ROV07-180M	18	± 20%	11	14	36 ¹⁾	250	125	0.02	1.2	2918	●
ROV07-220L	22	± 15%	14	18	43 ¹⁾				1.4	2933	●
ROV07-270K	27	± 10%	17	22	53 ¹⁾				1.7	2344	●
ROV07-330K	33		20	26	65 ¹⁾				2.2	1840	●
ROV07-390K	39		25	31	77 ¹⁾				2.4	1817	●
ROV07-470K	47		30	38	93 ¹⁾				3.0	1595	●
ROV07-560K	56		35	45	110 ¹⁾				3.5	1333	●
ROV07-680K	68		40	56	135 ¹⁾				4.3	1119	●
ROV07-820K	82		50	65	135				5.5	643	● ■
ROV07-101K	100		60	85	165	7.0	535	● ■			
ROV07-121K	120		75	100	200	8.0	457	● ■			
ROV07-151K	150	95	125	250	11.0	371	● ■				
ROV07-181K	180	115	150	300	13.0	215	● ■				
ROV07-201K	200	130	170	340	14.3	224	◆ ● ▲ ■				
ROV07-221K	220	140	180	360	15.5	190	◆ ● ▲ ■				
ROV07-241K	240	150	200	395	16.8	185	◆ ● ▲ ■				
ROV07-271K	270	175	225	455	19.8	161	◆ ● ▲ ■				
ROV07-301K	300	195	250	505	21.0	135	◆ ● ▲ ■				
ROV07-331K	330	210	275	550	23.0	141	◆ ● ▲ ■				
ROV07-361K	360	230	300	595	26.0	117	◆ ● ▲ ■				
ROV07-391K	390	250	320	650	30.0	110	◆ ● ▲ ■				
ROV07-431K	430	275	350	710	33.0	111	◆ ● ▲ ■				
ROV07-471K	470	300	385	775	35.0	102	◆ ● ▲ ■				
ROV07-511K	510	320	418	842	37.0	100	◆ ● ▲				
ROV07-561K	560	350	460	920	39.0	87	◆ ● ▲				
ROV07-621K	620	385	505	1025	41.0	80	◆ ● ▲				
ROV07-681K	680	420	560	1120	43.0	82	◆ ● ▲				
ROV07-751K	750	460	615	1240	45.0	74	◆ ● ▲				
ROV07-781K	780	485	640	1290	46.0	70	◆ ● ▲				
ROV07-821K	820	510	670	1355	47.0	70	◆ ● ▲				

1). The clamping voltage for devices ROV07-180M to ROV07-680K is tested with 2.5A current.

ROV07, ROV07H

7mm Series Metal Oxide Varistors

www.tycopowercomponents.com

Document: SCD 25481
Status: Released
Rev. A June 30, 2003

PULSE LIFETIME RATING CURVES

V-I CHARACTERISTIC CURVES

STANDARD SERIES

STANDARD SERIES

ROV07-180M – ROV07-680K

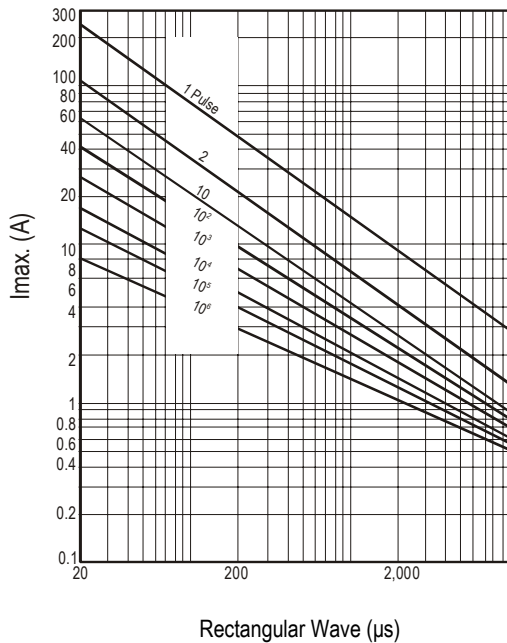

ROV07-180M – ROV07-680K

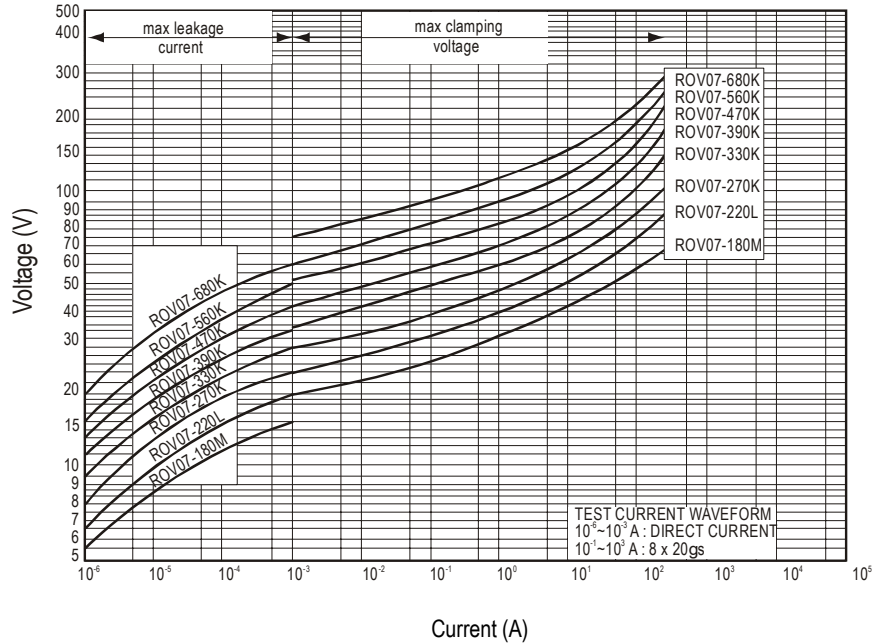

ROV07-820K – ROV07-821K

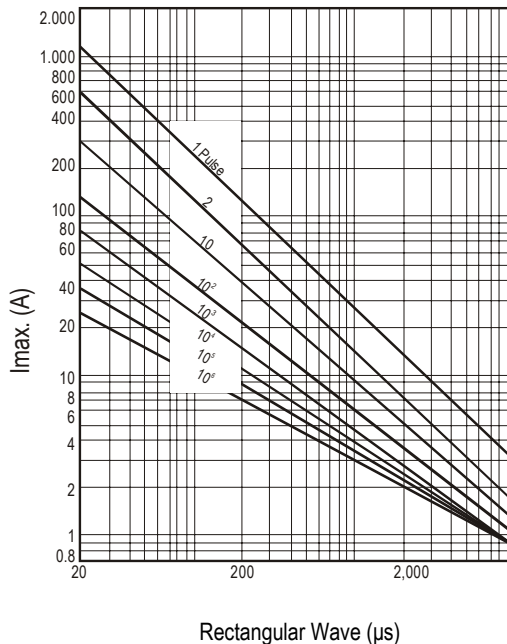

ROV07-820K – ROV07-821K

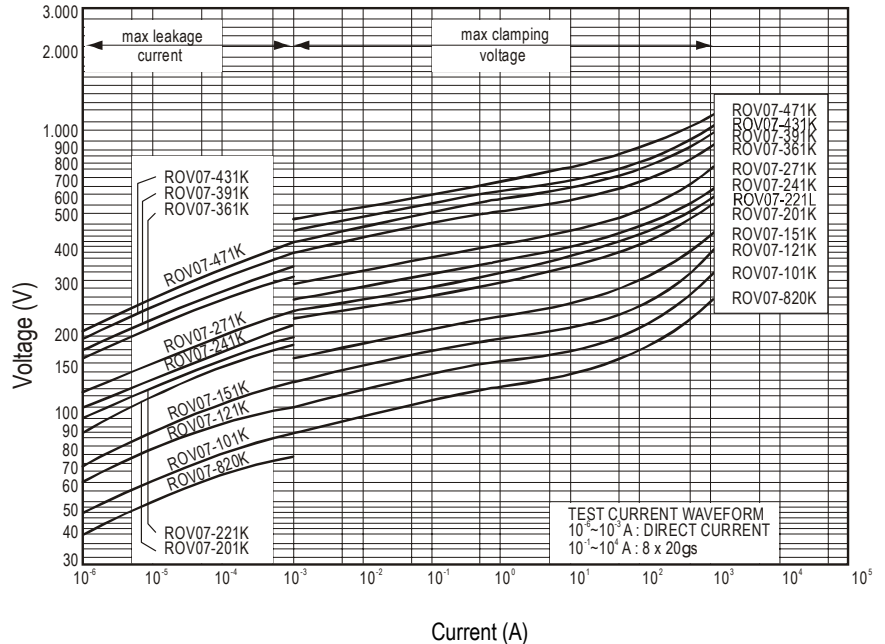

ROV07, ROV07H

7mm Series Metal Oxide Varistors

www.tycopowercomponents.com

Document: SCD 25481
Status: Released
Rev. A June 30, 2003

DEVICE RATINGS AND CHARACTERISTICS

HIGH SURGE SERIES

Part Number	Varistor Voltage V@1.0mA		Maximum Allowable Voltage		Maximum Clamping Voltage V@10A	Maximum Surge Current (8x20us)		Rated Wattage	Energy (10x1000us)	Capacitance (Typical)	Certifications
	(V _{DC})	Tolerance	V _{rms} (V _{AC})	(V _{DC})	(V _{DC})	1	2	(W)	(J)	@1kHz (pF)	
						Time (A)	Times (A)				
ROV07H180M	18	± 20%	11	14	36 ¹⁾	500	250	0.02	1.5	2920	●
ROV07H220L	22	± 15%	14	18	43 ¹⁾				1.7	2930	●
ROV07H270K	27	± 10%	17	22	53 ¹⁾				2.1	2340	●
ROV07H330K	33		20	26	65 ¹⁾				2.8	1840	●
ROV07H390K	39		25	31	77 ¹⁾				3.0	1820	●
ROV07H470K	47		30	38	93 ¹⁾				3.8	1600	●
ROV07H560K	56		35	45	110 ¹⁾				4.4	1330	●
ROV07H680K	68		40	56	135 ¹⁾				5.4	1120	●
ROV07H820K	82		50	65	135				7.0	640	●
ROV07H101K	100		60	85	165				9.0	540	●
ROV07H121K	120		75	100	200	11.0	460	●			
ROV07H151K	150		95	125	250	13.0	370	●			
ROV07H181K	180	115	150	300	16.0	220	●				
ROV07H201K	200	130	170	340	17.5	220	◆ ● ▲				
ROV07H221K	220	140	180	360	19.0	190	◆ ● ▲				
ROV07H241K	240	150	200	395	21.0	190	◆ ● ▲				
ROV07H271K	270	175	225	455	24.0	160	◆ ● ▲				
ROV07H301K	300	195	250	505	26.0	140	◆ ● ▲				
ROV07H331K	330	210	275	550	1750	1250	0.25	28.0	140	◆ ● ▲	
ROV07H361K	360	230	300	595				32.0	120	◆ ● ▲	
ROV07H391K	390	250	320	650				35.0	110	◆ ● ▲	
ROV07H431K	430	275	350	710				40.0	110	◆ ● ▲	
ROV07H471K	470	300	385	775				42.0	100	◆ ● ▲	
ROV07H511K	510	320	418	842				45.0	100	◆ ● ▲	
ROV07H561K	560	350	460	920				51.0	85	◆ ● ▲	
ROV07H621K	620	385	505	1025				54.0	80	◆ ● ▲	
ROV07H681K	680	420	560	1120				56.0	80	◆ ● ▲	
ROV07H751K	750	460	615	1240				58.0	75	◆ ● ▲	
ROV07H781K	780	485	640	1290	59.0	70	◆ ● ▲				
ROV07H821K	820	510	670	1355	60.0	70	◆ ● ▲				

1). The clamping voltage for devices ROV07H180M to ROV07H680K is tested with 2.5A current.

ROV07, ROV07H
7mm Series Metal Oxide Varistors

www.tycopowercomponents.com

Document: SCD 25481
Status: Released
Rev. A June 30, 2003

PULSE LIFETIME RATING CURVES

V-I CHARACTERISTIC CURVES

HIGH SURGE SERIES

HIGH SURGE SERIES

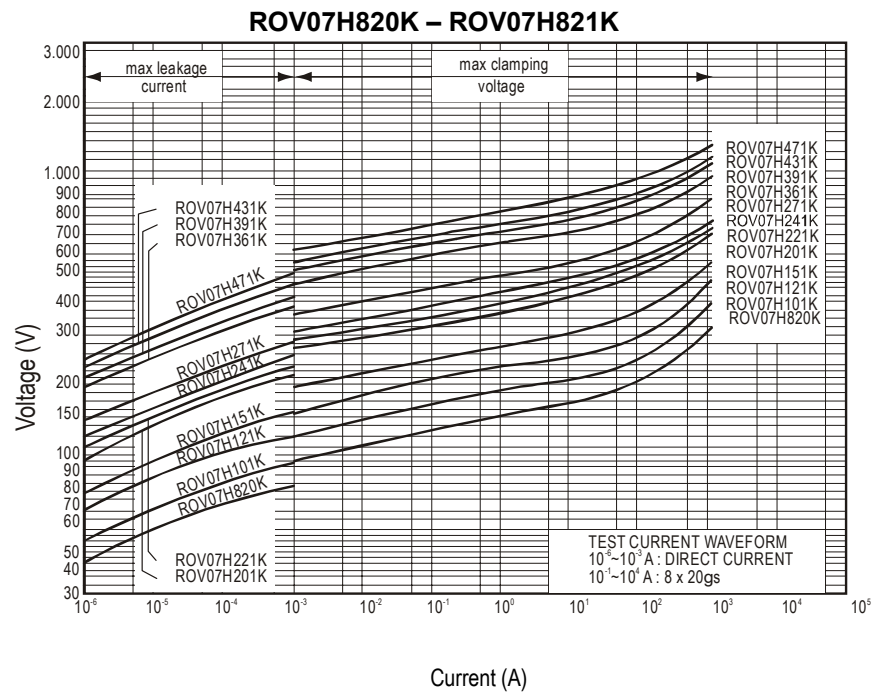
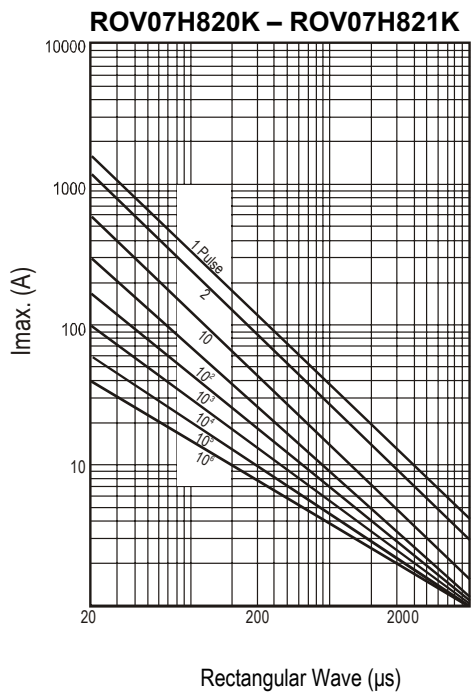
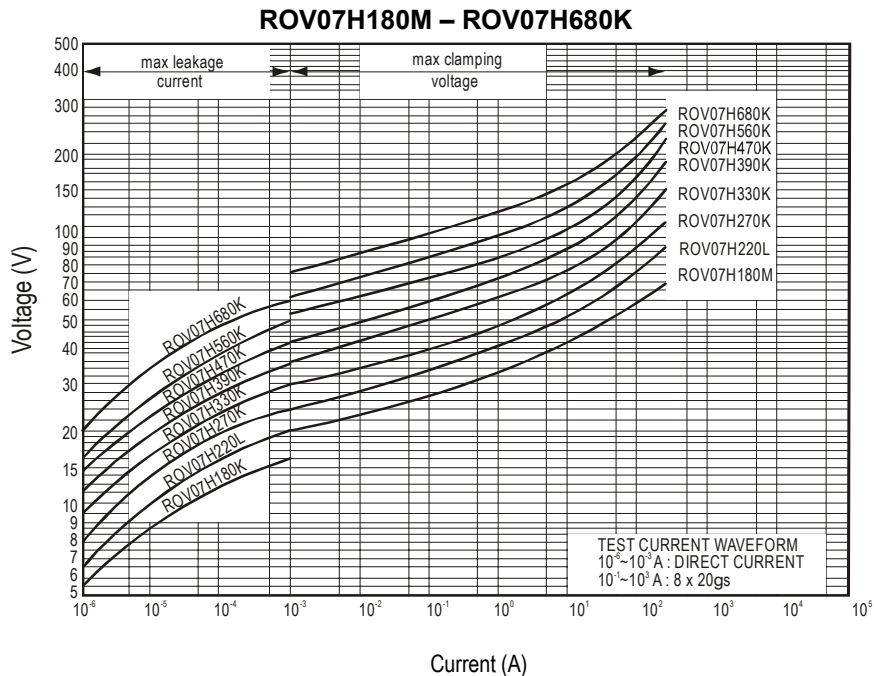
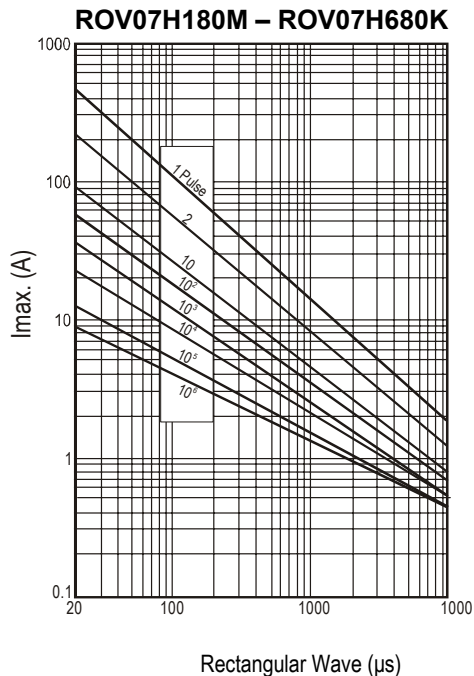

ROV07, ROV07H
7mm Series Metal Oxide Varistors

www.tycopowercomponents.com

Document: SCD 25481
Status: Released
Rev. A June 30, 2003

DIMENSIONS

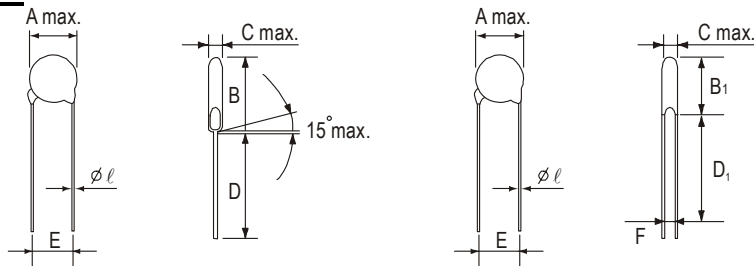

KINKED LEAD TYPE
Dimension Table

A max.	9.0
$l \pm 0.05$	0.6
$E \pm 1.0$	5.0
B max.	13.0
D_1 min.	25.0
D min.	24.0

STRAIGHT LEAD TYPE (-S)
Table of C max., F, and B₁ max.

Type No.	C max.	F±0.8	B ₁ max.
180M	4.5	0.8	12.0
220L	4.5	0.9	12.0
270K	4.7	0.9	12.0
330K	4.7	1.0	12.0
390K	4.7	1.2	12.0
470K	5.0	1.2	12.0
560K	5.0	1.4	12.0
680K	5.5	1.7	12.0
820K	3.8	0.8	12.0
101K	3.9	0.8	12.0
121K	4.1	0.9	12.0
151K	4.5	1.2	12.0
181K	4.1	1.0	12.0
201K	4.2	1.0	12.0
221K	4.3	1.1	12.0
241K	4.4	1.3	12.0
271K	4.6	1.4	12.0
301K	4.8	1.5	12.0
331K	4.9	1.5	12.0
361K	5.1	1.9	12.0
391K	5.3	2.0	12.5
431K	6.1	2.3	12.5
471K	6.4	2.3	12.5
511K	6.6	2.5	13.0
561K	6.9	2.8	13.0
621K	7.2	3.1	13.0
681K	7.5	3.4	13.0
751K	7.9	3.7	13.0
781K	8.1	3.9	13.0
821K	8.3	4.1	13.0

ROV07, ROV07H

7mm Series Metal Oxide Varistors

www.tycopowercomponents.com

Document: SCD 25481
Status: Released
Rev. A June 30, 2003

PACKAGING

in mm

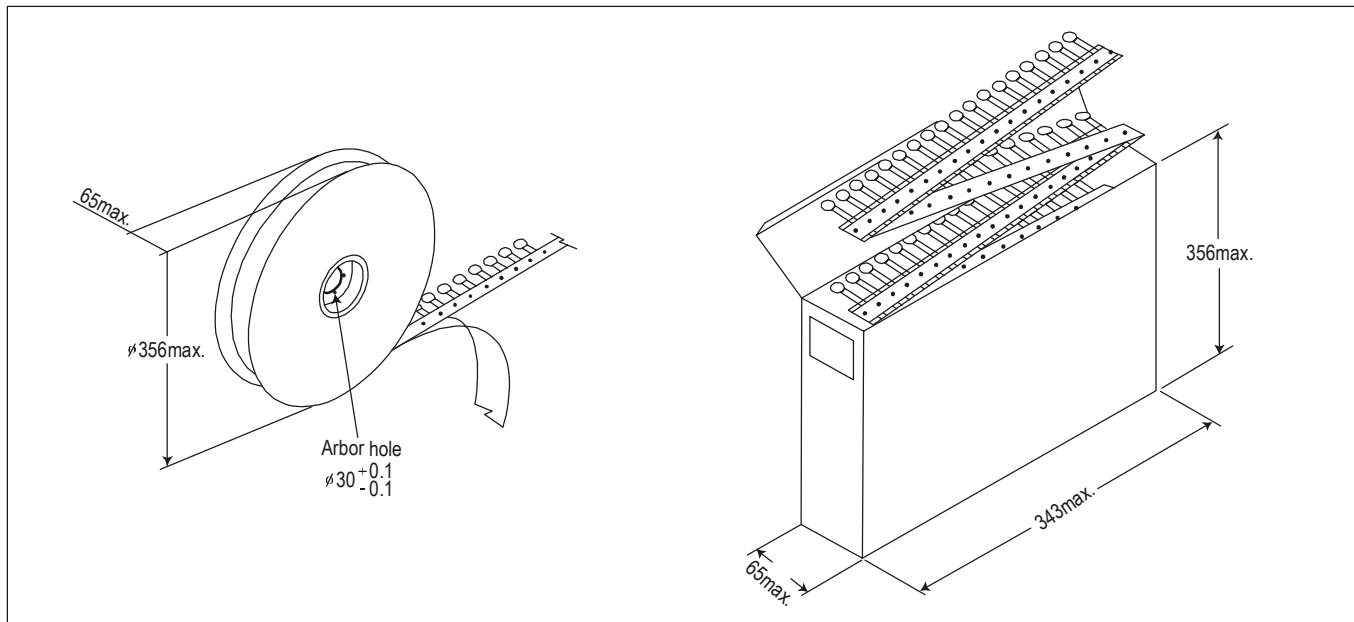

Packaging	Bulk (box)	Reel	Ammo
Box size (mm)	290 x 155 x 110	350 x 350 x 108	330 x 240 x 45
Carton size (mm)	310 x 328 x 250	371 x 371 x 590	354 x 515 x 258
One carton with	4 Boxes	5 Boxes (10 reels)	10 Boxes

Part Number	Bulk (box)	Reel	Ammo
ROV07-180M to ROV07-470K ROV07H180M to ROV07H470K	5000	1500	1500
ROV07-560K to ROV07-680K ROV07H560K to ROV07H680K	5000	1500	1000
ROV07-820K to ROV07-331K ROV07H820K to ROV07H331K	5000	1500	1500
ROV07-361K to ROV07-391K ROV07H361K to ROV07H391K	5000	1500	1000
ROV07-431K to ROV07-471K ROV07H431K to ROV07H471K	5000	1000	1000
ROV07-511K to ROV07-751K ROV07H511K to ROV07H751K	4000	1000	1000
ROV07-781K to ROV07-821K ROV07H781K to ROV07H821K	4000	1000	1000

ROV07, ROV07H
7mm Series Metal Oxide Varistors

www.tycopowercomponents.com

Document: SCD 25481
Status: Released
Rev. A June 30, 2003

TAPE AND REEL DIMENSIONS

1/2" Pitch

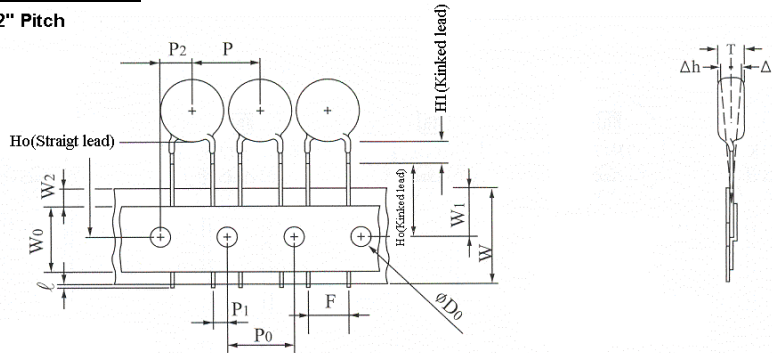

1.0" Pitch

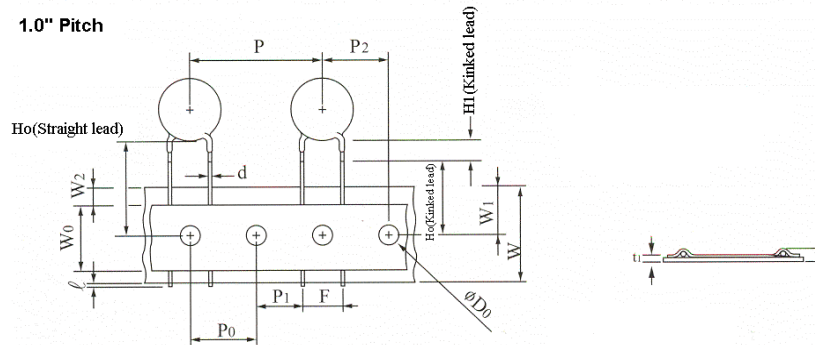

Symbols	Item	Value
ℓ	Cut out length	1.1mm max.
H_1 (Kinked lead)	Height of kink	3.5mm max.
H_o (Kinked lead)	Height to seating plane	16.0 ± 0.5mm
H_o (Straight lead)	Height of component from hole center	16.0-21.0mm
Δh	Front to back deviation	0.0 ± 2.0mm
W	Carrier tape width	18.0 ^{+1.0} _{-0.5} mm
W_0	Hold down tape width	10.0mm
W_1	Sprocket hole position	9.0 ^{+0.75} _{-0.5} mm
W_2	Adhesive tape position	3.0mm max.
F	Component lead spacing	5.0 ^{+0.8} _{-0.2} mm
P	Pitch of component	12.7 ± 1.0mm
P_0	Sprocket hole pitch	12.7 ± 0.3mm
P_1	Lead length from hole center to lead	3.85 ± 0.7mm
P_2	Length from hole center to disk center	6.35 ± 1.3mm
D_0	Sprocket hole diameter	4.0 ± 0.2mm
d	Lead wire diameter	0.6 ± 0.05mm
T	Disk thickness	See C. max table
t_1	Total thickness tape	0.7 ± 0.05mm
t_2	Total thickness	1.6mm max.



ROV07, ROV07H

7mm Series Metal Oxide Varistors

www.tycopowercomponents.com

Document: SCD 25481
Status: Released
Rev. A June 30, 2003

Information furnished is believed to be accurate and reliable. However, users should independently evaluate the suitability of each product for their applications. Tyco Electronics Corporation assumes no responsibility for the use of its product or for any infringement of patents or other rights of third parties resulting from the use of its product. No license is granted by implication or otherwise under any patent or proprietary right of Tyco Electronics except the right to use such product for the purpose for which it is sold. Tyco Electronics reserves the right to change or update, without notice, any information contained in this publication; to change, without notice, the design, construction, processing, or specification of any product; and to discontinue or limit production or distribution of any product. This publication supersedes and replaces all information previously supplied. Without express written consent by an officer of Tyco Electronics, Tyco Electronics does not authorize the use of any its products as components in nuclear facility applications, aerospace, or in critical life support devices or systems. Tyco Electronics' only obligations are those in the Tyco Electronics Standard Terms and Conditions of Sale and in no case will Tyco Electronics be liable for any incidental, indirect, or consequential damages arising from the sale, resale, use, or misuse of its products.

Raychem is a trademark of Tyco Electronics Corporation

© 2003 Tyco Electronics Corporation

Looking for pricing, stock, or lifecycle information?

Click below to explore more details on WIN SOURCE:

 [View ROV07-180M-S on WIN SOURCE](#)

 [Littelfuse Inc. Information](#)

Optimize Your Supply Chain with WIN SOURCE Solutions

-  Global Sourcing Solution
-  Obsolete Management
-  Cost Control Management
-  Shortage Management
-  Alternative Solution
-  Excess Inventory Management