



THE DATASHEET OF RJ13P204



SINGLE TURN CERMET TRIMMERS

RJ-13

RoHS compliant

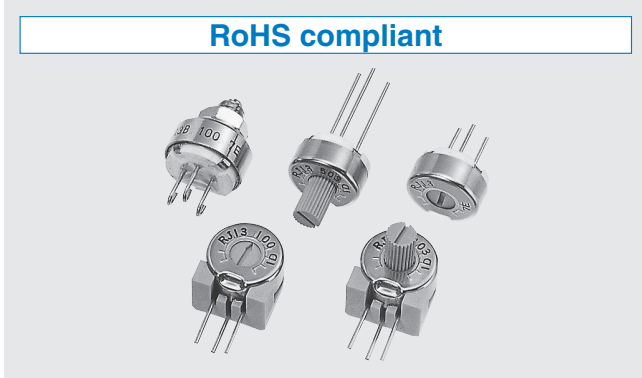

FEATURES

- RoHS compliant
- Wide resistance range from 10 Ω to 5 M Ω
- Precious metal alloy wiper

INTERNAL STRUCTURE

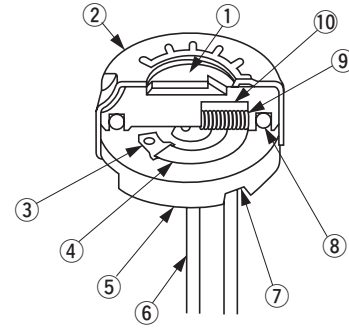





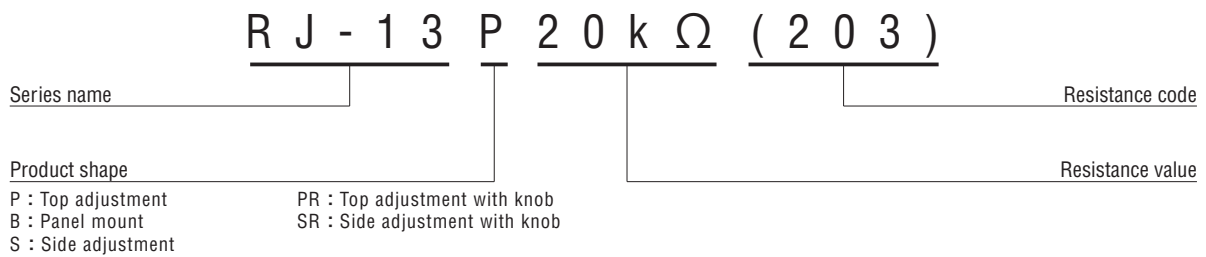

	Part name	Material	Flammability
①	Rotor	Polybutyleneterephthalate	UL94HB
②	Cover	Stainless steel	—
③	Electrode	Ag-Pd cermet	
④	Resistive element	RuO ₂ cermet	
⑤	Base element	Ceramic	
⑥	Terminal pin	Nickel, Gold-plated	
⑦	Adhesive	Epoxy	UL94HB
⑧	“O” ring	Silicone rubber	
⑨	Wiper	Multi metal alloy	
⑩	Rubber cushion	Silicone rubber	—

PART NUMBER DESIGNATION



※ Please refer to the LIST OF PART NUMBERS when placing orders.

LIST OF PART NUMBERS

Adjustment position	Shape of terminal (Top view)	Form of packaging	Pieces in package
		Plastic bag	
 Top adjustment		RJ-13P	50 pcs./pack 25 pcs./pack
		RJ-13B	
		RJ-13PR	
 Side adjustment (↑ Adjustment direction)		RJ-13S	
		RJ-13SR	

◁Nominal resistance values▷

➡ 10 Ω	➡ 20 Ω	50 Ω	100 Ω	200 Ω	500 Ω	1 k Ω	2 k Ω	5 k Ω	10 k Ω
20 k Ω	➡ 25 k Ω	50 k Ω	100 k Ω	200 k Ω	➡ 250 k Ω	500 k Ω	1 M Ω	2 M Ω	➡ 5 M Ω

Fig. 1

※ The above part numbers are all available with the respective combination of <Nominal resistance values> (Fig. 1).

※ Verify the above part numbers when placing orders.

The products indicated by ➡ mark are manufactured upon receipt of order basis.

ELECTRICAL CHARACTERISTICS

Nominal resistance range	10 Ω ~ 5 M Ω
Resistance tolerance	± 10 %
Power ratings	0.75 W (70 °C) 0 W (120 °C)
Resistance law	(B) Linear law
Maximum input voltage	DC300 V or power rating, whichever is smaller
Maximum wiper current	100 mA or power rating, whichever is smaller
Effective electrical angle	230 ° (1 turn)
End resistance	1 % or 2 Ω , whichever is greater
C.R.V.	1 % or 3 Ω , whichever is greater
Operating temp. range	− 55 ~ 120 °C
Temp. coefficient	10 Ω , 20 Ω , 5 M Ω : ± 250 10 ⁻⁶ /°C maximum 50 Ω ~ 2 M Ω : ± 100 10 ⁻⁶ /°C maximum
Insulation resistance	1000 M Ω minimum (DC500 V)
Dielectric strength	AC900 V, 60 s
Net weight	Approx. 1.90 g (RJ-13P) Approx. 4.50 g (RJ-13B) Approx. 2.15 g (RJ-13PR) Approx. 2.50 g (RJ-13S) Approx. 2.78 g (RJ-13SR)

MECHANICAL CHARACTERISTICS

Mechanical angle	270 ° (1 turn)
Operating torque	3 ~ 35 mN·m {30.6~357 gf·cm}
Stop strength	100 mN·m {1.02 kgf·cm}
Rotational life	200 cycles 10 Ω ~ 200 Ω [Δ R/R ≤ ± (0.5 Ω + 3 %)] 500 Ω ~ 5 M Ω [Δ R/R ≤ ± (0.5 Ω + 2 %)]
Terminal to strength	20 N {2.04 kgf} minimum (Tensile strength)
Thrust to rotor	10 N {1.02 kgf} minimum
Solderability	245 ± 3 °C, 2 ~ 3 s

{ } : Reference only

ENVIRONMENTAL CHARACTERISTICS

Test item	Test conditions	Specifications
Thermal shock	− 65 ~ 125 °C (0.5 h), 5 cycles	[Δ R/R ≤ 1 %] [S.S. ≤ 1 %]
Humidity	− 10 ~ 65 °C (80 ~ 98 %), 10 cycles, 240 h	[Δ R/R ≤ 1 %]
Shock	981 m/s ² , 6 ms 6 directions for 3 times each	[Δ R/R ≤ 1 %] [S.S. ≤ 1 %]
Vibration	(Amplitude) 1.52 mm or (Acceleration) 196 m/s ² , 10 ~ 2000 Hz, 3 directions, 12 times each	
Load life	70 °C, 0.75 W, 1000 h	[Δ R/R ≤ 2 %] [S.S. ≤ 1 %]
Low temp. operation	− 55 °C, 2 h	[Δ R/R ≤ 1 %] [S.S. ≤ 2 %]
High temp. exposure	120 °C, 250 h	[Δ R/R ≤ 2 %] [S.S. ≤ 2 %]
Immersion seal	85 °C, 60 s	No leaks (No continuous bubbles)
Soldering heat	Flow 260 ± 3 °C, 5 ~ 6 s, two times maximum	[Δ R/R ≤ 1 %]
	Manual soldering 380 ± 10 °C, 3 ~ 4 s	

Δ R/R : Change in total resistance
S.S. : Setting stability

RJ-13

CERMET TRIMMERS

MAXIMUM INPUT RATINGS

Nominal resistance value (Ω)	Resistance code	Maximum input voltage (V)	Maximum wiper current (mA)
<ul style="list-style-type: none"> ➔ 10 ➔ 20 50 100 200 500 	<ul style="list-style-type: none"> 100 200 500 101 201 501 	<ul style="list-style-type: none"> 1.00 2.00 5.00 8.66 12.2 19.4 	<ul style="list-style-type: none"> 100 100 100 86.6 61.0 38.8
<ul style="list-style-type: none"> 1 k 2 k 5 k 10 k 20 k ➔ 25 k 50 k 	<ul style="list-style-type: none"> 102 202 502 103 203 253 503 	<ul style="list-style-type: none"> 27.4 38.7 61.2 86.6 122 137 194 	<ul style="list-style-type: none"> 27.4 19.3 12.2 8.66 6.10 5.48 3.88
<ul style="list-style-type: none"> ➔ 100 k ➔ 200 k ➔ 250 k 500 k ➔ 1 M ➔ 2 M ➔ 5 M 	<ul style="list-style-type: none"> 104 204 254 504 105 205 505 	<ul style="list-style-type: none"> 274 300 300 300 300 300 300 	<ul style="list-style-type: none"> 2.74 1.50 1.20 0.60 0.30 0.15 0.06

The products indicated by ➔ mark are manufactured upon receipt of order basis.

OUTLINE DIMENSIONS

Unless otherwise specified, tolerance: ± 0.3 (Unit: mm)

RJ-13P Top adjustment

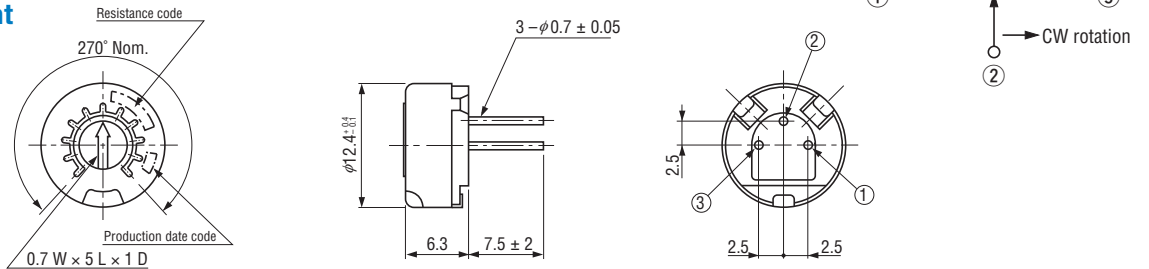

RJ-13B Panel mount

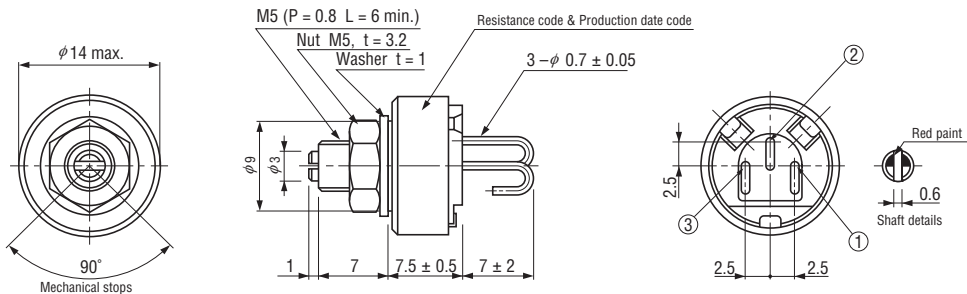

RJ-13PR Top adjustment with knob

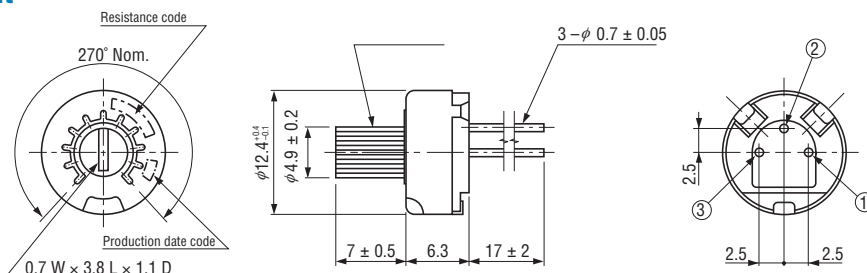

OUTLINE DIMENSIONS

● RJ-13S Side adjustment

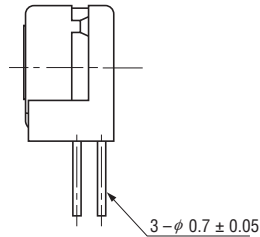
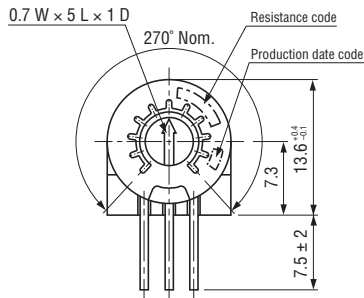

Unless otherwise specified, tolerance: ± 0.3 (Unit: mm)

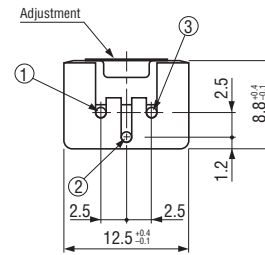
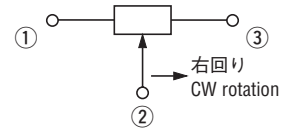

● RJ-13SR Side adjustment with knob

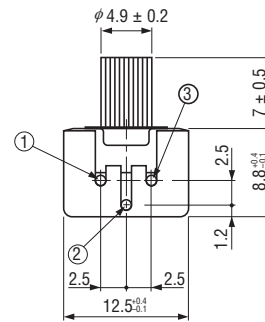
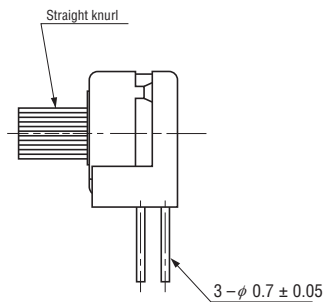
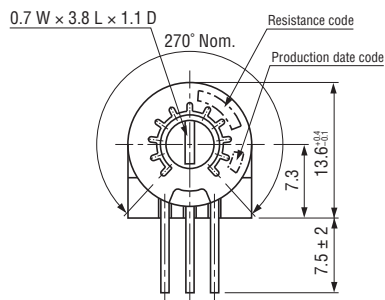



PACKAGING SPECIFICATIONS

<Bulk pack specifications>

- Unit of bulk pack in a plastic bag is 25 pcs. per pack, only that RJ-13P is 50 pcs. per pack.
- Boxing of bulk in a plastic bag is performed with 50 pcs. per box, only that RJ-13P is 100 pcs. per box.

Looking for pricing, stock, or lifecycle information?

Click below to explore more details on WIN SOURCE:

-  [View RJ13P204 on WIN SOURCE](#)
-  [Copal Electronics Inc. Information](#)

Optimize Your Supply Chain with WIN SOURCE Solutions

-  Global Sourcing Solution
-  Obsolete Management
-  Cost Control Management
-  Shortage Management
-  Alternative Solution
-  Excess Inventory Management