



**THE DATASHEET OF  
RCD-24-0.35/PL/A-R**



# Features

## Regulated Converters

- SMD Constant Current LED Driver
- Built-in Class A or Class B EMC Filter
- Wide Input and Output Voltage Range
- Digital PWM and Analogue Voltage Dimming
- Short Circuit and Overtemperature Protected
- Low Cost
- EN/RAILWAYS Certified
- 5 Year Warranty

### Description

The RCD-24-xxx/PL series is a step-down constant current source designed for driving high power LEDs. The converter uses a pinless SMD open frame design to reduce cost and size. Output currents available are 300mA, 350mA, 500mA, 600mA, 700mA and 1000mA with either Class A (Suffix /A) or Class B (suffix /B) built-in EMC filtering. Despite its compact size, the RCD-PL series is fully featured with very high efficiency, wide input voltage range, high ambient operating temperature and two means of LED dimming: PWM/digital control and analogue voltage dimming. Both dimming controls are independent and can be combined. The driver is also designed to be as reliable as the LEDs it is driving, even at the full ambient operating temperature and is designed for strip lighting, wall washers and fluorescent tube replacement designs, where a low profile and narrow width are demanded.

### Selection Guide

Part Number	Input Range (VDC)	Output Current (mA)	Output Voltage (Vmin-Vmax)	Dimming Control	Mounting Style
RCD-24-0.30/PL*	4.5-36V	0-300	2-35	Digital + Analogue	Pinless SMD
RCD-24-0.35/PL*	4.5-36V	0-350	2-35	Digital + Analogue	Pinless SMD
RCD-24-0.50/PL*	4.5-36V	0-500	2-35	Digital + Analogue	Pinless SMD
RCD-24-0.60/PL*	4.5-36V	0-600	2-35	Digital + Analogue	Pinless SMD
RCD-24-0.70/PL*	4.5-36V	0-700	2-35	Digital + Analogue	Pinless SMD
RCD-24-1.00/PL/A	6-36V	0-1000	2-32	Digital + Analogue	Pinless SMD

\* /A for EMC Class A input Filter add -R for Tape and Reel Packaging e.g. RCD-24-0.35/PL/B-R

\* /B for EMC Class B input Filter

Note: RCD-24-1.00/PL/A only available with Class A Filter

### Specifications (typical at 25°C, nominal input voltage, rated output current unless otherwise specified)

Input Voltage (absolute maximum)	40VDC max	
Recommended Input Voltage	6V min. / 24V typ. / 36VDC max	
Input Filter	Suffix /A	Capacitor
	Suffix /B	Class B with Pi Filter
	RCD-24-1.00/PL/A	Class A with Pi Filter
Output Current Accuracy (Vin=24V)	300-700mA	±2% typ, ±3% max
	1000mA	±3% typ, ±5% max
Internal Power Dissipation	Worst case load of 5 LEDs (300-700mA)	700mW max.
	Worst case load of 8 LEDs (1000mA), Vin=36V	1.6W typ.
Output Current Stability	Vin = 36V, Vout = 1-9 LEDs (300-700mA)	±1% max
	Vin = 36V, Vout = 1-8 LEDs (1000mA)	± 1.5% max.
Output Ripple and Noise (20MHz BW)	Vin=36V, Vout = 1-9 LEDs (300-700mA)	300mVp-p max
	Vin=36V, Vout = 1-8 LEDs (1000mA)	
Temperature Coefficient	-40°C to +85°C ambient ±0.015%/°C max	
Maximum Capacitive Load	100µF	
Operating Frequency	300-1000mA	212kHz min/ 250kHz typ/ 280kHz max
Efficiency at Full Load	300-700mA	96% typ.
	Vin=36V, Vout=8 LEDs (1000mA)	94% typ.
Short Circuit Protection	Regulated at rated output current	
Operating Temperature Range	300/350mA	-40°C to +85°C
	500mA	-40°C to +80°C
	600/700mA	-40°C to +75°C
	1000mA	-40°C to +65°C
Storage Temperature Range	-55°C to +125°C	
Relative Humidity	5% to 95% RH, non-condensing	

continued on next page

# LIGHTLINE

## DC/DC-Converter

with 5 year Warranty

# RECOM

## Constant Current LED Driver



**E358085**

**EN-50121-3-2 Certified**

**EN-60950-1 Certified**

**UL-60950-1 Certified**

# RCD-24/PL

## Derating-Graph

(Ambient Temperature)

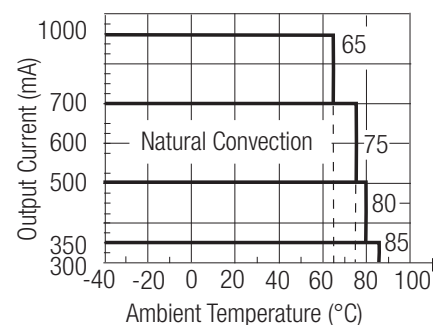

Refer to Application Notes

**Specifications** (typical at 25°C, nominal input voltage, rated output current unless otherwise specified )

Dimensions	31.0 x 11.4 x 6.6mm	
Weight	1.9g	
Packing Quantity	12 pcs per Tube / 400 pcs per Reel	
Reflow Soldering Profile	265°C/10 sec max	
MTBF	(using MIL HDBK 217F) +25°C	>600 khours
<b>PWM Dimming and ON/OFF Control</b> (Leave open if not used)		
Remote ON/OFF	DC/DC ON	Open or $0V < V_r < 0.6V$
Threshold Voltages	DC/DC OFF (Standby)	$0.6 < V_r < 2.9V$
	DC/DC OFF (Full Shutdown)	$2.9V < V_r < 6V$
Remote Pin Drive Current	$V_r = 5V$	1mA max
Quiescent Input Current in Shutdown Mode	$V_{in} = 36V$	200µA max
Recommended PWM Frequency (measured 10%~90% Dimming)	For Linear Operation	200Hz
	Maximum Frequency	1000Hz
<b>Analogue Dimming Control</b> (leave open if not used)		
Input Voltage Range	300-1000mA	-0.3V - 15V
Control Voltage Range Limits (see Graph)	300-1000mA / Full On	$0.13V \pm 50mV$
	300-700mA / Full Off	$4.2V \pm 150mV$
	1000mA / Full Off	$4.35V \pm 100mV$
Analogue Pin Drive Current	300-1000mA / $V_c = 5V$	0.2mA max.
<b>Environmental</b>		
Shock / Vibration	EN61373	
EMC Railways	EN50121-3-2:2006	
Conducted Emissions	300-1000mA (/A Suffix)	EN55022, Class A
	300-700mA (/B Suffix)	EN55022, Class B
Radiated Emissions	EN55022, Class B	
ESD	EN61000-4-2, Criterion A	
Radiated Immunity	EN61000-4-3, Criterion A	
Fast Transient	EN61000-4-4, Criterion A	
Conducted Immunity	EN61000-4-6, Criterion A	

**Note:**

- All LED Drivers may not be used without a load. They must be switched on the primary side only. Noncompliance may damage the LED or reduce its lifetime.
- It is not possible to parallel the drivers to increase the current.

**Typical Characteristics**

$V_{in} = 24V, I_{out} = 300 \sim 1000mA$

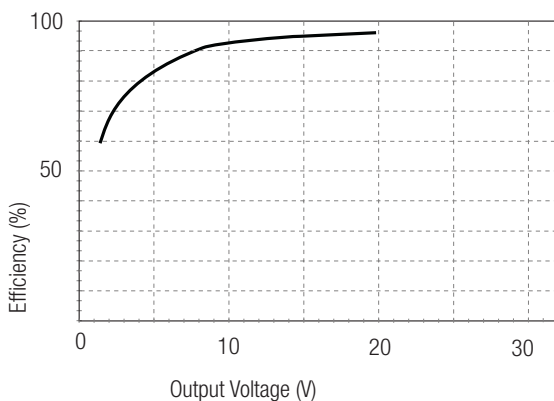

$V_{in} = 32V, I_{out} = 300 \sim 1000mA$

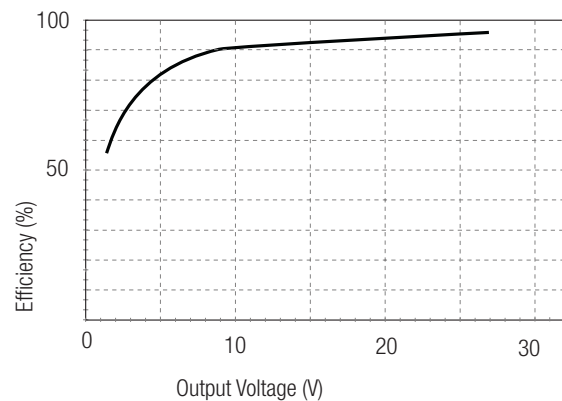

## Dimming

### Digital Dimming

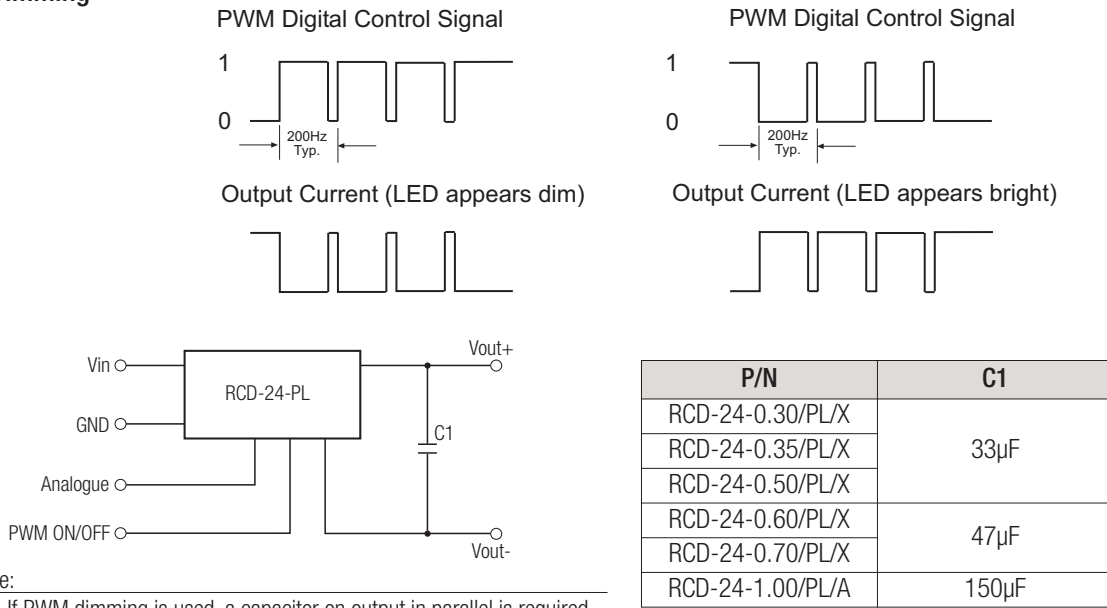

Note:

- If PWM dimming is used, a capacitor on output in parallel is required.

### Analogue Dimming

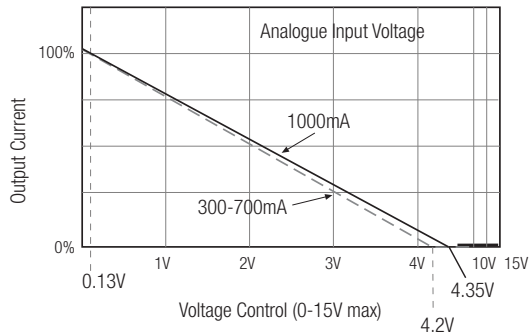

## Package Style and Pinning

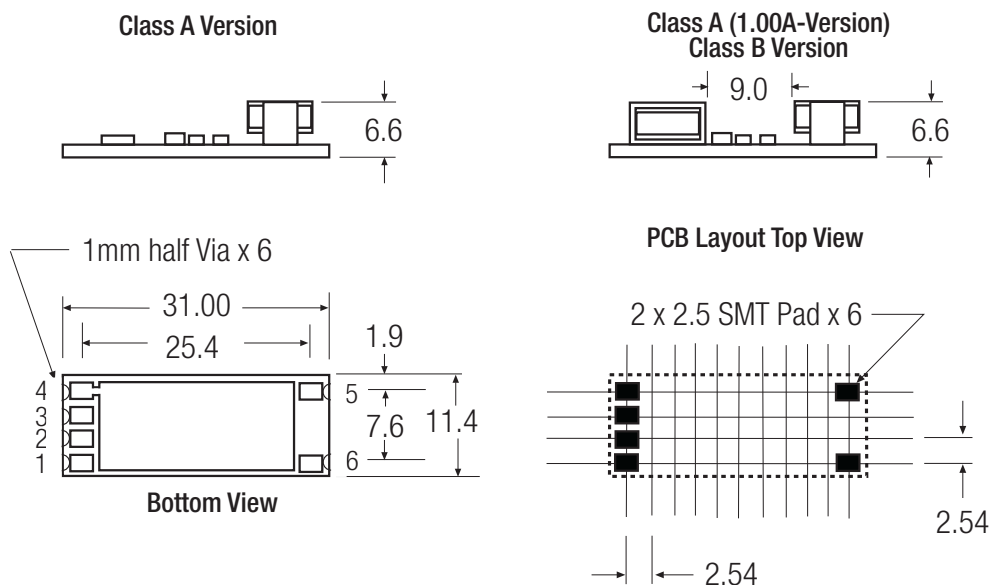



Pad #	Out	Comments
1	+Vin	DC Supply
2	Analogue Dimming	Leave open if not used
3	PWM/ON/OFF	Leave open if not used
4	GND	Do not connect to -Vout
5	-Vout	LED Cathode Connection
6	+Vout	LED Anode Connection

XX.X ± 0.5 mm  
XX.XX ± 0.25 mm

The product information and specifications are subject to change without prior notice. RECOM products are not authorized for use in safety-critical applications (such as life support) without RECOM's explicit written consent. A safety-critical application is defined as an application where a failure of a RECOM product may reasonably be expected to endanger or cause loss of life, inflict bodily harm or damage property. The buyer shall indemnify and hold harmless RECOM, its affiliated companies and its representatives against any damage claims in connection with the unauthorized use of RECOM products in such safety-critical applications.

## Looking for pricing, stock, or lifecycle information?

Click below to explore more details on WIN SOURCE:

-  [View RCD-24-0.35/PL/A-R on WIN SOURCE](#)
-  [Recom Power Information](#)

## Optimize Your Supply Chain with WIN SOURCE Solutions

-  Global Sourcing Solution
-  Obsolete Management
-  Cost Control Management
-  Shortage Management
-  Alternative Solution
-  Excess Inventory Management