

To our customers,

Old Company Name in Catalogs and Other Documents

On April 1st, 2010, NEC Electronics Corporation merged with Renesas Technology Corporation, and Renesas Electronics Corporation took over all the business of both companies. Therefore, although the old company name remains in this document, it is a valid Renesas Electronics document. We appreciate your understanding.

Renesas Electronics website: <http://www.renesas.com>

April 1st, 2010
Renesas Electronics Corporation

Issued by: Renesas Electronics Corporation (<http://www.renesas.com>)

Send any inquiries to <http://www.renesas.com/inquiry>.

Notice

1. All information included in this document is current as of the date this document is issued. Such information, however, is subject to change without any prior notice. Before purchasing or using any Renesas Electronics products listed herein, please confirm the latest product information with a Renesas Electronics sales office. Also, please pay regular and careful attention to additional and different information to be disclosed by Renesas Electronics such as that disclosed through our website.
2. Renesas Electronics does not assume any liability for infringement of patents, copyrights, or other intellectual property rights of third parties by or arising from the use of Renesas Electronics products or technical information described in this document. No license, express, implied or otherwise, is granted hereby under any patents, copyrights or other intellectual property rights of Renesas Electronics or others.
3. You should not alter, modify, copy, or otherwise misappropriate any Renesas Electronics product, whether in whole or in part.
4. Descriptions of circuits, software and other related information in this document are provided only to illustrate the operation of semiconductor products and application examples. You are fully responsible for the incorporation of these circuits, software, and information in the design of your equipment. Renesas Electronics assumes no responsibility for any losses incurred by you or third parties arising from the use of these circuits, software, or information.
5. When exporting the products or technology described in this document, you should comply with the applicable export control laws and regulations and follow the procedures required by such laws and regulations. You should not use Renesas Electronics products or the technology described in this document for any purpose relating to military applications or use by the military, including but not limited to the development of weapons of mass destruction. Renesas Electronics products and technology may not be used for or incorporated into any products or systems whose manufacture, use, or sale is prohibited under any applicable domestic or foreign laws or regulations.
6. Renesas Electronics has used reasonable care in preparing the information included in this document, but Renesas Electronics does not warrant that such information is error free. Renesas Electronics assumes no liability whatsoever for any damages incurred by you resulting from errors in or omissions from the information included herein.
7. Renesas Electronics products are classified according to the following three quality grades: “Standard”, “High Quality”, and “Specific”. The recommended applications for each Renesas Electronics product depends on the product’s quality grade, as indicated below. You must check the quality grade of each Renesas Electronics product before using it in a particular application. You may not use any Renesas Electronics product for any application categorized as “Specific” without the prior written consent of Renesas Electronics. Further, you may not use any Renesas Electronics product for any application for which it is not intended without the prior written consent of Renesas Electronics. Renesas Electronics shall not be in any way liable for any damages or losses incurred by you or third parties arising from the use of any Renesas Electronics product for an application categorized as “Specific” or for which the product is not intended where you have failed to obtain the prior written consent of Renesas Electronics. The quality grade of each Renesas Electronics product is “Standard” unless otherwise expressly specified in a Renesas Electronics data sheets or data books, etc.
 - “Standard”: Computers; office equipment; communications equipment; test and measurement equipment; audio and visual equipment; home electronic appliances; machine tools; personal electronic equipment; and industrial robots.
 - “High Quality”: Transportation equipment (automobiles, trains, ships, etc.); traffic control systems; anti-disaster systems; anti-crime systems; safety equipment; and medical equipment not specifically designed for life support.
 - “Specific”: Aircraft; aerospace equipment; submersible repeaters; nuclear reactor control systems; medical equipment or systems for life support (e.g. artificial life support devices or systems), surgical implantations, or healthcare intervention (e.g. excision, etc.), and any other applications or purposes that pose a direct threat to human life.
8. You should use the Renesas Electronics products described in this document within the range specified by Renesas Electronics, especially with respect to the maximum rating, operating supply voltage range, movement power voltage range, heat radiation characteristics, installation and other product characteristics. Renesas Electronics shall have no liability for malfunctions or damages arising out of the use of Renesas Electronics products beyond such specified ranges.
9. Although Renesas Electronics endeavors to improve the quality and reliability of its products, semiconductor products have specific characteristics such as the occurrence of failure at a certain rate and malfunctions under certain use conditions. Further, Renesas Electronics products are not subject to radiation resistance design. Please be sure to implement safety measures to guard them against the possibility of physical injury, and injury or damage caused by fire in the event of the failure of a Renesas Electronics product, such as safety design for hardware and software including but not limited to redundancy, fire control and malfunction prevention, appropriate treatment for aging degradation or any other appropriate measures. Because the evaluation of microcomputer software alone is very difficult, please evaluate the safety of the final products or system manufactured by you.
10. Please contact a Renesas Electronics sales office for details as to environmental matters such as the environmental compatibility of each Renesas Electronics product. Please use Renesas Electronics products in compliance with all applicable laws and regulations that regulate the inclusion or use of controlled substances, including without limitation, the EU RoHS Directive. Renesas Electronics assumes no liability for damages or losses occurring as a result of your noncompliance with applicable laws and regulations.
11. This document may not be reproduced or duplicated, in any form, in whole or in part, without prior written consent of Renesas Electronics.
12. Please contact a Renesas Electronics sales office if you have any questions regarding the information contained in this document or Renesas Electronics products, or if you have any other inquiries.

(Note 1) “Renesas Electronics” as used in this document means Renesas Electronics Corporation and also includes its majority-owned subsidiaries.

(Note 2) “Renesas Electronics product(s)” means any product developed or manufactured by or for Renesas Electronics.

1. Overview

1.1 Features

The R8C/2G Group of single-chip MCUs incorporates the R8C/Tiny Series CPU core, employing sophisticated instructions for a high level of efficiency. With 1 Mbyte of address space, and it is capable of executing instructions at high speed. In addition, the CPU core boasts a multiplier for high-speed operation processing.

Power consumption is low, and the supported operating modes allow additional power control. These MCUs also use an anti-noise configuration to reduce emissions of electromagnetic noise and are designed to withstand EMI.

Integration of many peripheral functions, including multifunction timer and serial interface, reduces the number of system components.

1.1.1 Applications

Electric power meters, electronic household appliances, office equipment, audio equipment, consumer equipment, etc.

1.1.2 Specifications

Table 1.1 outlines the Specifications for R8C/2G Group.

Table 1.1 Specifications for R8C/2G Group

Item	Function	Specification
CPU	Central processing unit	R8C/Tiny series core <ul style="list-style-type: none"> • Number of fundamental instructions: 89 • Minimum instruction execution time: <ul style="list-style-type: none"> 125 ns (System clock = 8 MHz, VCC = 2.7 to 5.5 V) 250 ns (System clock = 4 MHz, VCC = 2.2 to 5.5 V) • Multiplier: 16 bits × 16 bits → 32 bits • Multiply-accumulate instruction: 16 bits × 16 bits + 32 bits → 32 bits • Operation mode: Single-chip mode (address space: 1 Mbyte)
Memory	ROM, RAM	Refer to Table 1.2 Product List for R8C/2G Group .
Power Supply Voltage Detection	Voltage detection circuit	<ul style="list-style-type: none"> • Power-on reset • Voltage detection 3
Comparator		<ul style="list-style-type: none"> • 2 circuits (shared with voltage monitor 1 and voltage monitor 2) • External reference voltage input is available
I/O Ports		<ul style="list-style-type: none"> • Output-only: 1 • CMOS I/O ports: 27, selectable pull-up resistor
Clock	Clock generation circuits	<ul style="list-style-type: none"> • 2 circuits: On-chip oscillator (high-speed, low-speed) (high-speed on-chip oscillator has a frequency adjustment function), XCIN clock oscillation circuit (32 kHz) • Frequency divider circuit: Dividing selectable 1, 2, 4, 8, and 16 • Low power consumption modes: <ul style="list-style-type: none"> Standard operating mode (low-speed clock, high-speed on-chip oscillator, low-speed on-chip oscillator), wait mode, stop mode
		Real-time clock (timer RE)
Interrupts		<ul style="list-style-type: none"> • External: 5 sources, Internal: 17 sources, Software: 4 sources • Priority levels: 7 levels
Watchdog Timer		15 bits × 1 (with prescaler), reset start selectable
Timer	Timer RA	8 bits × 1 (with 8-bit prescaler) Timer mode (period timer), pulse output mode (output level inverted every period), event counter mode, pulse width measurement mode, pulse period measurement mode
	Timer RB	8 bits × 1 (with 8-bit prescaler) Timer mode (period timer), programmable waveform generation mode (PWM output), programmable one-shot generation mode, programmable wait one-shot generation mode
	Timer RE	8 bits × 1 Real-time clock mode (count seconds, minutes, hours, days of week), output compare mode
	Timer RF	16 bits × 1 (with capture/compare register pin and compare register pin) Input capture mode, output compare mode
Serial Interface	UART0, UART2	Clock synchronous serial I/O/UART × 2
LIN Module		Hardware LIN: 1 (timer RA, UART0)
Flash Memory		<ul style="list-style-type: none"> • Programming and erasure voltage: VCC = 2.7 to 5.5 V • Programming and erasure endurance: 100 times • Program security: ROM code protect, ID code check • Debug functions: On-chip debug, on-board flash rewrite function
Operating Frequency/Supply Voltage		System clock = 8 MHz (VCC = 2.7 to 5.5 V) System clock = 4 MHz (VCC = 2.2 to 5.5 V)
Current consumption		5 mA (VCC = 5 V, system clock = 8 MHz) 23 μA (VCC = 3 V, wait mode (low-speed on-chip oscillator on)) 0.7 μA (VCC = 3 V, stop mode, BGR trimming circuit disabled)
Operating Ambient Temperature		-20 to 85°C (N version) -40 to 85°C (D version) ⁽¹⁾
Package		32-pin LQFP Package code: PLQP0032GB-A (previous code: 32P6U-A)

NOTE:

1. Specify the D version if D version functions are to be used.

1.2 Product List

Table 1.2 lists Product List for R8C/2G Group, Figure 1.1 shows a Part Number, Memory Size, and Package of R8C/2G Group.

Table 1.2 Product List for R8C/2G Group **Current of Apr. 2008**

Part No.	ROM Capacity	RAM Capacity	Package Type	Remarks
R5F212G4SNFP	16 Kbytes	512 bytes	PLQP0032GB-A	N version
R5F212G5SNFP	24 Kbytes	1 Kbytes	PLQP0032GB-A	
R5F212G6SNFP	32 Kbytes	1 Kbytes	PLQP0032GB-A	
R5F212G4SDFP	16 Kbytes	512 bytes	PLQP0032GB-A	D version
R5F212G5SDFP	24 Kbytes	1 Kbytes	PLQP0032GB-A	
R5F212G6SDFP	32 Kbytes	1 Kbytes	PLQP0032GB-A	

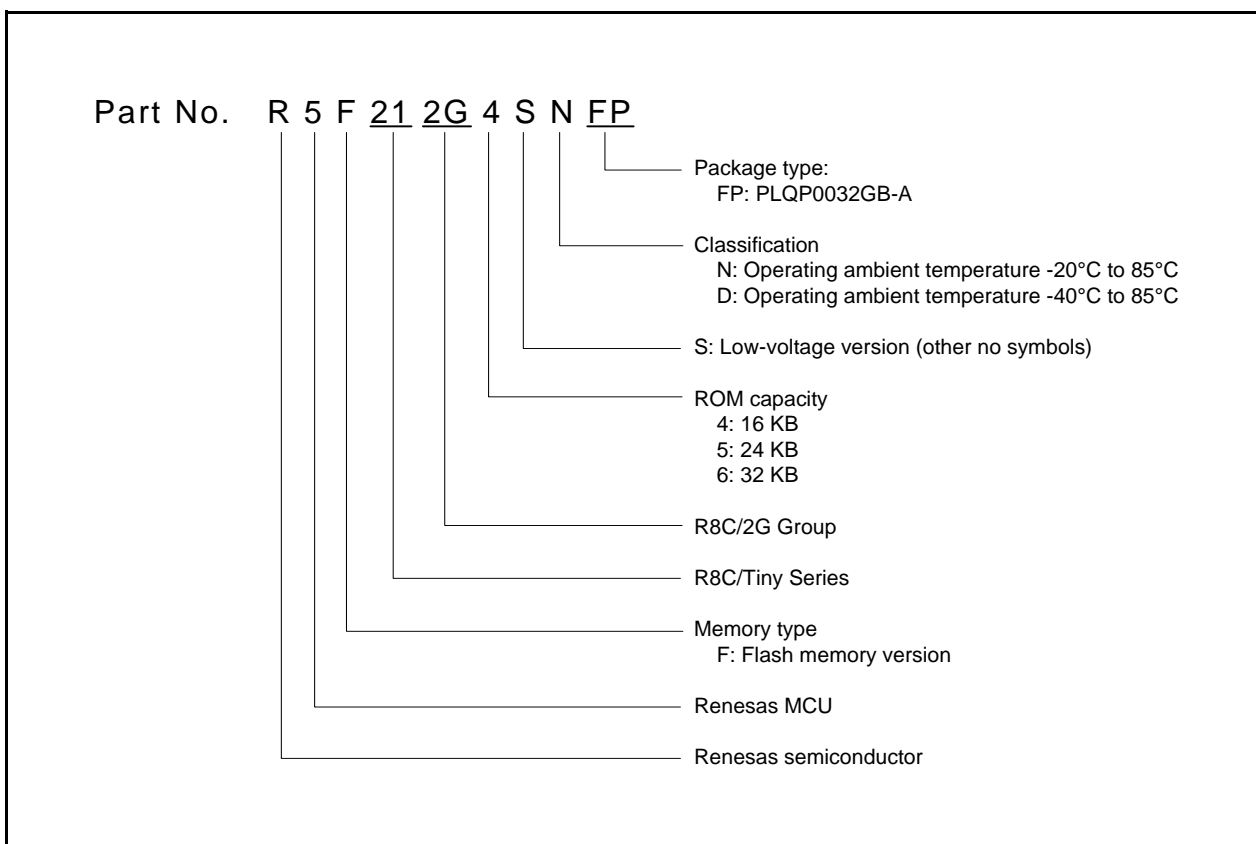

Figure 1.1 Part Number, Memory Size, and Package of R8C/2G Group

1.3 Block Diagram

Figure 1.2 shows a Block Diagram.

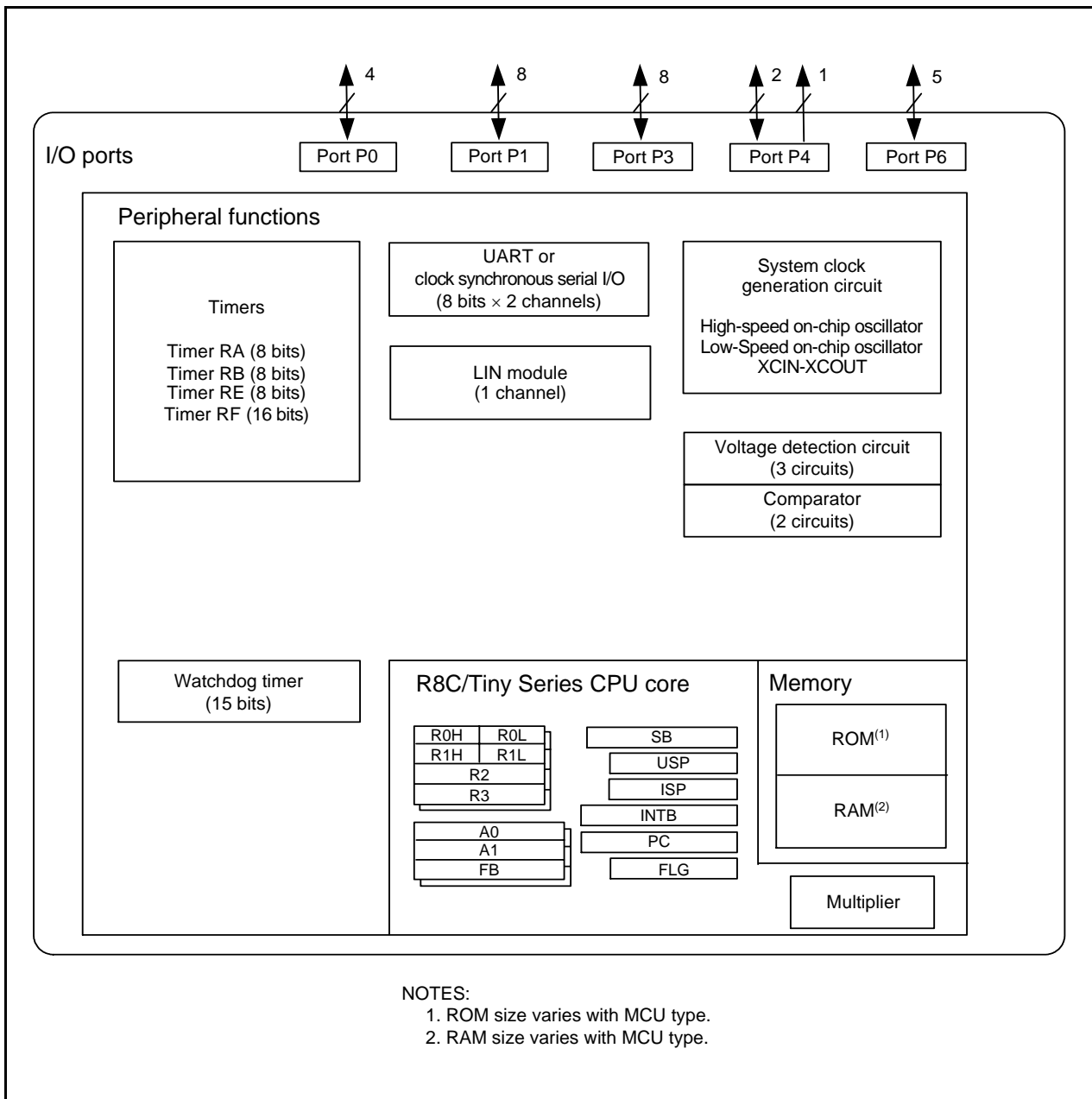

Figure 1.2 Block Diagram

1.4 Pin Assignment

Figure 1.3 shows Pin Assignment (Top View). Table 1.3 outlines the Pin Name Information by Pin Number.

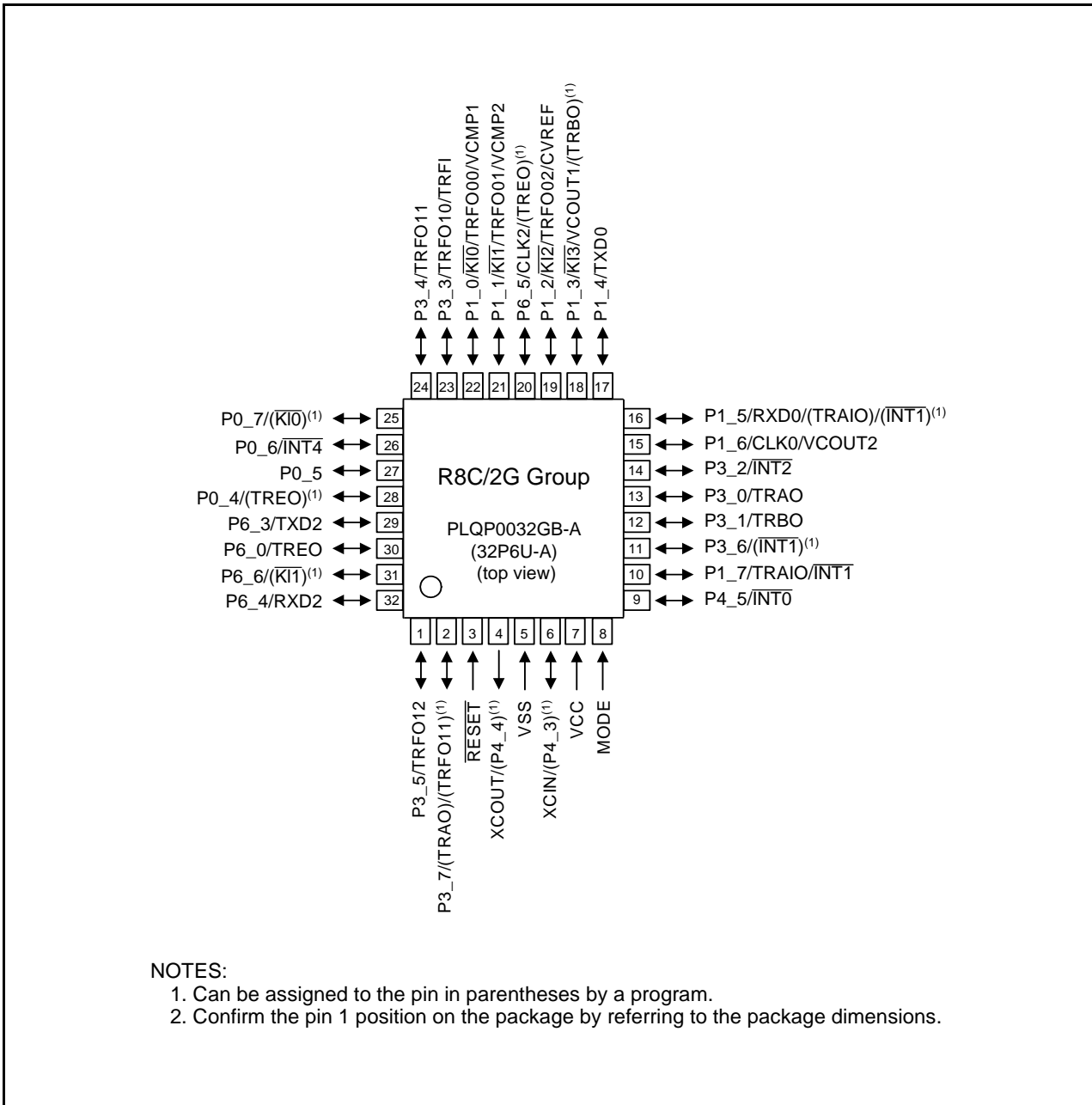

Figure 1.3 Pin Assignment (Top View)

Table 1.3 Pin Name Information by Pin Number

Pin Number	Control Pin	Port	I/O Pin Functions for of Peripheral Modules			
			Interrupt	Timer	Serial Interface	Comparator
1		P3_5		TRFO12		
2		P3_7		(TRAO)/(TRFO11) ⁽¹⁾		
3	RESET					
4	XCOU	(P4_4)				
5	VSS					
6	XCIN	(P4_3)				
7	VCC					
8	MODE					
9		P4_5	INT0			
10		P1_7	INT1	TRAIO		
11		P3_6	(INT1) ⁽¹⁾			
12		P3_1		TRBO		
13		P3_0		TRAO		
14		P3_2	INT2			
15		P1_6			CLK0	VCOUT2
16		P1_5	(INT1) ⁽¹⁾	(TRAIO) ⁽¹⁾	RXD0	
17		P1_4			TXD0	
18		P1_3	KI3	(TRBO) ⁽¹⁾		VCOUT1
19		P1_2	KI2	TRFO02		CVREF
20		P6_5		(TREQ) ⁽¹⁾	CLK2	
21		P1_1	KI1	TRFO01		VCMP2
22		P1_0	KI0	TRFO00		VCMP1
23		P3_3		TRFO10/TRFI		
24		P3_4		TRFO11		
25		P0_7	(KI0) ⁽¹⁾			
26		P0_6	INT4			
27		P0_5				
28		P0_4		(TREQ) ⁽¹⁾		
29		P6_3			TXD2	
30		P6_0		TREQ		
31		P6_6	(KI1) ⁽¹⁾			
32		P6_4			RXD2	

NOTE:

1. Can be assigned to the pin in parentheses by a program.

1.5 Pin Functions

Table 1.4 lists Pin Functions.

Table 1.4 Pin Functions

Type	Symbol	I/O Type	Description
Power supply input	VCC, VSS	–	Apply 2.2 V to 5.5 V to the VCC pin. Apply 0 V to the VSS pin.
Reset input	$\overline{\text{RESET}}$	I	Input “L” on this pin resets the MCU.
MODE	MODE	I	Connect this pin to VCC via a resistor.
XCIN clock input	XCIN	I	These pins are provided for XCIN clock generation circuit I/O. Connect a crystal oscillator between the XCIN and XCOU pins. ⁽¹⁾ To use an external clock, input it to the XCIN pin and leave the XCOU pin open.
XCIN clock output	XCOU	O	
$\overline{\text{INT}}$ interrupt input	$\overline{\text{INT0}}$ to $\overline{\text{INT2}}$, $\overline{\text{INT4}}$	I	$\overline{\text{INT}}$ interrupt input pins
Key input interrupt	$\overline{\text{KI0}}$ to $\overline{\text{KI3}}$	I	Key input interrupt input pins
Timer RA	TRAIO	I/O	Timer RA I/O pin
	TRAO	O	Timer RA output pin
Timer RB	TRBO	O	Timer RB output pin
Timer RE	TREO	O	Divided clock output pin
Timer RF	TRFI	I	Timer RF input pin
	TRFO00 to TRFO02, TRFO10 to TRFO12	O	Timer RF output pins
Serial interface	CLK0, CLK2	I/O	Clock I/O pin
	RXD0, RXD2	I	Serial data input pin
	TXD0, TXD2	O	Serial data output pin
Comparator	VCMP1, VCMP2	I	Analog input pins to comparator
	CVREF	I	Reference voltage input pin to comparator
	VCOUT1, VCOUT2	O	Comparator output pins
I/O port	P0_4 to P0_7, P1_0 to P1_7, P3_0 to P3_7, P4_3, P4_5, P6_0, P6_3 to P6_6	I/O	CMOS I/O ports. Each port has an I/O select direction register, allowing each pin in the port to be directed for input or output individually. Any port set to input can be set to use a pull-up resistor or not by a program.
Output port	P4_4	O	Output-only port

I: Input O: Output I/O: Input and output

NOTE:

1. Refer to the oscillator manufacturer for oscillation characteristics.

2. Central Processing Unit (CPU)

Figure 2.1 shows the CPU Registers. The CPU contains 13 registers. R0, R1, R2, R3, A0, A1, and FB configure a register bank. There are two sets of register bank.

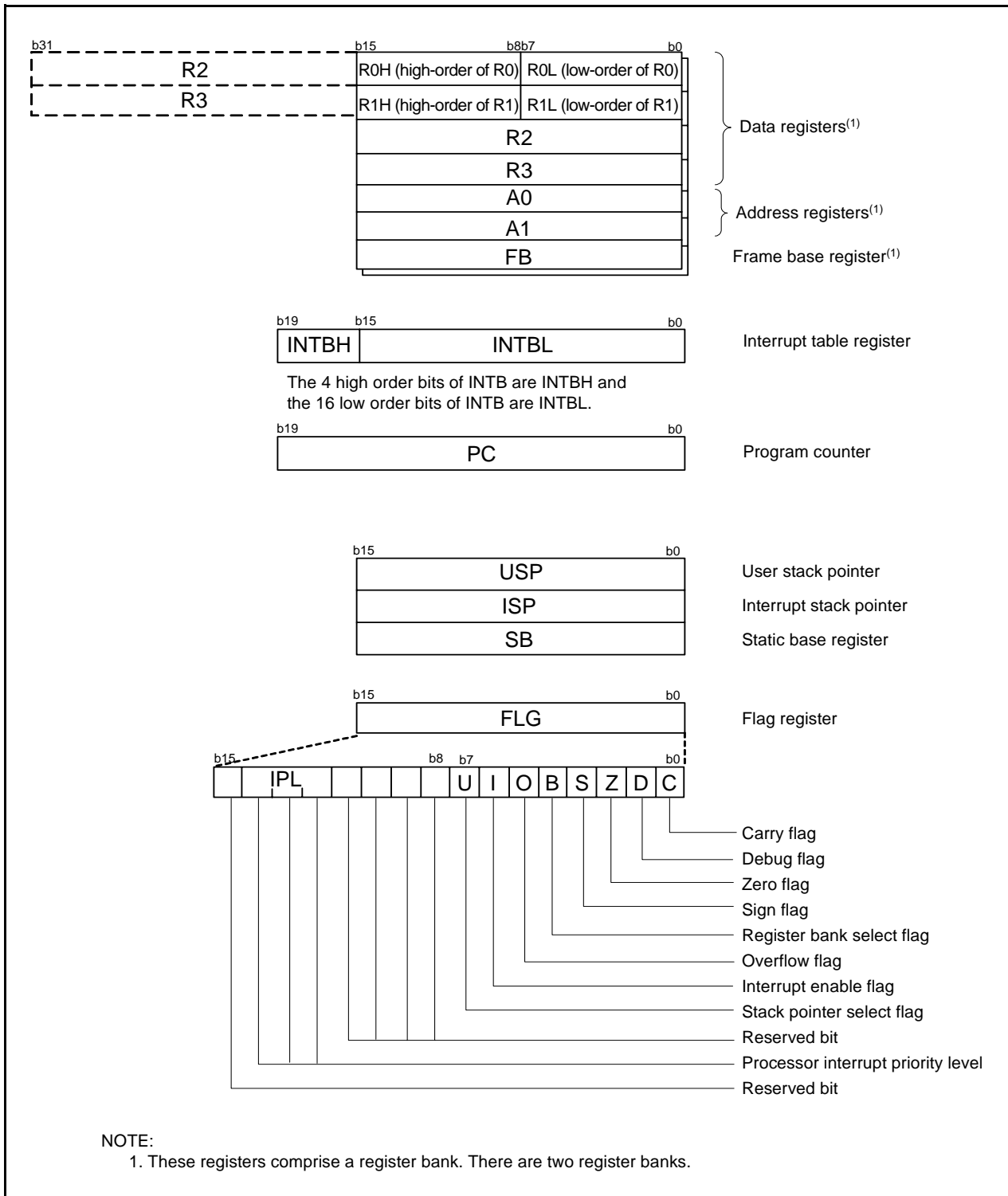

Figure 2.1 CPU Registers

2.1 Data Registers (R0, R1, R2, and R3)

R0 is a 16-bit register for transfer, arithmetic, and logic operations. The same applies to R1 to R3. R0 can be split into high-order bits (R0H) and low-order bits (R0L) to be used separately as 8-bit data registers. R1H and R1L are analogous to R0H and R0L. R2 can be combined with R0 and used as a 32-bit data register (R2R0). R3R1 is analogous to R2R0.

2.2 Address Registers (A0 and A1)

A0 is a 16-bit register for address register indirect addressing and address register relative addressing. It is also used for transfer, arithmetic, and logic operations. A1 is analogous to A0. A1 can be combined with A0 to be used as a 32-bit address register (A1A0).

2.3 Frame Base Register (FB)

FB is a 16-bit register for FB relative addressing.

2.4 Interrupt Table Register (INTB)

INTB is a 20-bit register that indicates the start address of an interrupt vector table.

2.5 Program Counter (PC)

PC is 20 bits wide and indicates the address of the next instruction to be executed.

2.6 User Stack Pointer (USP) and Interrupt Stack Pointer (ISP)

The stack pointers (SP), USP, and ISP, are each 16 bits wide. The U flag of FLG is used to switch between USP and ISP.

2.7 Static Base Register (SB)

SB is a 16-bit register for SB relative addressing.

2.8 Flag Register (FLG)

FLG is an 11-bit register indicating the CPU state.

2.8.1 Carry Flag (C)

The C flag retains carry, borrow, or shift-out bits that have been generated by the arithmetic and logic unit.

2.8.2 Debug Flag (D)

The D flag is for debugging only. Set it to 0.

2.8.3 Zero Flag (Z)

The Z flag is set to 1 when an arithmetic operation results in 0; otherwise to 0.

2.8.4 Sign Flag (S)

The S flag is set to 1 when an arithmetic operation results in a negative value; otherwise to 0.

2.8.5 Register Bank Select Flag (B)

Register bank 0 is selected when the B flag is 0. Register bank 1 is selected when this flag is set to 1.

2.8.6 Overflow Flag (O)

The O flag is set to 1 when an operation results in an overflow; otherwise to 0.

2.8.7 Interrupt Enable Flag (I)

The I flag enables maskable interrupts.

Interrupt are disabled when the I flag is set to 0, and are enabled when the I flag is set to 1. The I flag is set to 0 when an interrupt request is acknowledged.

2.8.8 Stack Pointer Select Flag (U)

ISP is selected when the U flag is set to 0; USP is selected when the U flag is set to 1.

The U flag is set to 0 when a hardware interrupt request is acknowledged or the INT instruction of software interrupt numbers 0 to 31 is executed.

2.8.9 Processor Interrupt Priority Level (IPL)

IPL is 3 bits wide and assigns processor interrupt priority levels from level 0 to level 7.

If a requested interrupt has higher priority than IPL, the interrupt is enabled.

2.8.10 Reserved Bit

If necessary, set to 0. When read, the content is undefined.

3. Memory

Figure 3.1 is a Memory Map of R8C/2G Group. The R8C/2G group has 1 Mbyte of address space from addresses 00000h to FFFFFh.

The internal ROM is allocated lower addresses, beginning with address 0FFFFh. For example, a 16-Kbyte internal ROM area is allocated addresses 0C000h to 0FFFFh.

The fixed interrupt vector table is allocated addresses 0FFDCh to 0FFFFh. They store the starting address of each interrupt routine.

The internal RAM is allocated higher addresses beginning with address 00400h. For example, a 1-Kbyte internal RAM area is allocated addresses 00400h to 007FFh. The internal RAM is used not only for storing data but also for calling subroutines and as stacks when interrupt requests are acknowledged.

Special function registers (SFRs) are allocated addresses 00000h to 002FFh. The peripheral function control registers are allocated here. All addresses within the SFR, which have nothing allocated are reserved for future use and cannot be accessed by users.

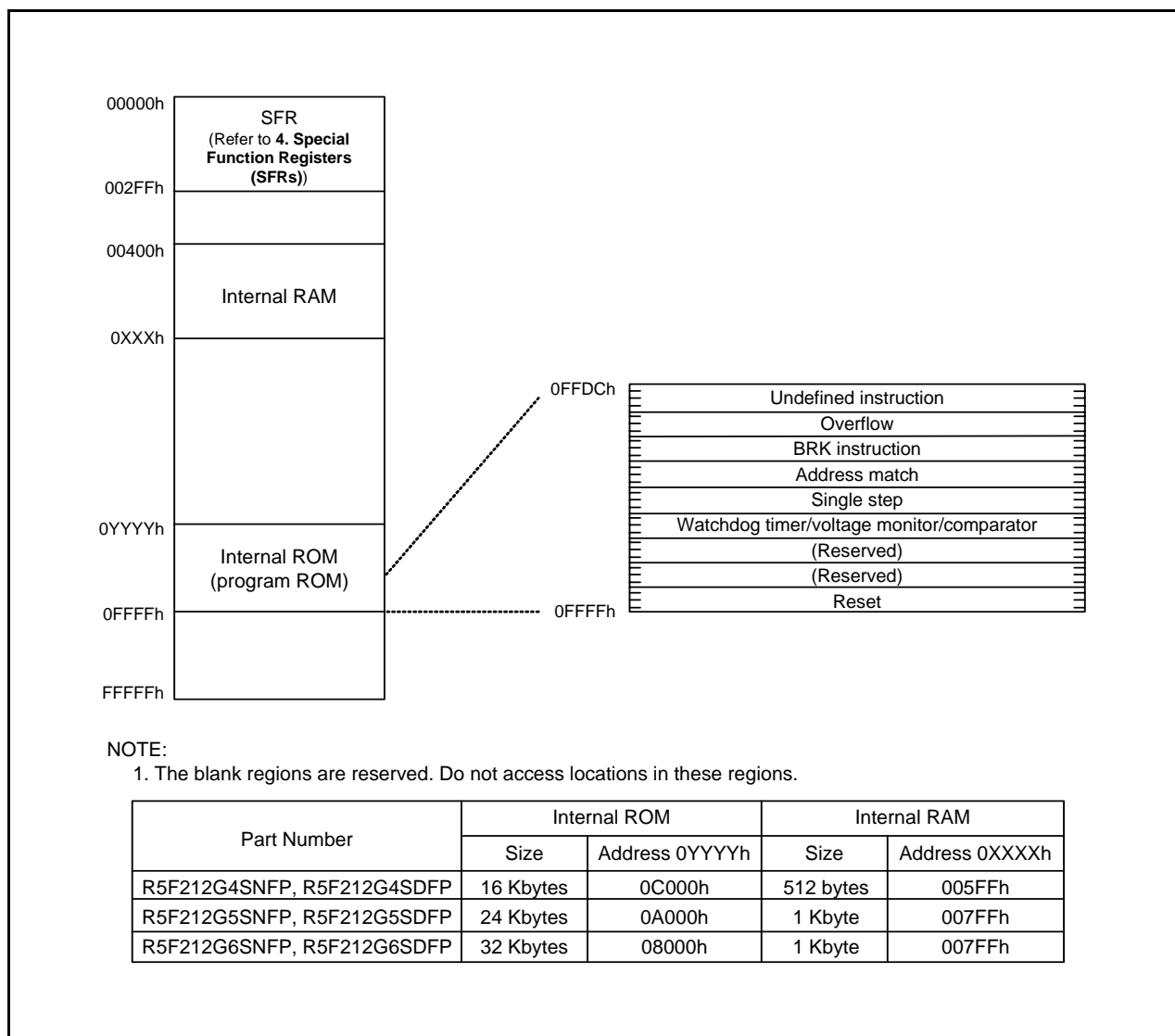

Figure 3.1 Memory Map of R8C/2G Group

4. Special Function Registers (SFRs)

An SFR (special function register) is a control register for a peripheral function. Tables 4.1 to 4.12 list the special function registers.

Table 4.1 SFR Information (1)(1)

Address	Register	Symbol	After reset
0000h			
0001h			
0002h			
0003h			
0004h	Processor Mode Register 0	PM0	00h
0005h	Processor Mode Register 1	PM1	00h
0006h	System Clock Control Register 0	CM0	01011000b
0007h	System Clock Control Register 1	CM1	00h
0008h			
0009h			
000Ah	Protect Register	PRCR	00h
000Bh			
000Ch	System Clock Select Register	OCD	00000100b
000Dh	Watchdog Timer Reset Register	WDTR	XXh
000Eh	Watchdog Timer Start Register	WDTS	XXh
000Fh	Watchdog Timer Control Register	WDC	00X11111b
0010h	Address Match Interrupt Register 0	RMAD0	00h
0011h			00h
0012h			00h
0013h	Address Match Interrupt Enable Register	AIER	00h
0014h	Address Match Interrupt Register 1	RMAD1	00h
0015h			00h
0016h			00h
0017h			
0018h			
0019h			
001Ah			
001Bh			
001Ch	Count Source Protection Mode Register	CSPR	00h 10000000b(2)
001Dh			
001Eh			
001Fh			
0020h	High-Speed On-Chip Oscillator Control Register 0	HRA0	00h
0021h	High-Speed On-Chip Oscillator Control Register 1	HRA1	When Shipping
0022h	High-Speed On-Chip Oscillator Control Register 2	HRA2	00h
0023h			
0024h			
0025h			
0026h			
0027h			
0028h	Clock Prescaler Reset Flag	CPSRF	00h
0029h	High-Speed On-Chip Oscillator Control Register 4	FRA4	When Shipping
002Ah			
002Bh	High-Speed On-Chip Oscillator Control Register 6	FRA6	When Shipping
002Ch			
002Dh			
002Eh	BGR Trimming Auxiliary Register A	BGRTRMA	When Shipping
002Fh	BGR Trimming Auxiliary Register B	BGRTRMB	When Shipping

X: Undefined

NOTES:

1. The blank regions are reserved. Do not access locations in these regions.
2. The CSPROINI bit in the OFS register is set to 0.

Table 4.2 SFR Information (2)(1)

Address	Register	Symbol	After reset
0030h			
0031h	Voltage Detection Register 1(2)	VCA1	00001000b
0032h	Voltage Detection Register 2(2)	VCA2	00h(3) 00100000b(4)
0033h			
0034h			
0035h			
0036h	Voltage Monitor 1 Circuit Control Register(5)	VW1C	00001010b
0037h	Voltage Monitor 2 Circuit Control Register(5)	VW2C	00000010b
0038h	Voltage Monitor 0 Circuit Control Register(2)	VW0C	1000X010b(3) 1100X011b(4)
0039h			
003Ah			
003Bh	Voltage Detection Circuit External Input Control Register	VCAB	00h
003Ch	Comparator Mode Register	ALCMR	00h
003Dh	Voltage Monitor Circuit Edge Select Register	VCAC	00h
003Eh	BGR Control Register	BGRCR	00h
003Fh	BGR Trimming Register	BGRTRM	When Shipping
0040h			
0041h	Comparator 1 Interrupt Control Register	VCMP1IC	XXXXX000b
0042h	Comparator 2 Interrupt Control Register	VCMP2IC	XXXXX000b
0043h			
0044h			
0045h			
0046h			
0047h			
0048h			
0049h			
004Ah	Timer RE Interrupt Control Register	TREIC	XXXXX000b
004Bh	UART2 Transmit Interrupt Control Register	S2TIC	XXXXX000b
004Ch	UART2 Receive Interrupt Control Register	S2RIC	XXXXX000b
004Dh	Key Input Interrupt Control Register	KUPIC	XXXXX000b
004Eh			
004Fh			
0050h	Compare 1 Interrupt Control Register	CMP1IC	XXXXX000b
0051h	UART0 Transmit Interrupt Control Register	S0TIC	XXXXX000b
0052h	UART0 Receive Interrupt Control Register	S0RIC	XXXXX000b
0053h			
0054h			
0055h	INT2 Interrupt Control Register	INT2IC	XX00X000b
0056h	Timer RA Interrupt Control Register	TRAIC	XXXXX000b
0057h			
0058h	Timer RB Interrupt Control Register	TRBIC	XXXXX000b
0059h	INT1 Interrupt Control Register	INT1IC	XX00X000b
005Ah			
005Bh	Timer RF Interrupt Control Register	TRFIC	XXXXX000b
005Ch	Compare 0 Interrupt Control Register	CMP0IC	XXXXX000b
005Dh	INT0 Interrupt Control Register	INT0IC	XX00X000b
005Eh	INT4 Interrupt Control Register	INT4IC	XX00X000b
005Fh	Capture Interrupt Control Register	CAPIC	XXXXX000b
0060h			
0061h			
0062h			
0063h			
0064h			
0065h			
0066h			
0067h			
0068h			
0069h			
006Ah			
006Bh			
006Ch			
006Dh			
006Eh			
006Fh			

X: Undefined
NOTES:

1. The blank regions are reserved. Do not access locations in these regions.
2. Software reset, watchdog timer reset, voltage monitor 1 reset, or voltage monitor 2 reset do not affect this register.
3. The LVD0ON bit in the OFS register is set to 1 and hardware reset.
4. Power-on reset, voltage monitor 0 reset, or the LVD0ON bit in the OFS register is set to 0 and hardware reset.
5. Software reset, watchdog timer reset, voltage monitor 1 reset, or voltage monitor 2 reset do not affect b2 and b3.

Table 4.3 SFR Information (3)(1)

Address	Register	Symbol	After reset
0070h			
0071h			
0072h			
0073h			
0074h			
0075h			
0076h			
0077h			
0078h			
0079h			
007Ah			
007Bh			
007Ch			
007Dh			
007Eh			
007Fh			
0080h			
0081h			
0082h			
0083h			
0084h			
0085h			
0086h			
0087h			
0088h			
0089h			
008Ah			
008Bh			
008Ch			
008Dh			
008Eh			
008Fh			
0090h			
0091h			
0092h			
0093h			
0094h			
0095h			
0096h			
0097h			
0098h			
0099h			
009Ah			
009Bh			
009Ch			
009Dh			
009Eh			
009Fh			
00A0h	UART0 Transmit/Receive Mode Register	U0MR	00h
00A1h	UART0 Bit Rate Register	U0BRG	XXh
00A2h	UART0 Transmit Buffer Register	U0TB	XXh
00A3h			XXh
00A4h	UART0 Transmit/Receive Control Register 0	U0C0	00001000b
00A5h	UART0 Transmit/Receive Control Register 1	U0C1	00000010b
00A6h	UART0 Receive Buffer Register	U0RB	XXh
00A7h			XXh
00A8h			
00A9h			
00AAh			
00ABh			
00ACh			
00ADh			
00AEh			
00AFh			

X: Undefined

NOTE:

1. The blank regions are reserved. Do not access locations in these regions.

Table 4.4 SFR Information (4)⁽¹⁾

Address	Register	Symbol	After reset
00B0h			
00B1h			
00B2h			
00B3h			
00B4h			
00B5h			
00B6h			
00B7h			
00B8h			
00B9h			
00BAh			
00BBh			
00BCh			
00BDh			
00BEh			
00BFh			
00C0h			
00C1h			
00C2h			
00C3h			
00C4h			
00C5h			
00C6h			
00C7h			
00C8h			
00C9h			
00CAh			
00CBh			
00CCh			
00CDh			
00CEh			
00CFh			
00D0h			
00D1h			
00D2h			
00D3h			
00D4h			
00D5h			
00D6h			
00D7h			
00D8h			
00D9h			
00DAh			
00DBh			
00DCh			
00DDh			
00DEh			
00DFh			
00E0h	Port P0 Register	P0	00h
00E1h	Port P1 Register	P1	00h
00E2h	Port P0 Direction Register	PD0	00h
00E3h	Port P1 Direction Register	PD1	00h
00E4h			
00E5h	Port P3 Register	P3	00h
00E6h			
00E7h	Port P3 Direction Register	PD3	00h
00E8h	Port P4 Register	P4	00h
00E9h			
00EAh	Port P4 Direction Register	PD4	00h
00EBh			
00ECh	Port P6 Register	P6	00h
00EDh			
00EEh	Port P6 Direction Register	PD6	00h
00EFh			

X: Undefined

NOTE:

1. The blank regions are reserved. Do not access locations in these regions.

Table 4.5 SFR Information (5)(1)

Address	Register	Symbol	After reset
00F0h			
00F1h			
00F2h			
00F3h			
00F4h			
00F5h			
00F6h	Pin Select Register 2	PINSR2	00h
00F7h	Pin Select Register 3	PINSR3	00h
00F8h	Port Mode Register	PMR	00h
00F9h	External Input Enable Register	INTEN	00h
00FAh	INT Input Filter Select Register	INTF	00h
00FBh	Key Input Enable Register	KIEN	00h
00FCh	Pull-Up Control Register 0	PUR0	00h
00FDh	Pull-Up Control Register 1	PUR1	00h
00FEh			
00FFh			
0100h	Timer RA Control Register	TRACR	00h
0101h	Timer RA I/O Control Register	TRAIOC	00h
0102h	Timer RA Mode Register	TRAMR	00h
0103h	Timer RA Prescaler Register	TRAPRE	FFh
0104h	Timer RA Register	TRA	FFh
0105h			
0106h	LIN Control Register	LINCR	00h
0107h	LIN Status Register	LINST	00h
0108h	Timer RB Control Register	TRBCR	00h
0109h	Timer RB One-Shot Control Register	TRBOCR	00h
010Ah	Timer RB I/O Control Register	TRBIOC	00h
010Bh	Timer RB Mode Register	TRBMR	00h
010Ch	Timer RB Prescaler Register	TRBPRE	FFh
010Dh	Timer RB Secondary Register	TRBSC	FFh
010Eh	Timer RB Primary Register	TRBPR	FFh
010Fh			
0110h			
0111h			
0112h			
0113h			
0114h			
0115h			
0116h			
0117h			
0118h	Timer RE Second Data Register / Counter Data Register	TRESEC	XXh
0119h	Timer RE Minute Data Register / Compare Data Register	TREMIN	XXh
011Ah	Timer RE Hour Data Register	TREHR	X0XXXXXXb
011Bh	Timer RE Day of Week Data Register	TREWK	X0000XXXb
011Ch	Timer RE Control Register 1	TRECR1	XXX0X0X0b
011Dh	Timer RE Control Register 2	TRECR2	00XXXXXXb
011Eh	Timer RE Count Source Select Register	TRECSR	00001000b
011Fh	Timer RE Real-Time Clock Precision Adjust Register	TREOPR	00h
0120h			
0121h			
0122h			
0123h			
0124h			
0125h			
0126h			
0127h			
0128h			
0129h			
012Ah			
012Bh			
012Ch			
012Dh			
012Eh			
012Fh			

X: Undefined

NOTE:

1. The blank regions are reserved. Do not access locations in these regions.

Table 4.6 SFR Information (6)(1)

Address	Register	Symbol	After reset
0130h			
0131h			
0132h			
0133h			
0134h			
0135h			
0136h			
0137h			
0138h			
0139h			
013Ah			
013Bh			
013Ch			
013Dh			
013Eh			
013Fh			
0140h			
0141h			
0142h			
0143h			
0144h			
0145h			
0146h			
0147h			
0148h			
0149h			
014Ah			
014Bh			
014Ch			
014Dh			
014Eh			
014Fh			
0150h			
0151h			
0152h			
0153h			
0154h			
0155h			
0156h			
0157h			
0158h			
0159h			
015Ah			
015Bh			
015Ch			
015Dh			
015Eh			
015Fh			
0160h	UART2 Transmit/Receive Mode Register	U2MR	00h
0161h	UART2 Bit Rate Register	U2BRG	XXh
0162h	UART2 Transmit Buffer Register	U2TB	XXh
0163h			XXh
0164h	UART2 Transmit/Receive Control Register 0	U2C0	00001000b
0165h	UART2 Transmit/Receive Control Register 1	U2C1	00000010b
0166h	UART2 Receive Buffer Register	U2RB	XXh
0167h			XXh
0168h			
0169h			
016Ah			
016Bh			
016Ch			
016Dh			
016Eh			
016Fh			

X: Undefined

NOTE:

1. The blank regions are reserved. Do not access locations in these regions.

Table 4.7 SFR Information (7)(1)

Address	Register	Symbol	After reset
0170h			
0171h			
0172h			
0173h			
0174h			
0175h			
0176h			
0177h			
0178h			
0179h			
017Ah			
017Bh			
017Ch			
017Dh			
017Eh			
017Fh			
0180h			
0181h			
0182h			
0183h			
0184h			
0185h			
0186h			
0187h			
0188h			
0189h			
018Ah			
018Bh			
018Ch			
018Dh			
018Eh			
018Fh			
0190h			
0191h			
0192h			
0193h			
0194h			
0195h			
0196h			
0197h			
0198h			
0199h			
019Ah			
019Bh			
019Ch			
019Dh			
019Eh			
019Fh			
01A0h			
01A1h			
01A2h			
01A3h			
01A4h			
01A5h			
01A6h			
01A7h			
01A8h			
01A9h			
01AAh			
01ABh			
01ACh			
01ADh			
01AEh			
01AFh			

X: Undefined

NOTE:

1. The blank regions are reserved. Do not access locations in these regions.

Table 4.8 SFR Information (8)(1)

Address	Register	Symbol	After reset
01B0h			
01B1h			
01B2h			
01B3h	Flash Memory Control Register 4	FMR4	01000000b
01B4h			
01B5h	Flash Memory Control Register 1	FMR1	1000000Xb
01B6h			
01B7h	Flash Memory Control Register 0	FMR0	00000001b
01B8h			
01B9h			
01BAh			
01BBh			
01BCh			
01BDh			
01BEh			
01BFh			
01C0h			
01C1h			
01C2h			
01C3h			
01C4h			
01C5h			
01C6h			
01C7h			
01C8h			
01C9h			
01CAh			
01CBh			
01CCh			
01CDh			
01CEh			
01CFh			
01D0h			
01D1h			
01D2h			
01D3h			
01D4h			
01D5h			
01D6h			
01D7h			
01D8h			
01D9h			
01DAh			
01DBh			
01DCh			
01DDh			
01DEh			
01DFh			
01E0h			
01E1h			
01E2h			
01E3h			
01E4h			
01E5h			
01E6h			
01E7h			
01E8h			
01E9h			
01EAh			
01EBh			
01ECh			
01EDh			
01EEh			
01EFh			

X: Undefined

NOTE:

1. The blank regions are reserved. Do not access locations in these regions.

Table 4.9 SFR Information (9)⁽¹⁾

Address	Register	Symbol	After reset
01F0h			
01F1h			
01F2h			
01F3h			
01F4h			
01F5h			
01F6h			
01F7h			
01F8h			
01F9h			
01FAh			
01FBh			
01FCh			
01FDh			
01FEh			
01FFh			
0200h			
0201h			
0202h			
0203h			
0204h			
0205h			
0206h			
0207h			
0208h			
0209h			
020Ah			
020Bh			
020Ch			
020Dh			
020Eh			
020Fh			
0210h			
0211h			
0212h			
0213h			
0214h			
0215h			
0216h			
0217h			
0218h			
0219h			
021Ah			
021Bh			
021Ch			
021Dh			
021Eh			
021Fh			
0220h			
0221h			
0222h			
0223h			
0224h			
0225h			
0226h			
0227h			
0228h			
0229h			
022Ah			
022Bh			
022Ch			
022Dh			
022Eh			
022Fh			

X: Undefined

NOTE:

1. The blank regions are reserved. Do not access locations in these regions.

Table 4.10 SFR Information (10)(1)

Address	Register	Symbol	After reset
0230h			
0231h			
0232h			
0233h			
0234h			
0235h			
0236h			
0237h			
0238h			
0239h			
023Ah			
023Bh			
023Ch			
023Dh			
023Eh			
023Fh			
0240h			
0241h			
0242h			
0243h			
0244h			
0245h			
0246h			
0247h			
0248h			
0249h			
024Ah			
024Bh			
024Ch			
024Dh			
024Eh			
024Fh			
0250h			
0251h			
0252h			
0253h			
0254h			
0255h			
0256h			
0257h			
0258h			
0259h			
025Ah			
025Bh			
025Ch			
025Dh			
025Eh			
025Fh			
0260h			
0261h			
0262h			
0263h			
0264h			
0265h			
0266h			
0267h			
0268h			
0269h			
026Ah			
026Bh			
026Ch			
026Dh			
026Eh			
026Fh			

X: Undefined

NOTE:

1. The blank regions are reserved. Do not access locations in these regions.

Table 4.11 SFR Information (11)(1)

Address	Register	Symbol	After reset
0270h			
0271h			
0272h			
0273h			
0274h			
0275h			
0276h			
0277h			
0278h			
0279h			
027Ah			
027Bh			
027Ch			
027Dh			
027Eh			
027Fh			
0280h			
0281h			
0282h			
0283h			
0284h			
0285h			
0286h			
0287h			
0288h			
0289h			
028Ah			
028Bh			
028Ch			
028Dh			
028Eh			
028Fh			
0290h	Timer RF Register	TRF	00h
0291h			00h
0292h			
0293h			
0294h			
0295h			
0296h			
0297h			
0298h			
0299h	Timer RF Control Register 2	TRFCR2	00h
029Ah	Timer RF Control Register 0	TRFCR0	00h
029Bh	Timer RF Control Register 1	TRFCR1	00h
029Ch	Capture and Compare 0 Register	TRFM0	0000h ⁽²⁾
029Dh			FFFFh ⁽³⁾
029Eh	Compare 1 Register	TRFM1	FFh
029Fh			FFh
02A0h			
02A1h			
02A2h			
02A3h			
02A4h			
02A5h			
02A6h			
02A7h			
02A8h			
02A9h			
02AAh			
02ABh			
02ACh			
02ADh			
02AEh			
02AFh			

X: Undefined

NOTES:

1. The blank regions are reserved. Do not access locations in these regions.
2. After input capture mode.
3. After output compare mode.

Table 4.12 SFR Information (12)(1)

Address	Register	Symbol	After reset
02B0h			
02B1h			
02B2h			
02B3h			
02B4h			
02B5h			
02B6h			
02B7h			
02B8h			
02B9h			
02BAh			
02BBh			
02BCh			
02BDh			
02BEh			
02BFh			
02C0h			
02C1h			
02C2h			
02C3h			
02C4h			
02C5h			
02C6h			
02C7h			
02C8h			
02C9h			
02CAh			
02CBh			
02CCh			
02CDh			
02CEh			
02CFh			
02D0h			
02D1h			
02D2h			
02D3h			
02D4h			
02D5h			
02D6h			
02D7h			
02D8h			
02D9h			
02DAh			
02DBh			
02DCh			
02DDh			
02DEh			
02DFh			
02E0h			
02EFh			
02F0h			
02F1h			
02F2h			
02F3h			
02F4h			
02F5h			
02F6h			
02F7h			
02F8h			
02F9h			
02FAh			
02FBh	Pin Select Register 4	PINSR4	00h
02FCh			
02FDh	External Input Enable Register 2	INTEN2	00h
02FEh	INT Input Filter Select Register 2	INTF2	00h
02FFh	Timer RF Output Control Register	TRFOUT	00h
FFFh	Option Function Select Register	OFS	(Note 2)

X: Undefined

NOTES:

1. The blank regions are reserved. Do not access locations in these regions.
2. The OFS register cannot be changed by a program. Use a flash programmer to write to it.

5. Electrical Characteristics

Table 5.1 Absolute Maximum Ratings

Symbol	Parameter	Condition	Rated Value	Unit
V _{CC}	Supply voltage		-0.3 to 6.5	V
V _I	Input voltage		-0.3 to V _{CC} + 0.3	V
V _O	Output voltage		-0.3 to V _{CC} + 0.3	V
P _d	Power dissipation	T _{opr} = 25°C	500	mW
T _{opr}	Operating ambient temperature		-20 to 85 (N version) / -40 to 85 (D version)	°C
T _{stg}	Storage temperature		-65 to 150	°C

Table 5.2 Recommended Operating Conditions

Symbol	Parameter		Conditions	Standard			Unit
				Min.	Typ.	Max.	
V _{CC}	Supply voltage			2.2	-	5.5	V
V _{SS}	Supply voltage			-	0	-	V
V _{IH}	Input "H" voltage			0.8 V _{CC}	-	V _{CC}	V
V _{IL}	Input "L" voltage			0	-	0.2 V _{CC}	V
I _{OH(sum)}	Peak sum output "H" current	Sum of all pins I _{OH(peak)}		-	-	-160	mA
I _{OH(sum)}	Average sum output "H" current	Sum of all pins I _{OH(avg)}		-	-	-80	mA
I _{OH(peak)}	Peak output "H" current	All pins		-	-	-10	mA
I _{OH(avg)}	Average output "H" current	All pins		-	-	-5	mA
I _{OL(sum)}	Peak sum output "L" currents	Sum of all pins I _{OL(peak)}		-	-	160	mA
I _{OL(sum)}	Average sum output "L" currents	Sum of all pins I _{OL(avg)}		-	-	80	mA
I _{OL(peak)}	Peak output "L" currents	All pins		-	-	10	mA
I _{OL(avg)}	Average output "L" current	All pins		-	-	5	mA
f _(XCIN)	XCIN clock input oscillation frequency		2.2 V ≤ V _{CC} ≤ 5.5 V	0	-	70	kHz
-	System clock	OCD2 = 0 XCIN clock selected	2.2 V ≤ V _{CC} ≤ 5.5 V	0	-	70	kHz
-		OCD2 = 1 On-chip oscillator clock selected	HRA01 = 0 Low-speed on-chip oscillator selected	-	125	-	kHz
-			HRA01 = 1 High-speed on-chip oscillator selected 2.7 V ≤ V _{CC} ≤ 5.5 V	-	-	8	MHz
-			HRA01 = 1 High-speed on-chip oscillator selected 2.2 V ≤ V _{CC} ≤ 5.5 V	-	-	4	MHz

NOTES:

- V_{CC} = 2.2 to 5.5 V at T_{opr} = -20 to 85°C (N version) / -40 to 85°C (D version), unless otherwise specified.
- The average output current indicates the average value of current measured during 100 ms.

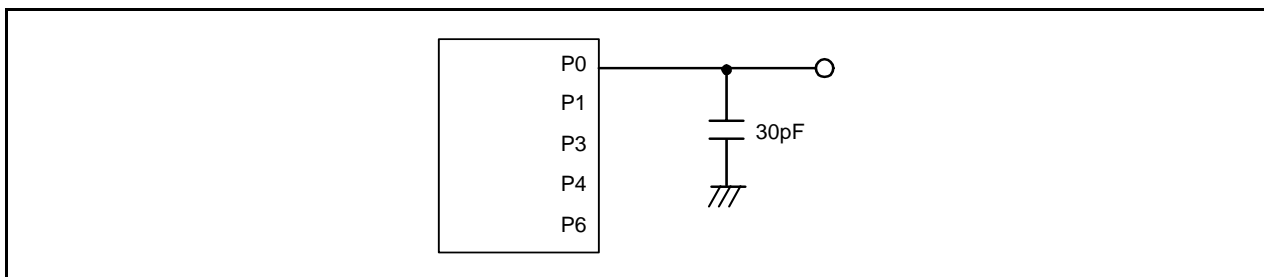

Figure 5.1 Ports P0, P1, P3, P4, and P6 Timing Measurement Circuit

Table 5.3 Flash Memory (Program ROM) Electrical Characteristics

Symbol	Parameter	Conditions	Standard			Unit
			Min.	Typ.	Max.	
–	Program/erase endurance ⁽²⁾		100 ⁽³⁾	–	–	times
–	Byte program time		–	50	400	μs
–	Block erase time		–	0.4	9	s
–	Program, erase voltage		2.7	–	5.5	V
–	Read voltage		2.2	–	5.5	V
–	Program, erase temperature		0	–	60	°C
–	Data hold time ⁽⁷⁾	Ambient temperature = 55°C	20	–	–	year

NOTES:

1. VCC = 2.7 to 5.5 V at T_{opr} = 0 to 60°C, unless otherwise specified.
2. Definition of programming/erasure endurance
The programming and erasure endurance is defined on a per-block basis.
If the programming and erasure endurance is n (n = 100 or 10,000), each block can be erased n times. For example, if 1,024 1-byte writes are performed to block A, a 1 Kbyte block, and then the block is erased, the programming/erasure endurance still stands at one.
However, the same address must not be programmed more than once per erase operation (overwriting prohibited).
3. Endurance to guarantee all electrical characteristics after program and erase. (1 to Min. value can be guaranteed).
4. In a system that executes multiple programming operations, the actual erasure count can be reduced by writing to sequential addresses in turn so that as much of the block as possible is used up before performing an erase operation. For example, when programming groups of 16 bytes, the effective number of rewrites can be minimized by programming up to 128 groups before erasing them all in one operation. It is also advisable to retain data on the erase count of each block and limit the number of erase operations to a certain number.
5. If an error occurs during block erase, attempt to execute the clear status register command, then execute the block erase command at least three times until the erase error does not occur.
6. Customers desiring program/erase failure rate information should contact their Renesas technical support representative.
7. The data hold time includes time that the power supply is off or the clock is not supplied.

Table 5.4 Voltage Detection 0 Circuit Electrical Characteristics

Symbol	Parameter	Condition	Standard			Unit
			Min.	Typ.	Max.	
V _{det0}	Voltage detection level		2.2	2.3	2.4	V
–	Voltage detection circuit self power consumption	VCA25 = 1, V _{CC} = 5.0 V	–	0.9	–	μA
t _{d(E-A)}	Waiting time until voltage detection circuit operation starts ⁽²⁾		–	–	300	μs
V _{ccmin}	MCU operating voltage minimum value		2.2	–	–	V

NOTES:

1. The measurement condition is V_{CC} = 2.2 to 5.5 V and T_{opr} = –20 to 85°C (N version) / –40 to 85°C (D version).
2. Necessary time until the voltage detection circuit operates when setting to 1 again after setting the VCA25 bit in the VCA2 register to 0.

Table 5.5 Voltage Detection 1 Circuit Electrical Characteristics

Symbol	Parameter	Condition	Standard			Unit
			Min.	Typ.	Max.	
V _{det1}	Voltage detection level ⁽⁴⁾		2.70	2.85	3.00	V
–	Voltage monitor 1 interrupt request generation time ⁽²⁾		–	40	–	μs
–	Voltage detection circuit self power consumption	VCA26 = 1, V _{CC} = 5.0 V	–	0.6	–	μA
t _{d(E-A)}	Waiting time until voltage detection circuit operation starts ⁽³⁾		–	–	100	μs

NOTES:

1. The measurement condition is V_{CC} = 2.2 to 5.5 V and T_{opr} = –20 to 85°C (N version) / –40 to 85°C (D version).
2. Time until the voltage monitor 1 interrupt request is generated after the voltage passes V_{det1}.
3. Necessary time until the voltage detection circuit operates when setting to 1 again after setting the VCA26 bit in the VCA2 register to 0.
4. This parameter shows the voltage detection level when the power supply drops.
The voltage detection level when the power supply rises is higher than the voltage detection level when the power supply drops by approximately 0.1 V.

Table 5.6 Voltage Detection 2 Circuit Electrical Characteristics

Symbol	Parameter	Condition	Standard			Unit
			Min.	Typ.	Max.	
V _{det2}	Voltage detection level		3.3	3.6	3.9	V
–	Voltage monitor 2 interrupt request generation time ⁽²⁾		–	40	–	μs
–	Voltage detection circuit self power consumption	VCA27 = 1, V _{CC} = 5.0 V	–	0.6	–	μA
t _{d(E-A)}	Waiting time until voltage detection circuit operation starts ⁽³⁾		–	–	100	μs

NOTES:

1. The measurement condition is V_{CC} = 2.2 to 5.5 V and T_{opr} = –20 to 85°C (N version) / –40 to 85°C (D version).
2. Time until the voltage monitor 2 interrupt request is generated after the voltage passes V_{det2}.
3. Necessary time until the voltage detection circuit operates after setting to 1 again after setting the VCA27 bit in the VCA2 register to 0.

Table 5.7 Power-on Reset Circuit, Voltage Monitor 0 Reset Electrical Characteristics⁽³⁾

Symbol	Parameter	Condition	Standard			Unit
			Min.	Typ.	Max.	
V _{por1}	Power-on reset valid voltage ⁽⁴⁾		–	–	0.1	V
V _{por2}	Power-on reset or voltage monitor 0 reset valid voltage		0	–	V _{det0}	V
tr _{th}	External power V _{cc} rise gradient ⁽²⁾		20	–	–	mV/msec

NOTES:

1. The measurement condition is T_{opr} = –20 to 85°C (N version) / –40 to 85°C (D version), unless otherwise specified.
2. This condition (external power V_{cc} rise gradient) does not apply if V_{cc} ≥ 1.0 V.
3. To use the power-on reset function, enable voltage monitor 0 reset by setting the LVD0ON bit in the OFS register to 0, the VW0C0 and VW0C6 bits in the VW0C register to 1 respectively, and the VCA25 bit in the VCA2 register to 1.
4. t_{w(por1)} indicates the duration the external power V_{cc} must be held below the effective voltage (V_{por1}) to enable a power on reset. When turning on the power for the first time, maintain t_{w(por1)} for 30 s or more if –20°C ≤ T_{opr} ≤ 85°C, maintain t_{w(por1)} for 3,000 s or more if –40°C ≤ T_{opr} < –20°C.

**Figure 5.2 Reset Circuit Electrical Characteristics**

Table 5.8 Comparator Electrical Characteristics

Symbol	Parameter	Condition	Standard			Unit
			Min.	Typ.	Max.	
Vref	Internal reference voltage	VCC = 2.2 V to 5.5 V, Topr = 25°C	1.15	1.25	1.35	V
		VCC = 2.2 V to 5.5 V, Topr = -40 to 85°C	–	1.25	–	V
Vcref	External input reference voltage	VCC = 2.2 V to 4.0 V	0.5	–	VCC – 1.1	V
		VCC = 4.0 V to 5.5 V	0.5	–	VCC – 1.5	
Vcin	External comparison voltage input range		-0.3	–	VCC + 0.3	V
Vofs	Input offset voltage		–	20	120	mV
Tcrsp	Response time		–	4	–	μs

NOTE:

1. The measurement condition is Topr = -20 to 85°C (N version) / -40 to 85°C (D version), unless otherwise specified.

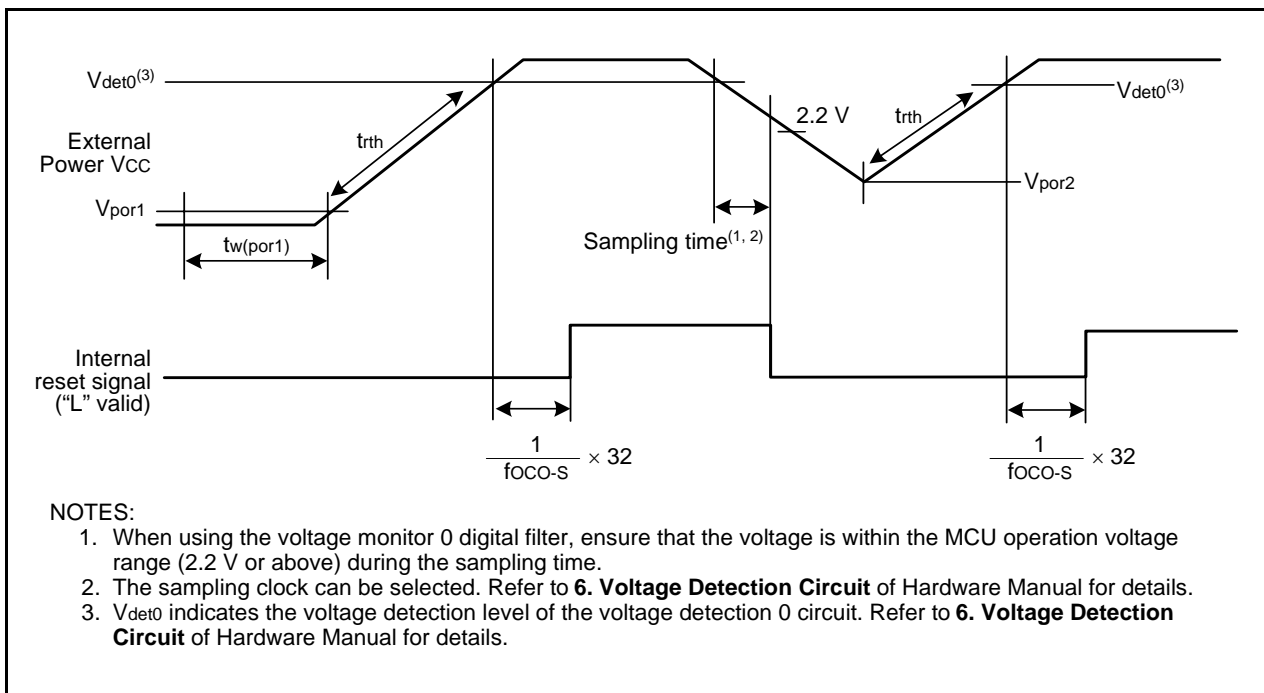
Table 5.9 High-speed On-Chip Oscillator Circuit Electrical Characteristics

Symbol	Parameter	Condition	Standard			Unit
			Min.	Typ.	Max.	
fOCO-F	High-speed on-chip oscillator frequency temperature • supply voltage dependence	VCC = 4.75 V to 5.25 V Topr = 0 to 60°C ⁽²⁾	7.76	8	8.24	MHz
		VCC = 2.7 V to 5.5 V Topr = -20 to 85°C ⁽²⁾	7.68	8	8.32	MHz
		VCC = 2.7 V to 5.5 V Topr = -40 to 85°C ⁽²⁾	7.44	8	8.32	MHz
		VCC = 2.2 V to 5.5 V Topr = -20 to 85°C ⁽³⁾	7.04	8	8.96	MHz
		VCC = 2.2 V to 5.5 V Topr = -40 to 85°C ⁽³⁾	6.8	8	9.2	MHz

NOTES:

1. The measurement condition is Topr = -20 to 85°C (N version) / -40 to 85°C (D version), unless otherwise specified.
2. These standard values show when the HRA1 register is set to the value before shipment and the HRA2 register is set to 00h.
3. These standard values show when the correction value in the FRA6 register is written into the HRA1 register.

Table 5.10 Low-speed On-Chip Oscillator Circuit Electrical Characteristics

Symbol	Parameter	Condition	Standard			Unit
			Min.	Typ.	Max.	
fOCO-S	Low-speed on-chip oscillator frequency		30	125	250	kHz
–	Oscillation stability time		–	10	100	μs
–	Self power consumption at oscillation	VCC = 5.0 V, Topr = 25°C	–	15	–	μA

NOTE:

1. VCC = 2.2 to 5.5 V, Topr = -20 to 85°C (N version) / -40 to 85°C (D version), unless otherwise specified.

Table 5.11 Power Supply Circuit Timing Characteristics

Symbol	Parameter	Condition	Standard			Unit
			Min.	Typ.	Max.	
td(P-R)	Time for internal power supply stabilization during power-on ⁽²⁾		1	–	2000	μs
td(R-S)	STOP exit time ⁽³⁾		–	–	150	μs

NOTES:

1. The measurement condition is VCC = 2.2 to 5.5 V and Topr = 25°C.
2. Waiting time until the internal power supply generation circuit stabilizes during power-on.
3. Time until system clock supply starts after the interrupt is acknowledged to exit stop mode.

Table 5.12 Electrical Characteristics (1) [V_{CC} = 5 V]

Symbol	Parameter		Condition	Standard			Unit
				Min.	Typ.	Max.	
V _{OH}	Output "H" voltage		I _{OH} = -5 mA	V _{CC} - 2.0	-	V _{CC}	V
			I _{OH} = -200 μA	V _{CC} - 0.5	-	V _{CC}	V
V _{OL}	Output "L" voltage		I _{OL} = 5 mA	-	-	2.0	V
			I _{OL} = 200 μA	-	-	0.45	V
V _{T+} -V _{T-}	Hysteresis	INT0, INT1, INT2, INT4, KI0, KI1, KI2, KI3, RXD0, RXD2, CLK0, CLK2		0.1	0.5	-	V
		RESET		0.1	1.0	-	V
I _{IH}	Input "H" current		V _I = 5 V, V _{CC} = 5 V	-	-	5.0	μA
I _{IL}	Input "L" current		V _I = 0 V, V _{CC} = 5 V	-	-	-5.0	μA
R _{PULLUP}	Pull-up resistance		V _I = 0 V, V _{CC} = 5 V	30	50	167	kΩ
R _{XCIN}	Feedback resistance	XCIN		-	18	-	MΩ
V _{RAM}	RAM hold voltage		During stop mode	2.0	-	-	V

NOTE:

- V_{CC} = 4.2 to 5.5 V at T_{opr} = -20 to 85°C (N version) / -40 to 85°C (D version), unless otherwise specified.

Table 5.13 Electrical Characteristics (2) [V_{CC} = 5 V]
(T_{opr} = -20 to 85°C (N version) / -40 to 85°C (D version), unless otherwise specified.)

Symbol	Parameter	Condition	Standard			Unit	
			Min.	Typ.	Max.		
I _{CC}	Power supply current (V _{CC} = 3.3 to 5.5 V) Single-chip mode, output pins are open, other pins are V _{SS}	High-speed on-chip oscillator mode	High-speed on-chip oscillator on = 8 MHz Low-speed on-chip oscillator on = 125 kHz No division	–	5	8	mA
			High-speed on-chip oscillator on = 8 MHz Low-speed on-chip oscillator on = 125 kHz Divide-by-8	–	2	–	mA
		Low-speed on-chip oscillator mode	High-speed on-chip oscillator off Low-speed on-chip oscillator on = 125 kHz Divide-by-8, FMR47 = 1	–	130	300	μA
			Low-speed clock mode	High-speed on-chip oscillator off Low-speed on-chip oscillator off XCIN clock oscillator on = 32 kHz (low drive) FMR47 = 1	–	130	300
		High-speed on-chip oscillator off Low-speed on-chip oscillator off XCIN clock oscillator on = 32 kHz (low drive) Program operation on RAM Flash memory off, FMSTP = 1		–	30	–	μA
		Wait mode	High-speed on-chip oscillator off Low-speed on-chip oscillator on = 125 kHz While a WAIT instruction is executed Peripheral clock operation VCA27 = VCA26 = VCA25 = 0 VCA20 = 1	–	25	75	μA
			High-speed on-chip oscillator off Low-speed on-chip oscillator on = 125 kHz While a WAIT instruction is executed Peripheral clock off VCA27 = VCA26 = VCA25 = 0 VCA20 = 1	–	23	60	μA
			High-speed on-chip oscillator off Low-speed on-chip oscillator off XCIN clock oscillator on = 32 kHz (high drive) While a WAIT instruction is executed VCA27 = VCA26 = VCA25 = 0 VCA20 = 1 BGR trimming circuit disabled (BGRCR0 = 1)	–	4	–	μA
			High-speed on-chip oscillator off Low-speed on-chip oscillator off XCIN clock oscillator on = 32 kHz (low drive) While a WAIT instruction is executed VCA27 = VCA26 = VCA25 = 0 VCA20 = 1 BGR trimming circuit disabled (BGRCR0 = 1)	–	2.2	–	μA
			High-speed on-chip oscillator off Low-speed on-chip oscillator off XCIN clock oscillator on = 32 kHz (high drive) While a WAIT instruction is executed VCA27 = VCA26 = VCA25 = 0 VCA20 = 1 BGR trimming circuit enabled (BGRCR0 = 0)	–	8	–	μA
			High-speed on-chip oscillator off Low-speed on-chip oscillator off XCIN clock oscillator on = 32 kHz (low drive) While a WAIT instruction is executed VCA27 = VCA26 = VCA25 = 0 VCA20 = 1 BGR trimming circuit enabled (BGRCR0 = 0)	–	6	–	μA
			Stop mode	XCIN clock off, T _{opr} = 25°C High-speed on-chip oscillator off Low-speed on-chip oscillator off CM10 = 1 Peripheral clock off VCA27 = VCA26 = VCA25 = 0 BGR trimming circuit disabled (BGRCR0 = 1)	–	0.8	3
		XCIN clock off, T _{opr} = 85°C High-speed on-chip oscillator off Low-speed on-chip oscillator off CM10 = 1 Peripheral clock off VCA27 = VCA26 = VCA25 = 0 BGR trimming circuit disabled (BGRCR0 = 1)		–	1.2	–	μA
		XCIN clock off, T _{opr} = 25°C High-speed on-chip oscillator off Low-speed on-chip oscillator off CM10 = 1 Peripheral clock off VCA27 = VCA26 = VCA25 = 0 BGR trimming circuit enabled (BGRCR0 = 0)		–	5	8	μA
		XCIN clock off, T _{opr} = 85°C High-speed on-chip oscillator off Low-speed on-chip oscillator off CM10 = 1 Peripheral clock off VCA27 = VCA26 = VCA25 = 0 BGR trimming circuit enabled (BGRCR0 = 0)		–	5.5	–	μA

Timing Requirements**(Unless Otherwise Specified: $V_{CC} = 5\text{ V}$, $V_{SS} = 0\text{ V}$ at $T_{opr} = 25^\circ\text{C}$) [$V_{CC} = 5\text{ V}$]****Table 5.14 XCIN Input**

Symbol	Parameter	Standard		Unit
		Min.	Max.	
$t_{c(XCIN)}$	XCIN input cycle time	14	–	μs
$t_{WH(XCIN)}$	XCIN input "H" width	7	–	μs
$t_{WL(XCIN)}$	XCIN input "L" width	7	–	μs

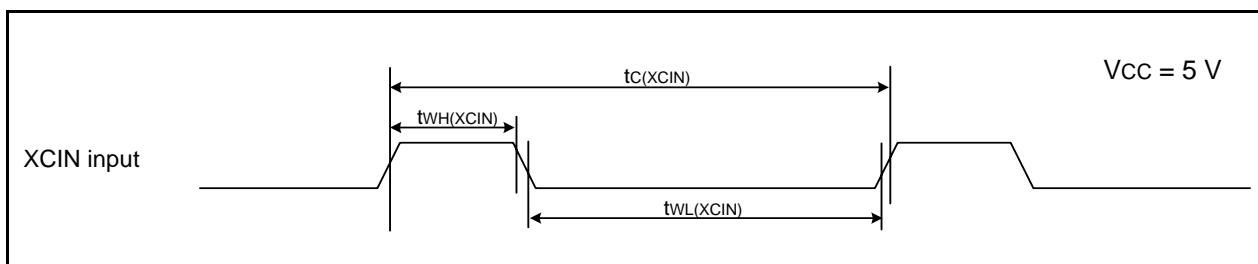
**Figure 5.3 XCIN Input Timing Diagram when $V_{CC} = 5\text{ V}$** **Table 5.15 TRAI0 Input**

Symbol	Parameter	Standard		Unit
		Min.	Max.	
$t_{c(TRAIO)}$	TRAIO input cycle time	100	–	ns
$t_{WH(TRAIO)}$	TRAIO input "H" width	40	–	ns
$t_{WL(TRAIO)}$	TRAIO input "L" width	40	–	ns

**Figure 5.4 TRAI0 Input Timing Diagram when $V_{CC} = 5\text{ V}$**

Table 5.16 Serial Interface

Symbol	Parameter	Standard		Unit
		Min.	Max.	
$t_{c(CK)}$	CLKi input cycle time	200	–	ns
$t_{w(CKH)}$	CLKi input “H” width	100	–	ns
$t_{w(CKL)}$	CLKi input “L” width	100	–	ns
$t_{d(C-Q)}$	TXDi output delay time	–	50	ns
$t_{h(C-Q)}$	TXDi hold time	0	–	ns
$t_{su(D-C)}$	RXDi input setup time	50	–	ns
$t_{h(C-D)}$	RXDi input hold time	90	–	ns

i = 0 or 2

**Figure 5.5 Serial Interface Timing Diagram when Vcc = 5 V****Table 5.17 External Interrupt \overline{INTi} (i = 0, 1, 2, 4) Input**

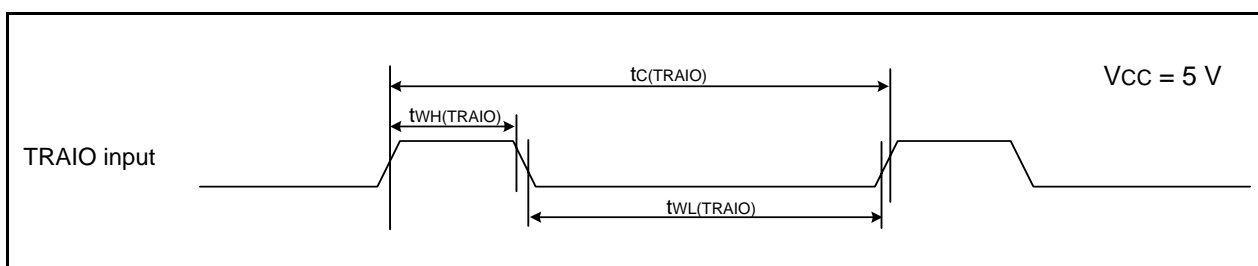
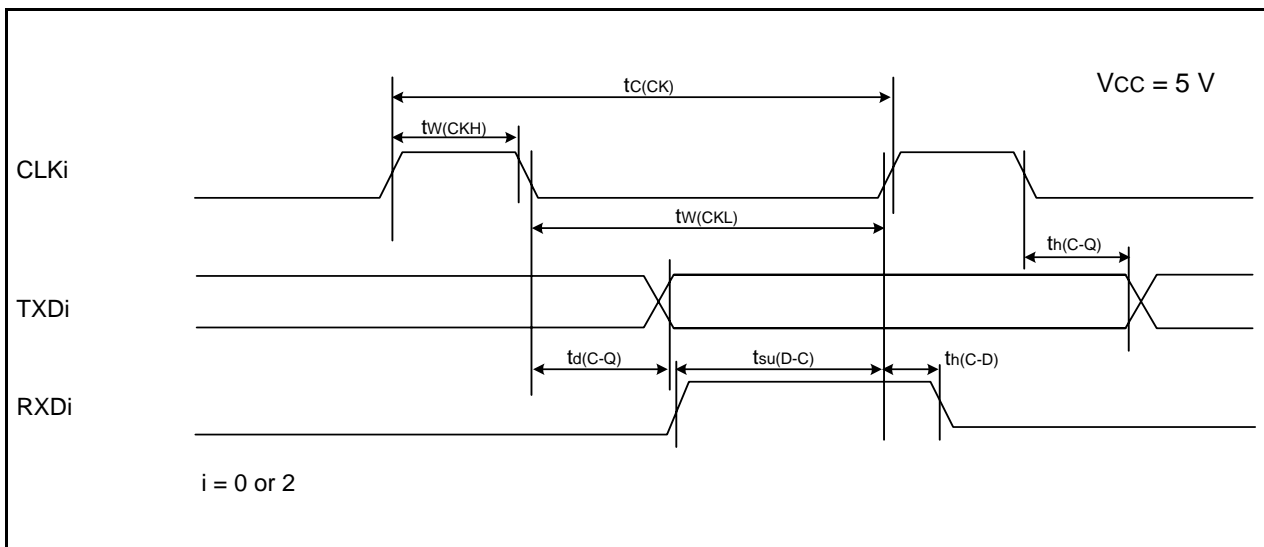
Symbol	Parameter	Standard		Unit
		Min.	Max.	
$t_{w(INH)}$	\overline{INTi} input “H” width	250 ⁽¹⁾	–	ns
$t_{w(INL)}$	\overline{INTi} input “L” width	250 ⁽²⁾	–	ns

NOTES:

- When selecting the digital filter by the \overline{INTi} input filter select bit, use an \overline{INTi} input HIGH width of either (1/digital filter clock frequency × 3) or the minimum value of standard, whichever is greater.
- When selecting the digital filter by the \overline{INTi} input filter select bit, use an \overline{INTi} input LOW width of either (1/digital filter clock frequency × 3) or the minimum value of standard, whichever is greater.

**Figure 5.6 External Interrupt \overline{INTi} Input Timing Diagram when Vcc = 5 V**

Table 5.18 Electrical Characteristics (3) [V_{CC} = 3 V]

Symbol	Parameter		Condition	Standard			Unit
				Min.	Typ.	Max.	
V _{OH}	Output "H" voltage		I _{OH} = -1 mA	V _{CC} - 0.5	-	V _{CC}	V
V _{OL}	Output "L" voltage		I _{OL} = 1 mA	-	-	0.5	V
V _{T+} -V _{T-}	Hysteresis	INT0, INT1, INT2, INT4, K10, K11, K12, K13, RXD0, RXD2, CLK0, CLK2		0.1	0.3	-	V
		RESET		0.1	0.4	-	V
I _{IH}	Input "H" current		V _I = 3 V, V _{CC} = 3 V	-	-	4.0	μA
I _{IL}	Input "L" current		V _I = 0 V, V _{CC} = 3 V	-	-	-4.0	μA
R _{PULLUP}	Pull-up resistance		V _I = 0 V, V _{CC} = 3 V	66	160	500	kΩ
R _{XCIN}	Feedback resistance	XCIN		-	18	-	MΩ
V _{RAM}	RAM hold voltage		During stop mode	1.8	-	-	V

NOTE:

- V_{CC} = 2.7 to 3.3 V at T_{opr} = -20 to 85°C (N version) / -40 to 85°C (D version), unless otherwise specified.

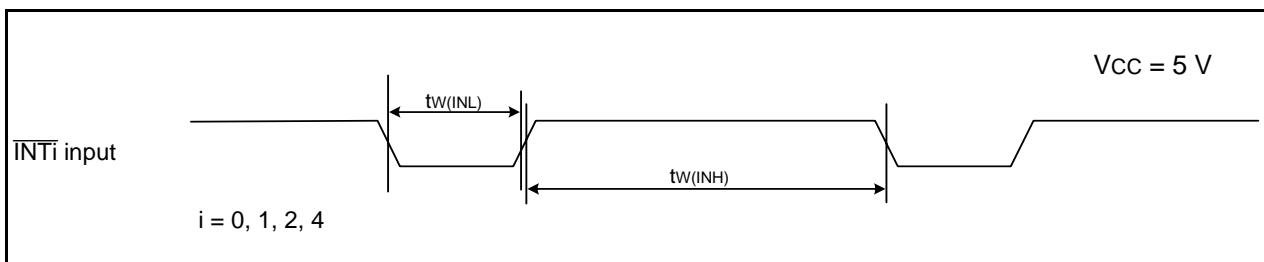
**Table 5.19 Electrical Characteristics (4) [Vcc = 3 V]
(Topr = -20 to 85°C (N version) / -40 to 85°C (D version), unless otherwise specified.)**

Symbol	Parameter	Condition	Standard			Unit	
			Min.	Typ.	Max.		
Icc	Power supply current (Vcc = 2.7 to 3.3 V) Single-chip mode, output pins are open, other pins are Vss	High-speed on-chip oscillator mode	High-speed on-chip oscillator on = 8 MHz Low-speed on-chip oscillator on = 125 kHz No division	–	5	–	mA
			High-speed on-chip oscillator on = 8 MHz Low-speed on-chip oscillator on = 125 kHz Divide-by-8	–	2	–	mA
		Low-speed on-chip oscillator mode	High-speed on-chip oscillator off Low-speed on-chip oscillator on = 125 kHz Divide-by-8, FMR47 = 1	–	130	300	μA
			Low-speed clock mode	High-speed on-chip oscillator off Low-speed on-chip oscillator off XCIN clock oscillator on = 32 kHz (low drive) FMR47 = 1	–	130	300
		High-speed on-chip oscillator off Low-speed on-chip oscillator off XCIN clock oscillator on = 32 kHz (low drive) Program operation on RAM Flash memory off, FMSTP = 1		–	30	–	μA
		Wait mode	High-speed on-chip oscillator off Low-speed on-chip oscillator on = 125 kHz While a WAIT instruction is executed Peripheral clock operation VCA27 = VCA26 = VCA25 = 0 VCA20 = 1	–	25	70	μA
			High-speed on-chip oscillator off Low-speed on-chip oscillator on = 125 kHz While a WAIT instruction is executed Peripheral clock off VCA27 = VCA26 = VCA25 = 0 VCA20 = 1	–	23	55	μA
			High-speed on-chip oscillator off Low-speed on-chip oscillator off XCIN clock oscillator on = 32 kHz (high drive) While a WAIT instruction is executed VCA27 = VCA26 = VCA25 = 0 VCA20 = 1 BGR trimming circuit disabled (BGRCR0 = 1)	–	3.8	–	μA
			High-speed on-chip oscillator off Low-speed on-chip oscillator off XCIN clock oscillator on = 32 kHz (low drive) While a WAIT instruction is executed VCA27 = VCA26 = VCA25 = 0 VCA20 = 1 BGR trimming circuit disabled (BGRCR0 = 1)	–	2	–	μA
			High-speed on-chip oscillator off Low-speed on-chip oscillator off XCIN clock oscillator on = 32 kHz (high drive) While a WAIT instruction is executed VCA27 = VCA26 = VCA25 = 0 VCA20 = 1 BGR trimming circuit enabled (BGRCR0 = 0)	–	8	–	μA
			High-speed on-chip oscillator off Low-speed on-chip oscillator off XCIN clock oscillator on = 32 kHz (low drive) While a WAIT instruction is executed VCA27 = VCA26 = VCA25 = 0 VCA20 = 1 BGR trimming circuit enabled (BGRCR0 = 0)	–	6	–	μA
			Stop mode	XCIN clock off, Topr = 25°C High-speed on-chip oscillator off Low-speed on-chip oscillator off CM10 = 1 Peripheral clock off VCA27 = VCA26 = VCA25 = 0 BGR trimming circuit disabled (BGRCR0 = 1)	–	0.7	3
		XCIN clock off, Topr = 85°C High-speed on-chip oscillator off Low-speed on-chip oscillator off CM10 = 1 Peripheral clock off VCA27 = VCA26 = VCA25 = 0 BGR trimming circuit disabled (BGRCR0 = 1)		–	1.1	–	μA
		XCIN clock off, Topr = 25°C High-speed on-chip oscillator off Low-speed on-chip oscillator off CM10 = 1 Peripheral clock off VCA27 = VCA26 = VCA25 = 0 BGR trimming circuit enabled (BGRCR0 = 0)		–	5	7	μA
		XCIN clock off, Topr = 85°C High-speed on-chip oscillator off Low-speed on-chip oscillator off CM10 = 1 Peripheral clock off VCA27 = VCA26 = VCA25 = 0 BGR trimming circuit enabled (BGRCR0 = 0)		–	5.5	–	μA

Timing requirements

(Unless Otherwise Specified: $V_{CC} = 3\text{ V}$, $V_{SS} = 0\text{ V}$ at $T_{opr} = 25^{\circ}\text{C}$) [$V_{CC} = 3\text{ V}$]

Table 5.20 XCIN Input

Symbol	Parameter	Standard		Unit
		Min.	Max.	
$t_{c(XCIN)}$	XCIN input cycle time	14	–	μs
$t_{WH(XCIN)}$	XCIN input "H" width	7	–	μs
$t_{WL(XCIN)}$	XCIN input "L" width	7	–	μs

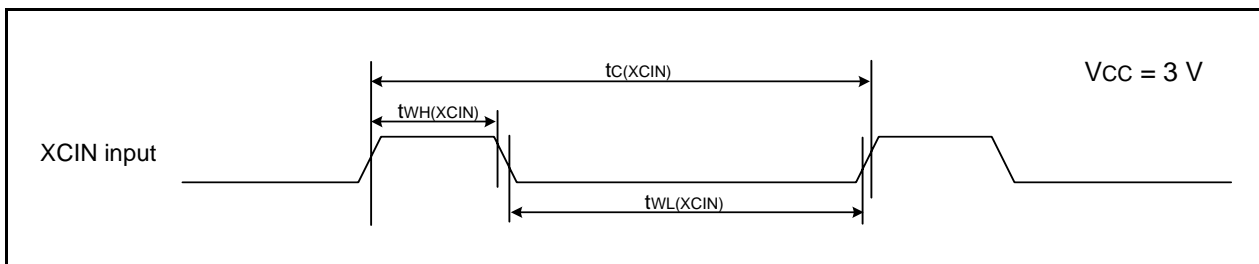

Figure 5.7 XCIN Input Timing Diagram when $V_{CC} = 3\text{ V}$

Table 5.21 TRAI0 Input

Symbol	Parameter	Standard		Unit
		Min.	Max.	
$t_{c(TRAIO)}$	TRAIO input cycle time	300	–	ns
$t_{WH(TRAIO)}$	TRAIO input "H" width	120	–	ns
$t_{WL(TRAIO)}$	TRAIO input "L" width	120	–	ns

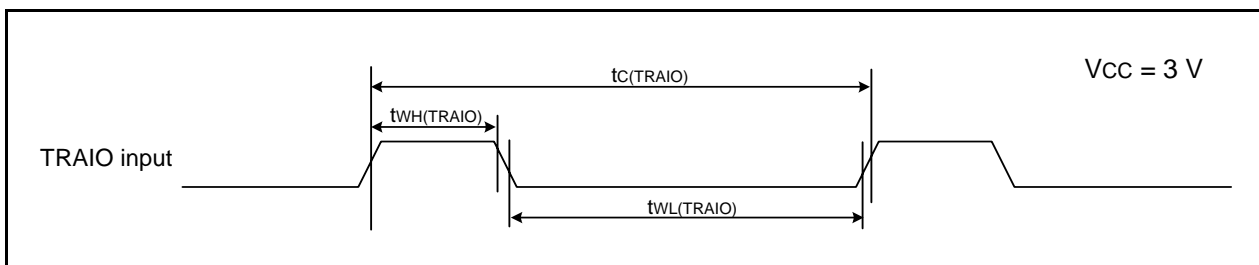

Figure 5.8 TRAI0 Input Timing Diagram when $V_{CC} = 3\text{ V}$

Table 5.22 Serial Interface

Symbol	Parameter	Standard		Unit
		Min.	Max.	
$t_{c(CK)}$	CLKi input cycle time	300	–	ns
$t_{w(CKH)}$	CLKi input “H” width	150	–	ns
$t_{w(CKL)}$	CLKi Input “L” width	150	–	ns
$t_{d(C-Q)}$	TXDi output delay time	–	80	ns
$t_{h(C-Q)}$	TXDi hold time	0	–	ns
$t_{su(D-C)}$	RXDi input setup time	70	–	ns
$t_{h(C-D)}$	RXDi input hold time	90	–	ns

i = 0 or 2

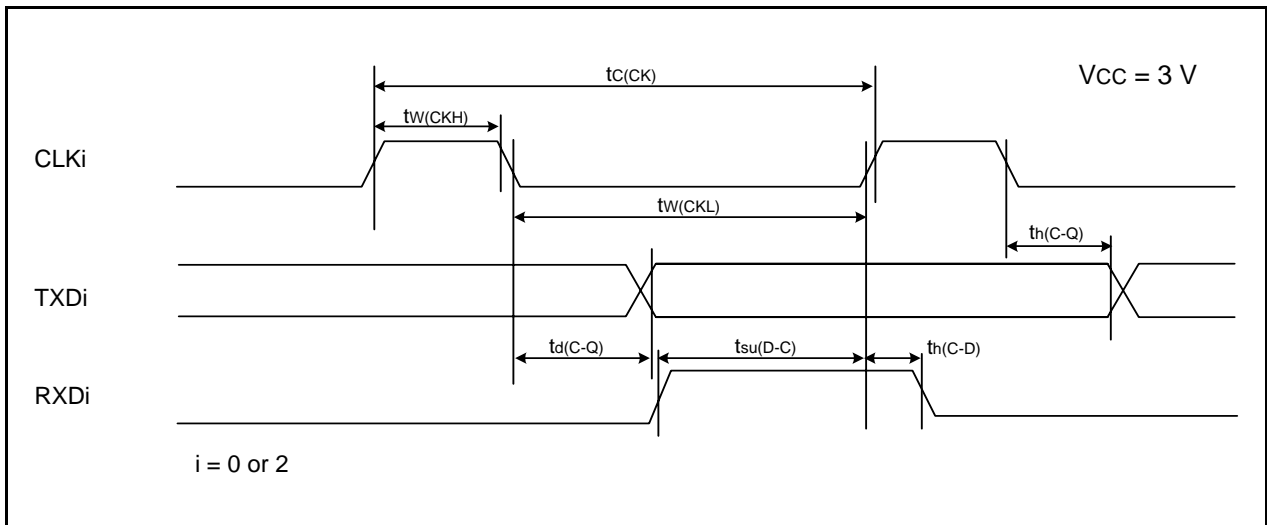

Figure 5.9 Serial Interface Timing Diagram when Vcc = 3 V

Table 5.23 External Interrupt \overline{INTi} (i = 0, 1, 2, 4) Input

Symbol	Parameter	Standard		Unit
		Min.	Max.	
$t_{w(INH)}$	\overline{INTi} input “H” width	380 ⁽¹⁾	–	ns
$t_{w(INL)}$	\overline{INTi} input “L” width	380 ⁽²⁾	–	ns

NOTES:

1. When selecting the digital filter by the \overline{INTi} input filter select bit, use an \overline{INTi} input HIGH width of either (1/digital filter clock frequency × 3) or the minimum value of standard, whichever is greater.
2. When selecting the digital filter by the \overline{INTi} input filter select bit, use an \overline{INTi} input LOW width of either (1/digital filter clock frequency × 3) or the minimum value of standard, whichever is greater.

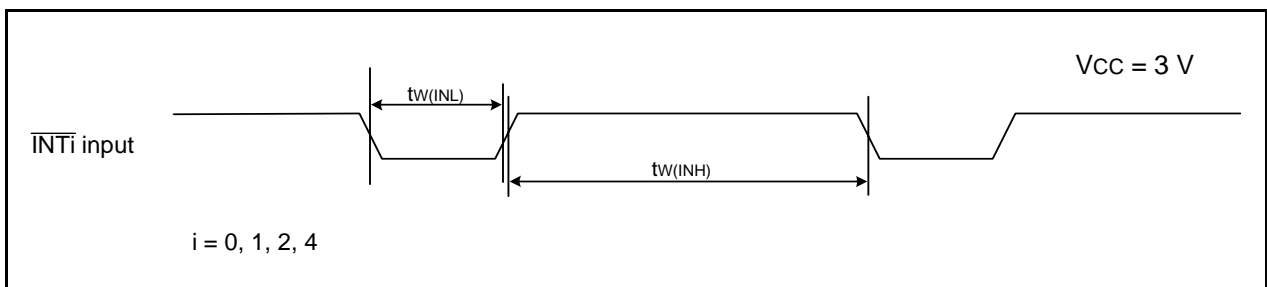

Figure 5.10 External Interrupt \overline{INTi} Input Timing Diagram when Vcc = 3 V

Table 5.24 Electrical Characteristics (5) [V_{CC} = 2.2 V]

Symbol	Parameter		Condition	Standard			Unit
				Min.	Typ.	Max.	
V _{OH}	Output "H" voltage		I _{OH} = -1 mA	V _{CC} - 0.5	-	V _{CC}	V
V _{OL}	Output "L" voltage		I _{OL} = 1 mA	-	-	0.5	V
V _{T+} -V _{T-}	Hysteresis	INT0, INT1, INT2, INT4, K10, K11, K12, K13, RXD0, RXD2, CLK0, CLK2		0.05	0.3	-	V
		RESET		0.05	0.15	-	V
I _{IH}	Input "H" current		V _I = 2.2 V	-	-	4.0	μA
I _{IL}	Input "L" current		V _I = 0 V	-	-	-4.0	μA
R _{PULLUP}	Pull-up resistance		V _I = 0 V	100	200	600	kΩ
R _{XCIN}	Feedback resistance	XCIN		-	35	-	MΩ
V _{RAM}	RAM hold voltage		During stop mode	1.8	-	-	V

NOTE:

- V_{CC} = 2.2 V at T_{opr} = -20 to 85°C (N version) / -40 to 85°C (D version), unless otherwise specified.

Table 5.25 Electrical Characteristics (6) [V_{CC} = 2.2 V]
(T_{opr} = -20 to 85°C (N version) / -40 to 85°C (D version), unless otherwise specified.)

Symbol	Parameter	Condition	Standard			Unit	
			Min.	Typ.	Max.		
I _{CC}	Power supply current (V _{CC} = 2.2 to 2.7 V) Single-chip mode, output pins are open, other pins are V _{SS}	High-speed on-chip oscillator mode	High-speed on-chip oscillator on = 4 MHz Low-speed on-chip oscillator on = 125 kHz No division	–	3.5	–	mA
			High-speed on-chip oscillator on = 4 MHz Low-speed on-chip oscillator on = 125 kHz Divide-by-8	–	1.5	–	mA
		Low-speed on-chip oscillator mode	High-speed on-chip oscillator off Low-speed on-chip oscillator on = 125 kHz Divide-by-8, FMR47 = 1	–	100	230	μA
			Low-speed clock mode	High-speed on-chip oscillator off Low-speed on-chip oscillator off XCIN clock oscillator on = 32 kHz (low drive) FMR47 = 1	–	100	230
		High-speed on-chip oscillator off Low-speed on-chip oscillator off XCIN clock oscillator on = 32 kHz (low drive) Program operation on RAM Flash memory off, FMSTP = 1		–	25	–	μA
		Wait mode	High-speed on-chip oscillator off Low-speed on-chip oscillator on = 125 kHz While a WAIT instruction is executed Peripheral clock operation VCA27 = VCA26 = VCA25 = 0 VCA20 = 1	–	22	60	μA
			High-speed on-chip oscillator off Low-speed on-chip oscillator on = 125 kHz While a WAIT instruction is executed Peripheral clock off VCA27 = VCA26 = VCA25 = 0 VCA20 = 1	–	20	55	μA
			High-speed on-chip oscillator off Low-speed on-chip oscillator off XCIN clock oscillator on = 32 kHz (high drive) While a WAIT instruction is executed VCA27 = VCA26 = VCA25 = 0 VCA20 = 1 BGR trimming circuit disabled (BGRCR0 = 1)	–	3	–	μA
			High-speed on-chip oscillator off Low-speed on-chip oscillator off XCIN clock oscillator on = 32 kHz (low drive) While a WAIT instruction is executed VCA27 = VCA26 = VCA25 = 0 VCA20 = 1 BGR trimming circuit disabled (BGRCR0 = 1)	–	1.8	–	μA
			High-speed on-chip oscillator off Low-speed on-chip oscillator off XCIN clock oscillator on = 32 kHz (high drive) While a WAIT instruction is executed VCA27 = VCA26 = VCA25 = 0 VCA20 = 1 BGR trimming circuit enabled (BGRCR0 = 0)	–	7	–	μA
			High-speed on-chip oscillator off Low-speed on-chip oscillator off XCIN clock oscillator on = 32 kHz (low drive) While a WAIT instruction is executed VCA27 = VCA26 = VCA25 = 0 VCA20 = 1 BGR trimming circuit enabled (BGRCR0 = 0)	–	6	–	μA
			Stop mode	XCIN clock off, T _{opr} = 25°C High-speed on-chip oscillator off Low-speed on-chip oscillator off CM10 = 1 Peripheral clock off VCA27 = VCA26 = VCA25 = 0 BGR trimming circuit disabled (BGRCR0 = 1)	–	0.7	3
		XCIN clock off, T _{opr} = 85°C High-speed on-chip oscillator off Low-speed on-chip oscillator off CM10 = 1 Peripheral clock off VCA27 = VCA26 = VCA25 = 0 BGR trimming circuit disabled (BGRCR0 = 1)		–	1.1	–	μA
		XCIN clock off, T _{opr} = 25°C High-speed on-chip oscillator off Low-speed on-chip oscillator off CM10 = 1 Peripheral clock off VCA27 = VCA26 = VCA25 = 0 BGR trimming circuit enabled (BGRCR0 = 0)		–	5	7	μA
		XCIN clock off, T _{opr} = 85°C High-speed on-chip oscillator off Low-speed on-chip oscillator off CM10 = 1 Peripheral clock off VCA27 = VCA26 = VCA25 = 0 BGR trimming circuit enabled (BGRCR0 = 0)		–	5.5	–	μA

Timing requirements**(Unless Otherwise Specified: $V_{CC} = 2.2\text{ V}$, $V_{SS} = 0\text{ V}$ at $T_{opr} = 25^{\circ}\text{C}$) [$V_{CC} = 2.2\text{ V}$]****Table 5.26 XCIN Input**

Symbol	Parameter	Standard		Unit
		Min.	Max.	
$t_{c(XCIN)}$	XCIN input cycle time	14	–	μs
$t_{WH(XCIN)}$	XCIN input "H" width	7	–	μs
$t_{WL(XCIN)}$	XCIN input "L" width	7	–	μs

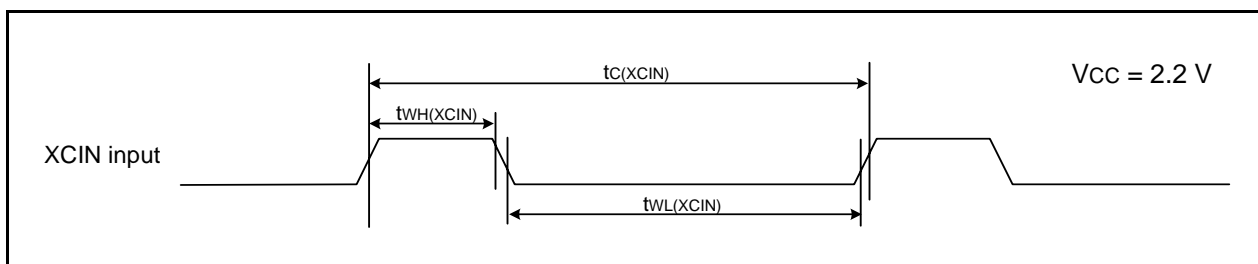
**Figure 5.11 XCIN Input Timing Diagram when $V_{CC} = 2.2\text{ V}$** **Table 5.27 TRAI0 Input**

Symbol	Parameter	Standard		Unit
		Min.	Max.	
$t_{c(TRAI0)}$	TRAI0 input cycle time	500	–	ns
$t_{WH(TRAI0)}$	TRAI0 input "H" width	200	–	ns
$t_{WL(TRAI0)}$	TRAI0 input "L" width	200	–	ns

**Figure 5.12 TRAI0 Input Timing Diagram when $V_{CC} = 2.2\text{ V}$**

Table 5.28 Serial Interface

Symbol	Parameter	Standard		Unit
		Min.	Max.	
$t_{c(CK)}$	CLKi input cycle time	800	–	ns
$t_{w(CKH)}$	CLKi input “H” width	400	–	ns
$t_{w(CKL)}$	CLKi input “L” width	400	–	ns
$t_{d(C-Q)}$	TXDi output delay time	–	200	ns
$t_{h(C-Q)}$	TXDi hold time	0	–	ns
$t_{su(D-C)}$	RXDi input setup time	150	–	ns
$t_{h(C-D)}$	RXDi input hold time	90	–	ns

i = 0 or 2

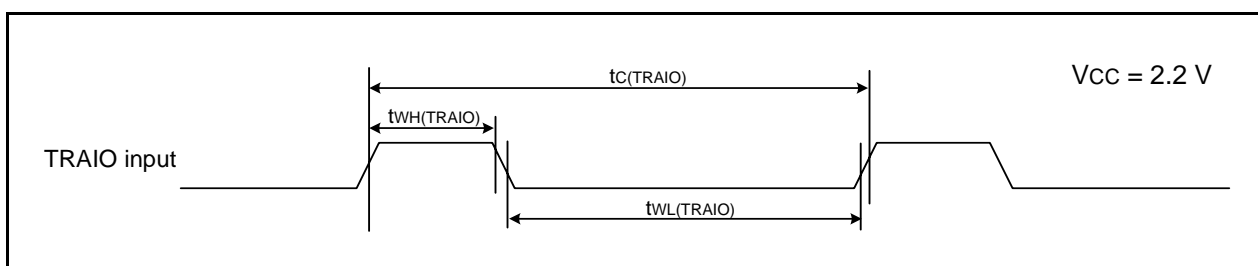
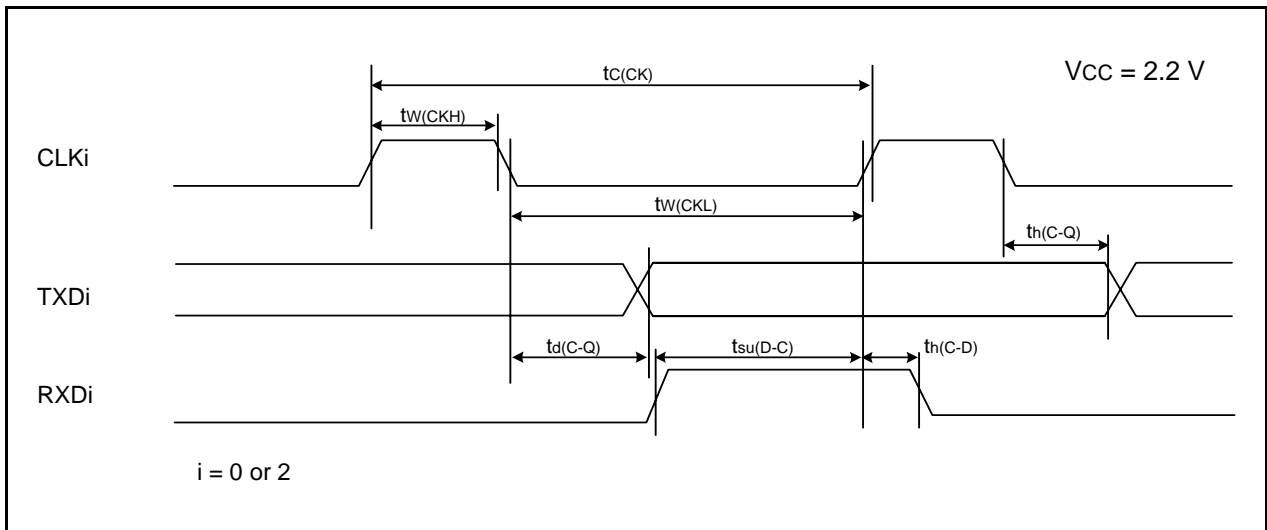

Figure 5.13 Serial Interface Timing Diagram when Vcc = 2.2 V

Table 5.29 External Interrupt \overline{INTi} (i = 0, 1, 2, 4) Input

Symbol	Parameter	Standard		Unit
		Min.	Max.	
$t_{w(INH)}$	\overline{INTi} input “H” width	1000 ⁽¹⁾	–	ns
$t_{w(INL)}$	\overline{INTi} input “L” width	1000 ⁽²⁾	–	ns

NOTES:

1. When selecting the digital filter by the \overline{INTi} input filter select bit, use an \overline{INTi} input HIGH width of either (1/digital filter clock frequency × 3) or the minimum value of standard, whichever is greater.
2. When selecting the digital filter by the \overline{INTi} input filter select bit, use an \overline{INTi} input LOW width of either (1/digital filter clock frequency × 3) or the minimum value of standard, whichever is greater.

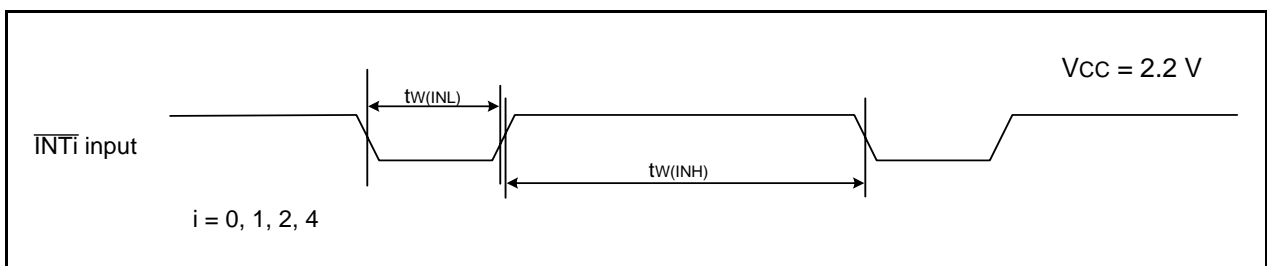
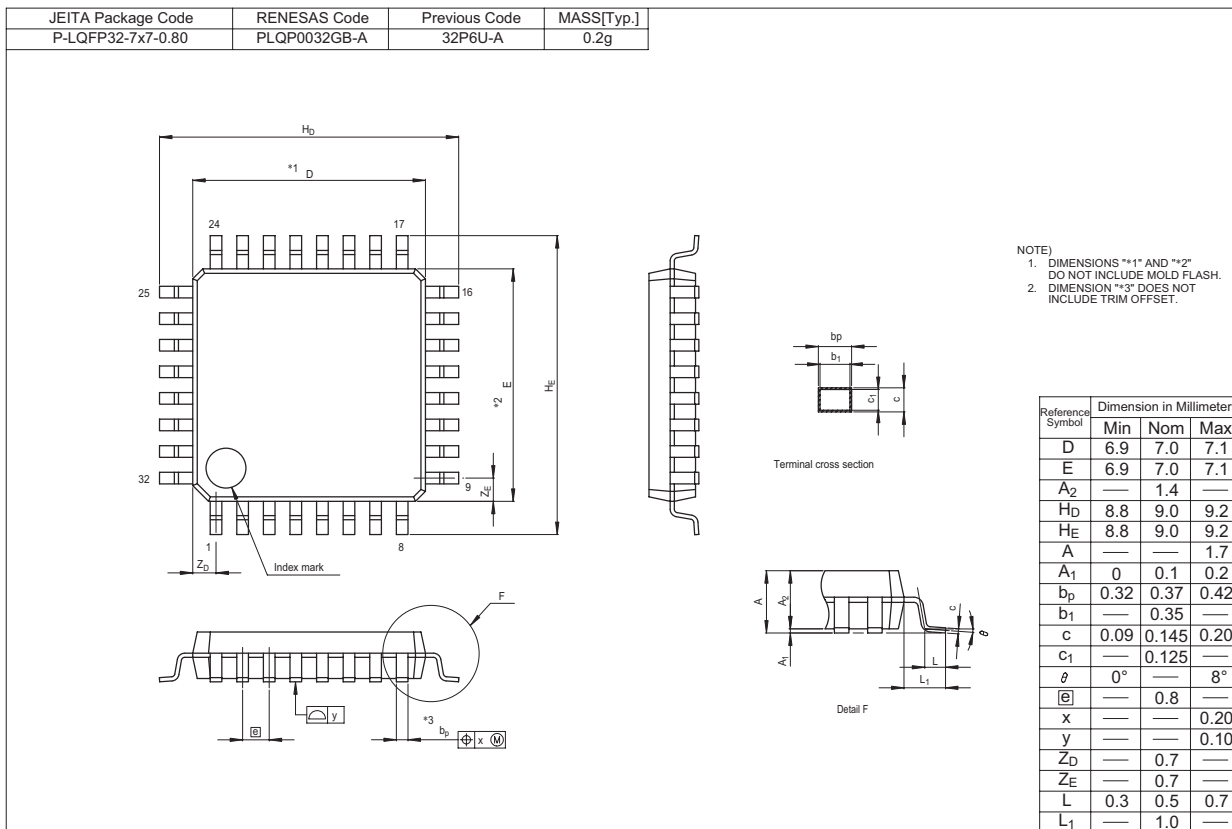

Figure 5.14 External Interrupt \overline{INTi} Input Timing Diagram when Vcc = 2.2 V

Package Dimensions

Diagrams showing the latest package dimensions and mounting information are available in the “Packages” section of the Renesas Technology website.



REVISION HISTORY

R8C/2G Group Datasheet

Rev.	Date	Description	
		Page	Summary
0.10	Jul 20, 2007	–	First Edition issued
0.20	Nov 12, 2007	2	Table 1.1 I/O Ports: “• Output-only: 1” added “• CMOS I/O ports: 28” → “• CMOS I/O ports: 27”
		4	Figure 1.2 revised
		5	Figure 1.3 revised
		6	Table 1.3 Pin Number: 4, 6, 20 revised
		7	Table 1.4 I/O port: “P4_3 to P4_5” → “P4_3, P4_5” Output port added
		12	Table 4.1 0006h “01001000b” → “01011000b”
		16	Table 4.5 0118h to 011Dh: After reset revised 011Fh “Timer RE Real-Time Clock Precision Adjust Register” added
		24	Table 5.2 NOTE2 revised
1.00	Apr 04, 2008	All pages	“Under development” deleted
		2	Table 1.1 revised
		3	Table 1.2 “(D): Under development” deleted
		11	Figure 3.1 “Expanded area” deleted
		12	Table 4.1 “002Eh” “002Fh” revised
		13	Table 4.2 “003Eh” “003Fh” revised
		25	Table 5.3 revised Figure 5.2 deleted
		28	Table 5.8, Table 5.11 revised Table 5.9 revised, NOTE3 added
		30	Table 5.13 revised
34	Table 5.19 revised		
		38	Table 5.25 revised

All trademarks and registered trademarks are the property of their respective owners.

Notes:

1. This document is provided for reference purposes only so that Renesas customers may select the appropriate Renesas products for their use. Renesas neither makes warranties or representations with respect to the accuracy or completeness of the information contained in this document nor grants any license to any intellectual property rights or any other rights of Renesas or any third party with respect to the information in this document.
2. Renesas shall have no liability for damages or infringement of any intellectual property or other rights arising out of the use of any information in this document, including, but not limited to, product data, diagrams, charts, programs, algorithms, and application circuit examples.
3. You should not use the products or the technology described in this document for the purpose of military applications such as the development of weapons of mass destruction or for the purpose of any other military use. When exporting the products or technology described herein, you should follow the applicable export control laws and regulations, and procedures required by such laws and regulations.
4. All information included in this document such as product data, diagrams, charts, programs, algorithms, and application circuit examples, is current as of the date this document is issued. Such information, however, is subject to change without any prior notice. Before purchasing or using any Renesas products listed in this document, please confirm the latest product information with a Renesas sales office. Also, please pay regular and careful attention to additional and different information to be disclosed by Renesas such as that disclosed through our website. (<http://www.renesas.com>)
5. Renesas has used reasonable care in compiling the information included in this document, but Renesas assumes no liability whatsoever for any damages incurred as a result of errors or omissions in the information included in this document.
6. When using or otherwise relying on the information in this document, you should evaluate the information in light of the total system before deciding about the applicability of such information to the intended application. Renesas makes no representations, warranties or guarantees regarding the suitability of its products for any particular application and specifically disclaims any liability arising out of the application and use of the information in this document or Renesas products.
7. With the exception of products specified by Renesas as suitable for automobile applications, Renesas products are not designed, manufactured or tested for applications or otherwise in systems the failure or malfunction of which may cause a direct threat to human life or create a risk of human injury or which require especially high quality and reliability such as safety systems, or equipment or systems for transportation and traffic, healthcare, combustion control, aerospace and aeronautics, nuclear power, or undersea communication transmission. If you are considering the use of our products for such purposes, please contact a Renesas sales office beforehand. Renesas shall have no liability for damages arising out of the uses set forth above.
8. Notwithstanding the preceding paragraph, you should not use Renesas products for the purposes listed below:
 - (1) artificial life support devices or systems
 - (2) surgical implantations
 - (3) healthcare intervention (e.g., excision, administration of medication, etc.)
 - (4) any other purposes that pose a direct threat to human lifeRenesas shall have no liability for damages arising out of the uses set forth in the above and purchasers who elect to use Renesas products in any of the foregoing applications shall indemnify and hold harmless Renesas Technology Corp., its affiliated companies and their officers, directors, and employees against any and all damages arising out of such applications.
9. You should use the products described herein within the range specified by Renesas, especially with respect to the maximum rating, operating supply voltage range, movement power voltage range, heat radiation characteristics, installation and other product characteristics. Renesas shall have no liability for malfunctions or damages arising out of the use of Renesas products beyond such specified ranges.
10. Although Renesas endeavors to improve the quality and reliability of its products, IC products have specific characteristics such as the occurrence of failure at a certain rate and malfunctions under certain use conditions. Please be sure to implement safety measures to guard against the possibility of physical injury, and injury or damage caused by fire in the event of the failure of a Renesas product, such as safety design for hardware and software including but not limited to redundancy, fire control and malfunction prevention, appropriate treatment for aging degradation or any other applicable measures. Among others, since the evaluation of microcomputer software alone is very difficult, please evaluate the safety of the final products or system manufactured by you.
11. In case Renesas products listed in this document are detached from the products to which the Renesas products are attached or affixed, the risk of accident such as swallowing by infants and small children is very high. You should implement safety measures so that Renesas products may not be easily detached from your products. Renesas shall have no liability for damages arising out of such detachment.
12. This document may not be reproduced or duplicated, in any form, in whole or in part, without prior written approval from Renesas.
13. Please contact a Renesas sales office if you have any questions regarding the information contained in this document, Renesas semiconductor products, or if you have any other inquiries.



RENESAS SALES OFFICES

<http://www.renesas.com>

Refer to "<http://www.renesas.com/en/network>" for the latest and detailed information.

Renesas Technology America, Inc.
450 Holger Way, San Jose, CA 95134-1368, U.S.A
Tel: <1> (408) 382-7500, Fax: <1> (408) 382-7501

Renesas Technology Europe Limited
Dukes Meadow, Millboard Road, Bourne End, Buckinghamshire, SL8 5FH, U.K.
Tel: <44> (1628) 585-100, Fax: <44> (1628) 585-900

Renesas Technology (Shanghai) Co., Ltd.
Unit 204, 205, AZIACenter, No.1233 Lujiazui Ring Rd, Pudong District, Shanghai, China 200120
Tel: <86> (21) 5877-1818, Fax: <86> (21) 6887-7858/7898

Renesas Technology Hong Kong Ltd.
7th Floor, North Tower, World Finance Centre, Harbour City, Canton Road, Tsimshatsui, Kowloon, Hong Kong
Tel: <852> 2265-6688, Fax: <852> 2377-3473

Renesas Technology Taiwan Co., Ltd.
10th Floor, No.99, Fushing North Road, Taipei, Taiwan
Tel: <886> (2) 2715-2888, Fax: <886> (2) 3518-3399

Renesas Technology Singapore Pte. Ltd.
1 Harbour Front Avenue, #06-10, Keppel Bay Tower, Singapore 098632
Tel: <65> 6213-0200, Fax: <65> 6278-8001

Renesas Technology Korea Co., Ltd.
Kukje Center Bldg. 18th Fl., 191, 2-ka, Hangang-ro, Yongsan-ku, Seoul 140-702, Korea
Tel: <82> (2) 796-3115, Fax: <82> (2) 796-2145







Renesas Technology Malaysia Sdn. Bhd
Unit 906, Block B, Menara Amcorp, Amcorp Trade Centre, No.18, Jln Persiaran Barat, 46050 Petaling Jaya, Selangor Darul Ehsan, Malaysia
Tel: <603> 7955-9390, Fax: <603> 7955-9510

Looking for pricing, stock, or lifecycle information?

Click below to explore more details on WIN SOURCE:

-  [View R5F212G6SNFP#W4 on WIN SOURCE](#)
-  [Renesas Electronics America Information](#)

Optimize Your Supply Chain with WIN SOURCE Solutions

-  Global Sourcing Solution
-  Obsolete Management
-  Cost Control Management
-  Shortage Management
-  Alternative Solution
-  Excess Inventory Management