

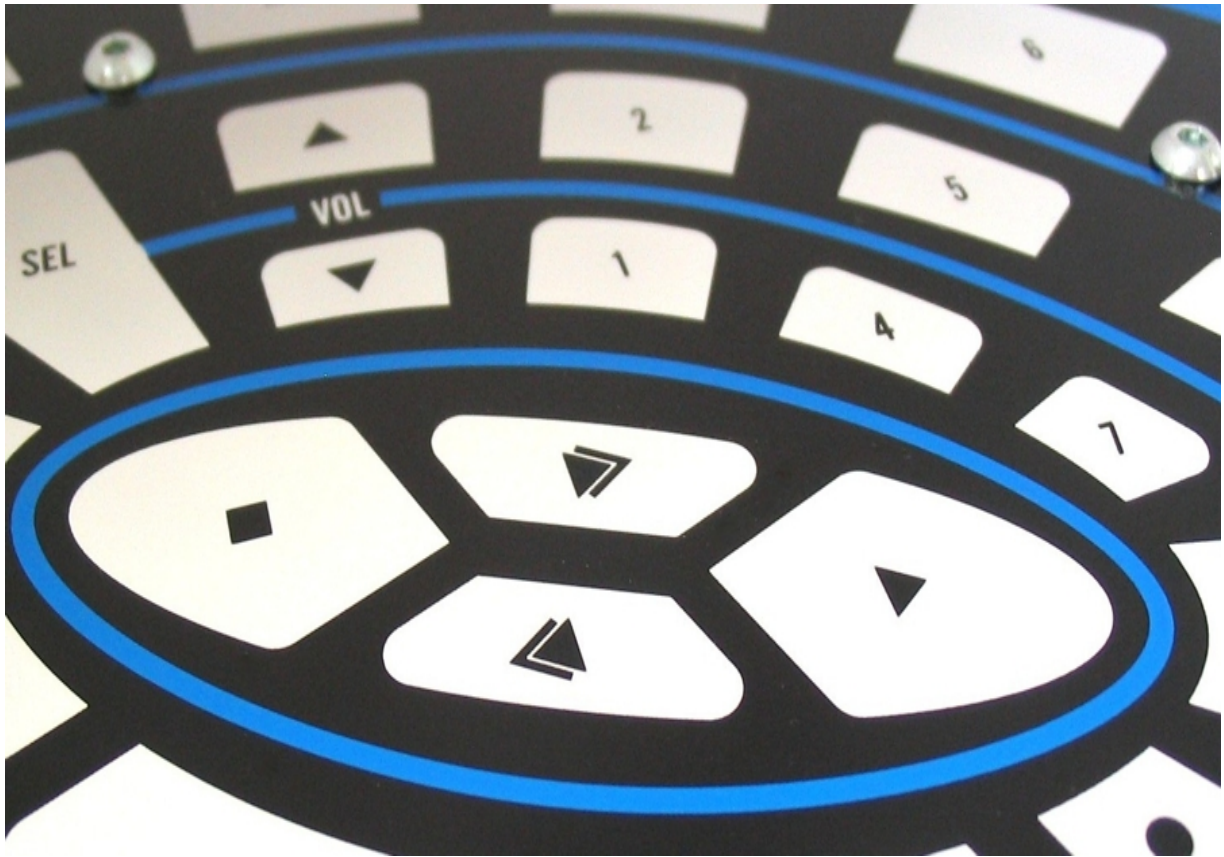

# THE DATASHEET OF E6240





[www.qprox.com](http://www.qprox.com)

# E6240

## User Manual

The New Vision of Touch™

# Contents

<b>1</b>	<b>E6240 Overview</b>	<b>3</b>
1.1	Introduction	3
1.2	Contents of Kit	3
<b>2</b>	<b>Setting Up and Using the E6240</b>	<b>4</b>
2.1	Setting Up	4
2.2	Using the E6240 Assembly	4
<b>3</b>	<b>QmBtn Software</b>	<b>5</b>
3.1	Introduction	5
3.2	QmBtn Dialog Box	5
3.2.1	Introduction	5
3.2.2	Menu Bar	6
3.2.3	Toolbar	8
3.2.4	Keys Area	8
3.2.5	Status Bar	8
3.3	QmSettings Dialog Box	9
3.3.1	Introduction	9
3.3.2	Key Settings	9
3.3.3	Global Settings	10
3.3.4	Logging	11
3.4	QmGraph Dialog Box	11
<b>4</b>	<b>E6240 Assembly Details</b>	<b>12</b>
4.1	Circuit Diagram	12
4.2	E6240 Assembly Components	13
4.2.1	QT60240 IC (U1)	13
4.2.2	Communications Port (J2)	13
4.2.3	USB Connector (J3)	14
4.2.4	LEDs	14
4.2.5	Scope Sync	14
4.2.6	Mains Sync	14
<b>5</b>	<b>Troubleshooting</b>	<b>15</b>

## List of Figures

Figure 1:	E6240 Evaluation Assembly	3
Figure 2:	E6240 Connections	4
Figure 3:	QmBtn Dialog Box	5
Figure 4:	QmBtn Software Menu Structure	6
Figure 5:	QmSettings Dialog Box – Key Settings	9
Figure 6:	QmSettings Dialog Box – Global Settings	10
Figure 7:	QmSettings Dialog Box – Logging	11
Figure 8:	QmGraph Dialog Box	11
Figure 9:	E6240 Circuit Diagram	12
Figure 10:	E6240 Evaluation Assembly	13

## List of Tables

Table 1:	QT6240 IC (32-QFN)	13
Table 2:	Communications Port (J2)	14

# 1 E6240 Overview

## 1.1 Introduction

This kit is designed for the evaluation and development of applications using the QT60160/QT60240 IC. The kit includes an evaluation assembly (E6240 – see *Figure 1*), cables and QmBtn software. Each E6240 assembly has a serial (USB) interface allowing connection to a computer for control and data viewing via QmBtn computer software.

This unique IC allows designers to create controls for various applications such as mobile phones, remote controls and MP3 players, amongst others.

**Refer also to the QT60160/QT60240 datasheet.**

## 1.2 Contents of Kit

1 x E6240 assembly (fitted with a QT60240 IC)

1 x USB-computer cable

2 x sample QT60240 ICs

1 x CD-ROM containing QmBtn software version 3.29 or later, User Manual and other information

**Note:** you will also need:

a computer with Windows 2000, XP or later

a free USB port



*Figure 1: E6240 Evaluation Assembly*

## 2 Setting Up and Using the E6240

### 2.1 Setting Up

To prepare the E6240 for use, proceed as follows:

1. Using the USB cable provided, connect the E6240 to the computer (see *Figure 2*). Both LEDs on the E6240 light constantly to indicate that there is power to the assembly.
2. Install the QmBtn software; either method is acceptable:
  - a. Put the supplied CD in the CD drive of the computer. Copy the contents of the CD to the computer. Double-click the QmBtn software to open it.

**OR**

- b. Go to [www.qprox.com](http://www.qprox.com), point to the **Support** tab and click **Download Archive**. Click **Software** and then the **qmbtn** (version 3.28 or later) link for the E6240. A dialog box appears asking if you want to run or save the file that you are about to download. Click **Run**. This automatically downloads the QmBtn software.

If a dialog box appears saying “The publisher could not be verified. Are you sure you want to run this software?” click **Run**.

3. QmBtn software is displayed on the computer monitor. One LED is extinguished and the other flickers continuously to indicate that the software is communicating with the E6240. Refer to *Section 2.2* and *Section 3* for information about using the E6240 and QmBtn.

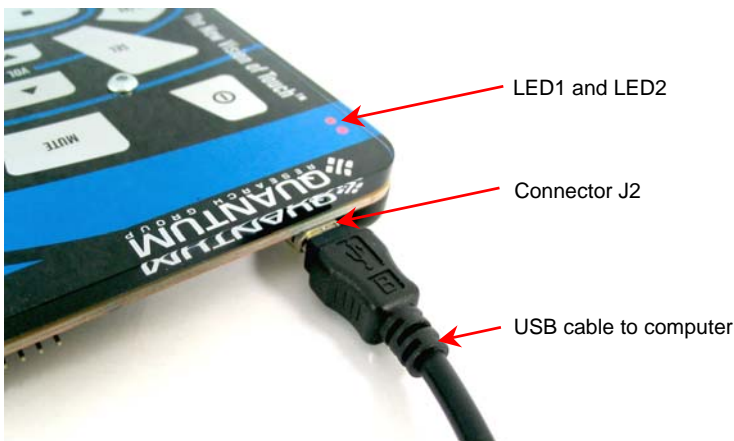

*Figure 2: E6240 Connections*

### 2.2 Using the E6240 Assembly

1. Place the E6240 assembly on a level surface.
2. Keeping clear of the E6240, click **Recall All** on the QmBtn software.
3. Touch any key area on the E6240. Every time a key area is touched the corresponding key area on the QmBtn software turns blue for the duration of the touch.
4. If the QmBtn software is not detecting, or detection is sporadic, decrease the detection threshold slightly (**NTHR**, *Section 3.3.2*, page 9).
5. Refer to *Section 3.3.2*, page 9 and *Section 3.3.3*, page 10 for details of which parameters you can change.

## 3 QmBtn Software

### 3.1 Introduction

QmBtn software is used with the E6240 assembly. With this software you can send commands and monitor signals in real time.

The program consists of three main areas:

- the **QmBtn** dialog box (which opens when the program starts – see *Figure 3, page 5*)
- the **QmSettings** dialog box (which has three tabs, Key Settings, Global Settings and Logging – see *Figure 5, page 9*)
- the **QmGraph** dialog box (which gives real-time signals for individual keys) – see *Figure 8, page 11*

### 3.2 QmBtn Dialog Box

#### 3.2.1 Introduction

The **QmBtn** dialog box provides the ability to monitor the status of all keys and the overall device in real time.

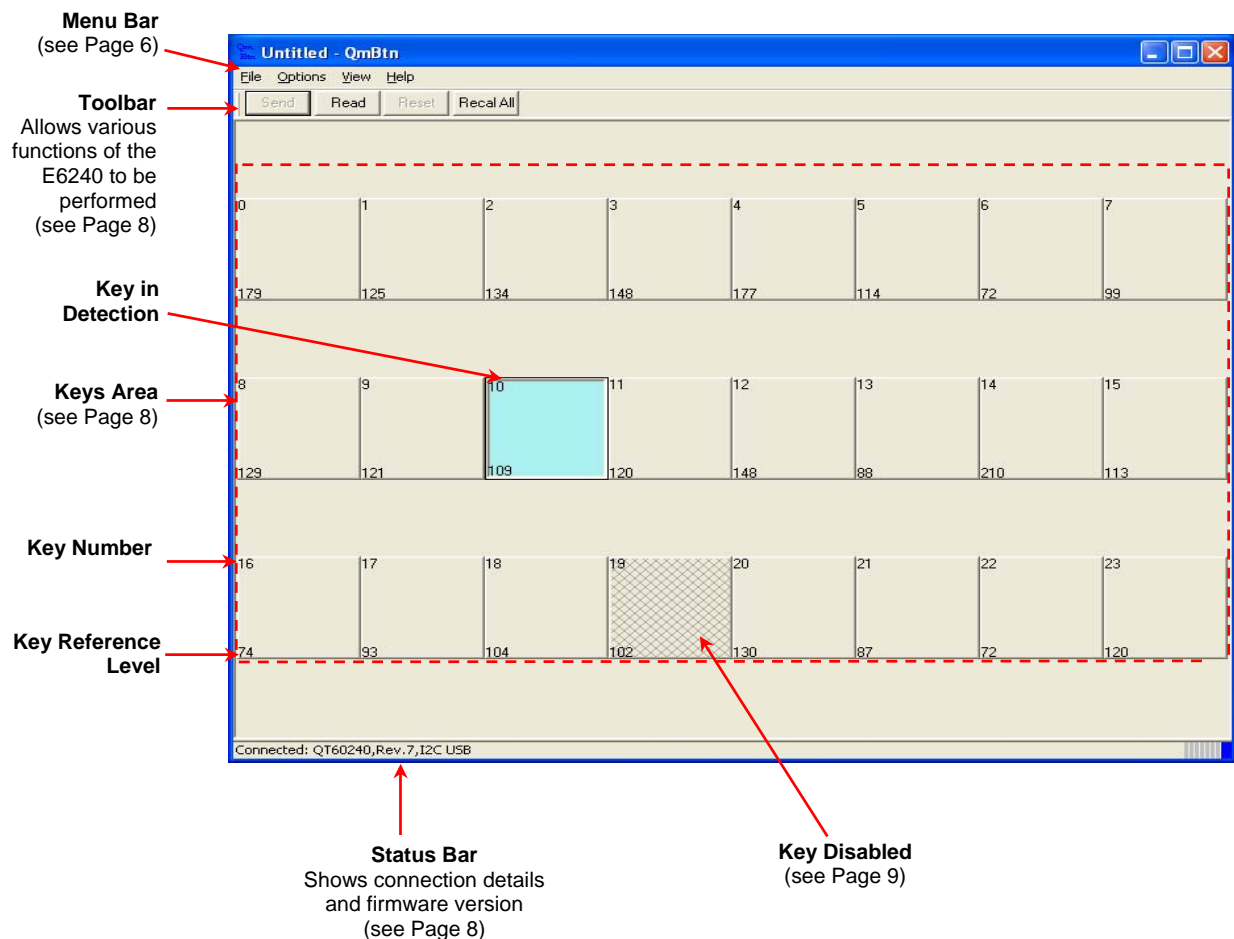

Figure 3: QmBtn Dialog Box

## 3.2.2 Menu Bar

### Menu Structure

Refer to *Figure 3*, page 5 for the location of the Menu bar and *Figure 4* for the menu structure and commands.

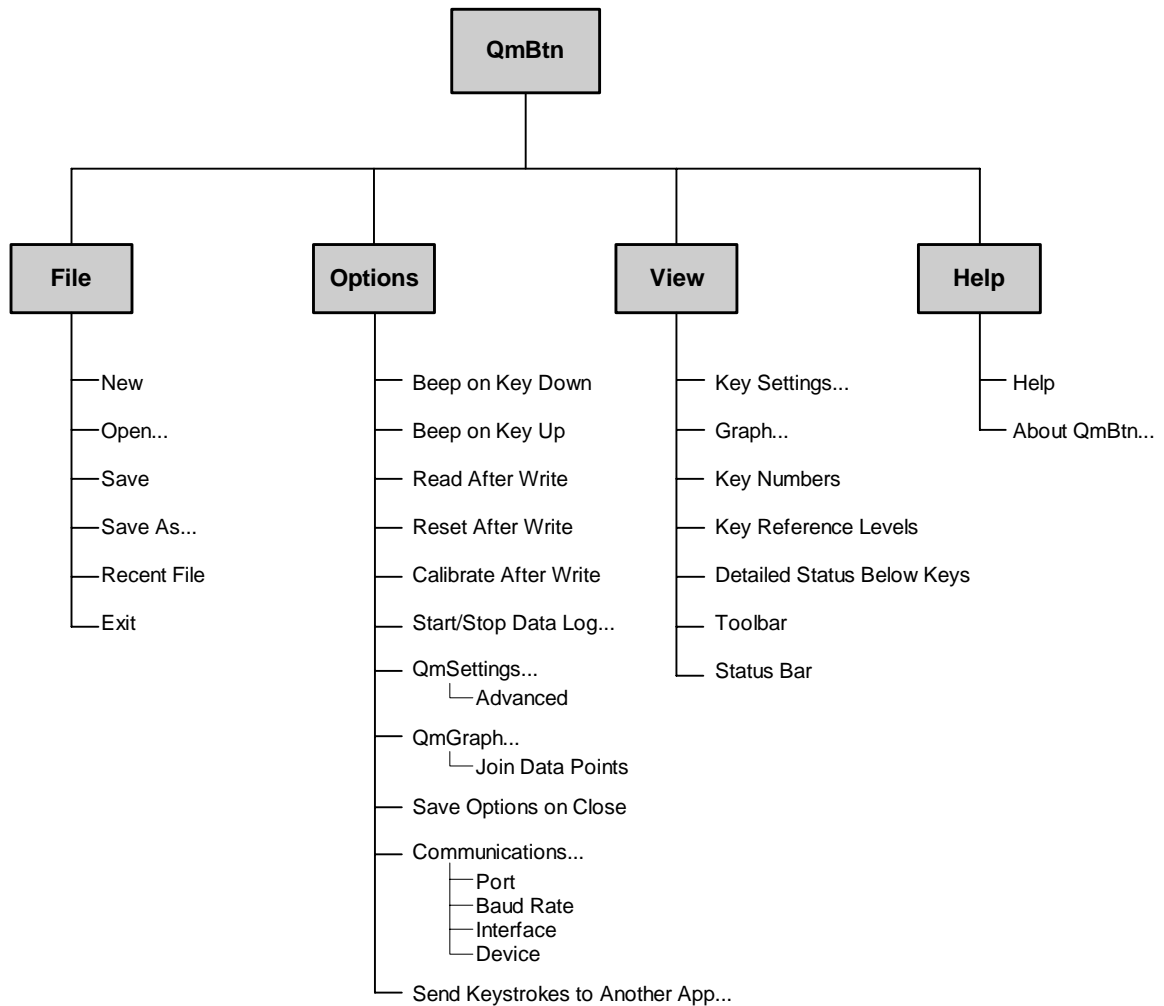

Figure 4: QmBtn Software Menu Structure

### Menu Commands

**File Menu:** Click **File**,

- **New** to create a new file
- **Open** to open a \*.btn file
- **Save** to save the setup of the IC in the current \*.btn file
- **Save As** to save the setup of the IC in a new \*.btn file
- **Recent File** to see a list of the most recently used \*.btn files
- **Exit** to close the QmBtn software

**Options Menu:** Click **Options**,

- **Beep on Key Down** to generate a computer beep on key activation
- **Beep on Key Up** to generate a computer beep on key release
- **Read After Write** to automatically send a read command after sending a new setup block
- **Reset After Write** – not available
- **Calibrate After Write** to automatically send a recalibrate command after sending a new setup block
- **Start/Stop Data Log** to record data into a \*.csv file
- **QmSettings**
  - ✧ **Advanced** to display advanced key settings
- **QmGraph**
  - ✧ **Join Data Points** to draw the graph using a solid line
- **Save Options on Close** to save software settings on closing the software
- **Communications**
  - ✧ **Port** to select the USB/COM port
  - ✧ **Baud Rate** to select the baud rate
  - ✧ **Interface** to select the type of interface
  - ✧ **Device** to select the type of QT device
- **Send Keystrokes to Another Application** to send keystrokes code to another application

**View Menu:** Click **View**,

- **Key Settings** to open the QmSettings dialog box
- **Graph** to open the **QmGraph** dialog box for a particular key (i.e. the last key which was clicked in the software)
- **Key Numbers** to turn the display of key numbers in the **QmBtn** dialog box on/off
- **Key Reference Levels** to turn the display of key reference levels in the **QmBtn** dialog box on/off
- **Detailed Status Below Keys** to turn the display of device status information in the **QmBtn** dialog box on/off
- **Toolbar** to turn the toolbar in the **QmBtn** dialog box on/off
- **Status Bar** to turns the status bar in the **QmBtn** dialog box on/off

**Help Menu:** Click **Help**,

- **Help** to open the Help file
- **About QmBtn** to see details of the copyright and software version

### 3.2.3 Toolbar

The toolbar can be displayed or hidden by use of a command in the **View** menu (see *page 7*). It has the following buttons:

- Click **Send** to transfer a new setup block to the IC
- Click **Read** to obtain the current setup parameters
- **Reset** – not available
- Click **Recal All** to recalibrate all the keys

### 3.2.4 Keys Area

The QT60160 can have a maximum of 16 keys enabled and the QT60240 a maximum of 24 keys enabled. These keys can be anywhere in the 8 x 3 matrix. QmBtn depicts the keys, showing the key numbers and the key reference levels.

If a key area on the E6240 is touched then the corresponding key area on the QmBtn turns blue for the duration of the touch. If a key is disabled the corresponding key area on the QmBtn appears shaded, with a criss-cross pattern (see *Figure 3*).

### 3.2.5 Status Bar

The status bar can be displayed or hidden by use of a command in the **View** menu (see *page 7*). It shows which device is connected to the computer, the IC revision and the type of interface.

## 3.3 QmSettings Dialog Box

### 3.3.1 Introduction

For more information about the parameters refer to the QT60160/QT60240 datasheet. From the Menu bar click **View, Key Settings** to open the **QmSettings** dialog box. This allows the IC to be modified. There are three tabs:

- **Key Settings:** to change the individual key parameters
- **Global Settings:** to change the global parameters
- **Logging:** to select which keys' parameters will be logged

Click here to make changes to all keys

Key number

To select multiple keys, press and hold CTRL and then click the keys. The changes will apply to all selected keys

Key settings (Section 3.3.2)

Value becomes bold when changed

Key Settings (for individual keys)    Global Settings (for all keys)    Logging (for recording data)

(De) select All	NTHR	NDRIFT(s)	PDRIFT(s)	NDIL	FDIL	NRD(s)	BL	AKS	Scope	Sync	WH
Key 0	X0 Y0	12	2.5	0.6	2	5	10.0	64	Off	On	On
Key 1	X1 Y0	11	2.5	0.6	2	5	10.0	32	Off	Off	On
Key 2	X2 Y0	11	2.5	0.6	2	5	10.0	32	Off	Off	On
Key 3	X3 Y0	14	2.5	0.6	2	5	10.0	48	Off	Off	On
Key 4	X4 Y0	14	2.5	0.6	2	5	10.0	64	Off	Off	On
Key 5	X5 Y0	13	2.5	0.6	2	5	10.0	48	Off	Off	On
Key 6	X6 Y0	11	2.5	0.6	2	5	10.0	64	Off	Off	<b>Off</b>
Key 7	X7 Y0	13	2.5	0.6	2	5	10.0	48	Off	Off	On
Key 8	X0 Y1	13	2.5	0.6	2	5	10.0	48	Off	Off	On
Key 9	X1 Y1	12	2.5	0.6	2	5	10.0	48	Off	Off	On
Key 10	X2 Y1	4	2.5	0.6	2	5	10.0	48	Off	Off	On
Key 11	X3 Y1	12	2.5	0.6	2	5	10.0	48	Off	Off	On
Key 12	X4 Y1	13	2.5	0.6	2	5	10.0	48	Off	Off	On
Key 13	X5 Y1	13	2.5	0.6	2	5	10.0	48	Off	Off	On
Key 14	X6 Y1	16	2.5	0.6	2	5	10.0	32	Off	Off	On
Key 15	X7 Y1	15	2.5	0.6	2	5	10.0	48	Off	Off	On
Key 16	X0 Y2	9	2.5	0.6	2	5	10.0	64	Off	Off	On
Key 17	X1 Y2	12	2.5	0.6	2	5	10.0	64	Off	Off	On
Key 18	X2 Y2	11	2.5	0.6	2	5	10.0	48	Off	Off	On
Key 19	X3 Y2	11	2.5	0.6	Key off	5	10.0	64	Off	Off	On
Key 20	X4 Y2	12	2.5	0.6	2	5	10.0	32	Off	Off	On
Key 21	X5 Y2	12	2.5	0.6	2	5	10.0	48	Off	Off	On
Key 22	X6 Y2	11	2.5	0.6	2	5	10.0	64	Off	Off	On
Key 23	X7 Y2	11	2.5	0.6	2	5	10.0	48	Off	Off	On

Figure 5: QmSettings Dialog Box – Key Settings

### 3.3.2 Key Settings

If the dialog box does not open in the Key Settings view then click the **Key Settings** tab (see Figure 5). The default settings show NTHR and BL (with no tabs at the bottom of the dialog box). To see the full list of settings and the tabs click **Options, QmSettings, Advanced**.

**NTHR – Negative Threshold** is used to adjust the sensitivity of a key. Higher values make keys less sensitive, lower values make keys more sensitive.

**NDRIFT – Negative Drift** is the rate at which drift compensation is carried out for a negative going signal (when a key is touched or receives increased loading). The value is seconds/reference level.

**PDRIFT – Positive Drift** is the rate at which drift compensation is carried out for a positive going signal (when a key is touched or receives increased loading). The value is seconds/reference level.

**NDIL – Negative Detection Integrator Limit** allows enabling and disabling of keys and provides signal filtering. Higher values provide more filtering but increase the response time of the key.

**FDIL – Fast Detection Integrator Limit** provides filtering but has less effect on response time. Total filtering is a combination of NDIL multiplied by FDIL.

**NRD – Negative Recalibration Delay** determines the maximum time a key can be active before being automatically recalibrated by the IC. The value is in seconds.

**BL – Burst Length** modifies key sensitivity. Higher values make the key more sensitive, lower values make it less sensitive. The correct sensitivity for a key should be achieved with BL and NTHR. Generally, BL should be as low as possible and NTHR should range from 7 to 12.

**AKS – Adjacent Key Suppression** can be enabled or disabled. To become active, a key with this option enabled must receive the strongest signal relative to other AKS-enabled keys.

**Scope Sync** – sends a positive pulse that brackets the burst of a selected key. This feature is invaluable for diagnostics.

**WH – Wake** allows the device to be configured to wake up when specific keys are touched. Each key has its own configuration bit so that any combination of keys can be configured for this purpose.

### 3.3.3 Global Settings

If the dialog box does not open in the Global Settings view then click the **Global Settings** tab (see *Figure 6*).

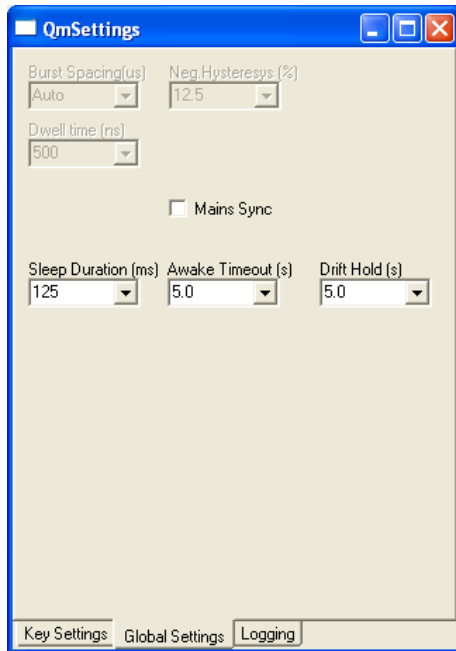

*Figure 6: QmSettings Dialog Box – Global Settings*

**Mains Sync** – allows the part to synchronise on the low frequency signal. This is generally used to synchronise acquisition on the mains cycle (50/60Hz). The frequency must be more than 10Hz.

**Sleep Duration** – defines the length of time the device will sleep before automatically waking up and returning to sleep.

**Awake Timeout** – defines the minimum amount of time the part will stay awake after a communication or after a valid key press woke it up.

**Drift Hold** – defines the time the drift on the reference is held after a key is touched. This affects all the keys. If set to Off all keys drift regardless of the state of other keys.

### 3.3.4 Logging

These settings have no effect on the IC. They define which data will be recorded when using the Data Logger. For any key(s), select any combination of Signal, Reference, DI and Status. The selected readings are recorded in a \*.csv file.

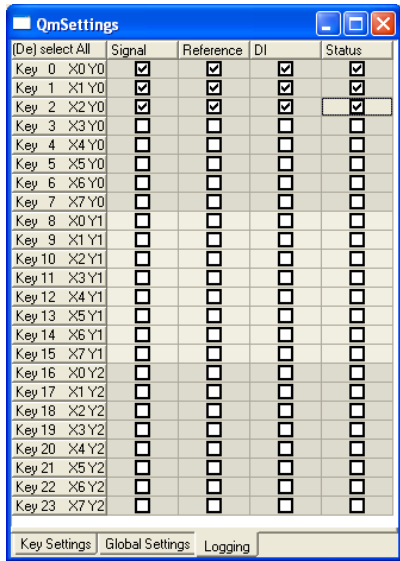

Figure 7: QmSettings Dialog Box – Logging

### 3.4 QmGraph Dialog Box

From the Menu bar click **View, Key Settings** to open the **QmGraph** dialog box. This displays the analog signal for a selected key.

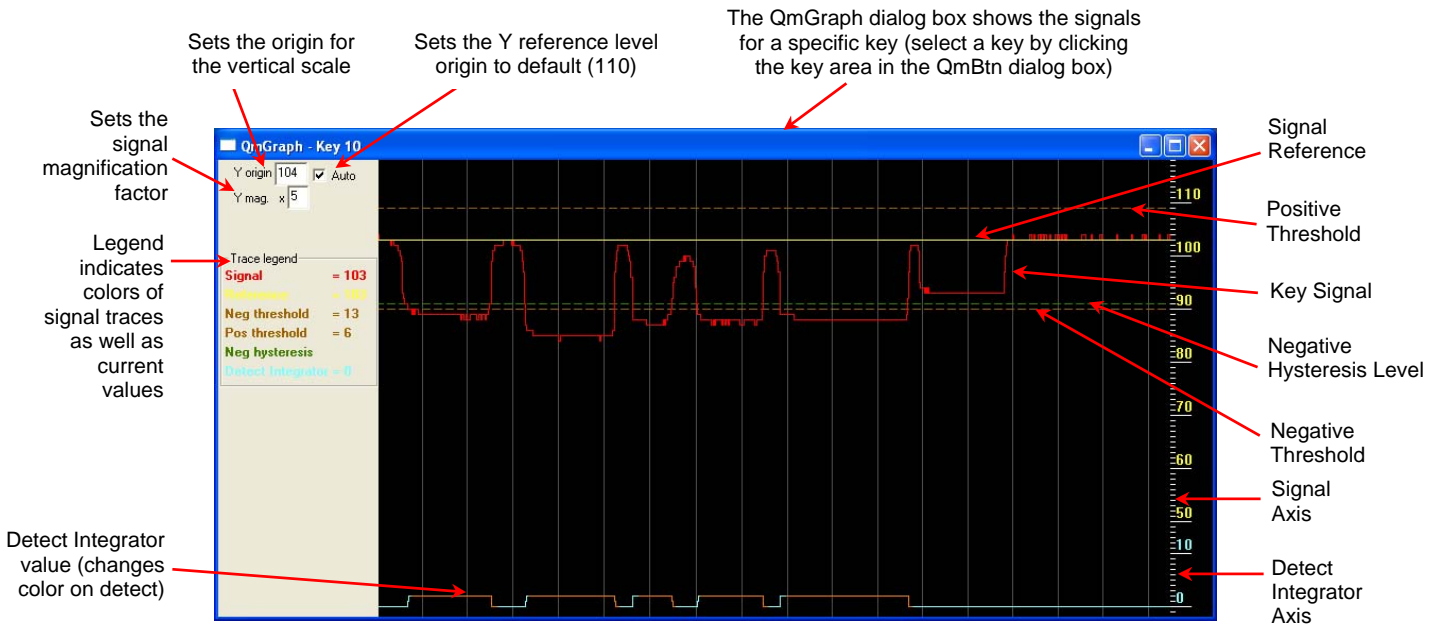

Figure 8: QmGraph Dialog Box

Click the right mouse button to see a shortcut menu with the following options:

- **Join Data Points** – shows the signal using a solid line
- **Show Grid every Second** – shows a vertical grid, every second

# 4 E6240 Assembly Details

## 4.1 Circuit Diagram

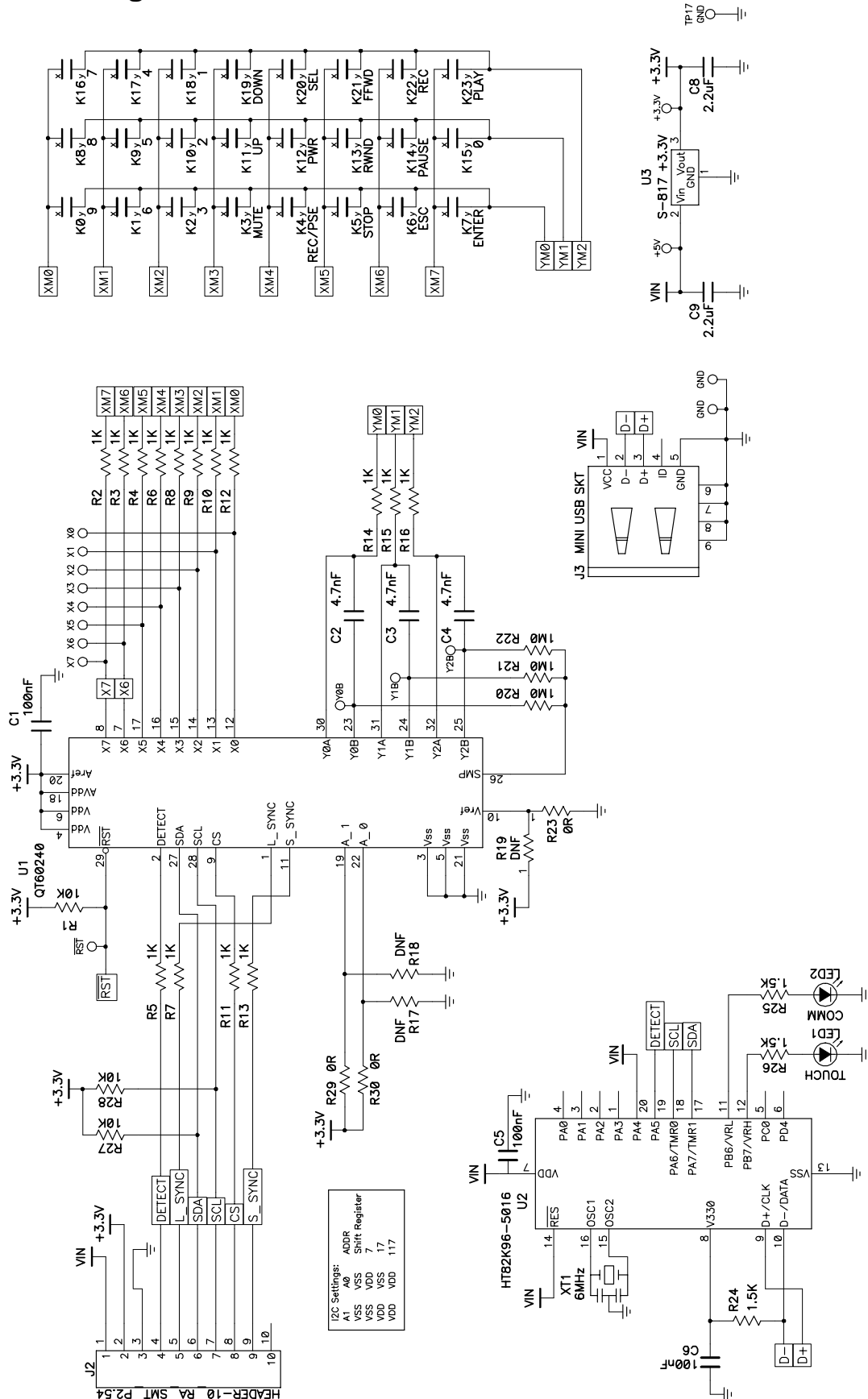

Figure 9: E6240 Circuit Diagram

## 4.2 E6240 Assembly Components

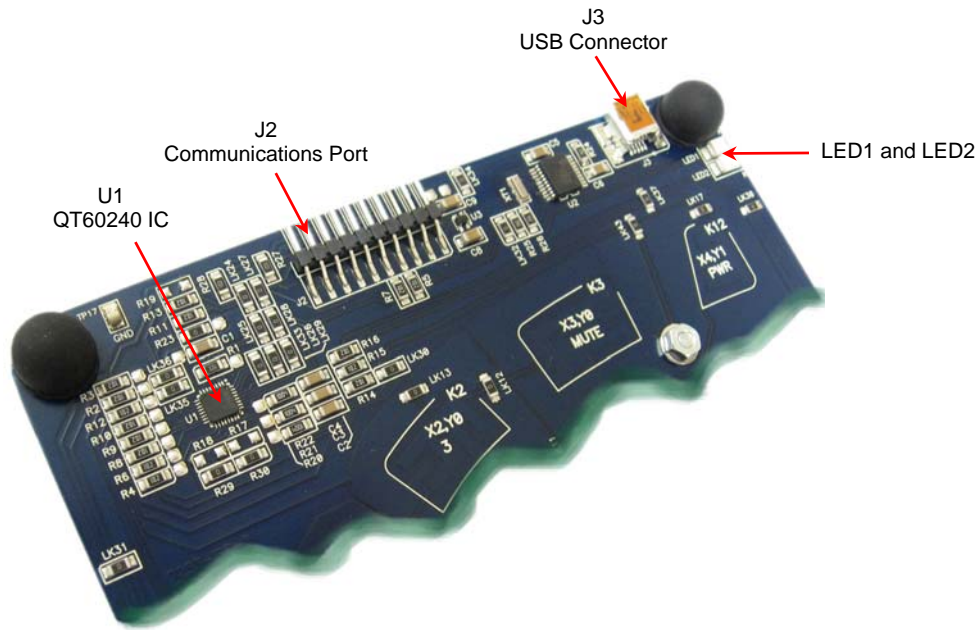

Figure 10: E6240 Evaluation Assembly

### 4.2.1 QT60240 IC (U1)

Table 1: QT60240 IC (32-QFN)

Pin	Name	Pin	Name
1	M_SYNC	17	X5
2	CHANGE	18	Vdd
3	Vss	19	A1
4	Vdd	20	Vdd
5	Vss	21	Vss
6	Vdd	22	A0
7	X6	23	Y0B
8	X7	24	Y1B
9	LATCH	25	Y2B
10	Vref	26	SMP
11	S_SYNC	27	SDA
12	X0	28	SCL
13	X1	29	/RST
14	X2	30	Y0A
15	X3	31	Y1A
16	X4	32	Y2A

### 4.2.2 Communications Port (J2)

Header J2 gives access to all the signals for communicating with the IC. See *Table 2* for the pinouts of the connector.

Table 2: Communications Port (J2)

Pin	1	2	3	4	5	6	7	8	9	10
Name	Vin +5V	+3.3V	GND	CHANGE	MAINS SYNC	SDA	SCL	LATCH	SCOPE SYNC	N/C

### 4.2.3 USB Connector (J3)

This connector provides direct communication between the E6240 and the computer. It permits full control over the device including calibration and setups. It also allows for real-time supervision of signal, reference and calibration information. It uses a standard USB cable (supplied) connected to a computer.

### 4.2.4 LEDs

Before the QmBtn software is running, both LED1 and LED2 will be on constantly, to indicate that the E6240 is connected to the computer and has power (see *Figure 10*). Once the QmBtn software is running, LED1 is extinguished and LED2 flickers continuously to indicate that the software is communicating with the E6240. LED1 will turn on any time there is a change of state on the keypad.

### 4.2.5 Scope Sync

The scope sync (J2, pin 9) can be used to synchronize an oscilloscope. When enabled in QmBtn, this signal provides a pulse that brackets the chosen burst or bursts, making diagnostics much simpler. With the scope sync enabled for one key, the X matrix drive signals can be clearly seen.

### 4.2.6 Mains Sync

For external noise sync feed a +3.3V synchronization pulse into pin 5 of J2 with respect to GND. External fields can cause interference leading to false detections or sensitivity shifts. Most fields come from AC power sources. RFI noise sources are heavily suppressed by the low impedance nature of the QT circuitry itself. Noise, such as from 50Hz or 60Hz fields becomes a problem if it is uncorrelated with acquisition signal sampling; uncorrelated noise can cause aliasing effects in the key signals. To suppress this problem the M\_SYNC input allows bursts to synchronize to the noise source.

## 5 Troubleshooting

Problem	Potential Cause and Solution
<p><b>Software will not communicate with computer</b></p>	<p>▶ <b>Bad I<sup>2</sup>C or USB connection</b></p> <p>Check that the USB cables are connected properly. Check/replace cables. Ensure that the E6240 assembly is getting power and the LEDs are on. Ensure that all communications options are on the correct settings. Either set all to Auto Detect or:</p> <ul style="list-style-type: none"> <li>● Device = QT60240 (see <i>page 7</i>)</li> <li>● Interface = I<sup>2</sup>C (see <i>page 7</i>)</li> <li>● Port = USB (see <i>page 7</i>)</li> </ul>
<p><b>Noisy or erratic signal</b></p>	<p>▶ <b>Noisy power supply</b> Try a different USB port or computer.</p> <p>▶ <b>Cables or E6240 assembly too close to strong noise source</b> (such as a power line or switching noise source) Increase the distance between the E6240 assembly and the noise source. Place a grounded metal shield between the noise source and the E6240 assembly.</p> <p>▶ <b>E6240 assembly is not mechanically stable</b> Prevent E6240 assembly from moving around.</p> <p>▶ <b>Strong RFI from a transmitter or adjacent digital product</b> Remove the noise source or shield against it.</p> <p>▶ <b>USB cable connected via a USB hub</b> Connect the USB cable directly to the computer.</p>

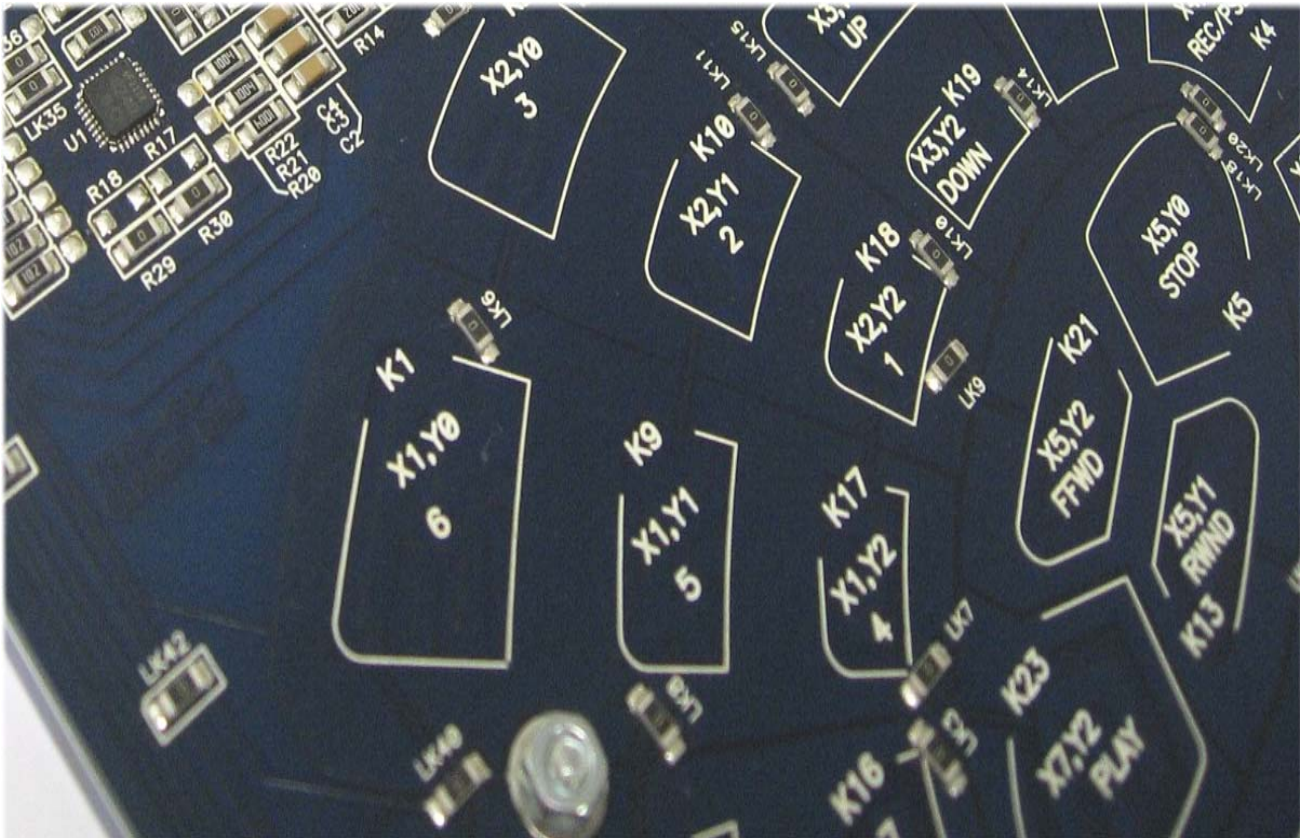

 **QUANTUM**  
RESEARCH GROUP  
www.qprox.com

**Corporate Headquarters**

1 Mitchell Point  
Ensign Way, Hamble  
Southampton SO31 4RF  
United Kingdom

Tel +44 (0)23 8056 5600  
Fax +44 (0)23 8045 3939

Copyright © 2006-2007 QRG Ltd  
All rights reserved  
Patented and patents pending

**Development Team**

*Samuel Brunet, Dr. Tim Ingersoll,  
Matthew Trend*

**North America**

651 Holiday Drive Bldg. 5 / 300  
Pittsburgh, PA 15220  
USA

Tel 412-391-7367  
Fax 412-291-1015

**REV 102.0407**

## Looking for pricing, stock, or lifecycle information?

Click below to explore more details on WIN SOURCE:

- [View E6240 on WIN SOURCE](#)
- [Microchip Technology Information](#)

## Optimize Your Supply Chain with WIN SOURCE Solutions

- ✓ Global Sourcing Solution
- ✓ Obsolete Management
- ✓ Cost Control Management
- ✓ Shortage Management
- ✓ Alternative Solution
- ✓ Excess Inventory Management