



**THE DATASHEET OF
PEF 3394 HL V2.2**



VINETIC

Enhanced Next Generation
Analog Telephony Solutions
PEB/PEF 33xx



INFINEON's VINETIC family of analog voice access ICs includes two, four and eight-channel codecs that are optimized for Customer Premises Equipment (CPE) as well as Central Office (CO) access network applications.

FEATURING FOUR levels of integrated DSP performance, the VINETIC offers system providers a wide range of flexible solutions from pure TDM functionality, up to full blown VoIP or VoATM packet and voice processing engines.

WITH THIS comprehensive set of specially designed packet based voice transmission features, the VINETIC provides the DSP power required for each specific application.

TOGETHER with Infineon's extended family of SLIC devices, each system can be tailored with an optimum combination of devices.

Applications

- Residential Gateways, VoIP Routers, ATAs
- Integrated Access Devices (IAD)
- Cable Modems, eMTAs, SMTAs
- Access Network, DLC, Central Office, WLL, FTTH, DSLAMs
- PBX, VoIP-PBX

Voice over Packet Features

- ATM AAL2 and RTP packetization including fixed and adaptive Jitter Buffer up to 200 ms for optimum voice quality
- Integrated Voice Compression supports G.728, G.723.1, G.729 A/B/E, G.726 ADPCM (32, 16, 24, 40 kbit/s) and G.711, iLBC royalty free vocoder in preparation
- Patent indemnification for Vocoder Algorithms available
- T.38 Fax Relay Support including V.17/V.21/V.27ter/V.29
- Line Echo Cancellation (LEC) supports Near and Far-End-Echo with up to a 128 ms tail, and exceeds G.165 / G.168 / G.168-2000 / G.168-2002
- DSP power according to system port density
- Encapsulated Voice Processing takes care of all real-time-critical tasks within VINETIC
- Advanced Integrated Test and Diagnostic Functions (AITDF) support Line Testing and Quality of Service (QoS)

Codec/SLIC Features

- Fully programmable 2, 4, and 8-channel CODEC with voice processing DSP
- HW and SW compatible
- Specification according to ITU-T Q.552, G.712, LSSGR
- Uses Infineon's well-known SLIC family
- AC and DC characteristic country independent programmable
- Enhanced Power Management
- Integrated DTMF Receiver
- Integrated Caller-ID Generator and Detector (FSK and DTMF)
- Internal programmable balanced ringing up to 85 V_{RMS} and 50 V_{RMS} unbalanced ringing
- Support of external ringing
- Metering pulse up to 2.5 V_{RMS} at 200 Ω (12 / 16 kHz)

Documentation and Development Tools

- Evaluation board EASY334 + VINETIC Tool CD-ROM
- EASY5120PS-ATA VoIP Router reference design
- EASY50510 ADSL CPE reference design
- WildPass - Wireless VoIP reference design
- Cost efficient Calculation Soft-Ware (VINETICOS)
- Data sheets, System and Soft-Ware User's Guides and Application Notes

www.infineon.com/vinetic

Wireline Communications



Never stop thinking.

VINETIC Family – Overview

Chip Set ¹⁾	VINETIC-4 VIP	VINETIC-2 CPE	VINETIC-o	VINETIC-4 M	VINETIC-4 C	VINETIC-4 S
Sales Codes: P-LBGA-176-3 P/PG-LQFP-176-2 P/PG-LBGA-144-1	PEB 3324 E PEB 3324 HL PEB 3324 EL ²⁾	PEB 3332 EL	PEB 3320 E PEB 3320 HL	PEF 3314 E PEF 3314 HL PEF 3314 EL ²⁾	PEF 3394 E PEF 3394 HL PEF 3394 EL ²⁾	PEF 3304 E PEF 3304 HL PEF 3304 EL ²⁾
Analog Channels	4	2	0	4	4	4
Supported SLICs	SLIC-P (PEB 4266), SLIC-E (PEB 4265), SLIC-E2 (PEB 4265-2), SLIC-S (PEB 4264), SLIC-S2 (PEB 4264-2), TSLIC-E (PEB 4365), TSLIC-S (PEB 4364), SLIC-LCP (PEB 4262), SLIC-DC (PEF 4268)					
Echo Cancellation (G.165 / G.168)	Up to 128 ms	Up to 16 ms	Up to 128 ms	Up to 16 ms	Up to 16 ms	No
ADPCM (G.726)	Yes	Yes	Yes	Yes	Yes	No
Complex Voice Codecs (G.723, G.729, G.728) ³⁾	Yes	Yes	Yes	No	No	No
Fax Relay T.38	Yes	Yes	Yes	No	No	No
iLBC (Royalty free vocoder)	In preparation	In preparation	In preparation	No	No	No
DTMF Receiver, Caller-ID Rcv and Send, Tones	Yes	Yes	Yes	Yes	Yes	No
AAL2 / RTP Packetization / Jitter Buffer	Yes	Yes ⁴⁾	Yes	Yes	No	No
Simultaneous VoCoders	4	4	4	4	N/a	N/a
External RAM Required	No	No	No	No	No	No
Integrated Code RAM for Firmware Download	Yes	No	Yes	No	No	No
Line Testing AITDF	Yes	GR-909	Yes	Yes	Yes	Yes

1) For more members of the VINETIC family contact Infineon sales for more details on VINETIC. VINETIC devices offer pin- and SW-compatible versions

2) Version 2.1 and higher only

3) Patent Indemnification available from Infineon

4) RTP only supported

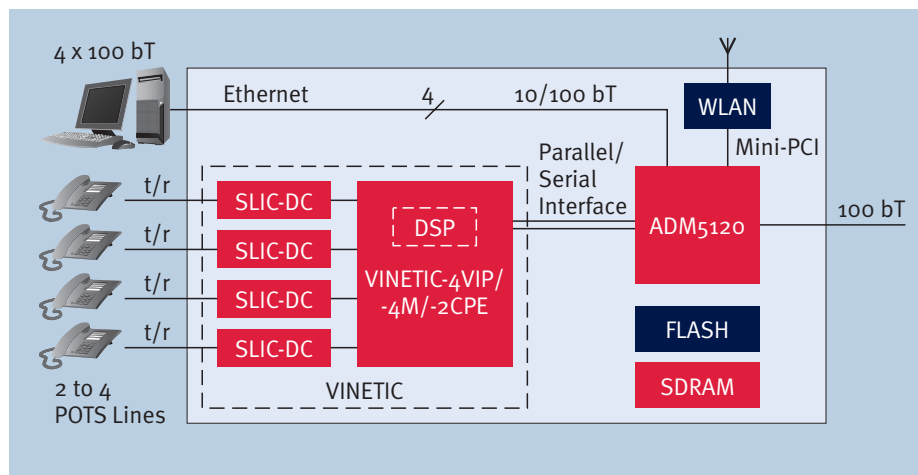

VoIP Router and ATA
Application Example for
One Hardware for All
„Voice over Packet“ Applications

How to reach us:
<http://www.infineon.com>

Published by
Infineon Technologies AG
St.-Martin-Strasse 53
81669 München

© Infineon Technologies AG 2004.
All Rights Reserved.

Template: pb_w_tmplt.fm/2

Attention please!

The information herein is given to describe certain components and shall not be considered as a guarantee of characteristics. Terms of delivery and rights to technical change reserved.

We hereby disclaim any and all warranties, including but not limited to warranties of non-infringement, regarding circuits, descriptions and charts stated herein.

Information

For further information on technology, delivery terms and conditions and prices please contact your nearest Infineon Technologies Office.

Warnings

Due to technical requirements components may contain dangerous substances. For information on the types in question please contact your nearest Infineon Technologies Office.

Infineon Technologies Components may only be used in life-support devices or systems with the express written approval of Infineon Technologies, if a failure of such components can reasonably be expected to cause the failure of that life-support device or system, or to affect the safety or effectiveness of that device or system. Life support devices or systems are intended to be implanted in the human body, or to support and/or maintain and sustain and/or protect human life. If they fail, it is reasonable to assume that the health of the user or other persons may be endangered.

Looking for pricing, stock, or lifecycle information?

Click below to explore more details on WIN SOURCE:

-  [View PEF 3394 HL V2.2 on WIN SOURCE](#)
-  [Infineon Technologies Information](#)

Optimize Your Supply Chain with WIN SOURCE Solutions

-  Global Sourcing Solution
-  Obsolete Management
-  Cost Control Management
-  Shortage Management
-  Alternative Solution
-  Excess Inventory Management