



**THE DATASHEET OF
IPC-7132BP-00XE**



IPC-7132

Cost-effective Wallmount Chassis for ATX/mATX Motherboard and 10-slot Backplane



Features

- Support ATX/mATX M/B and 10-slot PICMG 1.3 backplane
- Shockproof drive bay for one 5.25" ODD and three 3.5" HDDs
- Thumb-screw for top cover easy opening
- Bidirectional option to mount chassis on wall or workbench
- Two front access USB ports

CE FCC

Specifications

| | | External | Internal |
|--------------------------|------------------------|--|--|
| Disk Drive Bay | 3.5" | 1 | 2 |
| | 5.25" | 1 | - |
| Cooling | Fan | 1 (12 cm/85 CFM) | |
| | Air Filters | Yes | |
| Front I/O interface | USB 2.0 | 2 | |
| Miscellaneous | LED Indicators | Power, HDD | |
| | Control | Power Switch, System Reset Button | |
| | Rear panel | 4x USB, 2x DB-9, 1x LPT port | |
| Environment | Temperature | Operating 0 ~ 40° C (32 ~ 104° F) | Non-operating -20 ~ 60° C (-4 ~ 140° F) |
| | Humidity | 10 ~ 85 % @ 40° C, non-condensing | |
| | Vibration (5-500 Hz) | 1 Grms | |
| | Shock | 10 G (with 11 ms duration, half sine wave) | |
| | Dimensions (W x H x D) | 200 x 330 x 430 mm (7.9" x 13" x 16.9") | |
| Physical Characteristics | Weight | 9.96 kg (21.93 lb) | |

Front View

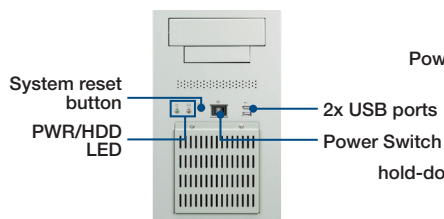

Inside View

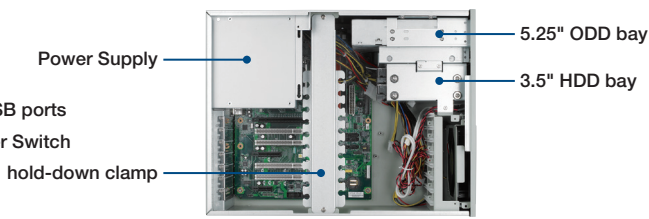

IPC-7132MB

Rear View

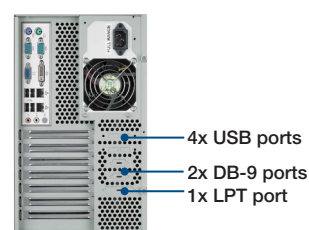

IPC-7132MB



Easy-to-maintain cooling fan

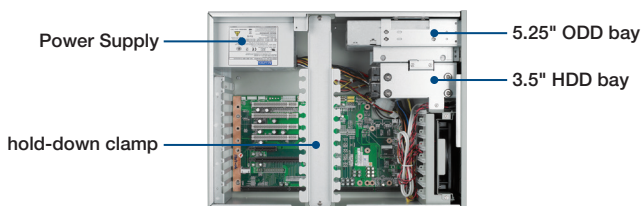

IPC-7132BP

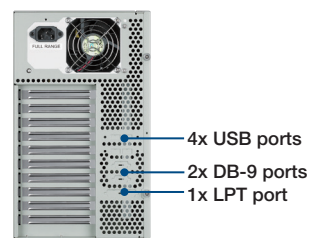

IPC-7132BP

Dimensions

Unit: mm [inch]

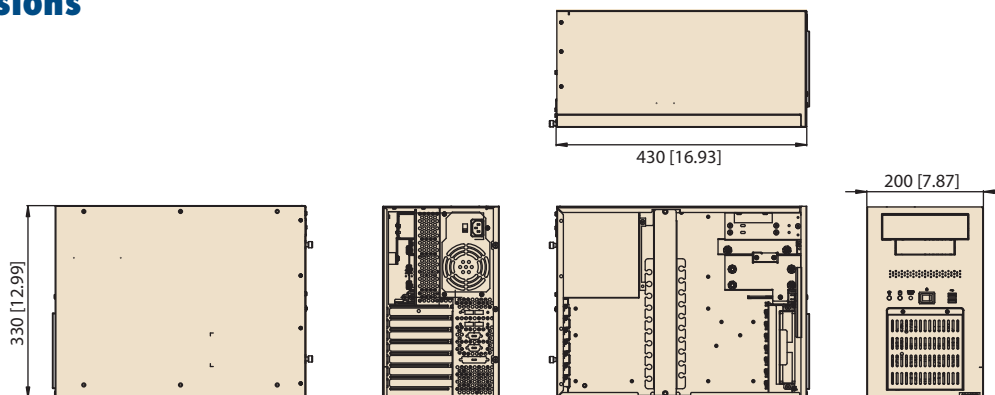

Installation

Unit: mm [inch]

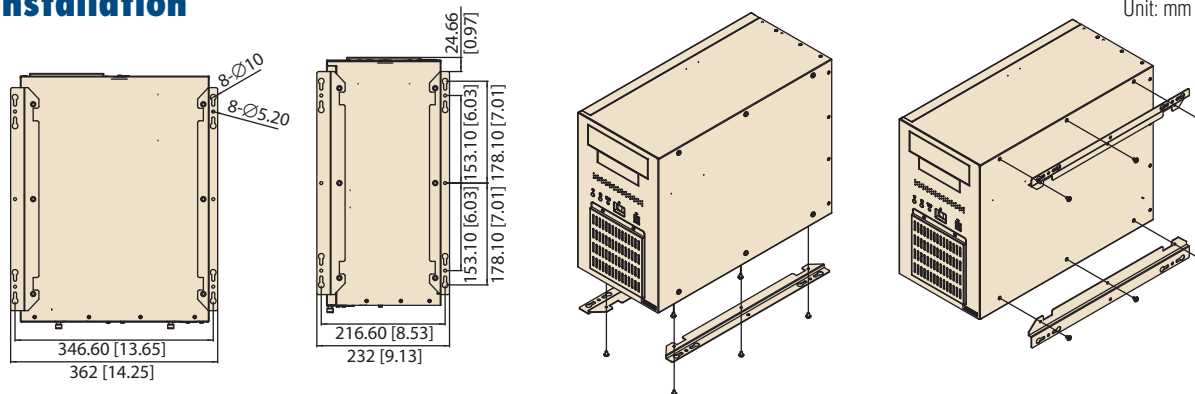

Ordering Information

| Model Name | Power supply | Wattage | Switch Type |
|----------------------------|---------------|---------|-------------|
| Motherboard Version | | | |
| IPC-7132MB-00XE | - | - | ATX |
| IPC-7132MB-25ZE | 96PS-A250WPS2 | 250W | ATX |
| IPC-7132MB-30ZE | 96PS-A300WPS2 | 300W | ATX |
| IPC-7132MB-40ZE | 96PS-A400WPS2 | 400W | ATX |
| Backplane Version | | | |
| IPC-7132BP-00XE | - | - | ATX |

Optional Accessories

| Part Number | Description |
|--------------|---|
| IPC-DT-3120E | Mobile HDD tray for dual 2.5" SATA HDDs |
| 1750006427 | 87.87 CFM, system fan 120 x 120 x 25.0 mm |

Backplane Options

| Model | PICMG 1.3 | PCIe | PCI-X | PCI |
|----------------|-----------|-------------|-------|-----|
| PCE-5B09-06A1E | PICMG 1.3 | 1 (PCIe x4) | - | 6 |
| PCE-5B09-04A1E | PICMG 1.3 | 3 (PCIe x4) | - | 4 |

Looking for pricing, stock, or lifecycle information?

Click below to explore more details on WIN SOURCE:

 [View IPC-7132BP-00XE on WIN SOURCE](#)

 [Advantech Corp Information](#)

Optimize Your Supply Chain with WIN SOURCE Solutions

-  Global Sourcing Solution
-  Obsolete Management
-  Cost Control Management
-  Shortage Management
-  Alternative Solution
-  Excess Inventory Management