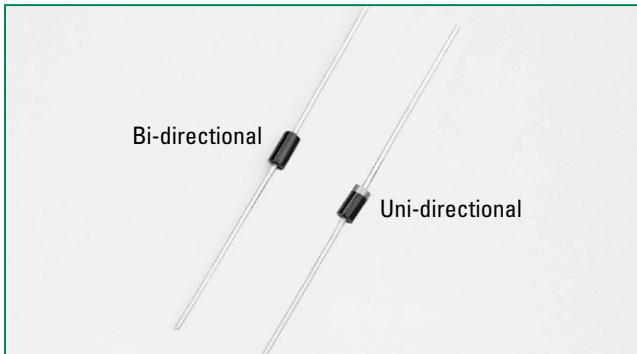





# THE DATASHEET OF P4KE75CA



### P4KE Series



#### Agency Approvals

AGENCY	AGENCY FILE NUMBER
	E230531

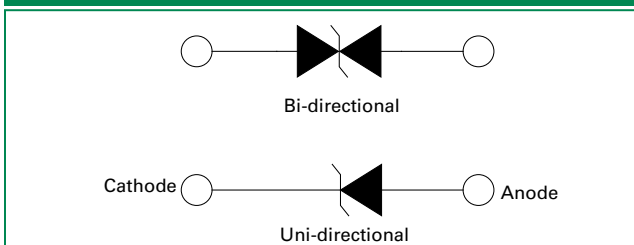
#### Maximum Ratings and Thermal Characteristics (T<sub>A</sub> = 25°C unless otherwise noted)

Parameter	Symbol	Value	Unit
Peak Pulse Power Dissipation (Fig.2) by 10/1000µs Test Waveform (Fig.4) (Note 1), (Note 4)	P <sub>PPM</sub>	400	W
Steady State Power Dissipation on Infinite Heat Sink at T <sub>L</sub> = 75°C	P <sub>D</sub>	1.5	W
Peak Forward Surge Current, 8.3ms Single Half Sine Wave Unidirectional Only (Note 2)	I <sub>FSM</sub>	60	A
Maximum Instantaneous Forward Voltage at 25A for Unidirectional Only (Note 3)	V <sub>F</sub>	3.5/5.0	V
Operating Junction and Storage Temperature Range	T <sub>J</sub> , T <sub>STG</sub>	-55 to 175	°C
Typical Thermal Resistance Junction to Lead	R <sub>θJL</sub>	60	°C/W
Typical Thermal Resistance Junction to Ambient	R <sub>θJA</sub>	100	°C/W

#### Notes:

1. Non-repetitive current pulse, per Fig. 4 and derated above T<sub>J</sub> (initial) = 25°C per Fig. 3.
2. Measured on 8.3ms single half sine wave or equivalent square wave, duty cycle = 4 per minute maximum.
3. V<sub>F</sub> < 3.5V for single die parts and V<sub>F</sub> < 5.0V for stacked-die parts.
4. The P<sub>PPM</sub> of stacked-die parts is 600W, please contact Littelfuse for the stacked-die component details.

#### Functional Diagram



#### Description

The P4KE Series is designed specifically to protect sensitive electronic equipment from EFTs, ESD, and induced lightning transients.

#### Features

- 400W peak pulse capability at 10/1000µs waveform, repetition rate (duty cycles): 0.01%
- Glass passivated chip junction in DO-41 Package
- Fast response time: typically less than 1.0ps from 0 Volts to V<sub>BR min</sub>
- Excellent clamping capability
- Typical failure mode is a short circuit
- Whisker test is conducted per Table 4a/4c of JEDEC JESD201A
- IEC 61000-4-2 ESD 30kV(Air), 30kV (Contact)
- EFT protection of data lines in accordance with IEC 61000-4-4
- Low incremental surge resistance
- Typical IR ≤ 1 µA for VBR min > 12.6 V
- High temperature reflow soldering guaranteed: 260°C/40sec / 0.375"/(9.5mm) lead length, 5 lbs., (2.3kg) tension
- V<sub>BR</sub> @ T<sub>J</sub> = V<sub>BR</sub> @ 25°C × (1 + α T × (T<sub>J</sub> - 25)) (α T: Temperature Coefficient, typical value is 0.1%)
- UL Recognized compound meeting flammability rating V-0
- Halogen free and RoHS compliant
- Pb-free E3 means 2nd level interconnect is Pb-free and the terminal finish material is tin(Sn) (IPC/JEDEC J-STD-609A.01)

#### Applications

TVS components are ideal for the protection of I/O interfaces, V<sub>CC</sub> bus and other vulnerable circuits used in telecom, computer, industrial ICT equipment and consumer electronic applications.

#### Additional Information



Datasheet




Resources



Samples

### Electrical Characteristics (T<sub>A</sub>=25°C unless otherwise noted)

Part Number (Uni)	Part Number (Bi)	Reverse Stand off Voltage V <sub>R</sub> (Volts)	Breakdown Voltage V <sub>BR</sub> @ I <sub>T</sub> (V)		Test Current I <sub>T</sub> (mA)	Maximum Clamping Voltage V <sub>C</sub> @ I <sub>pp</sub> (V)	Maximum Peak Pulse Current I <sub>pp</sub> (A)	Maximum Reverse Leakage I <sub>R</sub> @ V <sub>R</sub> (μA)	Agency Approval 
			MIN	MAX					
P4KE6.8A	P4KE6.8CA	5.80	6.45	7.14	10	10.5	39.00	1000	X
P4KE7.5A	P4KE7.5CA	6.40	7.13	7.88	10	11.3	36.30	500	X
P4KE8.2A	P4KE8.2CA	7.02	7.79	8.61	10	12.1	33.90	200	X
P4KE9.1A	P4KE9.1CA	7.78	8.65	9.55	1	13.4	30.60	50	X
P4KE10A	P4KE10CA	8.55	9.50	10.50	1	14.5	28.30	10	X
P4KE11A	P4KE11CA	9.40	10.50	11.60	1	15.6	26.30	5	X
P4KE12A	P4KE12CA	10.20	11.40	12.60	1	16.7	24.60	5	X
P4KE13A	P4KE13CA	11.10	12.40	13.70	1	18.2	22.50	1	X
P4KE15A	P4KE15CA	12.80	14.30	15.80	1	21.2	19.30	1	X
P4KE16A	P4KE16CA	13.60	15.20	16.80	1	22.5	18.20	1	X
P4KE18A	P4KE18CA	15.30	17.10	18.90	1	25.5	16.10	1	X
P4KE20A	P4KE20CA	17.10	19.00	21.00	1	27.7	14.80	1	X
P4KE22A	P4KE22CA	18.80	20.90	23.10	1	30.6	13.40	1	X
P4KE24A	P4KE24CA	20.50	22.80	25.20	1	33.2	12.30	1	X
P4KE27A	P4KE27CA	23.10	25.70	28.40	1	37.5	10.90	1	X
P4KE30A	P4KE30CA	25.60	28.50	31.50	1	41.4	9.90	1	X
P4KE33A	P4KE33CA	28.20	31.40	34.70	1	45.7	9.00	1	X
P4KE36A	P4KE36CA	30.80	34.20	37.80	1	49.9	8.20	1	X
P4KE39A	P4KE39CA	33.30	37.10	41.00	1	53.9	7.60	1	X
P4KE43A	P4KE43CA	36.80	40.90	45.20	1	59.3	6.90	1	X
P4KE47A	P4KE47CA	40.20	44.70	49.40	1	64.8	6.30	1	X
P4KE51A	P4KE51CA	43.60	48.50	53.60	1	70.1	5.80	1	X
P4KE56A	P4KE56CA	47.80	53.20	58.80	1	77.0	5.30	1	X
P4KE62A	P4KE62CA	53.00	58.90	65.10	1	85.0	4.80	1	X
P4KE68A	P4KE68CA	58.10	64.60	71.40	1	92.0	4.50	1	X
P4KE75A	P4KE75CA	64.10	71.30	78.80	1	103.0	4.00	1	X
P4KE82A	P4KE82CA	70.10	77.90	86.10	1	113.0	3.60	1	X
P4KE91A	P4KE91CA	77.80	86.50	95.50	1	125.0	3.30	1	X
P4KE100A	P4KE100CA	85.50	95.00	105.00	1	137.0	3.00	1	X
P4KE110A	-	94.00	105.00	116.00	1	152.0	2.70	1	X
-	P4KE110CA*	94.00	105.00	116.00	1	152.0	4.00	1	X
P4KE120A	-	102.00	114.00	126.00	1	165.0	2.50	1	X
-	P4KE120CA*	102.00	114.00	126.00	1	165.0	3.70	1	X
P4KE130A	-	111.00	124.00	137.00	1	179.0	2.30	1	X
-	P4KE130CA*	111.00	124.00	137.00	1	179.0	3.40	1	X
P4KE150A	-	128.00	143.00	158.00	1	207.0	2.00	1	X
-	P4KE150CA*	128.00	143.00	158.00	1	207.0	2.90	1	X
P4KE160A	-	136.00	152.00	168.00	1	219.0	1.90	1	X
-	P4KE160CA*	136.00	152.00	168.00	1	219.0	2.80	1	X
P4KE170A	-	145.00	162.00	179.00	1	234.0	1.80	1	X
-	P4KE170CA*	145.00	162.00	179.00	1	234.0	2.60	1	X
P4KE180A	-	154.00	171.00	189.00	1	246.0	1.70	1	X
-	P4KE180CA*	154.00	171.00	189.00	1	246.0	2.50	1	X
P4KE200A	-	171.00	190.00	210.00	1	274.0	1.50	1	X
-	P4KE200CA*	171.00	190.00	210.00	1	274.0	2.20	1	X
P4KE220A	-	185.00	209.00	231.00	1	328.0	1.30	1	-
-	P4KE220CA*	185.00	209.00	231.00	1	328.0	1.90	1	-
P4KE250A	-	214.00	237.00	263.00	1	344.0	1.20	1	-
-	P4KE250CA*	214.00	237.00	263.00	1	344.0	1.80	1	-
P4KE300A	-	256.00	285.00	315.00	1	414.0	1.00	1	-
-	P4KE300CA*	256.00	285.00	315.00	1	414.0	1.50	1	-
P4KE350A*	P4KE350CA*	300.00	332.00	368.00	1	482.0	1.30	1	-
P4KE400A*	P4KE400CA*	342.00	380.00	420.00	1	548.0	1.10	1	-
P4KE440A*	P4KE440CA*	376.00	418.00	462.00	1	602.0	1.00	1	-

# Transient Voltage Suppression (TVS) Diodes

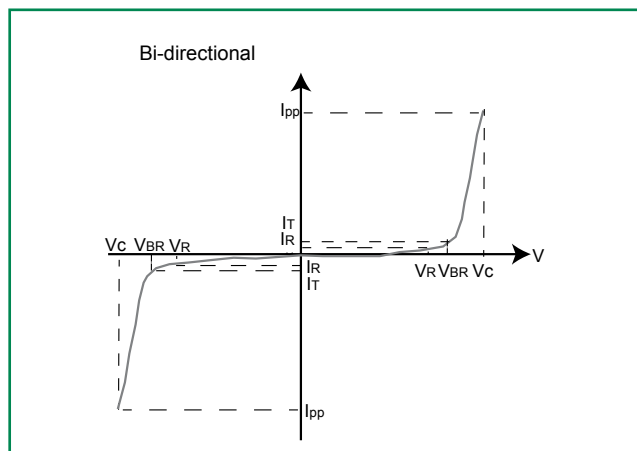
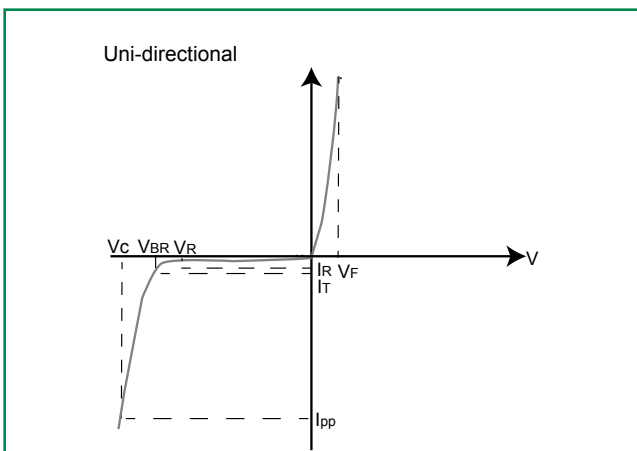
Axial Leaded – 400W > P4KE series

## Electrical Characteristics ( $T_A=25^\circ\text{C}$ unless otherwise noted)

Part Number (Uni)	Part Number (Bi)	Reverse Stand off Voltage $V_R$ (Volts)	Breakdown Voltage $V_{BR} @ I_T$ (V)		Test Current $I_T$ (mA)	Maximum Clamping Voltage $V_C @ I_{pp}$ (V)	Maximum Peak Pulse Current $I_{pp}$ (A)	Maximum Reverse Leakage $I_R @ V_R$ ( $\mu\text{A}$ )	Agency Approval
			MIN	MAX					
P4KE480A*	P4KE480CA*	408.00	456.00	504.00	1	658.0	0.92	1	-
P4KE510A*	P4KE510CA*	434.00	485.00	535.00	1	698.0	0.86	1	-
P4KE530A*	P4KE530CA*	451.00	503.50	556.50	1	725.0	0.83	1	-
P4KE540A*	P4KE540CA*	460.00	513.00	567.00	1	740.0	0.82	1	-
P4KE550A*	P4KE550CA*	468.00	522.50	577.50	1	760.0	0.79	1	-

For bidirectional type having  $V_R$  of 10 volts and less, the  $I_R$  value is double.  
For parts without A, the  $V_{BR}$  is  $\pm 10\%$  and  $V_C$  is 5% higher than with A parts  
For stack-die parts, use \* to label the part number.

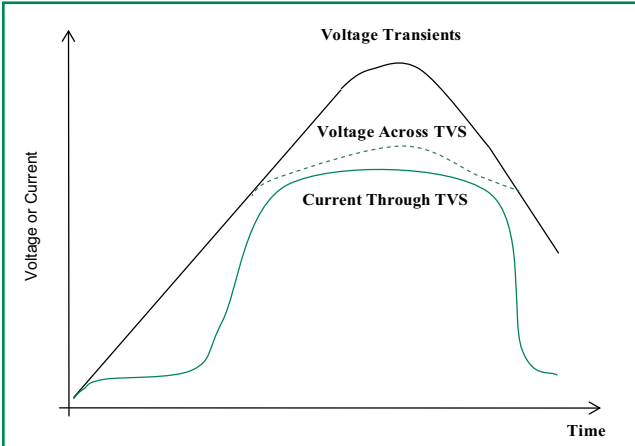
## I-V Curve Characteristics



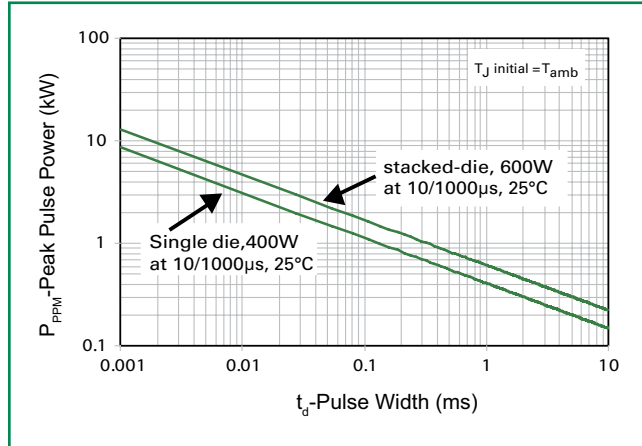
- $P_{PPM}$  Peak Pulse Power Dissipation** – Max power dissipation
- $V_R$  Stand-off Voltage** – Maximum voltage that can be applied to the TVS without operation
- $V_{BR}$  Breakdown Voltage** – Maximum voltage that flows though the TVS at a specified test current ( $I_T$ )
- $V_C$  Clamping Voltage** – Peak voltage measured across the TVS at a specified  $I_{ppm}$  (peak impulse current)
- $I_R$  Reverse Leakage Current** – Current measured at  $V_R$
- $V_F$  Forward Voltage Drop for Uni-directional**

**Ratings and Characteristic Curves** ( $T_A=25^\circ\text{C}$  unless otherwise noted)

**Figure 1 - TVS Transients Clamping Waveform**

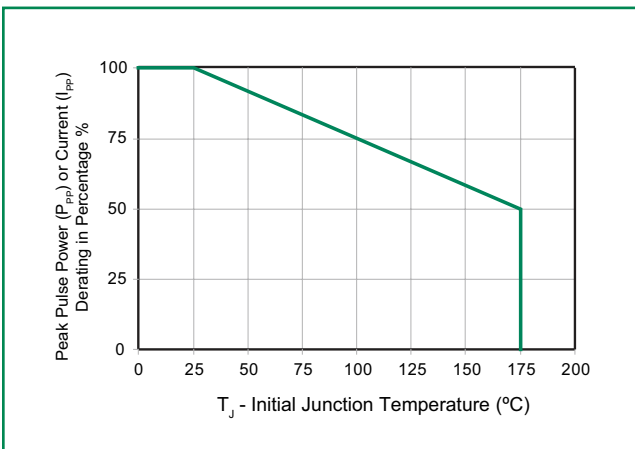


**Figure 2 - Peak Pulse Power Rating Curve**

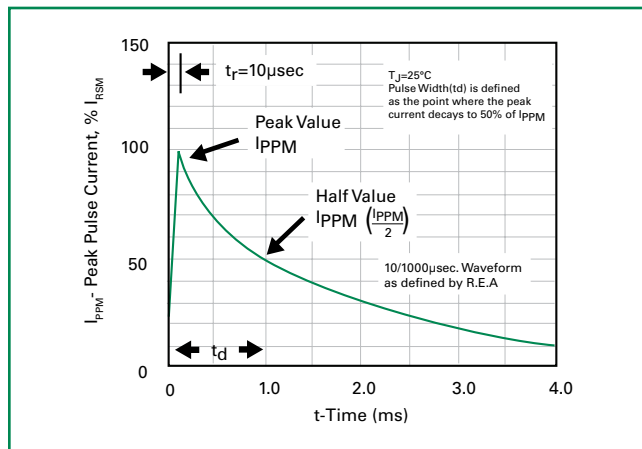


**Ratings and Characteristic Curves** ( $T_A=25^\circ\text{C}$  unless otherwise noted) (Continued)

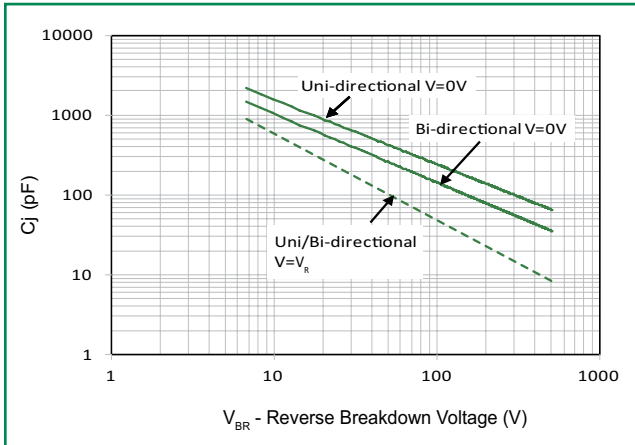
**Figure 3 - Peak Pulse Power Derating Curve**



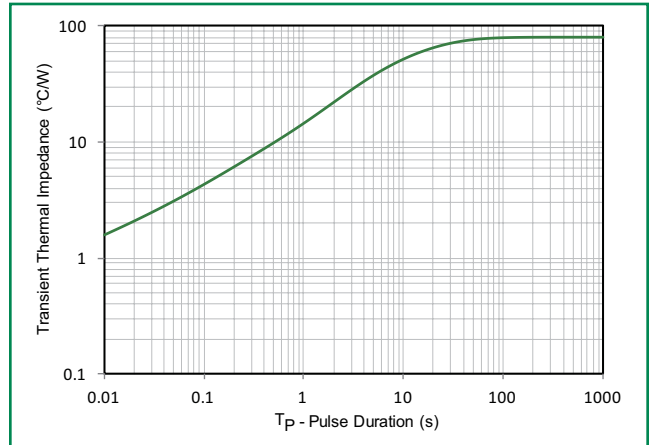
**Figure 4 - Pulse Waveform**



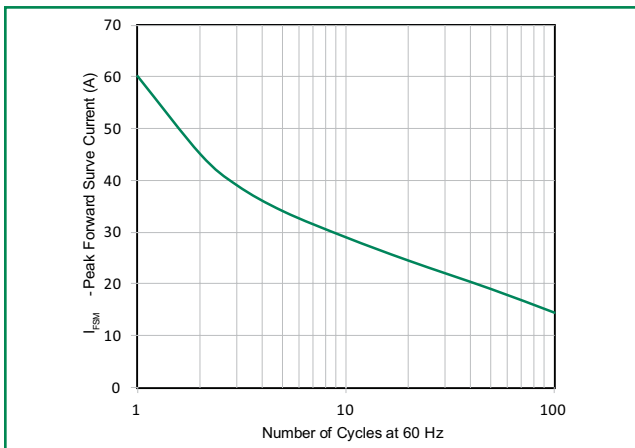
**Figure 5 - Typical Junction Capacitance**



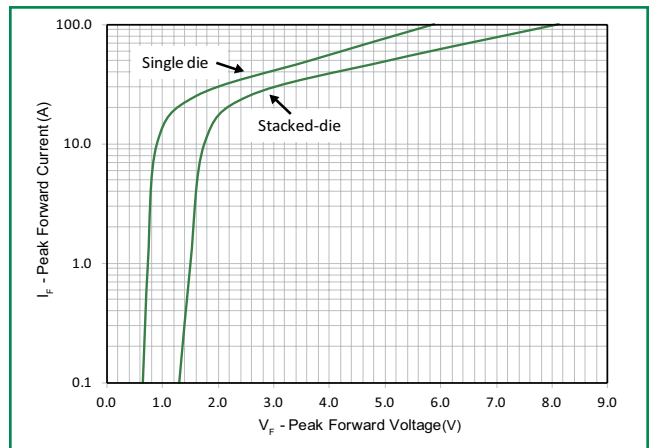
**Figure 6 - Typical Transient Thermal Impedance**



**Figure 7 - Maximum Non-Repetitive Forward Surge Current Uni-Directional Only**

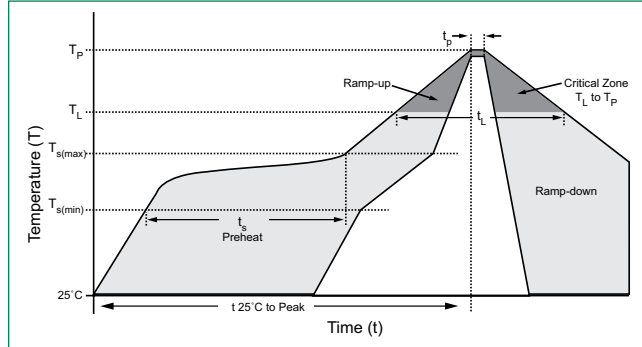


**Figure 8 - Peak Forward Voltage Drop vs Peak Forward Current (Typical Values)**



### Soldering Parameters

Reflow Condition		Lead-free assembly
Pre Heat	- Temperature Min ( $T_{s(min)}$ )	150°C
	- Temperature Max ( $T_{s(max)}$ )	200°C
	- Time (min to max) ( $t_s$ )	60 – 180 secs
Average ramp up rate (Liquidus Temp ( $T_A$ ) to peak)		3°C/second max
$T_{s(max)}$ to $T_A$ - Ramp-up Rate		3°C/second max
Reflow	- Temperature ( $T_A$ ) (Liquidus)	217°C
	- Time (min to max) ( $t_s$ )	60 – 150 seconds
Peak Temperature ( $T_p$ )		260 <sup>+0/-5</sup> °C
Time within 5°C of actual peak Temperature ( $t_p$ )		20 – 40 seconds
Ramp-down Rate		6°C/second max
Time 25°C to peak Temperature ( $T_p$ )		8 minutes Max.
Do not exceed		260°C



### Flow/Wave Soldering (Solder Dipping)

<b>Peak Temperature :</b>	260°C
<b>Dipping Time :</b>	5 seconds
<b>Soldering :</b>	1 time

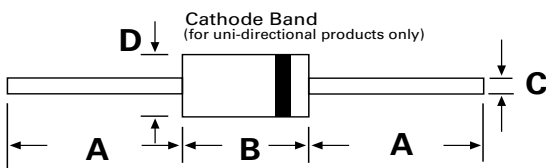
### Physical Specifications

<b>Weight</b>	0.012oz., 0.3g
<b>Case</b>	JEDEC DO-204AL (DO-41) molded plastic body over passivated junction.
<b>Polarity</b>	Colored band indicates unidirectional component's cathode end
<b>Terminal</b>	Matte Tin axial leads, solderable per JESD22-B102.

### Environmental Specifications

<b>High Temp. Storage</b>	JESD22-A103
<b>HTRB</b>	JESD22-A108
<b>Temperature Cycling</b>	JESD22-A104
<b>H3TRB</b>	JESD22-A101
<b>RSH</b>	JESD22-B106

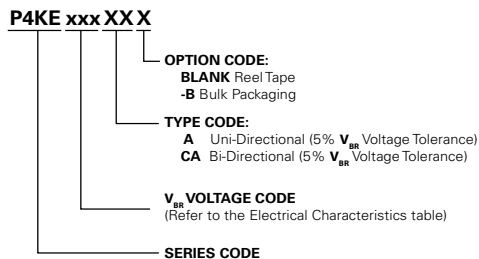
### Dimensions



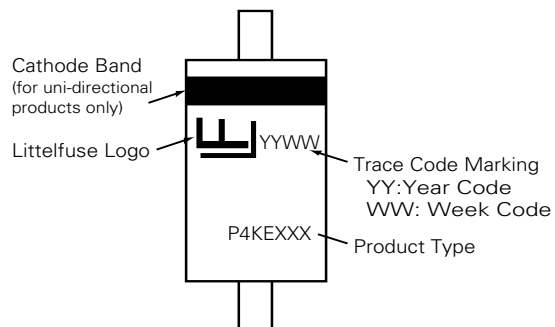
DO-204AL (DO-41)

Dimensions	Inches		Millimeters	
	Min	Max	Min	Max
A	1.000	-	25.40	-
B	0.160	0.205	4.10	5.20
C	0.028	0.034	0.71	0.86
D	0.080	0.107	2.00	2.70

### Part Numbering System



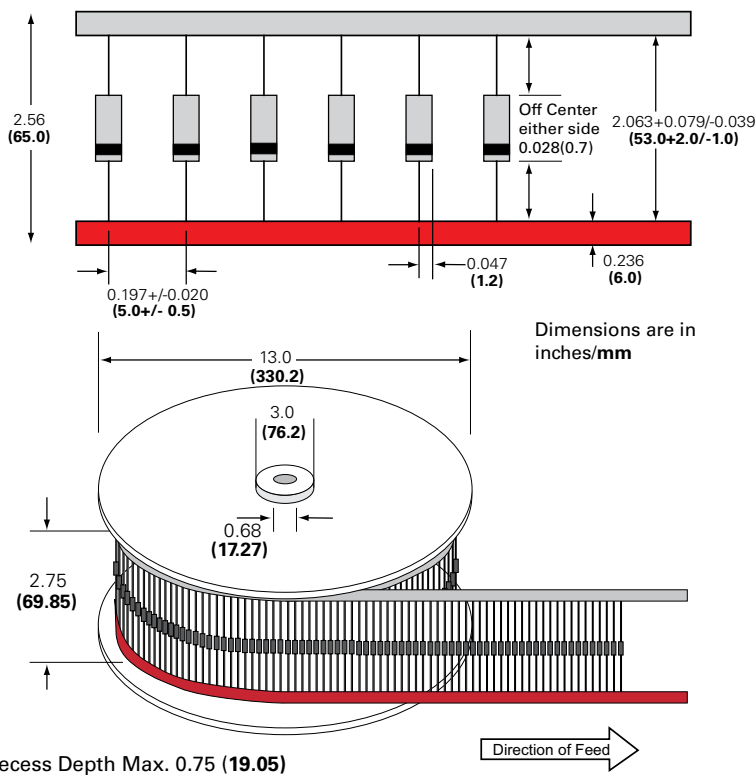
### Part Marking System



### Packaging

Part Number	Component Package	Quantity	Packaging Option	Packaging Specification
P4KExxxXX	DO-204AL	5000	Tape & Reel	EIA STD RS-296
P4KExxxXX-B	DO-204AL	500	BOX	Littelfuse Spec.

### Tape and Reel Specification



**Disclaimer Notice** - Information furnished is believed to be accurate and reliable. However, users should independently evaluate the suitability of and test each product selected for their own applications. Littelfuse products are not designed for, and may not be used in, all applications. Read complete Disclaimer Notice at [www.littelfuse.com/disclaimer-electronics](http://www.littelfuse.com/disclaimer-electronics).

## Looking for pricing, stock, or lifecycle information?

Click below to explore more details on WIN SOURCE:

 [View P4KE75CA on WIN SOURCE](#)

 [Littelfuse Inc. Information](#)

## Optimize Your Supply Chain with WIN SOURCE Solutions

-  Global Sourcing Solution
-  Obsolete Management
-  Cost Control Management
-  Shortage Management
-  Alternative Solution
-  Excess Inventory Management