

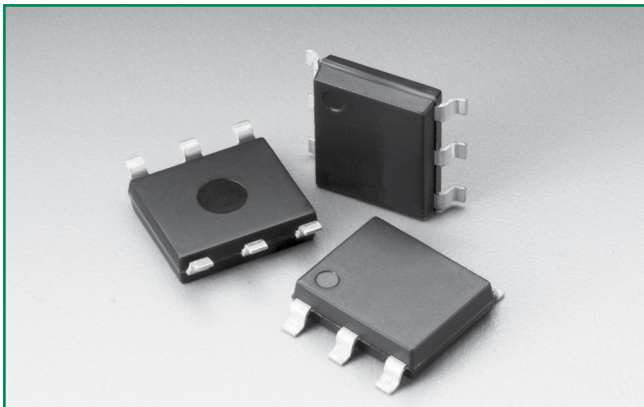

**THE DATASHEET OF
P0304UCLRP**



SIDACtor® Multiport Series - MS-013



Agency Approvals

Agency	Agency File Number
	E133083

Pinout Designation

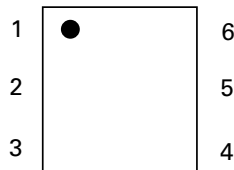

Schematic Symbol

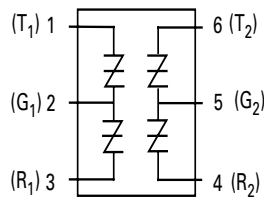

Description

SIDACtor® Multiport Series thyristors MS-013 are designed to protect baseband equipment from overvoltage transients.

Targeted for voice through DS-1 applications, the series provides a dual port surface mount solution that enables equipment to comply with various global regulatory standards.

Features and Benefits

- Low voltage overshoot
- Low on-state voltage
- Does not degrade surge capability after multiple surge events within limit.
- Replaces four discrete components
- Fails short circuit when surged in excess of ratings
- Low capacitance
- RoHS Compliant
- Pb-free E3 means 2nd level interconnect is Pb-free and the terminal finish material is tin(Sn) (IPC/JEDEC J-STD-609A.01)

Applicable Global Standards

- TIA-968-A
- TIA-968-B
- ITU K.20/21 Enhanced Level*
- ITU K.20/21 Basic Level
- GR 1089 Inter-building*
- GR 1089 Intra-building
- IEC 61000-4-5 2nd edition
- YD/T 1082
- YD/T 993
- YD/T 950

*A-rated parts require series resistance

Additional Information



Datasheet



Resources



Samples

Electrical Characteristics

Part Number	Marking	V_{DRM} @ $I_{DRM}=5\mu A$	V_S @ $100V/\mu s$	V_{DRM} @ $I_{DRM}=5\mu A$	V_S @ $100V/\mu s$	V_T @ $I_T=2.2$ Amps	I_H	I_S	I_T	Capacitance
		V min	V max	V min	V max	V max	mA min	mA max	A max	
		Pins 1-2, 3-2, 4-5, 6-5		Pins 1-3, 4-6		Pins 1-2, 3-2, 4-5, 6-5				
P0084UALxx	P0084UA	6	25	12	50	4	50	800	2.2	See Capacitance Values Table
P0304UALxx	P0304UA	25	40	50	80	4	50	800	2.2	
P0644UALxx	P0644UA	58	77	116	154	4	150	800	2.2	
P0724UALxx	P0724UA	65	88	130	176	4	150	800	2.2	
P0904UALxx	P0904UA	75	98	150	196	4	150	800	2.2	
P1104UALxx	P1104UA	90	130	180	260	4	150	800	2.2	
P1304UALxx	P1304UA	120	160	240	320	4	150	800	2.2	
P1504UALxx	P1504UA	140	180	280	360	4	150	800	2.2	

Table continues on next page.

Electrical Characteristics (continued)

Part Number	Marking	V_{DRM} @ $I_{DRM}=5\mu A$	V_S @ 100V/ μs	V_{DRM} @ $I_{DRM}=5\mu A$	V_S @ 100V/ μs	V_T @ $I_T=2.2$ Amps	I_H	I_S	I_T	Capacitance
		V min	V max	V min	V max	V max	mA min	mA max	A max	
		Pins 1-2, 3-2, 4-5, 6-5		Pins 1-3, 4-6		Pins 1-2, 3-2, 4-5, 6-5				
P1804UALxx	P1804UA	170	220	340	440	4	150	800	2.2	See Capacitance Values Table
P2304UALxx	P2304UA	190	260	380	520	4	150	800	2.2	
P2604UALxx	P2604UA	220	300	440	600	4	150	800	2.2	
P3104UALxx	P3104UA	275	350	550	700	4	150	800	2.2	
P3504UALxx	P3504UA	320	400	640	800	4	150	800	2.2	
P0084UCLxx	P0084UC	6	25	12	50	4	50	800	2.2	
P0304UCLxx	P0304UC	25	40	50	80	4	50	800	2.2	
P0644UCLxx	P0644UC	58	77	116	154	4	150	800	2.2	
P0724UCLxx	P0724UC	65	88	130	176	4	150	800	2.2	
P0904UCLxx	P0904UC	75	98	150	196	4	150	800	2.2	
P1104UCLxx	P1104UC	90	130	180	260	4	150	800	2.2	
P1304UCLxx	P1304UC	120	160	240	320	4	150	800	2.2	
P1504UCLxx	P1504UC	140	180	280	360	4	150	800	2.2	
P1804UCLxx	P1804UC	170	220	340	440	4	150	800	2.2	
P2304UCLxx	P2304UC	190	260	380	520	4	150	800	2.2	
P2604UCLxx	P2604UC	220	300	440	600	4	150	800	2.2	
P3104UCLxx	P3104UC	275	350	550	700	4	150	800	2.2	
P3504UCLxx	P3504UC	320	400	640	800	4	150	800	2.2	

Notes:

- Absolute maximum ratings measured at $T_A = +25^\circ C$ (unless otherwise noted).
- Components are bi-directional
- **XX** = Part Number Suffix: **TP** (Tube Pack) or **RP** (Reel Pack).

Capacitance Values

Part Number	Pin 1-2 / 3-2 (4-5 / 6-5) Tip-Ground, Ring-Ground		Pin 1-3 (4-6) Tip-Ring	
	pF min	pF max	pF min	pF max
P0084UALxx	25	155	15	90
P0304UALxx	15	140	10	90
P0644UALxx	40	60	20	35
P0724UALxx	35	60	20	35
P0904UALxx	35	55	20	30
P1104UALxx	30	50	15	30
P1304UALxx	25	45	15	25
P1504UALxx	25	40	15	25
P1804UALxx	25	35	10	20
P2304UALxx	25	35	10	20
P2604UALxx	20	35	10	20
P3104UALxx	20	35	10	20
P3504UALxx	20	35	10	20
P0084UCLxx	35	285	20	165
P0304UCLxx	25	250	10	145
P0644UCLxx	55	155	30	90
P0724UCLxx	50	145	25	85
P0904UCLxx	45	135	25	80
P1104UCLxx	45	115	25	65
P1304UCLxx	40	105	20	60
P1504UCLxx	35	95	20	55
P1804UCLxx	35	90	15	50
P2604UCLxx	30	85	15	50
P3104UCLxx	30	80	15	45
P3504UCLxx	25	75	15	45

Surge Ratings

Series	I_{PP}									I_{TSM}	di/dt
	0.2/310 ¹	2/10 ¹	8/20 ¹	10/160 ¹	10/560 ¹	5/320 ¹	10/360 ¹	10/1000 ¹	5/310 ¹		
	0.5/700 ²	2/10 ²	1.2/50 ²	10/160 ²	10/560 ²	9/720 ²	10/360 ²	10/1000 ²	10/700 ²		
	A min	A min	A min	A min	A min	A min	A min	A min	A min	A min	A/μs max
A	20	150	150	90	50	75	75	45	75	20	500
C	50	500	400	200	150	200	175	100	200	30	500

Notes:
 1 Current waveform in μs - Peak pulse current rating (I_{pp}) is repetitive and guaranteed for the life of the product that remains in thermal equilibrium.
 2 Voltage waveform in μs - I_{pp} ratings applicable over temperature range of -40°C to +85°C
 - The component must initially be in thermal equilibrium with -40°C ≤ T_J ≤ +150°C

Thermal Considerations

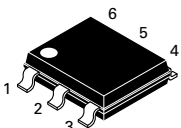
Package	Symbol	Parameter	Value	Unit
 Modified MS-013	T_J	Operating Junction Temperature Range	-40 to +150	°C
	T_S	Storage Temperature Range	-65 to +150	°C
	$R_{\theta JA}$	Thermal Resistance: Junction to Ambient	60	°C/W

V-I Characteristics

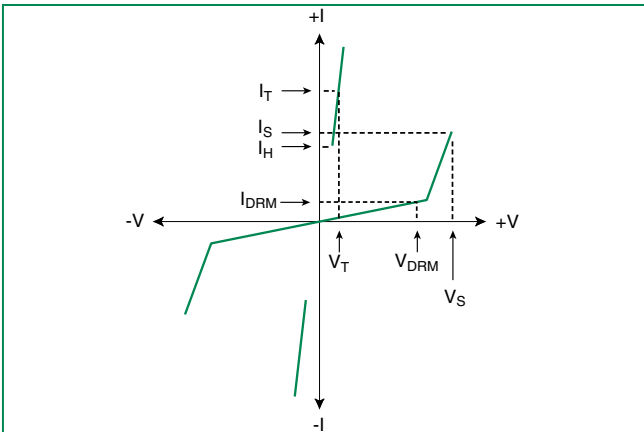

$t_r \times t_d$ Pulse Waveform

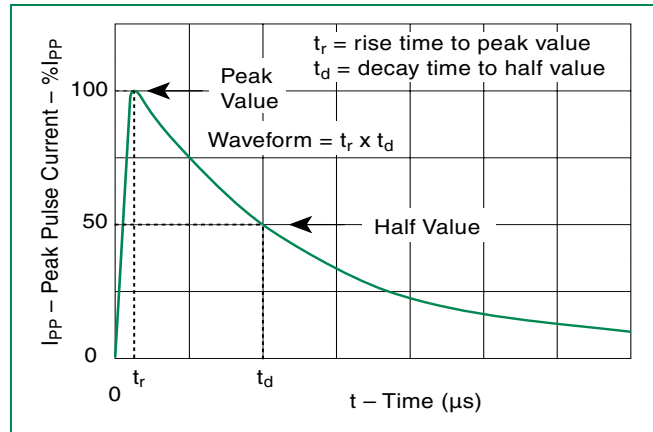

Normalized V_S Change vs. Junction Temperature

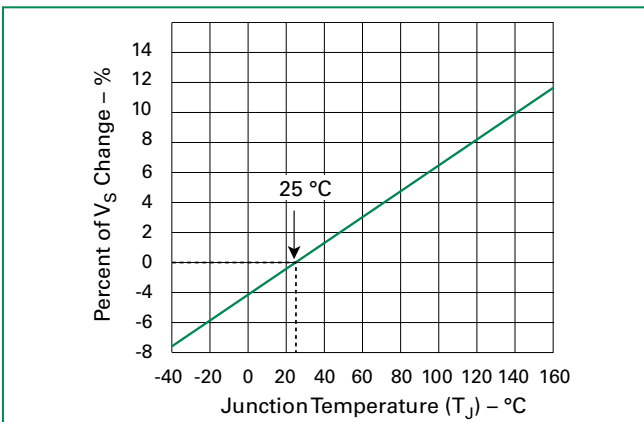

Normalized DC Holding Current vs. Case Temperature

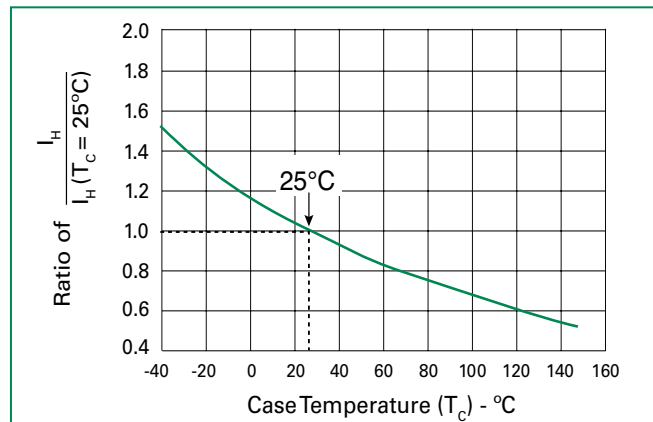

Soldering Parameters

Reflow Condition	Pb-Free assembly (see Fig. 1)	
Pre Heat	-Temperature Min ($T_{s(min)}$)	+150°C
	-Temperature Max ($T_{s(max)}$)	+200°C
	-Time (Min to Max) (t_s)	60-180 secs.
Average ramp up rate (Liquidus Temp (T_L) to peak)	3°C/sec. Max.	
$T_{s(max)}$ to T_L - Ramp-up Rate	3°C/sec. Max.	
Reflow	-Temperature (T_L) (Liquidus)	+217°C
	-Temperature (t_L)	60-150 secs.
Peak Temp (T_p)	+260(+0/-5)°C	
Time within 5°C of actual PeakTemp (t_p)	30 secs. Max.	
Ramp-down Rate	6°C/sec. Max.	
Time 25°C to Peak Temp (T_p)	8 min. Max.	
Do not exceed	+260°C	

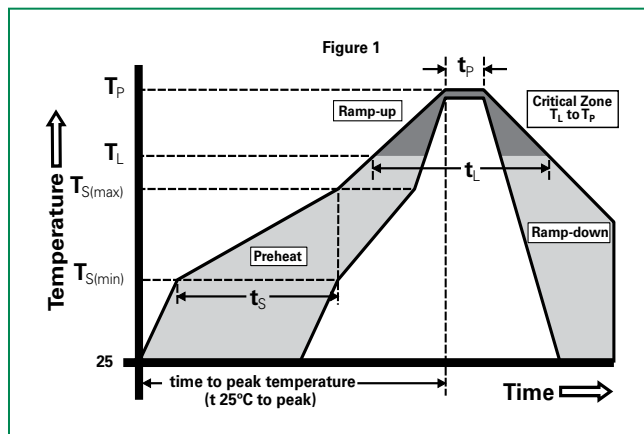

Physical Specifications

Lead Material	Copper Alloy
Terminal Finish	100% Matte-Tin Plated
Body Material	UL Recognized epoxy meeting flammability classification V-0

Environmental Specifications

High Temp Voltage Blocking	80% Rated V_{DRM} ($V_{AC Peak}$) +125°C or +150°C, 504 or 1008 hrs. MIL-STD-750 (Method 1040) JEDEC, JESD22-A-101
Temp Cycling	-65°C to +150°C, 15 min. dwell, 10 up to 100 cycles. MIL-STD-750 (Method 1051) EIA/JEDEC, JESD22-A-104
Biased Temp & Humidity	52 V_{DC} (+85°C) 85%RH, 504 up to 1008 hrs. EIA/JEDEC, JESD22-A-101
High Temp Storage	+150°C 1008 hrs. MIL-STD-750 (Method 1031) JEDEC, JESD22-A-101
Low Temp Storage	-65°C, 1008 hrs.
Thermal Shock	0°C to +100°C, 5 min. dwell, 10 sec. transfer, 10 cycles. MIL-STD-750 (Method 1056) JEDEC, JESD22-A-106
Autoclave (Pressure Cooker Test)	+121°C, 100%RH, 2atm, 24 up to 168 hrs. EIA/JEDEC, JESD22-A-102
Resistance to Solder Heat	+260°C, 30 secs. MIL-STD-750 (Method 2031)
Moisture Sensitivity Level	85%RH, +85°C, 168 hrs., 3 reflow cycles (+260°C Peak). JEDEC-J-STD-020, Level 1

Part Numbering

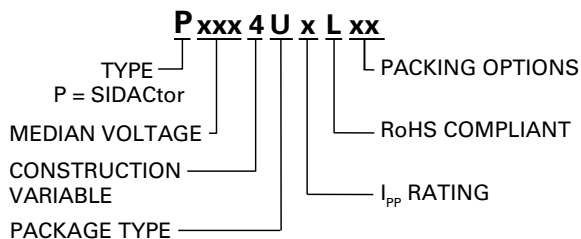

Part Marking

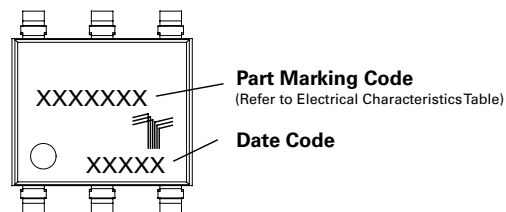

Dimensions – MS-013

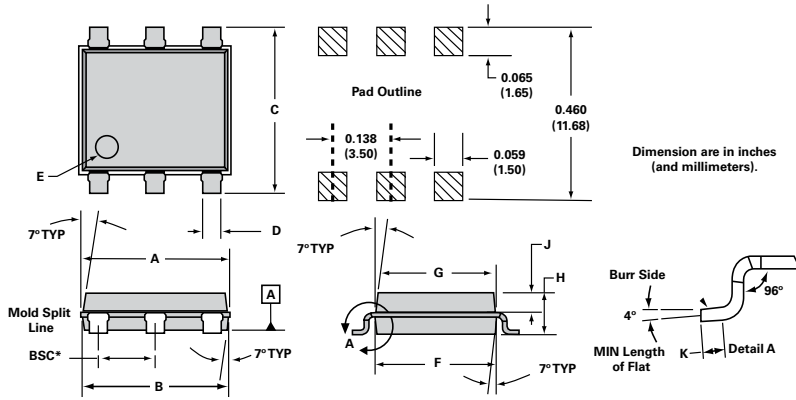

Dimensions	Inches		Millimeters	
	Min	Max	Min	Max
A	0.360	0.364	9.14	9.25
B	0.352	0.356	8.94	9.04
C	0.400	0.412	10.16	10.46
D	0.043	0.045	1.09	1.13
E	0.047	0.055	1.19	1.40
F	0.293	0.297	7.44	7.54
G	0.289	0.293	7.34	7.44
H	0.089	0.093	2.26	2.36
J	0.041	0.049	1.04	1.24
K	0.020	—	0.51	—
BSC*	0.133	0.143	3.38	3.63

* BSC = Basic Spacing between Centers

Packing Options

Package Type	Description	Quantity	Added Suffix	Industry Standard
U	Modified MS-013 6-pin Tape and Reel Pack	1500	RP	EIA-481-D
	Modified MS-013 6-pin Tube Pack	500 (50 per tube)	TP	N/A

Tape and Reel Specification – MS-013

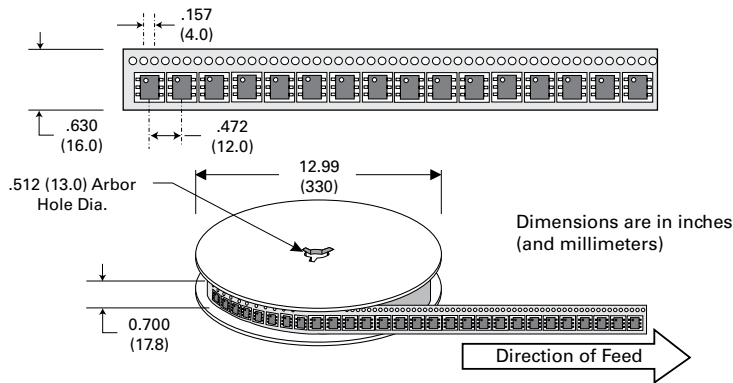

Tube Pack Specification – MS-013

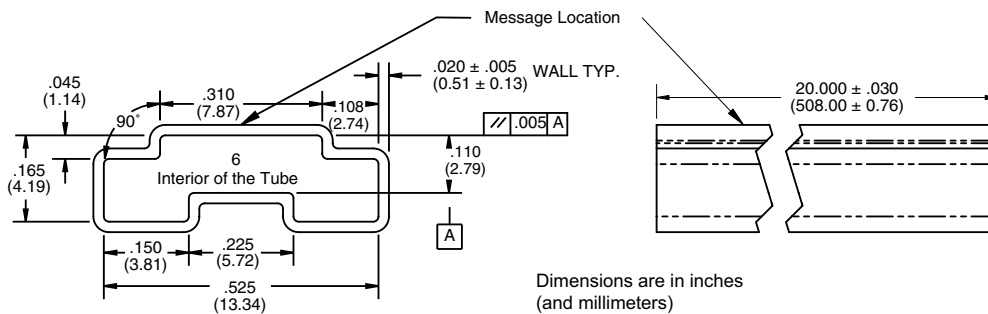

Disclaimer Notice - Information furnished is believed to be accurate and reliable. However, users should independently evaluate the suitability of and test each product selected for their own applications. Littelfuse products are not designed for, and may not be used in, all applications. Read complete Disclaimer Notice at www.littelfuse.com/disclaimer-electronics.

Looking for pricing, stock, or lifecycle information?

Click below to explore more details on WIN SOURCE:

 [View P0304UCLRP on WIN SOURCE](#)

 [Littelfuse Inc. Information](#)

Optimize Your Supply Chain with WIN SOURCE Solutions

-  Global Sourcing Solution
-  Obsolete Management
-  Cost Control Management
-  Shortage Management
-  Alternative Solution
-  Excess Inventory Management