



**THE DATASHEET OF
OPA4243EA/250**





OPA4243



For most current data sheet and other product information, visit www.burr-brown.com

Quad OPERATIONAL AMPLIFIER *MicroPOWER, Single-Supply*

FEATURES

- MICRO-SIZE, TSSOP PACKAGE
- SINGLE-SUPPLY OPERATION
- WIDE SUPPLY RANGE: 2.2V to 36V
- LOW QUIESCENT CURRENT: 45 μ A/chan
- WIDE BANDWIDTH: 430kHz
- WIDE INPUT/OUTPUT SWING

APPLICATIONS

- LCD DISPLAY DRIVERS
- BATTERY POWERED SYSTEMS
- PORTABLE EQUIPMENT
- PCMCIA CARDS
- BATTERY PACKS AND POWER SUPPLIES
- CONSUMER PRODUCTS

DESCRIPTION

The OPA4243 is a four-channel op amp specifically designed for high density, space-limited applications, such as LCD bias drivers, PCMCIA cards, battery-packs and portable instruments. In addition to small size, this part features wide output swing, very low quiescent current, and low bias current. Other features include unity gain stability and the best speed power ratio available. Power supplies in the range of 2.2V to 36V ($\pm 1.1V$ to $\pm 18V$) can be used.

Each channel uses completely independent circuitry for lowest crosstalk and freedom from interaction, even when overloaded. In addition, the amplifier is free from output inversion when the inputs are driven to the rail. The OPA4243EA is supplied in the miniature TSSOP-14 surface mount package. Specifications apply from $-40^{\circ}C$ to $+85^{\circ}C$. However, as the extensive typical performance curves indicate, the OPA4243 can be used over the full $-55^{\circ}C$ to $+125^{\circ}C$ range. A SPICE macromodel is available for design analysis.

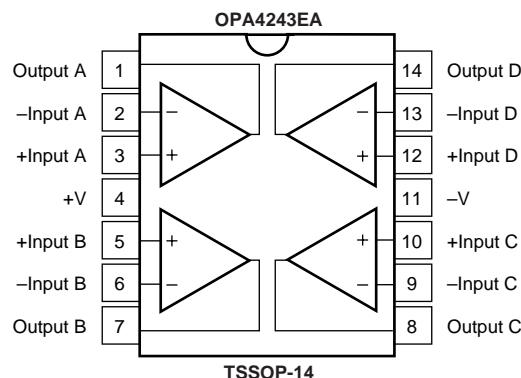

International Airport Industrial Park • Mailing Address: PO Box 11400, Tucson, AZ 85734 • Street Address: 6730 S. Tucson Blvd., Tucson, AZ 85706 • Tel: (520) 746-1111
Twx: 910-952-1111 • Internet: <http://www.burr-brown.com/> • Cable: BBRCORP • Telex: 066-6491 • FAX: (520) 889-1510 • Immediate Product Info: (800) 548-6132

SPECIFICATIONS: $V_S = +2.6V$ to $+36V$

Boldface limits apply over the specified temperature range, $T_A = -40^{\circ}C$ to $+85^{\circ}C$

At $T_A = +25^{\circ}C$, $R_L = 20k\Omega$ connected to ground, unless otherwise noted.

PARAMETER	CONDITIONS	OPA4243EA			UNITS
		MIN	TYP ⁽¹⁾	MAX	
OFFSET VOLTAGE					
Input Offset Voltage Over Temperature	$V_{OS} = \pm 7.5V, V_{CM} = 0$		± 2	± 5	mV
vs Temperature	$T_A = -40^{\circ}C$ to $+85^{\circ}C$		± 2.5	± 6	mV
vs Power Supply	$V_S = +2.6V$ to $+36V$		2.5	100	$\mu V/^{\circ}C$
Over Temperature	$V_S = +2.6V$ to $+36V$			100	$\mu V/V$
Channel Separation			140		dB
INPUT BIAS CURRENT					
Input Bias Current	$V_{CM} = V_S/2$		-10	-25	nA
Input Offset Current	$V_{CM} = V_S/2$		± 1	± 10	nA
NOISE					
Input Noise Voltage, $f = 0.1$ to $10Hz$			0.4		$\mu Vp-p$
Input Noise Voltage Density, $f = 1kHz$			22		nV/\sqrt{Hz}
Current Noise Density, $f = 1kHz$			40		fA/\sqrt{Hz}
INPUT VOLTAGE RANGE					
Common-Mode Voltage Range		0		$(V+) - 0.9$	V
Common-Mode Rejection	$V_S = \pm 18V, V_{CM} = -18V$ to $+17.1V$	82	104		dB
Over Temperature	$V_S = \pm 18V, V_{CM} = -18V$ to $+17.1V$	82			dB
INPUT IMPEDANCE					
Differential			$10^6 \parallel 2$		$\Omega \parallel pF$
Common-Mode			$10^9 \parallel 2$		$\Omega \parallel pF$
OPEN-LOOP GAIN					
Open-Loop Voltage Gain	$V_O = 0.5V$ to $(V+) - 0.9$	86	104		dB
Over Temperature	$V_O = 0.5V$ to $(V+) - 0.9$	86			dB
FREQUENCY RESPONSE					
Gain-Bandwidth Product			430		kHz
Slew Rate	$G = 1$		$-0.1, \pm 0.16$		$V/\mu s$
Setting Time, 0.01%	10V Step		150		μs
Overload Recovery Time	$V_{IN} \bullet Gain = V_S$		8		μs
OUTPUT					
Voltage Output, Positive	$A_{OL} \geq 80dB, R_L = 20k\Omega$ to $V_S/2$	$(V+) - 0.9$	$(V+) - 0.75$		V
Over Temperature	$A_{OL} \geq 80dB, R_L = 20k\Omega$ to $V_S/2$	$(V+) - 0.9$	$(V+) - 0.75$		V
Voltage Output, Negative	$A_{OL} \geq 80dB, R_L = 20k\Omega$ to $V_S/2$	0.5	0.2		V
Over Temperature	$A_{OL} \geq 80dB, R_L = 20k\Omega$ to $V_S/2$	0.5	0.2		V
Voltage Output, Positive	$A_{OL} \geq 80dB, R_L = 20k\Omega$ to Ground		$(V+) - 0.75$		V
Over Temperature	$A_{OL} \geq 80dB, R_L = 20k\Omega$ to Ground		$(V+) - 0.75$		V
Voltage Output, Negative	$A_{OL} \geq 80dB, R_L = 20k\Omega$ to Ground		0.1		V
Over Temperature	$A_{OL} \geq 80dB, R_L = 20k\Omega$ to Ground		0.1		V
Short-Circuit Current	$A_{OL} \geq 80dB, R_L = 20k\Omega$ to Ground		$-25, +12$		mA
Capacitive Load Drive			See Typical Curve		
POWER SUPPLY					
Specified Voltage Range	Over Temperature	+2.6		+36	V
Minimum Operating Voltage			+2.2		V
Quiescent Current	$I_O = 0$		45	60	μA
Over Temperature	$I_O = 0$			70	μA
TEMPERATURE RANGE					
Specified Range		-40		85	$^{\circ}C$
Operating Range		-55		125	$^{\circ}C$
Storage Range		-65		150	$^{\circ}C$
Thermal Resistance	θ_{JA}				
TSSOP-14 Surface Mount			100		$^{\circ}C/W$

NOTE: (1) $V_S = +15V$.

ABSOLUTE MAXIMUM RATINGS⁽¹⁾

Supply Voltage, V+ to V-	36V
Input Voltage Range ⁽²⁾	(V-) - 0.3V to (V+) + 0.3V
Input Current ⁽²⁾	10mA
Output Short-Circuit ⁽³⁾	Continuous
Operating Temperature	-55°C to +125°C
Storage Temperature	-65°C to +150°C
Junction Temperature	150°C
Lead Temperature (soldering, 10s)	300°C
ESD Capability	2000V

NOTES: (1) Stresses above these ratings may cause permanent damage. Exposure to absolute maximum conditions for extended periods may degrade device reliability. (2) Inputs are diode-clamped to the supply rails and should be current-limited to 10mA or less if input voltages can exceed rails by more than 0.3V. (3) Short-circuit to ground, one amplifier per package.



ELECTROSTATIC DISCHARGE SENSITIVITY

This integrated circuit can be damaged by ESD. Burr-Brown recommends that all integrated circuits be handled with appropriate precautions. Failure to observe proper handling and installation procedures can cause damage.

ESD damage can range from subtle performance degradation to complete device failure. Precision integrated circuits may be more susceptible to damage because very small parametric changes could cause the device not to meet its published specifications.

PACKAGE/ORDERING INFORMATION

PRODUCT	PACKAGE	PACKAGE DRAWING NUMBER	SPECIFIED TEMPERATURE RANGE	PACKAGE MARKING	ORDERING NUMBER ⁽¹⁾	TRANSPORT MEDIA
OPA4243EA "	TSSOP-14 "	357 "	-40°C to +85°C "	OPA4243EA "	OPA4243EA/250 OPA4243EA/2K5	Tape and Reel Tape and Reel

NOTE: (1) Models with a slash (/) are available only in Tape and Reel in the quantities indicated (e.g., /2K5 indicates 2500 devices per reel). Ordering 2500 pieces of "OPA4243EA" will get a single 2500-piece Tape and Reel.

TYPICAL PERFORMANCE CURVES

At $T_A = +25^\circ\text{C}$, $R_L = 20\text{k}\Omega$ connected to ground, unless otherwise noted.

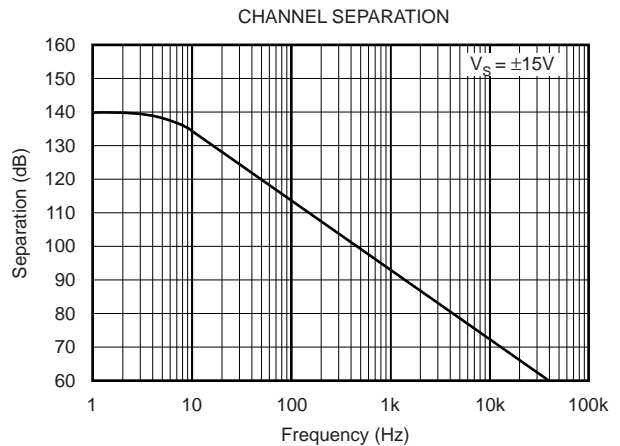
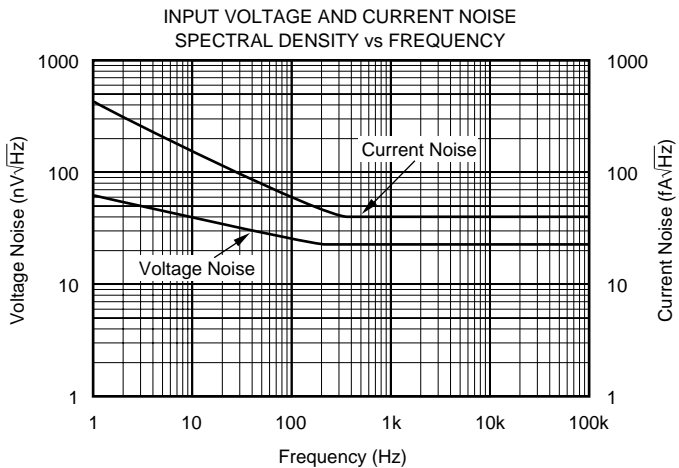
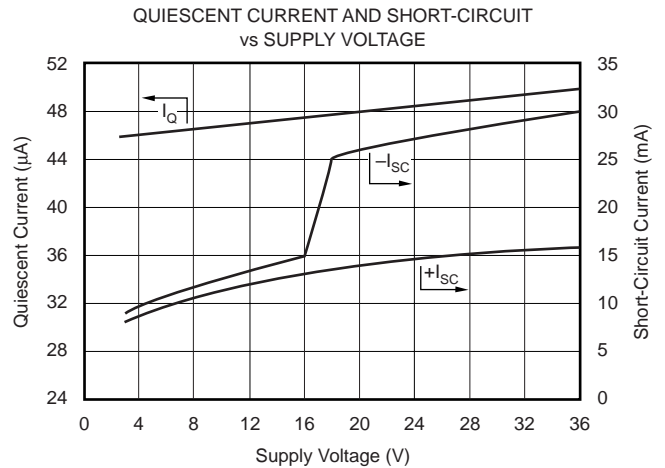
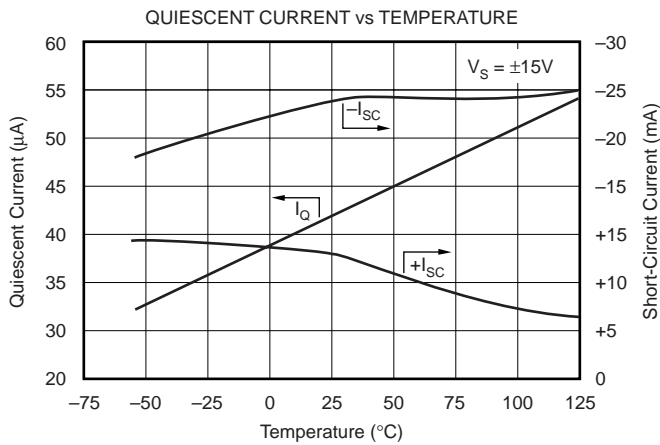
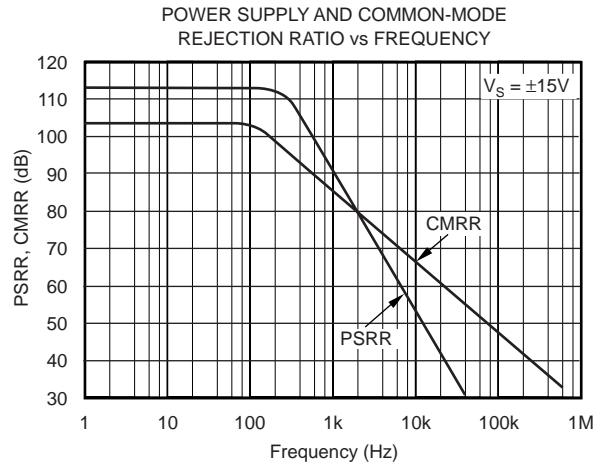
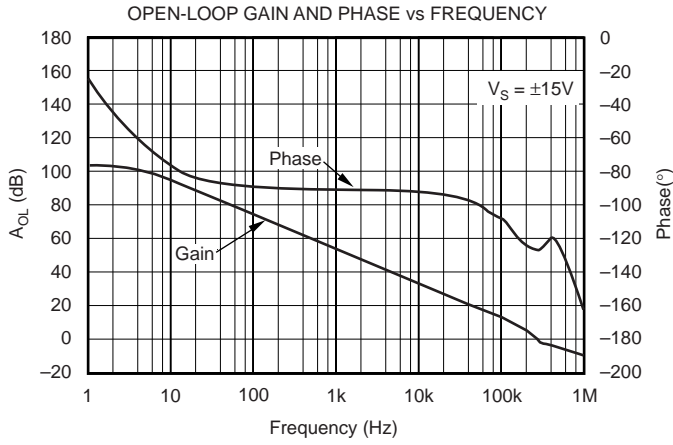

TYPICAL PERFORMANCE CURVES (Cont.)

At $T_A = +25^\circ\text{C}$, $R_L = 20\text{k}\Omega$ connected to ground, unless otherwise noted.

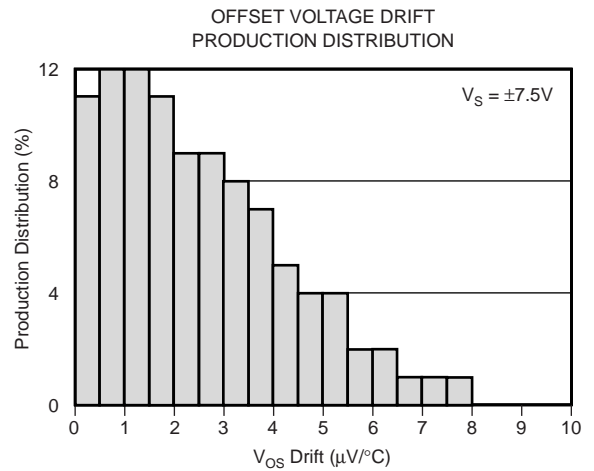
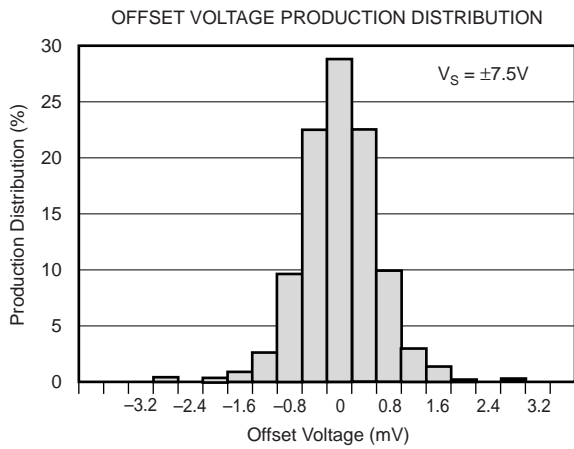
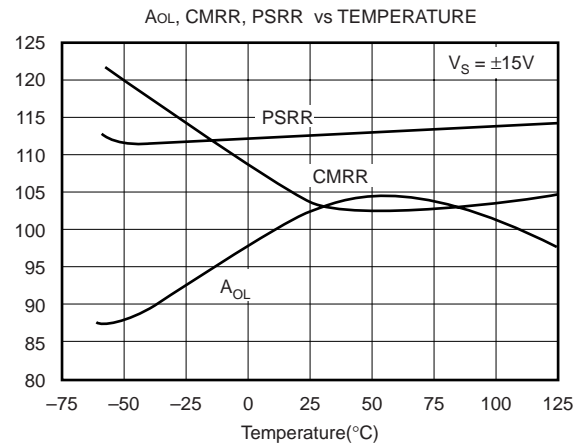
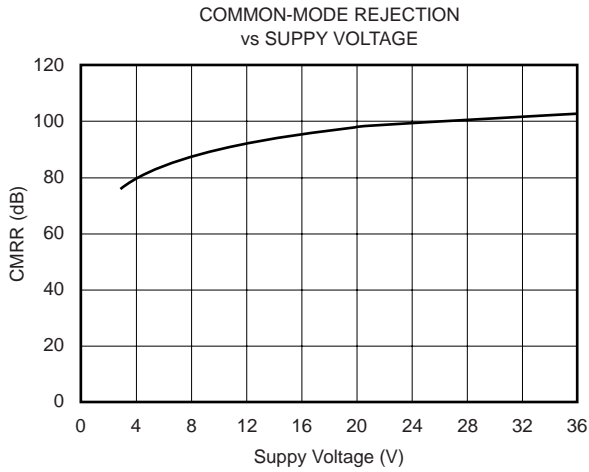
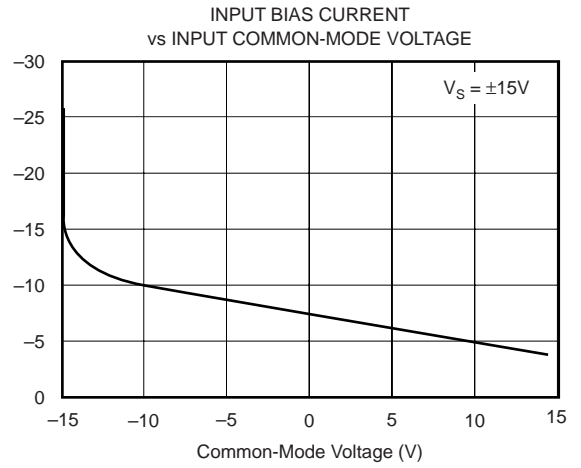
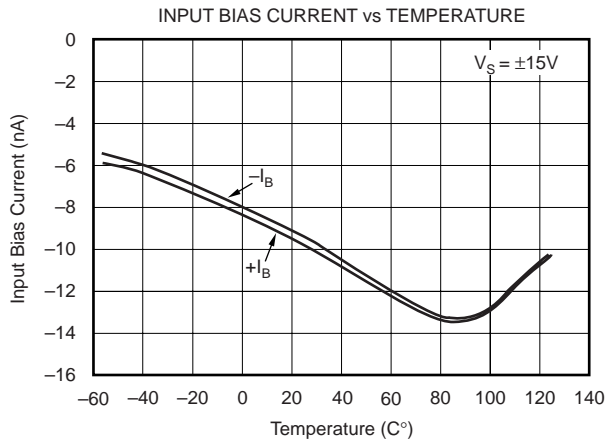

TYPICAL PERFORMANCE CURVES (Cont.)

At $T_A = +25^\circ\text{C}$, $R_L = 20\text{k}\Omega$ connected to ground, unless otherwise noted.

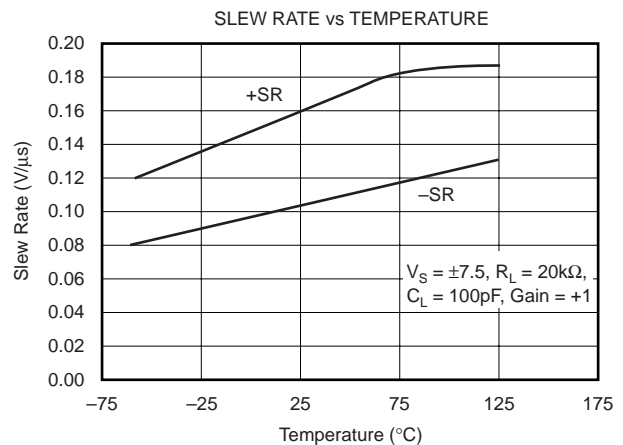
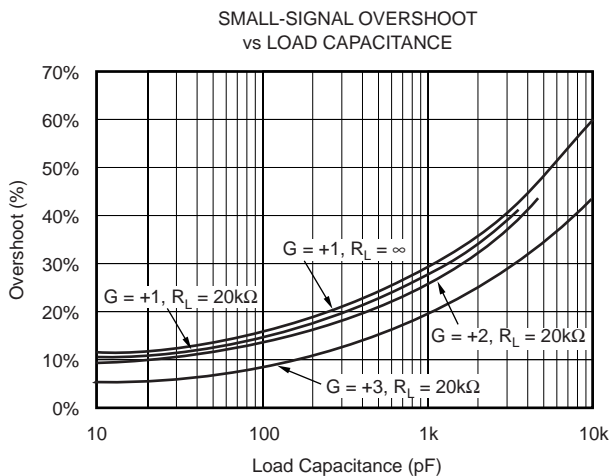
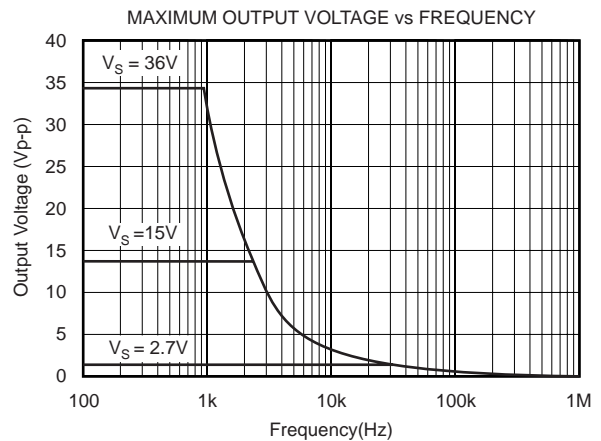
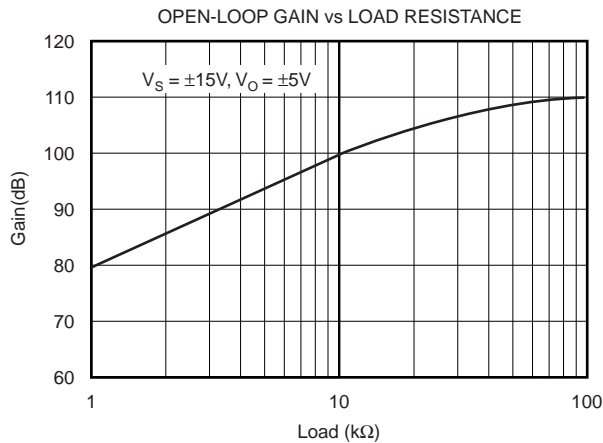
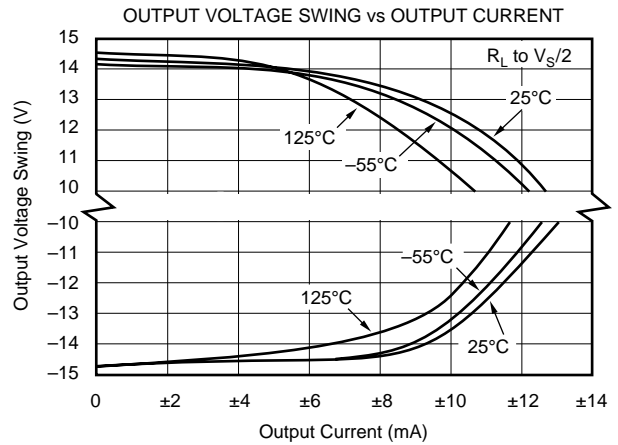
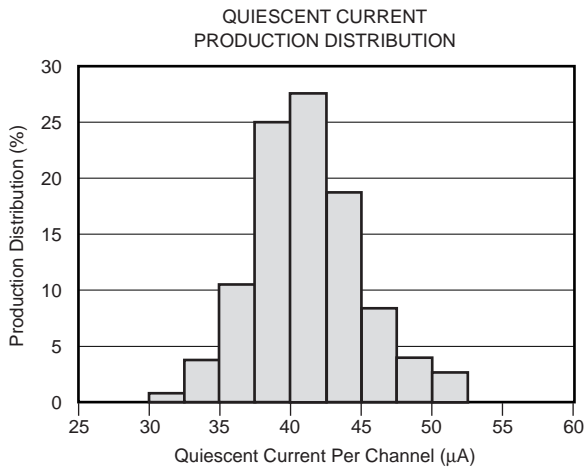

TYPICAL PERFORMANCE CURVES (Cont.)

At $T_A = +25^\circ\text{C}$, $R_L = 20\text{k}\Omega$ connected to ground, unless otherwise noted.

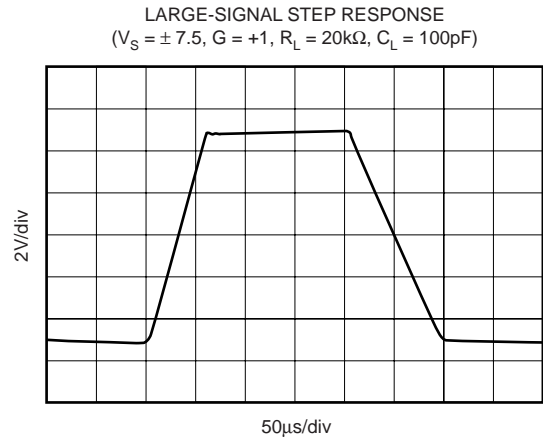
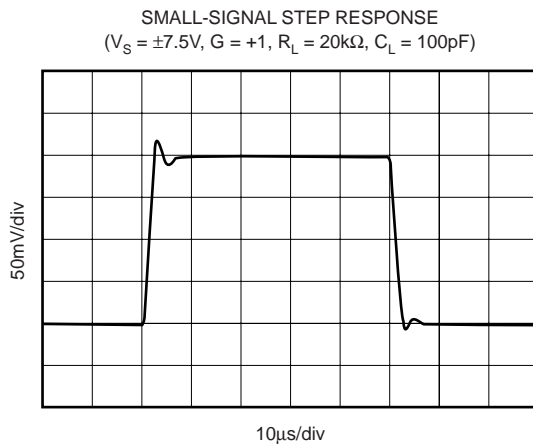

APPLICATION INFORMATION

The OPA4243 is unity-gain stable and suitable for a wide range of general-purpose applications. The power supply pins should be bypassed with $0.01\mu\text{F}$ ceramic capacitors.

OPERATING VOLTAGE

The OPA4243 can operate from single supply (2.2V to 36V) or dual supplies ($\pm 1.1\text{V}$ to $\pm 18\text{V}$) with excellent performance. Unlike most op amps which are specified at only one supply voltage, the OPA4243 is specified for real world applications; a single set of specifications applies throughout the 2.6V to 36V supply range. This allows the designer to have the same assured performance at any supply voltage within this range.

In addition, many key parameters are guaranteed over the specified temperature range, -40°C to $+85^\circ\text{C}$. Most behaviors remain unchanged throughout the full operating voltage range. Parameters, which vary significantly with operating voltage or temperature, are shown in the typical performance curves.

PRINTED CIRCUIT BOARD LAYOUT

See Burr-Brown Application Note AB-132 for specific PC board layout recommendations.

INPUT PROTECTION

Rail-to-rail input signals will not cause damage or invert the output of the OPA4243. To protect against ESD and excessive input voltage (beyond the supply rails) the OPA4243 includes diodes from the input terminals to the power supply rails. Normally, these diodes are reversed biased and have negligible effect on circuit operation. However, if the input voltage is allowed to exceed the supply voltages by enough to forward bias these diodes (generally, 0.3V to 0.6V) excessive input current could flow. If this condition could occur (for example, if an input signal is applied when the op amp supply voltage is zero), care should be taken to limit the input current to less than 10mA to avoid damage. An input signal beyond the supplies, with power applied, can cause an unexpected output inversion.

PACKAGING INFORMATION

Orderable Device	Status (1)	Package Type	Package Drawing	Pins	Package Qty	Eco Plan (2)	Lead/Ball Finish (6)	MSL Peak Temp (3)	Op Temp (°C)	Device Marking (4/5)	Samples
OPA4243EA/250	ACTIVE	TSSOP	PW	14	250	Green (RoHS & no Sb/Br)	CU NIPDAU	Level-3-260C-168 HR	-40 to 85	OPA 4243EA	Samples
OPA4243EA/2K5	ACTIVE	TSSOP	PW	14	2500	Green (RoHS & no Sb/Br)	CU NIPDAU	Level-3-260C-168 HR	-40 to 85	OPA 4243EA	Samples

(1) The marketing status values are defined as follows:

ACTIVE: Product device recommended for new designs.

LIFEBUY: TI has announced that the device will be discontinued, and a lifetime-buy period is in effect.

NRND: Not recommended for new designs. Device is in production to support existing customers, but TI does not recommend using this part in a new design.

PREVIEW: Device has been announced but is not in production. Samples may or may not be available.

OBSOLETE: TI has discontinued the production of the device.

(2) Eco Plan - The planned eco-friendly classification: Pb-Free (RoHS), Pb-Free (RoHS Exempt), or Green (RoHS & no Sb/Br) - please check <http://www.ti.com/productcontent> for the latest availability information and additional product content details.

TBD: The Pb-Free/Green conversion plan has not been defined.

Pb-Free (RoHS): TI's terms "Lead-Free" or "Pb-Free" mean semiconductor products that are compatible with the current RoHS requirements for all 6 substances, including the requirement that lead not exceed 0.1% by weight in homogeneous materials. Where designed to be soldered at high temperatures, TI Pb-Free products are suitable for use in specified lead-free processes.

Pb-Free (RoHS Exempt): This component has a RoHS exemption for either 1) lead-based flip-chip solder bumps used between the die and package, or 2) lead-based die adhesive used between the die and leadframe. The component is otherwise considered Pb-Free (RoHS compatible) as defined above.

Green (RoHS & no Sb/Br): TI defines "Green" to mean Pb-Free (RoHS compatible), and free of Bromine (Br) and Antimony (Sb) based flame retardants (Br or Sb do not exceed 0.1% by weight in homogeneous material)

(3) MSL, Peak Temp. - The Moisture Sensitivity Level rating according to the JEDEC industry standard classifications, and peak solder temperature.

(4) There may be additional marking, which relates to the logo, the lot trace code information, or the environmental category on the device.

(5) Multiple Device Markings will be inside parentheses. Only one Device Marking contained in parentheses and separated by a "~" will appear on a device. If a line is indented then it is a continuation of the previous line and the two combined represent the entire Device Marking for that device.

(6) Lead/Ball Finish - Orderable Devices may have multiple material finish options. Finish options are separated by a vertical ruled line. Lead/Ball Finish values may wrap to two lines if the finish value exceeds the maximum column width.

Important Information and Disclaimer: The information provided on this page represents TI's knowledge and belief as of the date that it is provided. TI bases its knowledge and belief on information provided by third parties, and makes no representation or warranty as to the accuracy of such information. Efforts are underway to better integrate information from third parties. TI has taken and continues to take reasonable steps to provide representative and accurate information but may not have conducted destructive testing or chemical analysis on incoming materials and chemicals. TI and TI suppliers consider certain information to be proprietary, and thus CAS numbers and other limited information may not be available for release.

In no event shall TI's liability arising out of such information exceed the total purchase price of the TI part(s) at issue in this document sold by TI to Customer on an annual basis.

TAPE AND REEL INFORMATION



QUADRANT ASSIGNMENTS FOR PIN 1 ORIENTATION IN TAPE



*All dimensions are nominal

Device	Package Type	Package Drawing	Pins	SPQ	Reel Diameter (mm)	Reel Width W1 (mm)	A0 (mm)	B0 (mm)	K0 (mm)	P1 (mm)	W (mm)	Pin1 Quadrant
OPA4243EA/250	TSSOP	PW	14	250	180.0	12.4	6.9	5.6	1.6	8.0	12.0	Q1
OPA4243EA/2K5	TSSOP	PW	14	2500	330.0	12.4	6.9	5.6	1.6	8.0	12.0	Q1

TAPE AND REEL BOX DIMENSIONS

*All dimensions are nominal

Device	Package Type	Package Drawing	Pins	SPQ	Length (mm)	Width (mm)	Height (mm)
OPA4243EA/250	TSSOP	PW	14	250	210.0	185.0	35.0
OPA4243EA/2K5	TSSOP	PW	14	2500	367.0	367.0	35.0

IMPORTANT NOTICE

Texas Instruments Incorporated and its subsidiaries (TI) reserve the right to make corrections, enhancements, improvements and other changes to its semiconductor products and services per JESD46, latest issue, and to discontinue any product or service per JESD48, latest issue. Buyers should obtain the latest relevant information before placing orders and should verify that such information is current and complete. All semiconductor products (also referred to herein as "components") are sold subject to TI's terms and conditions of sale supplied at the time of order acknowledgment.

TI warrants performance of its components to the specifications applicable at the time of sale, in accordance with the warranty in TI's terms and conditions of sale of semiconductor products. Testing and other quality control techniques are used to the extent TI deems necessary to support this warranty. Except where mandated by applicable law, testing of all parameters of each component is not necessarily performed.

TI assumes no liability for applications assistance or the design of Buyers' products. Buyers are responsible for their products and applications using TI components. To minimize the risks associated with Buyers' products and applications, Buyers should provide adequate design and operating safeguards.

TI does not warrant or represent that any license, either express or implied, is granted under any patent right, copyright, mask work right, or other intellectual property right relating to any combination, machine, or process in which TI components or services are used. Information published by TI regarding third-party products or services does not constitute a license to use such products or services or a warranty or endorsement thereof. Use of such information may require a license from a third party under the patents or other intellectual property of the third party, or a license from TI under the patents or other intellectual property of TI.

Reproduction of significant portions of TI information in TI data books or data sheets is permissible only if reproduction is without alteration and is accompanied by all associated warranties, conditions, limitations, and notices. TI is not responsible or liable for such altered documentation. Information of third parties may be subject to additional restrictions.

Resale of TI components or services with statements different from or beyond the parameters stated by TI for that component or service voids all express and any implied warranties for the associated TI component or service and is an unfair and deceptive business practice. TI is not responsible or liable for any such statements.

Buyer acknowledges and agrees that it is solely responsible for compliance with all legal, regulatory and safety-related requirements concerning its products, and any use of TI components in its applications, notwithstanding any applications-related information or support that may be provided by TI. Buyer represents and agrees that it has all the necessary expertise to create and implement safeguards which anticipate dangerous consequences of failures, monitor failures and their consequences, lessen the likelihood of failures that might cause harm and take appropriate remedial actions. Buyer will fully indemnify TI and its representatives against any damages arising out of the use of any TI components in safety-critical applications.

In some cases, TI components may be promoted specifically to facilitate safety-related applications. With such components, TI's goal is to help enable customers to design and create their own end-product solutions that meet applicable functional safety standards and requirements. Nonetheless, such components are subject to these terms.

No TI components are authorized for use in FDA Class III (or similar life-critical medical equipment) unless authorized officers of the parties have executed a special agreement specifically governing such use.

Only those TI components which TI has specifically designated as military grade or "enhanced plastic" are designed and intended for use in military/aerospace applications or environments. Buyer acknowledges and agrees that any military or aerospace use of TI components which have **not** been so designated is solely at the Buyer's risk, and that Buyer is solely responsible for compliance with all legal and regulatory requirements in connection with such use.

TI has specifically designated certain components as meeting ISO/TS16949 requirements, mainly for automotive use. In any case of use of non-designated products, TI will not be responsible for any failure to meet ISO/TS16949.

Products

Audio	www.ti.com/audio
Amplifiers	amplifier.ti.com
Data Converters	dataconverter.ti.com
DLP® Products	www.dlp.com
DSP	dsp.ti.com
Clocks and Timers	www.ti.com/clocks
Interface	interface.ti.com
Logic	logic.ti.com
Power Mgmt	power.ti.com
Microcontrollers	microcontroller.ti.com
RFID	www.ti-rfid.com
OMAP Applications Processors	www.ti.com/omap
Wireless Connectivity	www.ti.com/wirelessconnectivity

Applications

Automotive and Transportation	www.ti.com/automotive
Communications and Telecom	www.ti.com/communications
Computers and Peripherals	www.ti.com/computers
Consumer Electronics	www.ti.com/consumer-apps
Energy and Lighting	www.ti.com/energy
Industrial	www.ti.com/industrial
Medical	www.ti.com/medical
Security	www.ti.com/security
Space, Avionics and Defense	www.ti.com/space-avionics-defense
Video and Imaging	www.ti.com/video

TI E2E Community

e2e.ti.com

Looking for pricing, stock, or lifecycle information?

Click below to explore more details on WIN SOURCE:

 [View OPA4243EA/250](#) on WIN SOURCE

 [Texas Instruments](#) Information

Optimize Your Supply Chain with WIN SOURCE Solutions

-  Global Sourcing Solution
-  Obsolete Management
-  Cost Control Management
-  Shortage Management
-  Alternative Solution
-  Excess Inventory Management