



THE DATASHEET OF NLB-310-T1



NLB-310

Cascadable Broadband GaAs MMIC Amplifier
DC to 10GHz

The NLB-310 cascadable broadband InGaP/GaAs MMIC amplifier is a low-cost, high-performance solution for general purpose RF and microwave amplification needs. This 50Ω gain block is based on a reliable HBT proprietary MMIC design, providing unsurpassed performance for small-signal applications. Designed with an external bias resistor, the NLB-310 provides flexibility and stability. The NLB-310 is packaged in a low cost, surface-mount plastic package, providing ease of assembly for high-volume tape-and-reel requirements.

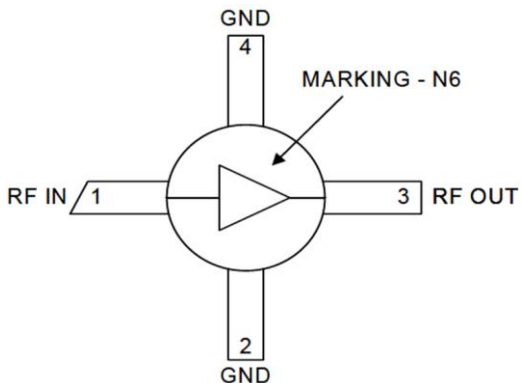

Functional Block Diagram



Package: Micro-X, 4-pin, Plastic

Features

- Reliable, Low-Cost HBT Design
- 12.7dB Gain, +12.6dBm P1dB at 2Ghz
- High P1dB of +14.9dBm at 6.0GHz +13.1dBm at 10.0GHz
- Single Power Supply Operation
- 50Ω I/O Matched for High Frequency Use

Applications

- Narrow and Broadband Commercial and Military Radio Designs
- Linear and Saturated Amplifiers
- Gain Stage or Driver Amplifiers for MWRadio/Optical Designs (PTP/PMP/LMDS/UNII/VSAT/WLAN/Cellular/DWDM)

Ordering Information

NLB-310	Cascadable Broadband GaAs MMIC Amplifier DC to 10GHz
NLB-310-T1	Tape & Reel, 1000 Pieces
NLB-310-E	Fully Assembled Evaluation Board
NBB-X-K1	Extended Frequency InGaP Amp Designer's Tool Kit

Absolute Maximum Ratings

Parameter	Rating	Unit
RF Input Power	+20	dBm
Power Dissipation	300	mW
Device Current	70	mA
Channel Temperature	200	°C
Operating Temperature	-45 to +85	°C
Storage Temperature	-65 to +150	°C

Exceeding any one or a combination of these limits may cause permanent damage.



Caution! ESD sensitive device.



RoHS (Restriction of Hazardous Substances): Compliant per EU Directive 2011/65/EU.

Exceeding any one or a combination of the Absolute Maximum Rating conditions may cause permanent damage to the device. Extended application of Absolute Maximum Rating conditions to the device may reduce device reliability. Specified typical performance or functional operation of the device under Absolute Maximum Rating conditions is not implied.

Nominal Operating Parameters

Parameter	Specification			Unit	Condition
	Min	Typ	Max		
General Performance					
$V_D = +4.6V$, $I_{CC} = 50mA$, $Z_0 = 50\Omega$, $T_A = +25^\circ C$					
Small Signal Power Gain, S21	12.0	12.7		dB	f = 0.1GHz to 1.0GHz
		10.7		dB	f = 1.0GHz to 4.0GHz
		10.0		dB	f = 4.0GHz to 6.0GHz
	8.5	9.7		dB	f = 6.0GHz to 10.0GHz
		9.6		dB	f = 10.0GHz to 12.0GHz
Gain Flatness, GF		± 0.3		dB	f = 5.0GHz to 10.0GHz
Input VSWR		1.6:1			f = 0.1GHz to 4.0GHz
		1.75:1			f = 4.0GHz to 7.0GHz
		1.6:1			f = 7.0GHz to 11.0GHz
Output VSWR		1.5:1			f = 0.1GHz to 4.0GHz
		1.8:1			f = 4.0GHz to 7.0GHz
		1.6:1			f = 7.0GHz to 11.0GHz
Output Power at -1dB Compression, P1dB		12.6		dBm	f = 2.0GHz
		14.9		dBm	f = 6.0GHz
		13.1		dBm	f = 10.0GHz
Noise Figure, NF		5.0		dB	f = 3.0GHz
Third Order Intercept, IP3		+28.9		dBm	f = 2.0GHz
		+27.9			f = 6.0GHz
Reverse Isolation, S12		-17		dB	f = 0.1GHz to 20.0GHz
Device Voltage, V_o	4.4	4.6	4.8	V	
Gain Temperature Coefficient, $\delta G_T / \delta T$		-0.0015		dB/°C	

Parameter	Specification			Unit	Condition
	Min	Typ	Max		
MTTF versus Temperature at $I_{CC} = 50\text{mA}$					
Case Temperature		85		°C	
Junction Temperature		125		°C	
MTTF		>1,000,000		hours	
Thermal Resistance					
θ_{JC}		174		°C/W	$\frac{J_T - T_{CASE}}{V_D \cdot I_{CC}} = \theta_{JC} (\text{°C/Watt})$

Pin Names and Descriptions

Pin	Name	Description	Interface Schematic
1	RFIN	RF input pin. This pin is NOT internally DC blocked. A DC blocking capacitor, suitable for the frequency of operation, should be used in most applications. DC coupling of the input is not allowed, because this will override the internal feedback loop and cause temperature instability.	
2	GND	Ground connection. For best performance, keep traces physically short and connect immediately to ground plane.	
3	RFOUT	RF output and bias pin. Biasing is accomplished with an external series resistor and choke inductor to VCC. The resistor is selected to set the DC current into this pin to a desired level. The resistor value is determined by the following equation: $R = \frac{(V_{CC} - V_{DEVICE})}{I_{CC}}$ Care should also be taken in the resistor selection to ensure that the current into the part never exceeds maximum datasheet operating current over the planned operating temperature. This means that a resistor between the supply and this pin is always required, even if a supply near 5.0V is available, to provide DC feedback to prevent thermal runaway. Because DC is present on this pin, a DC blocking capacitor, suitable for the frequency of operation, should be used in most applications. The supply side of the bias network should also be well bypassed.	
4	GND	Same as pin 2.	

Package Drawing

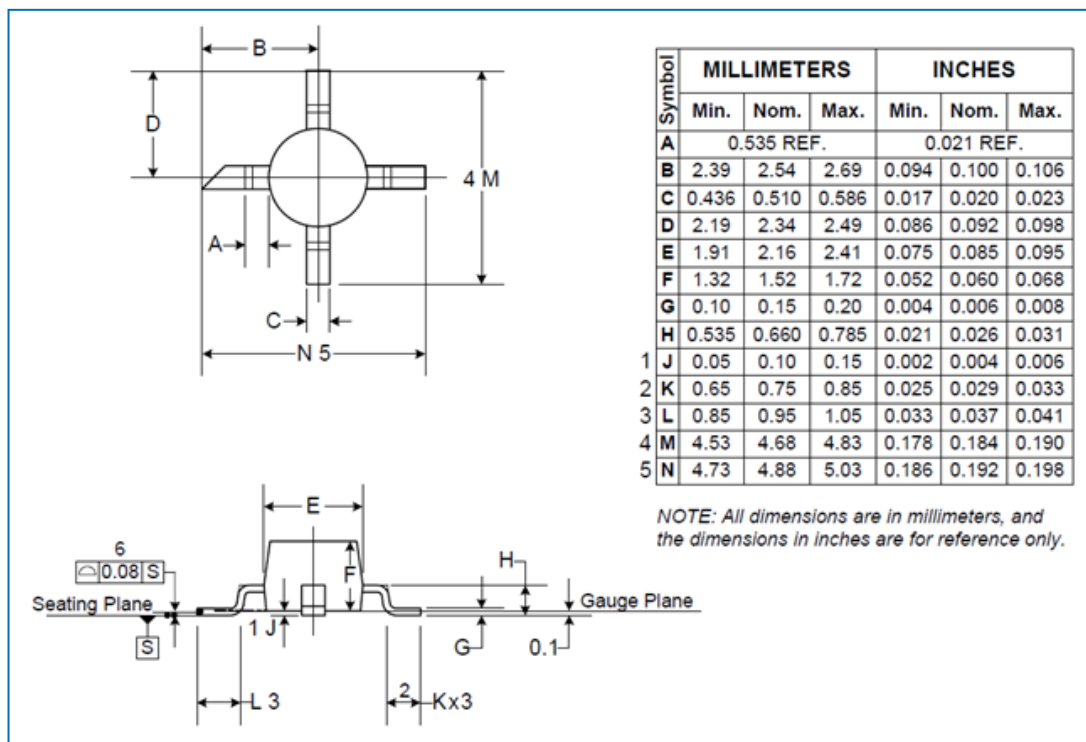

Typical Bias Configuration

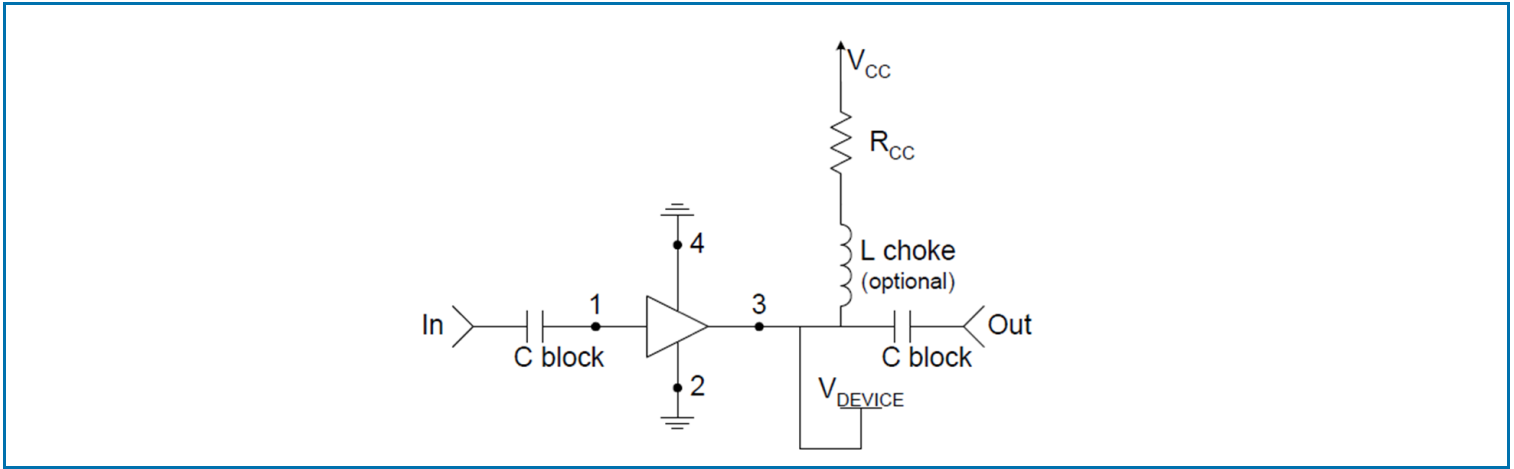

NOTE: Application notes related to biasing circuit, device footprint, and thermal considerations are available on request.

Recommended Bias Resistor Values					
Supply Voltage, V_{CC} (V)	8	10	12	15	20
Bias Resistor, R_{CC} (Ω)	60	100	140	200	300

Extended Frequency InGaP Amplifier Designer's Tool Kit (NBB-X-K1)

This tool kit was created to assist in the design-in of the RFMD NBB- and NLB- series InGaP HBT gain block amplifiers. Each tool kit contains the following:

- 5 each NBB-300, NBB-310 and NBB-400 Ceramic Micro-X Amplifiers
- 5 each NLB-300, NLB-310 and NLB-400 Plastic Micro-X Amplifiers
- 2 Broadband Evaluation Boards and High Frequency SMA Connectors
- Broadband Bias Instructions and Specification Summary Index for ease of operation

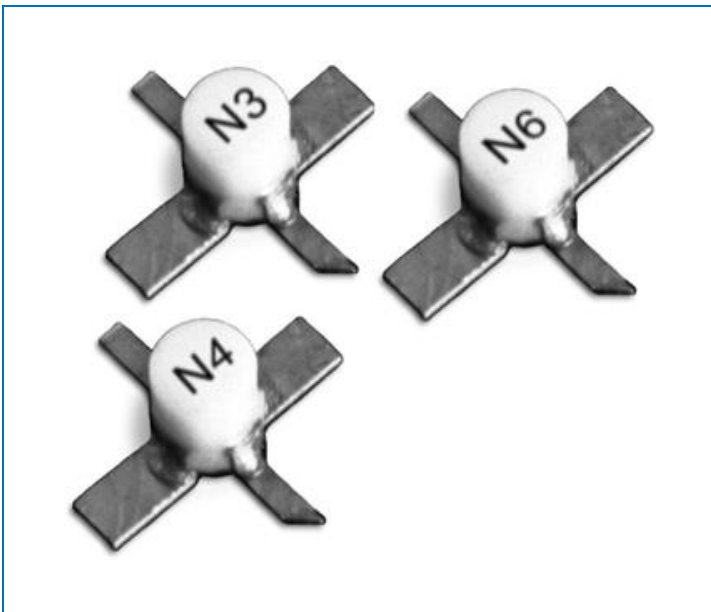

Tape and Reel Dimensions (all dimensions in millimeters)

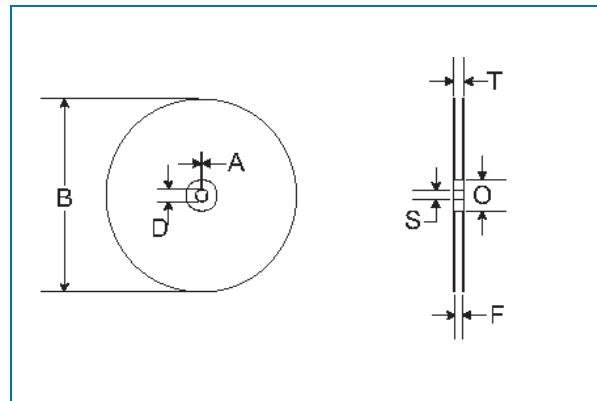

14.732 mm (7") REEL			Plastic, Micro-X	
	ITEMS	SYMBOL	SIZE (mm)	SIZE (inches)
FLANGE	Diameter	B	178 +0.25/-4.0	7.0 +0.079/-0.158
	Thickness	T	18.4 MAX	0.724 MAX
	Space Between Flange	F	12.8 +2.0	0.50 +0.08
HUB	Outer Diameter	O	76.2 REF	3.0 REF
	Spindle Hole Diameter	S	13.716 +0.5/-0.2	0.540 +0.020/-0.008
	Key Slit Width	A	1.5 MIN	0.059 MIN
	Key Slit Diameter	D	20.2 MIN	0.795 MIN

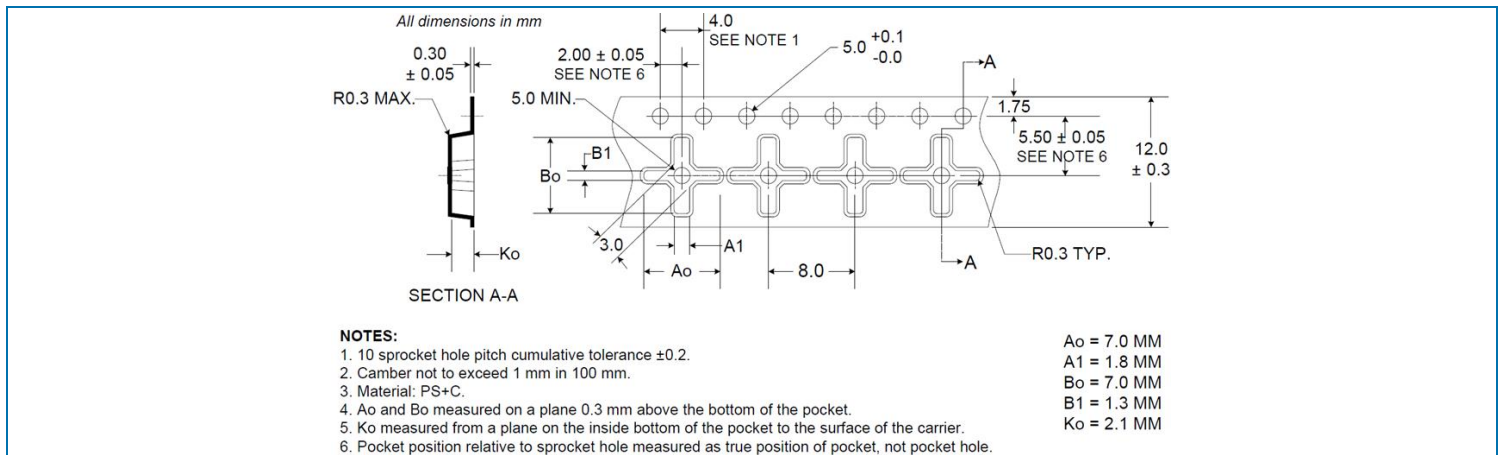
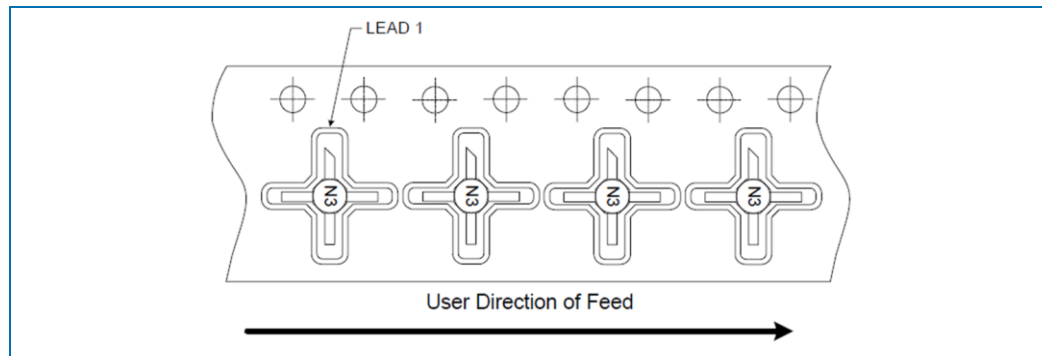

Typical Performance

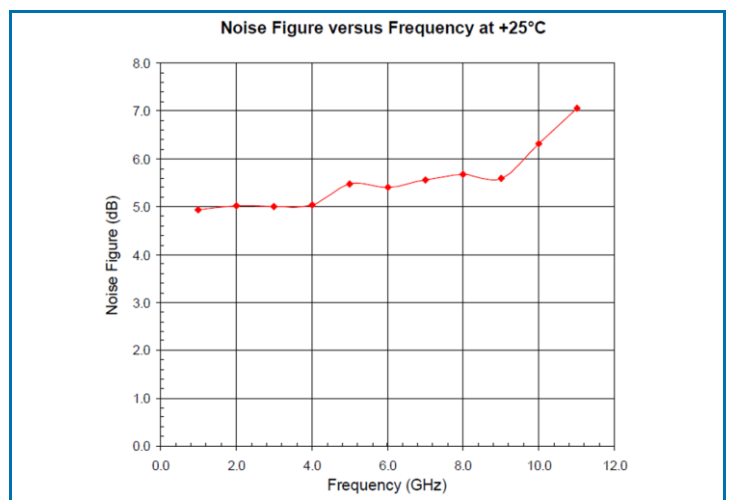
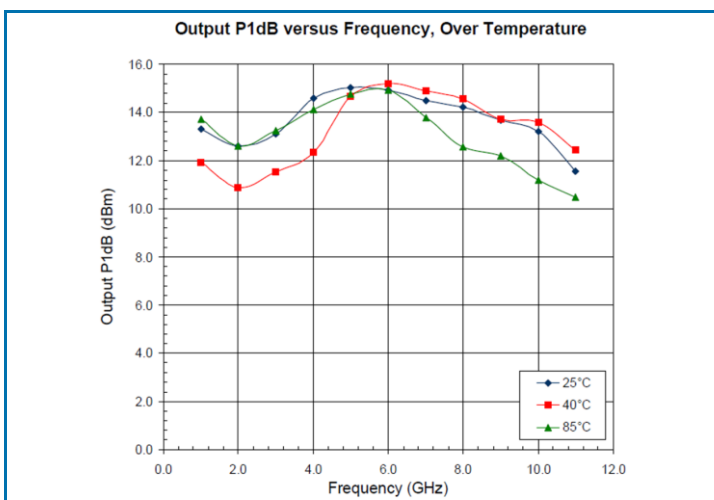
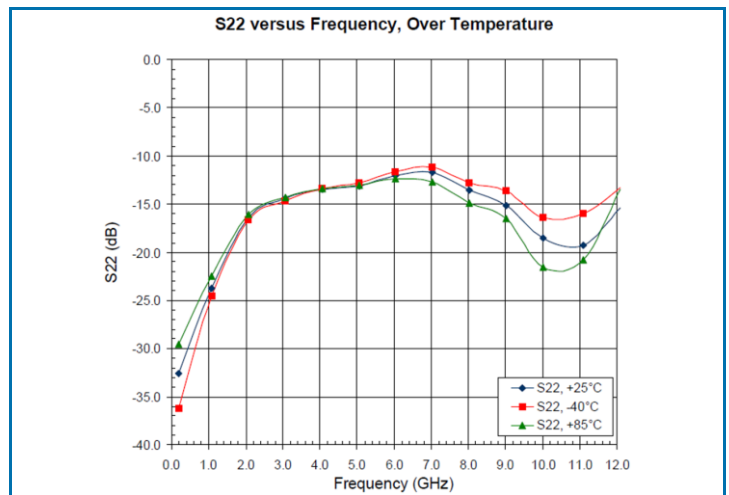
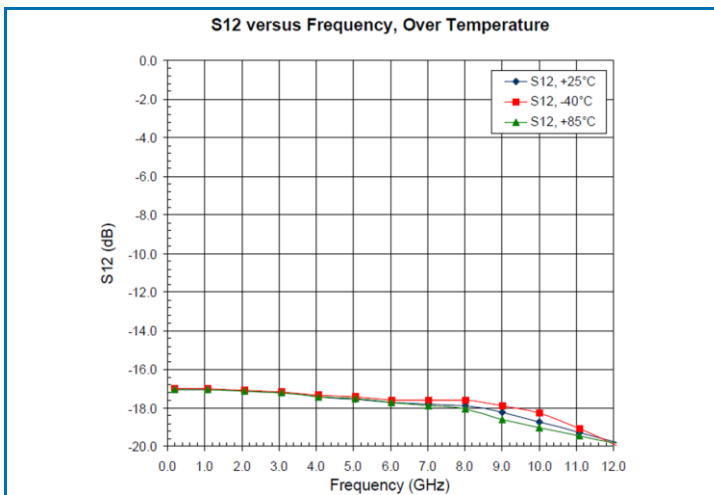
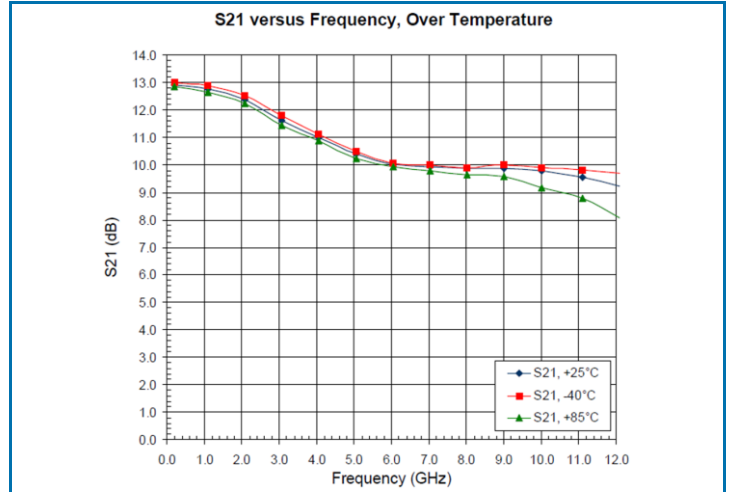
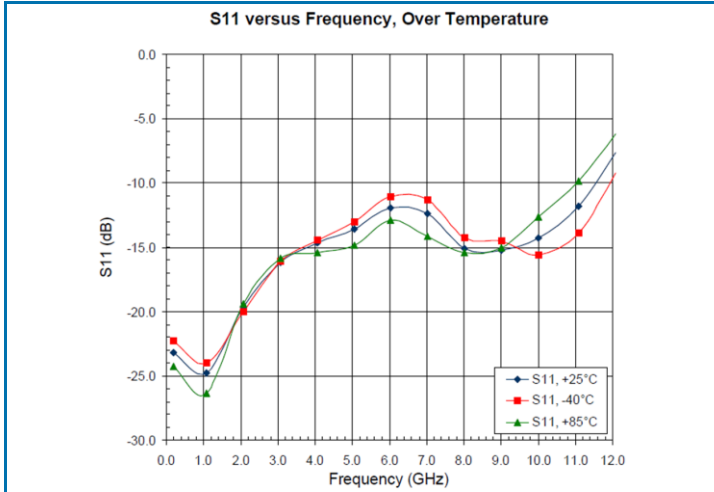

Note: The s-parameter gain results shown above include device performance as well as evaluation board and connector loss variations. The insertion losses of the evaluation board and connectors are as follows:

1GHz to 4GHz = -0.06dB

5GHz to 9GHz = -0.22dB

10GHz to 14GHz = -0.50dB

15GHz to 20GHz = -1.08dB

Looking for pricing, stock, or lifecycle information?

Click below to explore more details on WIN SOURCE:

-  [View NLB-310-T1 on WIN SOURCE](#)
-  [RF Micro Devices Information](#)

Optimize Your Supply Chain with WIN SOURCE Solutions

-  Global Sourcing Solution
-  Obsolete Management
-  Cost Control Management
-  Shortage Management
-  Alternative Solution
-  Excess Inventory Management