



**THE DATASHEET OF  
NBB-402-T1**





### Features

- Reliable, Low-Cost HBT Design
- 15.0dB Gain, +15.8dBm P1dB at 2GHz
- High P1dB of +15.4dBm at 6.0GHz
- Single Power Supply Operation
- 50Ω I/O Matched for High Frequency Use

### Applications

- Narrow and Broadband Commercial and Military Radio Designs
- Linear and Saturated Amplifiers
- Gain Stage or Driver Amplifiers for MW Radio/Optical Designs (PTP/PMP/LMDS/UNII/VSAT/WiFi/Cellular/DWDM)

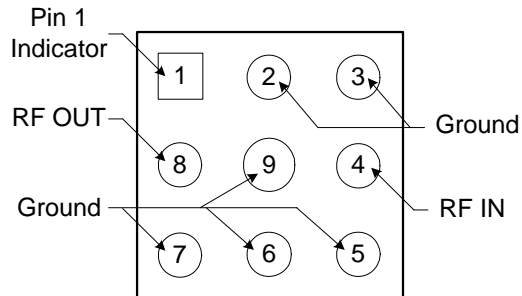

Functional Block Diagram

### Product Description

The NBB-402 cascadable broadband InGaP/GaAs MMIC amplifier is a low-cost, high-performance solution for general purpose RF and microwave amplification needs. This 50Ω gain block is based on a reliable HBT proprietary MMIC design, providing unsurpassed performance for small-signal applications. Designed with an external bias resistor, the NBB-402 provides flexibility and stability. The NBB-402 is packaged in a low-cost, surface-mount ceramic package, providing ease of assembly for high-volume tape-and-reel requirements.

|            |                                                     |
|------------|-----------------------------------------------------|
| NBB-402    | Cascadable Broadband GaAs MMIC Amplifier DC to 8GHz |
| NBB-402-T1 | Tape and Reel, 1000 Pieces                          |
| NBB-402-E  | Fully Assembled Evaluation Board                    |
| NBB-X-K1   | Extended Frequency InGaP Amp Designer's Tool Kit    |

## Absolute Maximum Ratings

| Parameter             | Rating      | Unit |
|-----------------------|-------------|------|
| RF Input Power        | +20         | dBm  |
| Power Dissipation     | 300         | mW   |
| Device Current        | 70          | mA   |
| Channel Temperature   | 150         | °C   |
| Operating Temperature | -45 to +85  | °C   |
| Storage Temperature   | -65 to +150 | °C   |

Exceeding any one or a combination of these limits may cause permanent damage.



**Caution!** ESD sensitive device.

Exceeding any one or a combination of the Absolute Maximum Rating conditions may cause permanent damage to the device. Extended application of Absolute Maximum Rating conditions to the device may reduce device reliability. Specified typical performance or functional operation of the device under Absolute Maximum Rating conditions is not implied.

The information in this publication is believed to be accurate and reliable. However, no responsibility is assumed by RF Micro Devices, Inc. ("RFMD") for its use, nor for any infringement of patents, or other rights of third parties, resulting from its use. No license is granted by implication or otherwise under any patent or patent rights of RFMD. RFMD reserves the right to change component circuitry, recommended application circuitry and specifications at any time without prior notice.



RFMD Green: RoHS compliant per EU Directive 2011/65/EU, halogen free per IEC 61249-2-21, < 1000ppm each of antimony trioxide in polymeric materials and red phosphorus as a flame retardant, and <2% antimony in solder.

## Nominal Operating Parameters

| Parameter                                                    | Specification |            |      | Unit  | Condition                                                                 |
|--------------------------------------------------------------|---------------|------------|------|-------|---------------------------------------------------------------------------|
|                                                              | Min.          | Typ.       | Max. |       |                                                                           |
| <b>Overall</b>                                               |               |            |      |       | $V_D = +3.8V, I_{CC} = 47mA, Z_0 = 50\Omega, T_A = +25^\circ C$           |
| Small Signal Power Gain, S21                                 | 15.0          | 17.1       |      | dB    | f = 0.1GHz to 1.0GHz                                                      |
|                                                              |               | 15.8       |      | dB    | f = 1.0GHz to 4.0GHz                                                      |
|                                                              |               | 14.3       |      | dB    | f = 4.0GHz to 6.0GHz                                                      |
|                                                              |               | 12.0       | 12.5 | dB    | f = 6.0GHz to 8.0GHz                                                      |
| Gain Flatness, GF                                            |               | ±0.8       |      | dB    | f = 0.1GHz to 5.0GHz                                                      |
| Input and Output VSWR                                        |               | 1.45:1     |      |       | f = 0.1GHz to 4.0GHz                                                      |
|                                                              |               | 1.30:1     |      |       | f = 4.0GHz to 8.0GHz                                                      |
|                                                              |               | 1.80:1     |      |       | f = 8.0GHz to 10.0GHz                                                     |
| Bandwidth, BW                                                |               | 6.3        |      | GHz   | BW3 (3dB)                                                                 |
| Output Power at -1dB Compression, P1dB                       |               | 15.8       |      | dBm   | f = 2.0GHz                                                                |
|                                                              |               | 15.4       |      | dBm   | f = 6.0GHz                                                                |
|                                                              |               | 15.5       |      | dBm   | f = 8.0GHz                                                                |
| Noise Figure, NF                                             |               | 4.3        |      | dB    | f = 3.0GHz                                                                |
| Third Order Intercept, IP3                                   |               | +26.0      |      | dBm   | f = 2.0GHz                                                                |
| Reverse Isolation, S12                                       |               | -17.5      |      | dB    | f = 0.1GHz to 12.0GHz                                                     |
| Device Voltage, $V_D$                                        | 3.6           | 3.8        | 4    | V     |                                                                           |
| Gain Temperature Coefficient, $\delta G_T / \delta T$        |               | -0.0015    |      | dB/°C |                                                                           |
| <b>MTTF versus Temperature at <math>I_{CC} = 50mA</math></b> |               |            |      |       |                                                                           |
| Case Temperature                                             |               | 85         |      | °C    |                                                                           |
| Junction Temperature                                         |               | 120.9      |      | °C    |                                                                           |
| MTTF                                                         |               | >1,000,000 |      | hours |                                                                           |
| <b>Thermal Resistance</b>                                    |               |            |      |       |                                                                           |
| $\theta_{JC}$                                                |               | 196        |      | °C/W  | $\frac{J_T - T_{CASE}}{V_D \cdot I_{CC}} = \theta_{JC} (^\circ C / Watt)$ |

## Pin Names and Descriptions

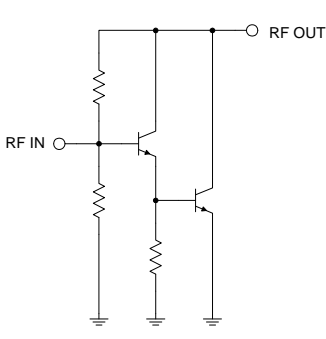
| Pin | Name   | Description                                                                                                                                                                                                                                                                                                                                                                                                                                                                                                                                                                                                                                                                                                                                                                                                                                                                                                                                                                | Interface Schematic                                                                  |
|-----|--------|----------------------------------------------------------------------------------------------------------------------------------------------------------------------------------------------------------------------------------------------------------------------------------------------------------------------------------------------------------------------------------------------------------------------------------------------------------------------------------------------------------------------------------------------------------------------------------------------------------------------------------------------------------------------------------------------------------------------------------------------------------------------------------------------------------------------------------------------------------------------------------------------------------------------------------------------------------------------------|--------------------------------------------------------------------------------------|
| 1   | GND    | Ground connection. For best performance, keep traces physically short and connect immediately to ground plane.                                                                                                                                                                                                                                                                                                                                                                                                                                                                                                                                                                                                                                                                                                                                                                                                                                                             |                                                                                      |
| 2   | GND    | Same as pin 1.                                                                                                                                                                                                                                                                                                                                                                                                                                                                                                                                                                                                                                                                                                                                                                                                                                                                                                                                                             |                                                                                      |
| 3   | GND    | Same as pin 1.                                                                                                                                                                                                                                                                                                                                                                                                                                                                                                                                                                                                                                                                                                                                                                                                                                                                                                                                                             |                                                                                      |
| 4   | RF IN  | RF input pin. This pin is NOT internally DC blocked. A DC blocking capacitor, suitable for the frequency of operation, should be used in most applications. DC coupling of the input is not allowed, because this will override the internal feedback loop and cause temperature instability.                                                                                                                                                                                                                                                                                                                                                                                                                                                                                                                                                                                                                                                                              |                                                                                      |
| 5   | GND    | Same as pin 1.                                                                                                                                                                                                                                                                                                                                                                                                                                                                                                                                                                                                                                                                                                                                                                                                                                                                                                                                                             |                                                                                      |
| 6   | GND    | Same as pin 1.                                                                                                                                                                                                                                                                                                                                                                                                                                                                                                                                                                                                                                                                                                                                                                                                                                                                                                                                                             |                                                                                      |
| 7   | GND    | Same as pin 1.                                                                                                                                                                                                                                                                                                                                                                                                                                                                                                                                                                                                                                                                                                                                                                                                                                                                                                                                                             |                                                                                      |
| 8   | RF OUT | RF output and bias pin. Biasing is accomplished with an external series resistor and choke inductor to $V_{CC}$ . The resistor is selected to set the DC current into this pin to a desired level. The resistor value is determined by the following equation:<br><br>$R = \frac{(V_{CC} - V_{DEVICE})}{I_{CC}}$ <p>Care should also be taken in the resistor selection to ensure that the current into the part never exceeds maximum datasheet operating current over the planned operating temperature. This means that a resistor between the supply and this pin is always required, even if a supply near 5.0V is available, to provide DC feedback to prevent thermal runaway. Alternatively, a constant current supply circuit may be implemented. Because DC is present on this pin, a DC blocking capacitor, suitable for the frequency of operation, should be used in most applications. The supply side of the bias network should also be well bypassed.</p> |  |
| 9   | GND    | Same as pin 1.                                                                                                                                                                                                                                                                                                                                                                                                                                                                                                                                                                                                                                                                                                                                                                                                                                                                                                                                                             |                                                                                      |

## Package Drawing

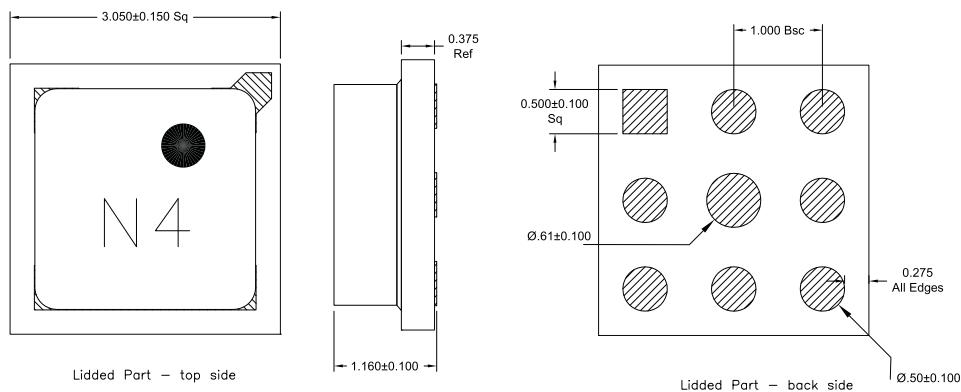

## Recommended PCB Layout

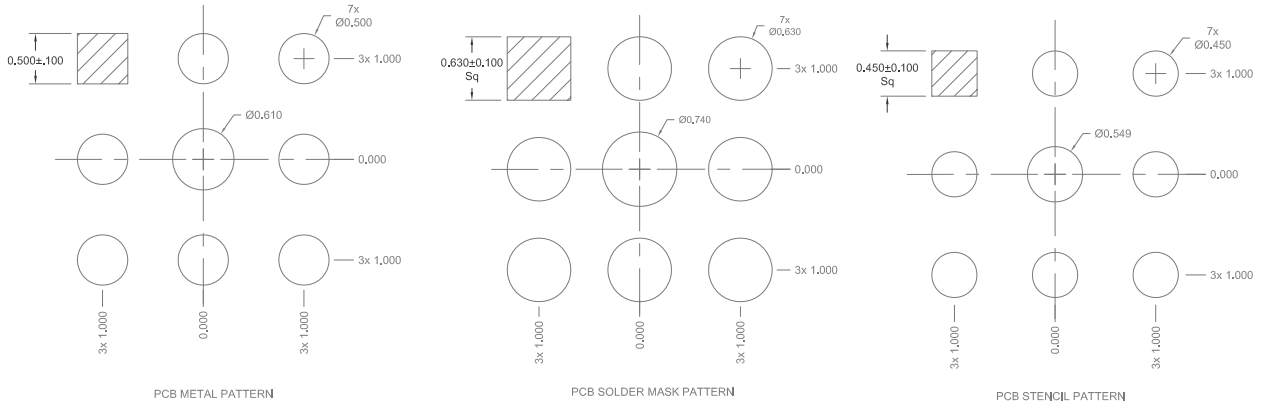

## Typical Bias Configuration

Application notes related to biasing circuit, device footprint, and thermal considerations are available on request.

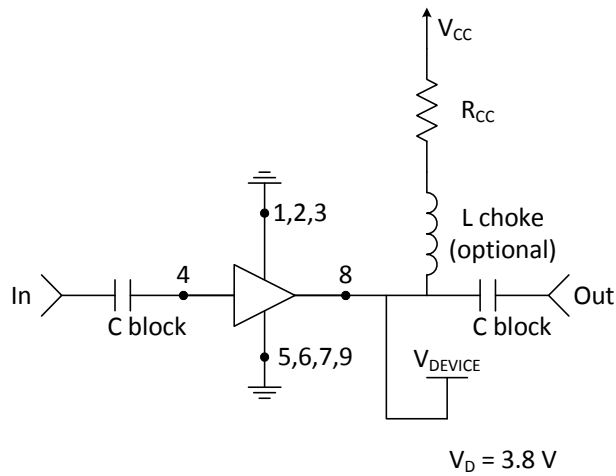

| Recommended Bias Resistor Values     |    |    |     |     |     |     |
|--------------------------------------|----|----|-----|-----|-----|-----|
| Supply Voltage, $V_{CC}$ (V)         | 5  | 8  | 10  | 12  | 15  | 20  |
| Bias Resistor, $R_{CC}$ ( $\Omega$ ) | 22 | 81 | 122 | 162 | 222 | 322 |

## Application Notes

### Die Attach

The die attach process mechanically attaches the die to the circuit substrate. In addition, it electrically connects the ground to the trace on which the chip is mounted, and establishes the thermal path by which heat can leave the chip.

### Wire Bonding

Electrical connections to the chip are made through wire bonds. Either wedge or ball bonding methods are acceptable practices for wire bonding.

### Assembly Procedure

Epoxy or eutectic die attach are both acceptable attachment methods. Top and bottom metallization are gold. Conductive silver-filled epoxies are recommended. This procedure involves the use of epoxy to form a joint between the backside gold of the chip and the metallized area of the substrate. A 150°C cure for 1 hour is necessary. Recommended epoxy is Ablebond 84-1LMI from Ablestik.

### Bonding Temperature (Wedge or Ball)

It is recommended that the heater block temperature be set to 160°C ± 10°C.

## Extended Frequency InGaP Amplifier Designer's Tool Kit NBB-X-K1

This tool kit was created to assist in the design-in of the RFMD NBB- and NLB-series InGaP HBT gain block amplifiers. Each tool kit contains the following.

- 5 each NBB-300, NBB-310 and NBB-400 Ceramic Micro-X Amplifiers
- 5 each NLB-300, NLB-310 and NLB-400 Plastic Micro-X Amplifiers
- 2 Broadband Evaluation Boards and High Frequency SMA Connectors
- Broadband Bias Instructions and Specification Summary Index for ease of operation



## Tape and Reel Dimensions

All Dimensions in Millimeters

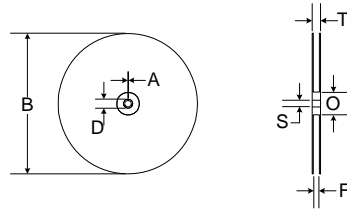

| 330 mm (13") REEL |                       |        | Micro-X, MPGA  |                     |
|-------------------|-----------------------|--------|----------------|---------------------|
|                   | ITEMS                 | SYMBOL | SIZE (mm)      | SIZE (inches)       |
| FLANGE            | Diameter              | B      | 330 +0.25/-4.0 | 13.0 +0.079/-0.158  |
|                   | Thickness             | T      | 18.4 MAX       | 0.724 MAX           |
|                   | Space Between Flange  | F      | 12.4 +2.0      | 0.488 +0.08         |
| HUB               | Outer Diameter        | O      | 102.0 REF      | 4.0 REF             |
|                   | Spindle Hole Diameter | S      | 13.0 +0.5/-0.2 | 0.512 +0.020/-0.008 |
|                   | Key Slit Width        | A      | 1.5 MIN        | 0.059 MIN           |
|                   | Key Slit Diameter     | D      | 20.2 MIN       | 0.795 MIN           |

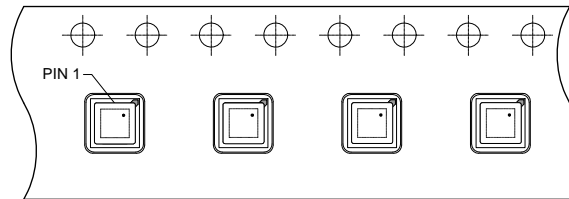

User Direction of Feed

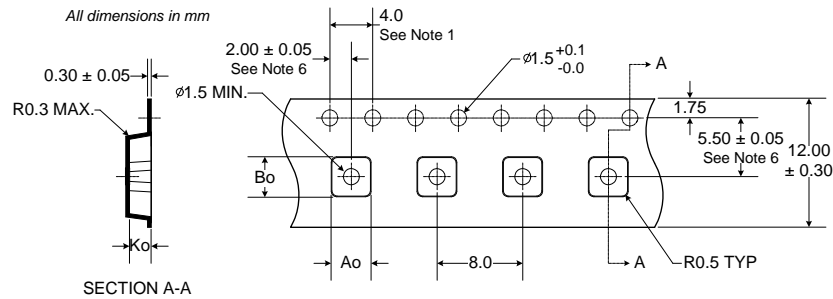

**NOTES:**

- 10 sprocket hole pitch cumulative tolerance  $\pm 0.2$ .
- Camber not to exceed 1 mm in 100 mm.
- Material: PS+C
- Ao and Bo measured on a plane 0.3 mm above the bottom of the pocket.
- Ko measured from a plane on the inside bottom of the pocket to the surface of the carrier.
- Pocket position relative to sprocket hole measured as true position of pocket, not pocket hole.

Ao = 3.6 MM  
Bo = 3.6 MM  
Ko = 1.7 MM

Note: The s-parameter gain results shown below include device performance as well as evaluation board and connector loss variations. The insertion losses of the evaluation board and connectors are as follows:

- 1GHz to 4GHz = -0.06dB
- 5GHz to 9GHz = -0.22dB
- 10GHz to 14GHz = -0.50dB
- 15GHz to 20GHz = -1.08dB

**S11 versus Frequency**

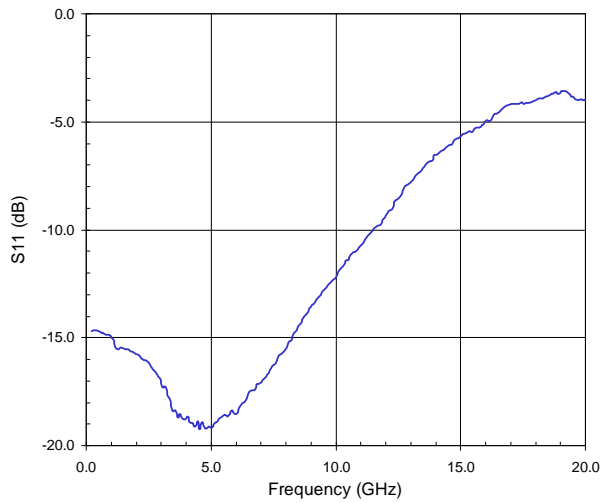

**S12 versus Frequency**

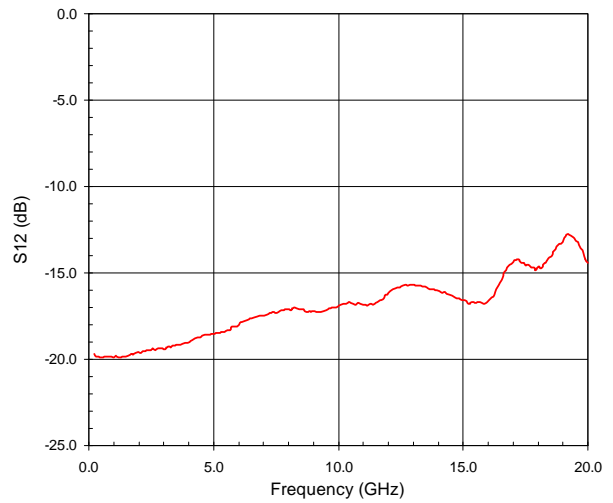

**S21 versus Frequency**

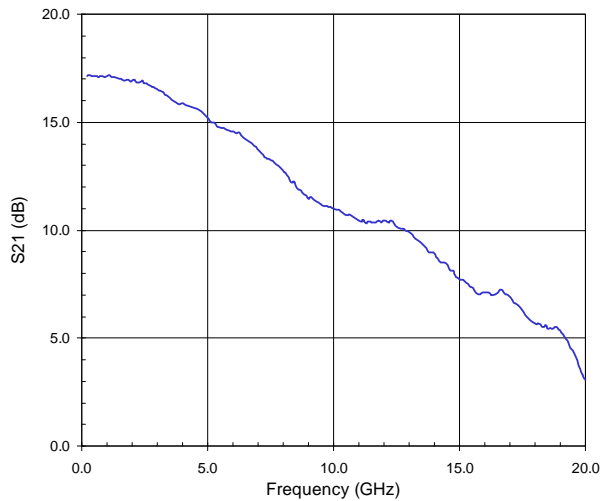

**S22 versus Frequency**

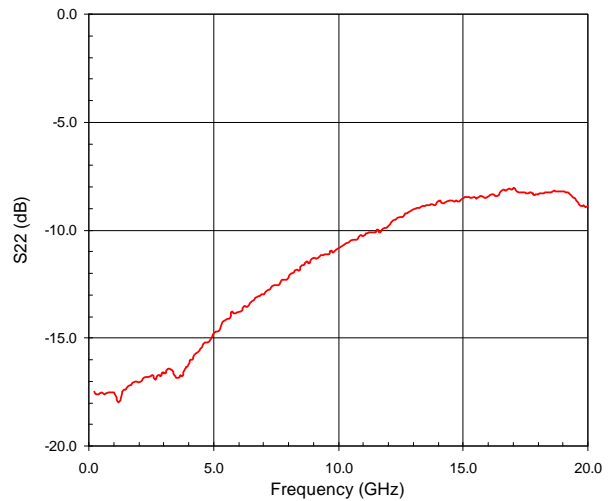

Device Voltage versus Amplifier Current

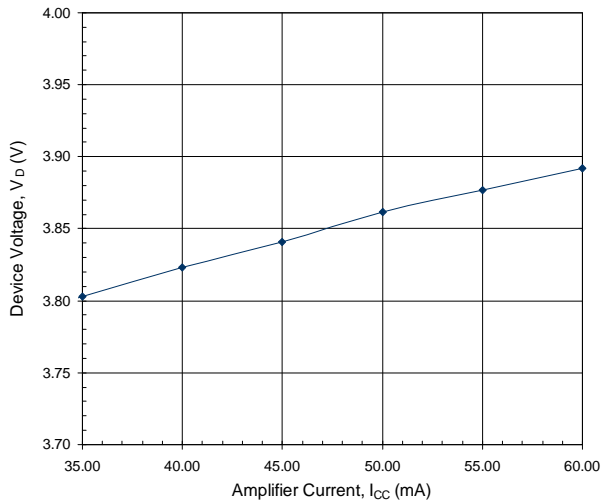

P1dB versus Frequency at 25°C

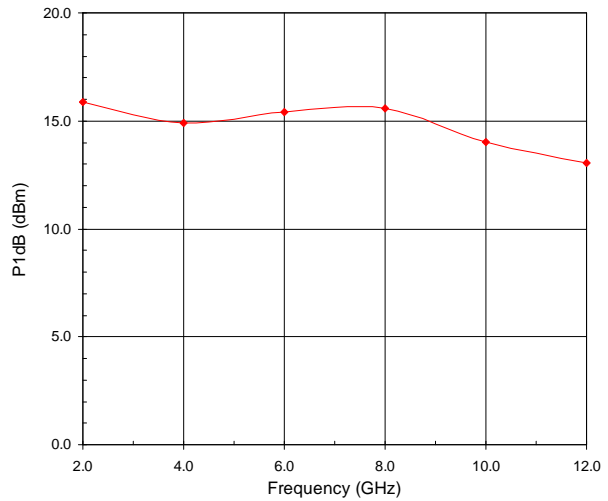

$P_{OUT}$ /Gain versus  $P_{IN}$  at 2 GHz

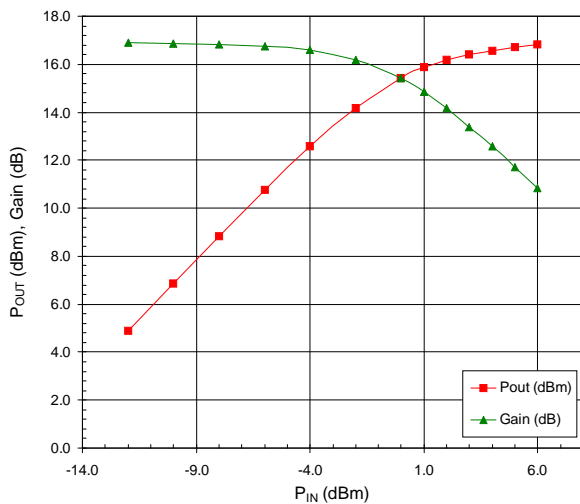

$P_{OUT}$ /Gain versus  $P_{IN}$  at 6 GHz

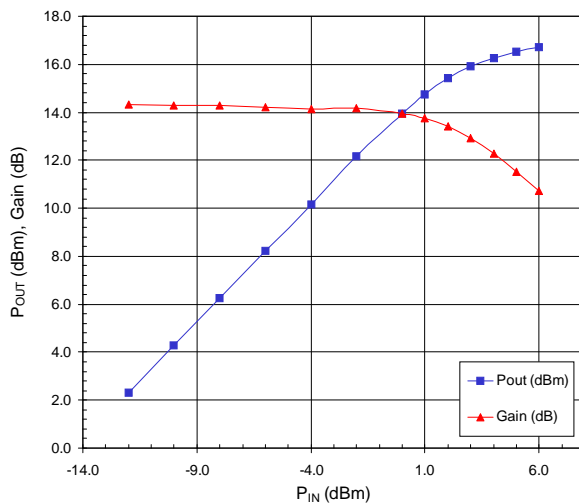

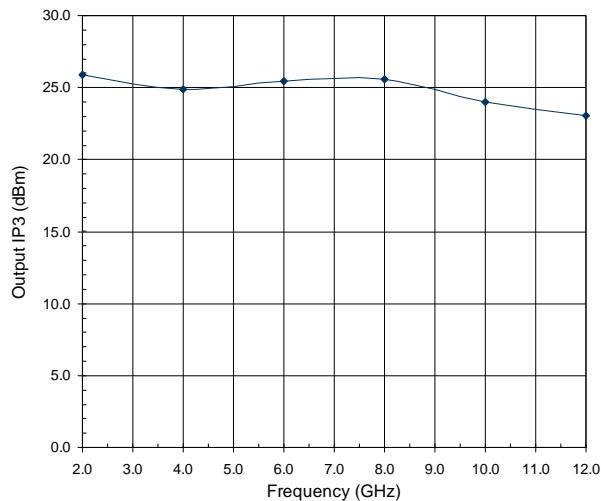

Third Order Intercept versus Frequency at 25°C



## Looking for pricing, stock, or lifecycle information?

Click below to explore more details on WIN SOURCE:

-  [View NBB-402-T1 on WIN SOURCE](#)
-  [RF Micro Devices Information](#)

## Optimize Your Supply Chain with WIN SOURCE Solutions

-  Global Sourcing Solution
-  Obsolete Management
-  Cost Control Management
-  Shortage Management
-  Alternative Solution
-  Excess Inventory Management