



# MAX3535E/MXL1535E

## +3V to +5V, 2500VRMS Isolated RS-485/RS-422 Transceivers with ±15kV ESD Protection

### General Description

The MAX3535E/MXL1535E isolated RS-485/RS-422 full-duplex transceivers provide 2500VRMS of galvanic isolation between the RS-485/RS-422 side and the processor or control logic side. These devices allow fast, 1000kbps communication across an isolation barrier when the common-mode voltages (i.e., the ground potentials) on either side of the barrier are subject to large differences. Isolation is achieved through integrated high-voltage capacitors. The MAX3535E/MXL1535E also feature a 420kHz transformer driver that allows power transfer to the RS-485 side using an external transformer.

The MAX3535E/MXL1535E include one differential driver, one receiver, and internal circuitry to send the RS-485 signals and control signals across the isolation barrier (including the isolation capacitors). The MAX3535E/MXL1535E RS-485 receivers are 1/8 unit load, allowing up to 256 devices on the same bus.

The MAX3535E/MXL1535E feature true fail-safe circuitry. The driver outputs and the receiver inputs are protected from ±15kV electrostatic discharge (ESD) on the interface side, as specified in the Human Body Model (HBM).

The MAX3535E/MXL1535E feature driver slew-rate select that minimizes electromagnetic interference (EMI) and reduces reflections. The driver outputs are short-circuit and overvoltage protected. Other features are hot-swap capability and isolation-barrier fault detection.

The MAX3535E operates with a single +3V to +5.5V power supply. The improved secondary supply range of the MAX3535E allows the use of step-down transformers for +5V operation, resulting in considerable power savings. The MXL1535E operates with a single +4.5V to +5.5V power supply. The MXL1535E is a function/pin-compatible improvement of the LTC1535. The MAX3535E/MXL1535E are available over the commercial 0°C to +70°C and extended -40°C to +85°C temperature ranges.

### Applications

- Isolated RS-485 Systems
- Systems with Large Common-Mode Voltages
- Industrial-Control Local Area Networks
- Telecommunications Systems

### Features

- ◆ 2500VRMS RS-485 Bus Isolation Using On-Chip High-Voltage Capacitors
- ◆ 1000kbps Full-Duplex RS-485/RS-422 Communication
- ◆ +3V to +5.5V Power-Supply Voltage Range (MAX3535E)
- ◆ +4.5V to +5.5V Power-Supply Voltage Range (MXL1535E)
- ◆ 1/8 Unit Receiver Load, Allowing 256 Devices on Bus
- ◆ ±15kV ESD Protection Using HBM
- ◆ Pin-Selectable Slew-Rate Limiting Controls EMI
- ◆ Hot-Swap-Protected Driver-Enable Input
- ◆ Undervoltage Lockout
- ◆ Isolation-Barrier Fault Detection
- ◆ Short-Circuit Protected
- ◆ Thermal Shutdown
- ◆ Open-Line and Shorted-Line Fail-Safe Receiver Inputs

### Ordering Information

PART	TEMP RANGE	PIN-PACKAGE	POWER-SUPPLY RANGE (V)
MAX3535ECWI	0°C to +70°C	28 Wide SO	+3.0 to +5.5
MAX3535EEWI	-40°C to +85°C	28 Wide SO	+3.0 to +5.5
MXL1535ECWI	0°C to +70°C	28 Wide SO	+4.5 to +5.5
MXL1535EEWI	-40°C to +85°C	28 Wide SO	+4.5 to +5.5

### Pin Configuration

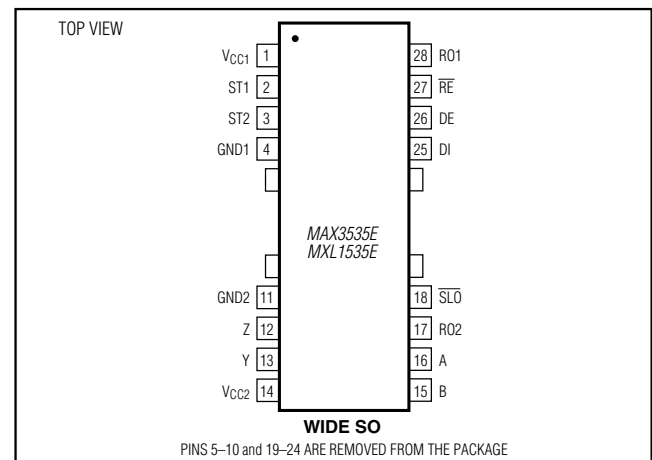

For pricing, delivery, and ordering information, please contact Maxim Direct at 1-888-629-4642, or visit Maxim's website at [www.maximintegrated.com](http://www.maximintegrated.com).

# MAX3535E/MXL1535E

## +3V to +5V, 2500VRMS Isolated RS-485/RS-422 Transceivers with ±15kV ESD Protection

### ABSOLUTE MAXIMUM RATINGS

Logic Side—All Voltages Referenced to GND1.

V<sub>CC1</sub> .....-0.3V to +6V

RE, DE, DI .....-0.3V to +6V

RO1, ST1, ST2 .....-0.3V to (V<sub>CC1</sub> + 0.3V)

Isolated Side—All Voltages Referenced to GND2.

V<sub>CC2</sub> .....-0.3V to +8V

SLO .....-0.3V to (V<sub>CC2</sub> + 0.3V)

A, B .....±14V

RO2 .....-0.3V to the lower of (V<sub>CC2</sub> + 0.3V) and +3.4V

Y, Z .....-8V to +13V

Digital Outputs Maximum Current

RO1, RO2 .....±20mA

Y, Z Maximum Current .....Short-Circuit Protected

ST1, ST2 Maximum Current .....±300mA

Continuous Power Dissipation (T<sub>A</sub> = +70°C)

28-Pin Wide SO

(derate 9.5mW/°C above +70°C) .....750mW

Operating Temperature Range

MXL1535ECWI, MAX3535ECWI .....0°C to +70°C

MXL1535EEWI, MAX3535EEWI .....-40°C to +85°C

Junction Temperature .....+150°C

Storage Temperature Range .....-65°C to +150°C

Lead Temperature (soldering, 10s) .....+300°C

Stresses beyond those listed under "Absolute Maximum Ratings" may cause permanent damage to the device. These are stress ratings only, and functional operation of the device at these or any other conditions beyond those indicated in the operational sections of the specifications is not implied. Exposure to absolute maximum rating conditions for extended periods may affect device reliability.

### DC ELECTRICAL CHARACTERISTICS TABLE (MAX3535E)

(V<sub>CC1</sub> = +3.0V to +5.5V, V<sub>CC2</sub> = +3.13V to +7.5V, T<sub>A</sub> = -40°C to +85°C, unless otherwise noted. Typical values are at V<sub>CC1</sub> = +3.3V, V<sub>CC2</sub> = +5V, T<sub>A</sub> = +25°C.)

PARAMETER	SYMBOL	CONDITIONS	MIN	TYP	MAX	UNITS
<b>LOGIC-SIDE SUPPLY (V<sub>CC1</sub>, GND1)</b>						
Logic-Side Supply Voltage	V <sub>CC1</sub>		3.0		5.5	V
Logic-Side Supply Current	I <sub>CC1</sub>	Transformer not driven, ST1 and ST2 unconnected, RE = low, DE = high, f <sub>DATA</sub> = 0, RO1 = no load		5.9	13	mA
V <sub>CC1</sub> Undervoltage-Lockout Falling Trip	V <sub>UVL1</sub>		2.53	2.69	2.85	V
V <sub>CC1</sub> Undervoltage-Lockout Rising Trip	V <sub>UVH1</sub>		2.63	2.80	2.97	V
<b>LOGIC INPUTS (DI, DE, RE)</b>						
Input High Voltage, DE, DI, RE	V <sub>IH</sub>	V <sub>IH</sub> is measured with respect to GND1	2.0			V
Input Low Voltage, DE, DI, RE	V <sub>IL</sub>	V <sub>IL</sub> is measured with respect to GND1			0.8	V
Logic-Side Input Current, DE, DI	I <sub>INC</sub>				±2	µA
<b>LOGIC OUTPUTS (RO1, RE)</b>						
Receiver-Output High Voltage (RO1)	V <sub>RO1H</sub>	I <sub>SOURCE</sub> = 4mA, V <sub>CC1</sub> = +4.5V	3.7			V
		I <sub>SOURCE</sub> = 4mA, V <sub>CC1</sub> = +3V	2.4			
Receiver-Output Low Voltage (RO1)	V <sub>RO1L</sub>	I <sub>SINK</sub> = 4mA, V <sub>CC1</sub> = +4.5V			0.4	V
		I <sub>SINK</sub> = 4mA, V <sub>CC1</sub> = +3V			0.4	
Receiver-Output (RO1) Leakage Current	I <sub>OZR</sub>	RE = high, V <sub>CC1</sub> = +5.5V, 0 ≤ V <sub>RO1</sub> ≤ V <sub>CC1</sub>			±1	µA
RE Low Output Current for Fault Detect	I <sub>OL</sub>	RE = +0.4V, fault not asserted	40	60	80	µA

# MAX3535E/MXL1535E

## +3V to +5V, 2500VRMS Isolated RS-485/RS-422 Transceivers with ±15kV ESD Protection

### DC ELECTRICAL CHARACTERISTICS TABLE (MAX3535E) (continued)

(V<sub>CC1</sub> = +3.0V to +5.5V, V<sub>CC2</sub> = +3.13V to +7.5V, T<sub>A</sub> = -40°C to +85°C, unless otherwise noted. Typical values are at V<sub>CC1</sub> = +3.3V, V<sub>CC2</sub> = +5V, T<sub>A</sub> = +25°C.)

PARAMETER	SYMBOL	CONDITIONS	MIN	TYP	MAX	UNITS
$\overline{RE}$ High Output Current for Fault Detect	I <sub>OH</sub>	$\overline{RE} = V_{CC1} - 0.5V$ , fault asserted	-140	-100	-60	μA
<b>TRANSFORMER DRIVER (ST1, ST2)</b>						
DC-Converter Switching Frequency (ST1, ST2)	f <sub>sw</sub>	ST1, ST2, not loaded	290	460	590	kHz
DC-Converter Total Impedance R <sub>OH</sub> + R <sub>OL</sub> (ST1, ST2)	R <sub>OHL</sub>	V <sub>CC1</sub> = +4.5V, Figure 13		1.6	2.6	Ω
		V <sub>CC1</sub> = +3V, Figure 13		1.8	2.9	
ST1, ST2 Duty Cycle		ST1, ST2, not loaded	44	50	56	%
<b>ISOLATED-SIDE SUPPLY (V<sub>CC2</sub>, GND2)</b>						
Isolated-Side Supply Voltage	V <sub>CC2</sub>		3.13		7.50	V
Isolated-Side Supply Current	I <sub>CC2</sub>	f <sub>DATA</sub> = 0, $\overline{SLO}$ floating, R <sub>O2</sub> = no load, A, B floating, Figure 1	R <sub>L</sub> = 27Ω	56	70	mA
			R <sub>L</sub> = ∞	10	16	
V <sub>CC2</sub> Undervoltage-Lockout Falling Trip	V <sub>UVL2</sub>		2.68	2.85	3.02	V
V <sub>CC2</sub> Undervoltage-Lockout Rising Trip	V <sub>UVH2</sub>		2.77	2.95	3.13	V
<b>DRIVER OUTPUTS (Y, Z)</b>						
Driver-Output High Voltage	V <sub>DOH</sub>	No load, V <sub>DOH</sub> is measured with respect to GND2			4	V
Differential Driver Output	V <sub>OD</sub>	R <sub>L</sub> = 50Ω (RS-422), V <sub>CC2</sub> = +3.13V, Figure 1	2.0	2.35		V
		R <sub>L</sub> = 27Ω (RS-485), V <sub>CC2</sub> = +3.13V, Figure 1	1.5	1.95		
Driver Common-Mode Output Voltage	V <sub>OC</sub>	R <sub>L</sub> = 27Ω or 50Ω, V <sub>OC</sub> is measured with respect to GND2, Figure 1	1.0		3.0	V
Change in Magnitude of Driver Differential Output Voltage for Complementary Output States	ΔV <sub>OD</sub>	R <sub>L</sub> = 27Ω or 50Ω, Figure 1			±0.2	V
Change in Magnitude of Driver Common-Mode Output Voltage for Complementary Output States	ΔV <sub>OC</sub>	R <sub>L</sub> = 27Ω or 50Ω, Figure 1			±0.2	V
Driver Short-Circuit Output Current	I <sub>OSD</sub>	Driver enabled (DE = 1) DI = high, V <sub>Y</sub> > -7V DI = low, V <sub>Z</sub> > -7V	-250			mA
		Driver enabled (DE = 1) DI = high, V <sub>Z</sub> < +12V DI = low, V <sub>Y</sub> < +12V			+250	

# MAX3535E/MXL1535E

## +3V to +5V, 2500VRMS Isolated RS-485/RS-422 Transceivers with ±15kV ESD Protection

### DC ELECTRICAL CHARACTERISTICS TABLE (MAX3535E) (continued)

(V<sub>CC1</sub> = +3.0V to +5.5V, V<sub>CC2</sub> = +3.13V to +7.5V, T<sub>A</sub> = -40°C to +85°C, unless otherwise noted. Typical values are at T<sub>A</sub> = +25°C, V<sub>CC1</sub> = +3.3V, V<sub>CC2</sub> = +5V).

PARAMETER	SYMBOL	CONDITIONS		MIN	TYP	MAX	UNITS
Driver Short-Circuit Foldback Output Current	I <sub>OSFD</sub>	Driver enabled (DE = 1)	DI = high -7V < V <sub>Y</sub> < min[(V <sub>CC2</sub> - 1V) + 2V]			-25	μA
			DI = low -7V < V <sub>Z</sub> < min[(V <sub>CC2</sub> - 1V) + 2V]				
			DI = high +1V < V <sub>Z</sub> < +12V	+25			
			DI = low +1V < V <sub>Y</sub> < +12V				
<b>SLEW-RATE SELECT (SLO)</b>							
Input High Voltage $\overline{\text{SLO}}$	V <sub>IHS</sub>	V <sub>IHS</sub> is measured with respect to GND2		3.0			V
Input Low Voltage $\overline{\text{SLO}}$	V <sub>ILS</sub>	V <sub>ILS</sub> is measured with respect to GND2				1.0	V
$\overline{\text{SLO}}$ Pullup Resistor	R <sub>SLO</sub>	V <sub>SLO</sub> = +3V			100		kΩ
<b>RECEIVER INPUTS (A, B)</b>							
Receiver Input Current	I <sub>AB</sub>	V <sub>A</sub> or V <sub>B</sub> = +12V				+125	μA
		V <sub>A</sub> or V <sub>B</sub> = -7V				-100	
Receiver Differential Threshold Voltage	V <sub>TH</sub>	-7V ≤ V <sub>CM</sub> ≤ +12V		-200	-90	-10	mV
Receiver-Input Hysteresis	ΔV <sub>TH</sub>	-7V ≤ V <sub>CM</sub> ≤ +12V, T <sub>A</sub> = 0°C to +70°C		10	30	70	mV
		-7V ≤ V <sub>CM</sub> ≤ +12V, T <sub>A</sub> = -40°C to +85°C		5	30	70	
Receiver-Input Resistance	R <sub>IN</sub>	-7V ≤ V <sub>CM</sub> ≤ +12V (Note 1)		96		200	kΩ
Receiver-Input Open Circuit Voltage	V <sub>OAB</sub>				2.6		V
<b>RECEIVER OUTPUT (RO2)</b>							
Receiver-Output (RO2) High Voltage	V <sub>RO2H</sub>	I <sub>SOURCE</sub> = 4mA, V <sub>CC2</sub> = +3.13V		2.4			V
Receiver-Output (RO2) Low Voltage	V <sub>RO2L</sub>	I <sub>SINK</sub> = 4mA, V <sub>CC2</sub> = +3.13V				0.4	V
<b>ISOLATION</b>							
Isolation Voltage (Notes 2, 3)	V <sub>ISO</sub>	60s		2500			V <sub>RMS</sub>
		1s		3000			
Isolation Resistance	R <sub>ISO</sub>	T <sub>A</sub> = +25°C, V <sub>ISO</sub> = 50V (Note 3)		100	10,000		MΩ
Isolation Capacitance	C <sub>ISO</sub>	T <sub>A</sub> = +25°C			2		pF
ESD Protection		Human Body Model (A, B, Y, Z)			±15		kV

# MAX3535E/MXL1535E

## +3V to +5V, 2500VRMS Isolated RS-485/RS-422 Transceivers with ±15kV ESD Protection

### SWITCHING ELECTRICAL CHARACTERISTICS (MAX3535E)

(V<sub>CC1</sub> = +3.0V to +5.5V, V<sub>CC2</sub> = +3.13V to +7.5V, R<sub>L</sub> = 27Ω, C<sub>L</sub> = 50pF, T<sub>A</sub> = -40°C to +85°C, unless otherwise noted. Typical values are at V<sub>CC1</sub> = +3.3V, V<sub>CC2</sub> = +5V, T<sub>A</sub> = +25°C.)

PARAMETER	SYMBOL	CONDITIONS	MIN	TYP	MAX	UNITS
Data Sample Jitter	t <sub>J</sub>	Figure 6		220	285	ns
Maximum Data Rate	f <sub>DATA</sub>	t <sub>J</sub> = 25% of data cell, receiver and driver, S <sub>LO</sub> = high (Note 4)	877	1136		kbps
Self-Oscillating Frequency	f <sub>SOS</sub>	S <sub>LO</sub> = high, Figure 5	250	450		kHz
		S <sub>LO</sub> = low, Figure 5	200	375		
Driver-Differential Output Delay Time	t <sub>DD</sub>	S <sub>LO</sub> = high, Figures 2, 6		490	855	ns
		S <sub>LO</sub> = low, Figures 2, 6		850	1560	
Driver-Differential Output Transition Time	t <sub>TD</sub>	S <sub>LO</sub> = high, Figures 2, 6		30	100	ns
		S <sub>LO</sub> = low, Figures 2, 6	120	220	1000	
Driver-Output Enable Time	t <sub>PZL</sub> , t <sub>PZH</sub>	S <sub>LO</sub> = high, DI = high or low, Figures 3, 7		730	1400	ns
Driver-Output Disable Time	t <sub>PHZ</sub> , t <sub>PLZ</sub>	S <sub>LO</sub> = high, DI = high or low, Figures 3, 7		720	1300	ns
Receiver-Propagation Delay Time to RO1	t <sub>PLH1</sub> , t <sub>PHL1</sub>	Figures 4, 8		440	855	ns
Receiver-Propagation Delay Time to RO2	t <sub>PLH2</sub> , t <sub>PHL2</sub>	Figures 4, 8		40		ns
RO1, RO2 Rise or Fall Time	t <sub>R</sub> , t <sub>F</sub>	Figures 4, 8		40		ns
Receiver-Output Enable Time RO1	t <sub>ZL</sub> , t <sub>ZH</sub>	Figures 4, 9		30		ns
Receiver-Output Disable Time RO1	t <sub>LZ</sub> , t <sub>HZ</sub>	Figures 4, 9		30		ns
Initial Startup Time (from Internal Communication Fault)		(Note 5)		1200		ns
Internal Communication Timeout Fault Time		(Note 5)		1200		ns

# MAX3535E/MXL1535E

## +3V to +5V, 2500V<sub>RMS</sub> Isolated RS-485/RS-422 Transceivers with ±15kV ESD Protection

### ELECTRICAL CHARACTERISTICS (MXL1535E)

(V<sub>CC1</sub> = +4.5V to +5.5V, V<sub>CC2</sub> = +4.5V to +7.5V, T<sub>A</sub> = -40°C to +85°C, unless otherwise noted. Typical values are at V<sub>CC1</sub> = +5V, V<sub>CC2</sub> = +5V, T<sub>A</sub> = +25°C.)

PARAMETER	SYMBOL	CONDITIONS	MIN	TYP	MAX	UNITS
Logic-Side Supply Voltage	V <sub>CC1</sub>		4.5		5.5	V
Isolated-Side Supply Voltage	V <sub>CC2</sub>		4.5		7.5	V
Logic-Side Supply Current	I <sub>CC1</sub>	Transformer not driven, ST1 and ST2 unconnected, $\overline{RE}$ = low, DE = high, f <sub>DATA</sub> = 0, RO1 = no load		5.9	13	mA
Isolated-Side Supply Current	I <sub>CC2</sub>	f <sub>DATA</sub> = 0, $\overline{SLO}$ floating, RO2 = no load, A, B floating, Figure 1	R <sub>L</sub> = 27Ω	56	70	mA
			R <sub>L</sub> = ∞	10	16	
Differential Driver Output	V <sub>OD</sub>	R <sub>L</sub> = 50Ω (RS-422), V <sub>CC2</sub> = +4.5V, Figure 1	2.0	3.0	V	
		R <sub>L</sub> = 27Ω (RS-485), V <sub>CC2</sub> = +4.5V, Figure 1	1.5	2.5		
Driver Output High Voltage	V <sub>DOH</sub>	No load, V <sub>DOH</sub> is measured with respect to GND2			5.0	V
Driver Common-Mode Output Voltage	V <sub>OC</sub>	R <sub>L</sub> = 27Ω or 50Ω, V <sub>OC</sub> is measured with respect to GND2, Figure 1	1.0		3.0	V
Change in Magnitude of Driver Differential Output Voltage for Complementary Output States	ΔV <sub>OD</sub>	R <sub>L</sub> = 27Ω or 50Ω, Figure 1			±0.2	V
Change in Magnitude of Driver Common-Mode Output Voltage for Complementary Output States	ΔV <sub>OC</sub>	R <sub>L</sub> = 27Ω or 50Ω, Figure 1			±0.2	V
Driver Short-Circuit Output Current	I <sub>OSD</sub>	Driver enabled (DE = 1) DI = high, V <sub>Y</sub> > -7V DI = low, V <sub>Z</sub> > -7V	-250		+250	mA
		Driver enabled (DE = 1) DI = high, V <sub>Z</sub> < +12V DI = low, V <sub>Y</sub> < +12V				
Driver Short-Circuit Foldback Output Current	I <sub>OSFD</sub>	Driver enabled (DE = 1) DI = high -7V < V <sub>Y</sub> < min[(V <sub>CC2</sub> - 1V) + 2V] DI = low -7V < V <sub>Z</sub> < min[(V <sub>CC2</sub> - 1V) + 2V]			-25	mA
		Driver enabled (DE = 1) DI = high +1V < V <sub>Z</sub> < +12V DI = low +1V < V <sub>Y</sub> < +12V	+25			

# MAX3535E/MXL1535E

## +3V to +5V, 2500VRMS Isolated RS-485/RS-422 Transceivers with ±15kV ESD Protection

### ELECTRICAL CHARACTERISTICS (MXL1535E) (continued)

( $V_{CC1} = +4.5V$  to  $+5.5V$ ,  $V_{CC2} = +4.5V$  to  $+7.5V$ ,  $T_A = -40^{\circ}C$  to  $+85^{\circ}C$ , unless otherwise noted. Typical values are at  $V_{CC1} = +5V$ ,  $V_{CC2} = +5V$ ,  $T_A = +25^{\circ}C$ .)

PARAMETER	SYMBOL	CONDITIONS	MIN	TYP	MAX	UNITS
Input High Voltage, DE, DI, $\overline{RE}$	$V_{IH}$	$V_{IH}$ is measured with respect to GND1	2.0	1.45		V
Input High Voltage, $\overline{SLO}$	$V_{IHS}$	$V_{IHS}$ is measured with respect to GND2	4.0	2.1		V
Input Low Voltage, DE, DI, $\overline{RE}$	$V_{IL}$	$V_{IL}$ is measured with respect to GND1		1.45	0.8	V
Input Low Voltage, $\overline{SLO}$	$V_{ILS}$	$V_{ILS}$ is measured with respect to GND2		2.1	1.0	V
Logic-Side Input Current, DE, DI	$I_{INC}$				±2	μA
Receiver Input Current	$I_{AB}$	$V_A$ or $V_B = +12V$			+0.25	mA
		$V_A$ or $V_B = -7V$			-0.20	
Receiver Differential Threshold Voltage	$V_{TH}$	$-7V \leq V_{CM} \leq +12V$	-200	-90	-10	mV
Receiver-Input Hysteresis	$\Delta V_{TH}$	$-7V \leq V_{CM} \leq +12V$ , $T_A = 0^{\circ}C$ to $+70^{\circ}C$	10	30	70	mV
		$-7V \leq V_{CM} \leq +12V$ , $T_A = -40^{\circ}C$ to $+85^{\circ}C$	5	30	70	
Receiver-Input Resistance	$R_{IN}$	$-7V \leq V_{CM} \leq +12V$ (Note 1)	96	140	200	kΩ
Receiver-Input Open-Circuit Voltage	$V_{OAB}$			2.6		V
Receiver-Output High Voltage (RO1)	$V_{RO1H}$	$I_{SOURCE} = 4mA$ , $V_{CC1} = +4.5V$	3.7	4.3		V
Receiver-Output Low Voltage (RO1)	$V_{RO1L}$	$I_{SINK} = 4mA$ , $V_{CC1} = +4.5V$		0.4	0.8	V
Driver-Output Leakage Current	$I_{OZ}$	DE = low $-7V < V_Y < +12V$ , $-7V < V_Z < +12V$		±30		μA
Driver-Output Leakage Current	$I_{OZ}$	DE = low $-7V < V_Y < +12V$ , $-7V < V_Z < +12V$		±30	±100	μA
Receiver-Output (RO2) High Voltage	$V_{RO2H}$	$I_{SOURCE} = 4mA$ , $V_{CC2} = +4.5V$	2.8	3.4		V
Receiver-Output (RO2) Low Voltage	$V_{RO2L}$	$I_{SINK} = 4mA$ , $V_{CC2} = +4.5V$		0.4	0.8	V
DC-Converter Switching Frequency (ST1, ST2)	f <sub>sw</sub>	ST1, ST2 not loaded	290	460	590	kHz

# MAX3535E/MXL1535E

## +3V to +5V, 2500V<sub>RMS</sub> Isolated RS-485/RS-422 Transceivers with ±15kV ESD Protection

### ELECTRICAL CHARACTERISTICS (MXL1535E) (continued)

(V<sub>CC1</sub> = +4.5V to +5.5V, V<sub>CC2</sub> = +4.5V to +7.5V, T<sub>A</sub> = -40°C to +85°C, unless otherwise noted. Typical values are at V<sub>CC1</sub> = +5V, V<sub>CC2</sub> = +5V, T<sub>A</sub> = +25°C.)

PARAMETER	SYMBOL	CONDITIONS	MIN	TYP	MAX	UNITS
DC-Converter Impedance High ST1, ST2	R <sub>OH</sub>	Figure 13		4	6	Ω
DC-Converter Impedance Low ST1, ST2	R <sub>OL</sub>	Figure 13		2.5	5	Ω
$\overline{RE}$ Low Output Current for Fault Detect	I <sub>OL</sub>	$\overline{RE}$ = sink current, $\overline{RE}$ = +0.4V, fault not asserted	-40	-50	-80	μA
$\overline{RE}$ High Output Current for Fault Detect	I <sub>OH</sub>	$\overline{RE}$ = source current, $\overline{RE}$ = +V <sub>CC1</sub> - 0.5V, fault asserted	60	100	140	μA
V <sub>CC2</sub> Undervoltage-Lockout Falling Trip	V <sub>UVL2</sub>		2.68	2.85	3.02	V
V <sub>CC2</sub> Undervoltage-Lockout Rising Trip	V <sub>UVH2</sub>		2.77	2.95	3.13	V
V <sub>CC1</sub> Undervoltage-Lockout Falling Trip	V <sub>UVL1</sub>		2.53	2.69	2.85	V
V <sub>CC1</sub> Undervoltage-Lockout Rising Trip	V <sub>UVH1</sub>		2.63	2.80	2.97	V
Isolation Voltage (Note 2)	V <sub>ISO</sub>	60s	2500			V <sub>RMS</sub>
		1s	3000			
$\overline{SLO}$ Pullup Resistor	R <sub>SLO</sub>	V <sub>SLO</sub> = +3V		100		kΩ

# MAX3535E/MXL1535E

## +3V to +5V, 2500VRMS Isolated RS-485/RS-422 Transceivers with ±15kV ESD Protection

### SWITCHING ELECTRICAL CHARACTERISTICS (MXL1535E)

(V<sub>CC1</sub> = +4.5V to +5.5V, V<sub>CC2</sub> = +4.5V to +7.5V, R<sub>L</sub> = 27Ω, C<sub>L</sub> = 50pF, T<sub>A</sub> = -40°C to +85°C, unless otherwise noted. Typical values are at V<sub>CC1</sub> = +5V, V<sub>CC2</sub> = +5V, T<sub>A</sub> = +25°C.)

PARAMETER	SYMBOL	CONDITIONS	MIN	TYP	MAX	UNITS
Data Sample Jitter	t <sub>J</sub>	Figure 6		220	285	ns
Max Baud Rate	f <sub>MAX</sub>	$\overline{SLO}$ = high, Figure 5, (Note 6)	250	450		kBd
Driver-Differential Output Delay Time	t <sub>DD</sub>	$\overline{SLO}$ = high, Figures 2, 6		430	855	ns
		$\overline{SLO}$ = low, Figures 2, 6		850	1560	
Driver-Differential Output Transition Time	t <sub>TD</sub>	$\overline{SLO}$ = high, V <sub>CC2</sub> = +4.5V		45	100	ns
		$\overline{SLO}$ = low, V <sub>CC2</sub> = +4.5V	150	260	1000	
Driver-Output Enable Time	t <sub>PZL</sub> , t <sub>PZH</sub>	$\overline{SLO}$ = high, DI = high or low, Figure 3, 7		730	1400	ns
Driver-Output Disable Time	t <sub>PHZ</sub> , t <sub>PLZ</sub>	$\overline{SLO}$ = high, DI = high or low, Figures 3, 7		720	1300	ns
Receiver-Propagation Delay Time to RO1	t <sub>PLH1</sub> , t <sub>PHL1</sub>	Figures 4, 8		440	855	ns
Receiver-Propagation Delay Time to RO2	t <sub>PLH2</sub> , t <sub>PHL2</sub>	Figures 4, 8		40		ns
RO1, RO2 Rise or Fall Time	t <sub>R</sub> , t <sub>F</sub>	Figures 4, 8		40		ns
Receiver-Output Enable Time RO1	t <sub>ZL</sub> , t <sub>ZH</sub>	Figures 4, 9		30		ns
Receiver-Output Disable Time RO1	t <sub>LZ</sub> , t <sub>HZ</sub>	Figures 4, 9		30		ns
Initial Startup Time (from Internal Communication Fault)		(Note 5)		1200		ns
Internal Communication Timeout Fault Time		(Note 5)		1200		ns
ST1, ST2 Duty Cycle		0°C to +70°C			56	%
		-40°C to +85°C			57	
ESD Protection		Human Body Model (A, B, Y, Z)		±15		kV

**Note 1:** Receiver inputs are 96kΩ minimum resistance, which is 1/8 unit load.

**Note 2:** 60s test result is guaranteed by correlation from 1s result.

**Note 3:** V<sub>ISO</sub> is the voltage difference between GND1 and GND2.

**Note 4:** The maximum data rate is specified using the maximum jitter value according to the formula: data rate = 1 / (4t<sub>J</sub>). See the *Skew* section for more information.

**Note 5:** Initial startup time is the time for communication to recover after a fault condition. Internal communication timeout fault time is the time before a fault is indicated on RE, after internal communication has stopped.

**Note 6:** Bd = 2 bits.

# MAX3535E/MXL1535E

## +3V to +5V, 2500V<sub>RMS</sub> Isolated RS-485/RS-422 Transceivers with ±15kV ESD Protection

### Typical Operating Characteristics

( $V_{CC1} = +5V$ ,  $C_L = 50pF$  (Figure 1), unless otherwise noted.)

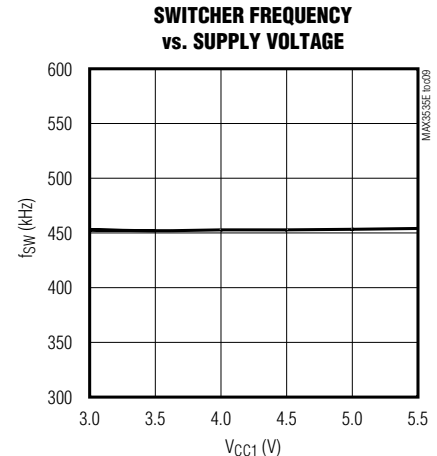
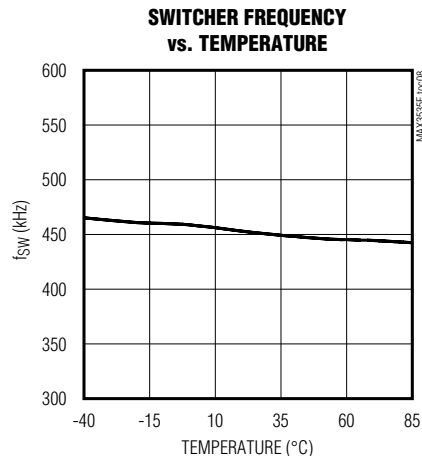
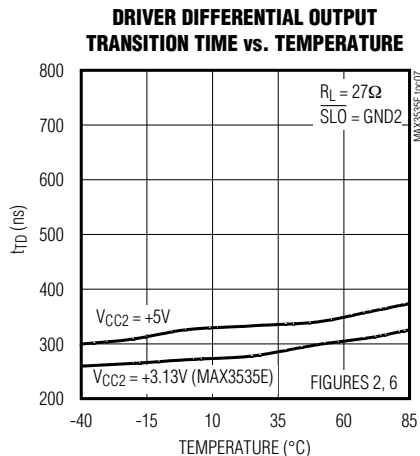
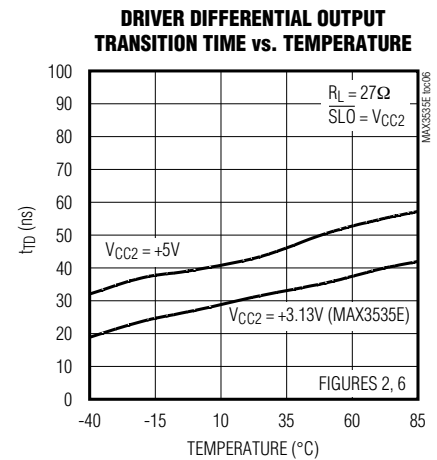
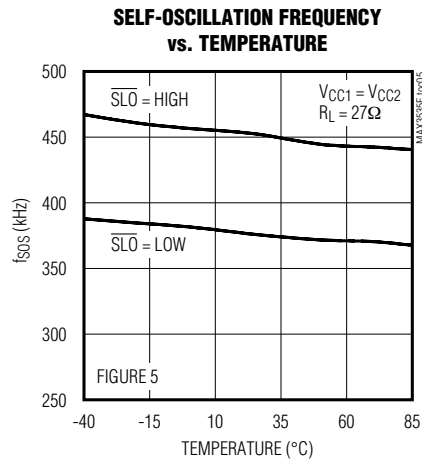
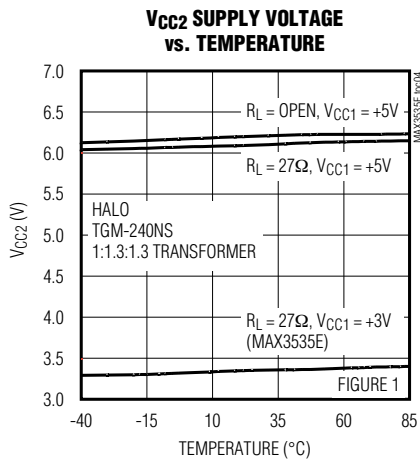
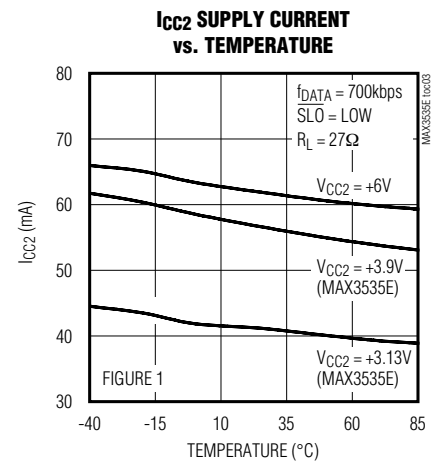
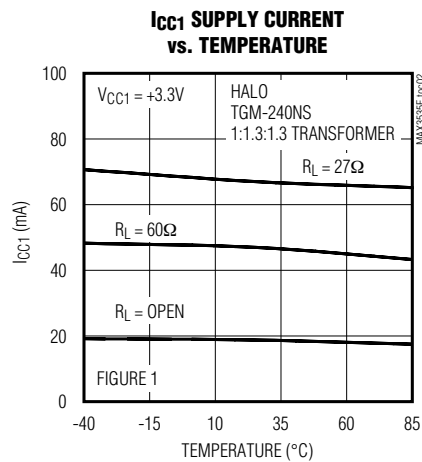
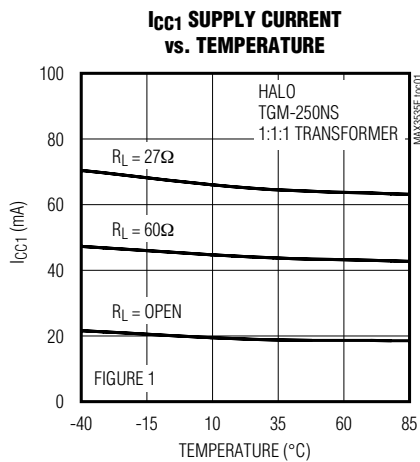

# MAX3535E/MXL1535E

## +3V to +5V, 2500VRMS Isolated RS-485/RS-422 Transceivers with ±15kV ESD Protection

### Typical Operating Characteristics (continued)

( $V_{CC1} = +5V$ ,  $C_L = 50pF$  (Figure 1), unless otherwise noted.)

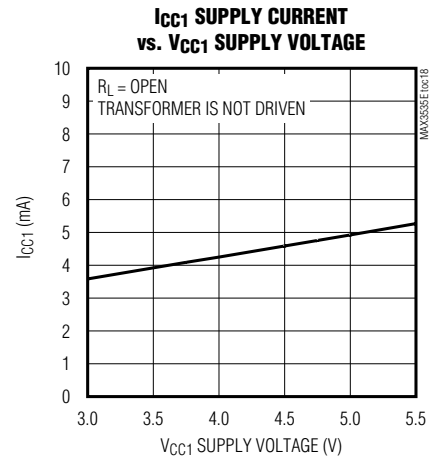
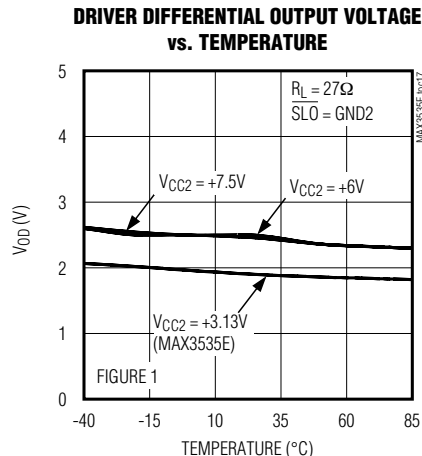
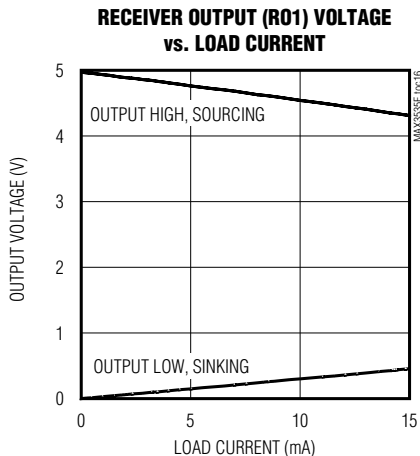
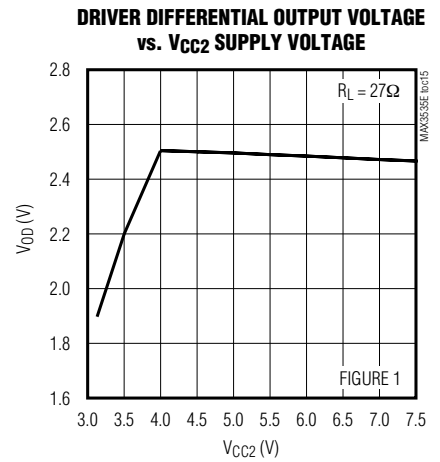
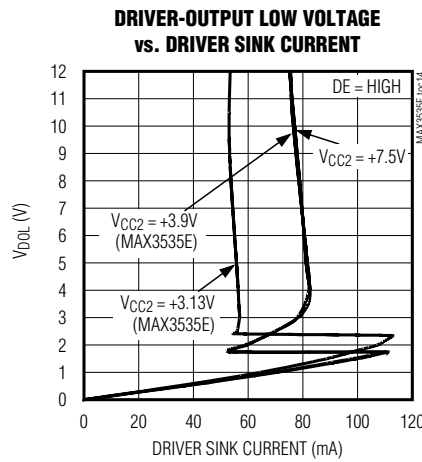
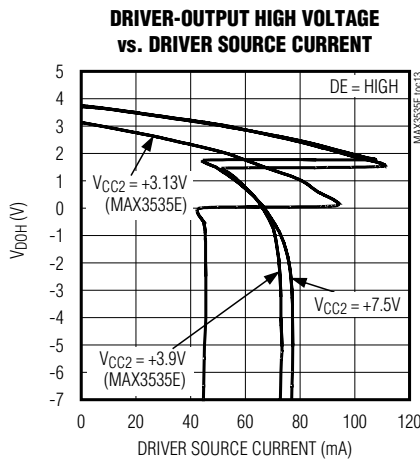
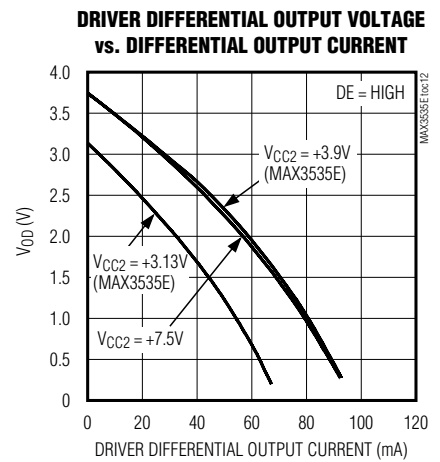
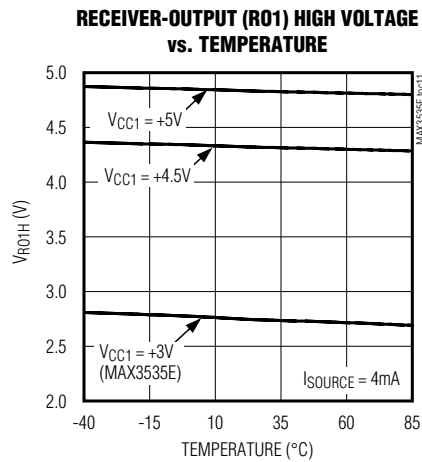
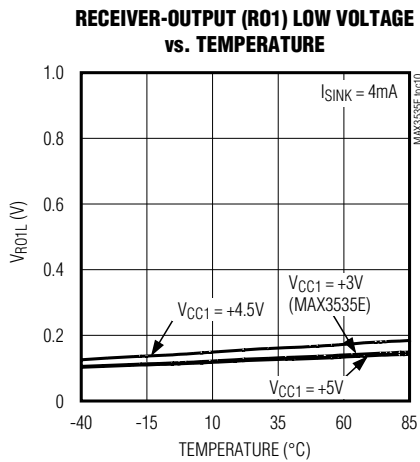

# MAX3535E/MXL1535E

## +3V to +5V, 2500VRMS Isolated RS-485/RS-422 Transceivers with $\pm 15kV$ ESD Protection

### Typical Operating Characteristics (continued)

( $V_{CC1} = +5V$ ,  $C_L = 50pF$  (Figure 1), unless otherwise noted.)

**RECEIVER (RO1) PROPAGATION DELAY ( $t_{PLH1}$ )**

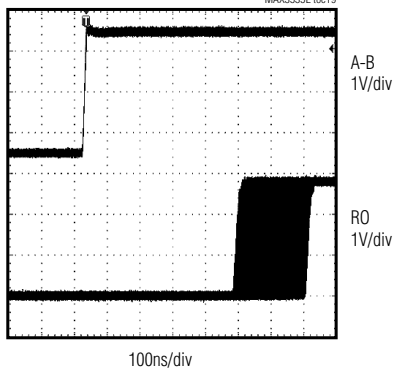

**DRIVER PROPAGATION DELAY (SLO = LOW)**

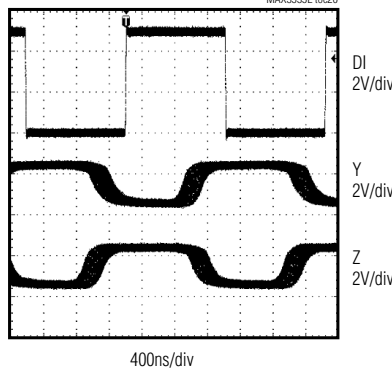

**DRIVER PROPAGATION DELAY (SLO = HIGH)**

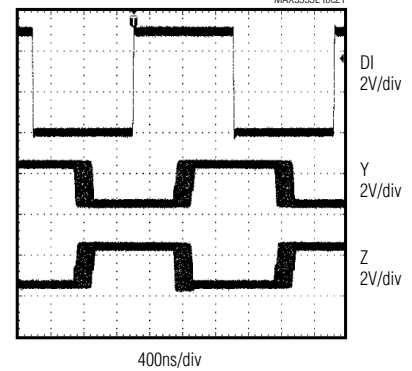

**JITTER vs. TEMPERATURE**

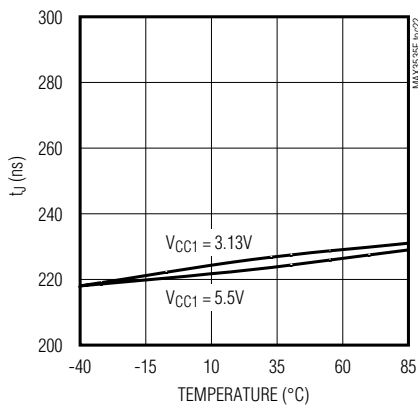

**DRIVER ENABLE TIME PLUS JITTER**

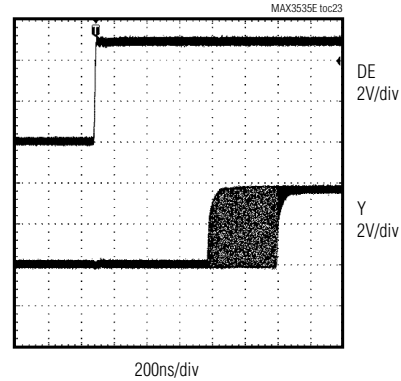

**DRIVER DISABLE TIME PLUS JITTER**

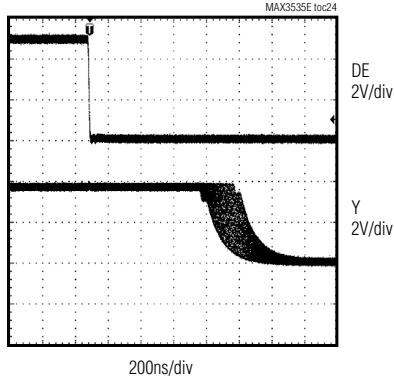

**RECEIVER (RO1) PROPAGATION DELAY ( $t_{PHL1}$ )**

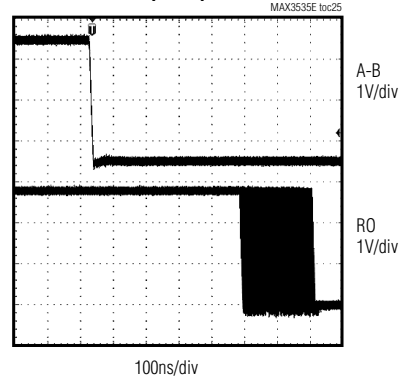

# MAX3535E/MXL1535E

## +3V to +5V, 2500VRMS Isolated RS-485/RS-422 Transceivers with ±15kV ESD Protection

### Pin Description

PIN	NAME	ISOLATION SIDE	FUNCTION
1	VCC1	Logic	Logic-Side/Transformer-Driver Power Input. Bypass VCC1 to GND1 with 10μF and 0.1μF capacitors.
2	ST1	Logic	Transformer-Driver Phase 1 Power Output. Connect ST1 to isolation-transformer primary to send power to isolation side of barrier.
3	ST2	Logic	Transformer-Driver Phase 2 Power Output. Connect ST2 to isolation-transformer primary to send power to isolation side of barrier.
4	GND1	Logic	Logic-Side Ground. For isolated operation do not connect to GND2.
5–10, 19–24	—	—	Removed from Package
11	GND2	Isolated	Isolation-Side Ground. For isolated operation do not connect to GND1.
12	Z	Isolated	RS-485/RS-422 Inverting Driver Output. Output floats when DE is low or in a barrier fault event. (See the <i>Detailed Description</i> section for more information.)
13	Y	Isolated	RS-485/RS-422 Noninverting Driver Output. Output floats when DE is low or in a barrier fault event. (See the <i>Detailed Description</i> section for more information.)
14	VCC2	Isolated	Isolated-Side Power Input. Connect VCC2 to the rectified output of transformer secondary. Bypass VCC2 to GND2 with 10μF and 0.1μF capacitors.
15	B	Isolated	RS-485/RS-422 Differential-Receiver Inverting Input
16	A	Isolated	RS-485/RS-422 Differential-Receiver Noninverting Input
17	RO2	Isolated	Isolated-Side Receiver Output. RO2 is always enabled. RO2 goes high if A - B > -10mV. RO2 goes low if A - B < -200mV. Fail-safe circuitry causes RO2 to go high when A and B float or are shorted.
18	$\overline{\text{SLO}}$	Isolated	Driver Slew-Rate Control Logic Input. Connect $\overline{\text{SLO}}$ to GND2 for data rates up to 400kbps. Connect $\overline{\text{SLO}}$ to VCC2 or leave floating for high data rates.
25	DI	Logic	Driver Input. Pull DI low (high) to force driver output Y low (high) and driver output Z high (low).
26	DE	Logic	Driver-Enable Input. The driver outputs are enabled and follow the driver input (DI) when DE is high. When DE is floated, the driver is disabled. DE does not affect whether the receiver is on or off.
27	$\overline{\text{RE}}$	Logic	Receiver-Output Enable and Fault Current Output. The receiver output (RO1) is enabled and follows the differential-receiver inputs, A and B, when $\overline{\text{RE}}$ is low, otherwise RO1 floats. $\overline{\text{RE}}$ does not affect RO2 and does not disable the driver. The asserted fault output is a pullup current, otherwise $\overline{\text{RE}}$ shows a pulldown current.
28	RO1	Logic	Receiver Output. RO1 is enabled when $\overline{\text{RE}}$ is low. RO1 goes high if A - B > -10mV. RO1 goes low if A - B < -200mV. Fail-safe circuitry causes RO1 to go high when A and B float or are shorted.

# MAX3535E/MXL1535E

## +3V to +5V, 2500V<sub>RMS</sub> Isolated RS-485/RS-422 Transceivers with ±15kV ESD Protection

### Test Circuits

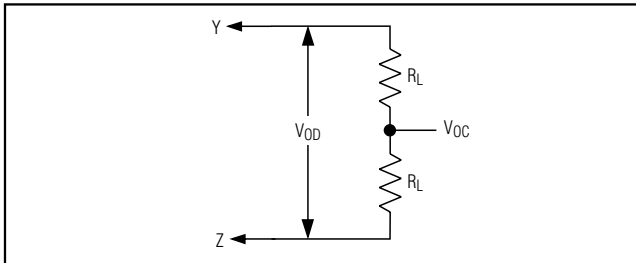

Figure 1. Driver DC Test Load

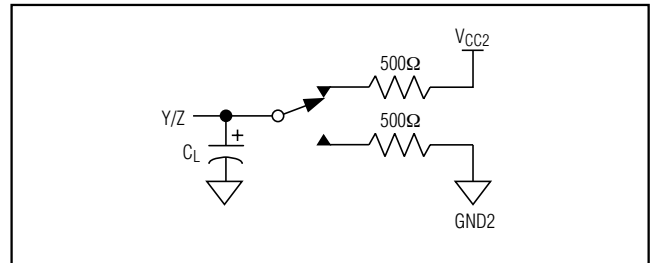

Figure 3. Driver Timing Test Load

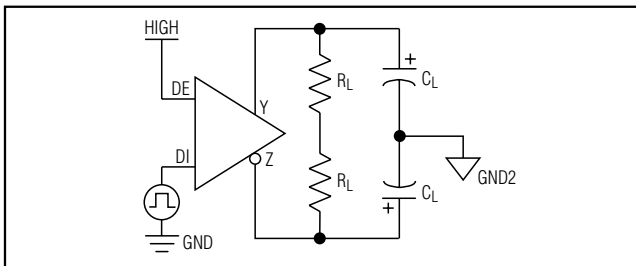

Figure 2. Driver Timing Test Circuit

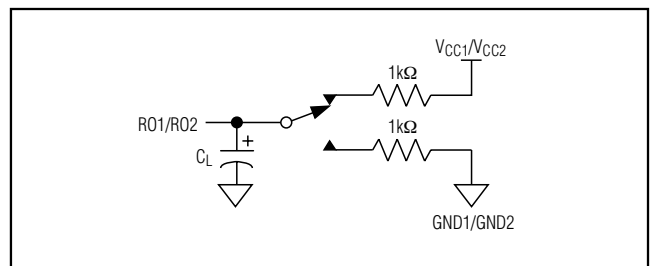

Figure 4. Receiver Timing Test Load

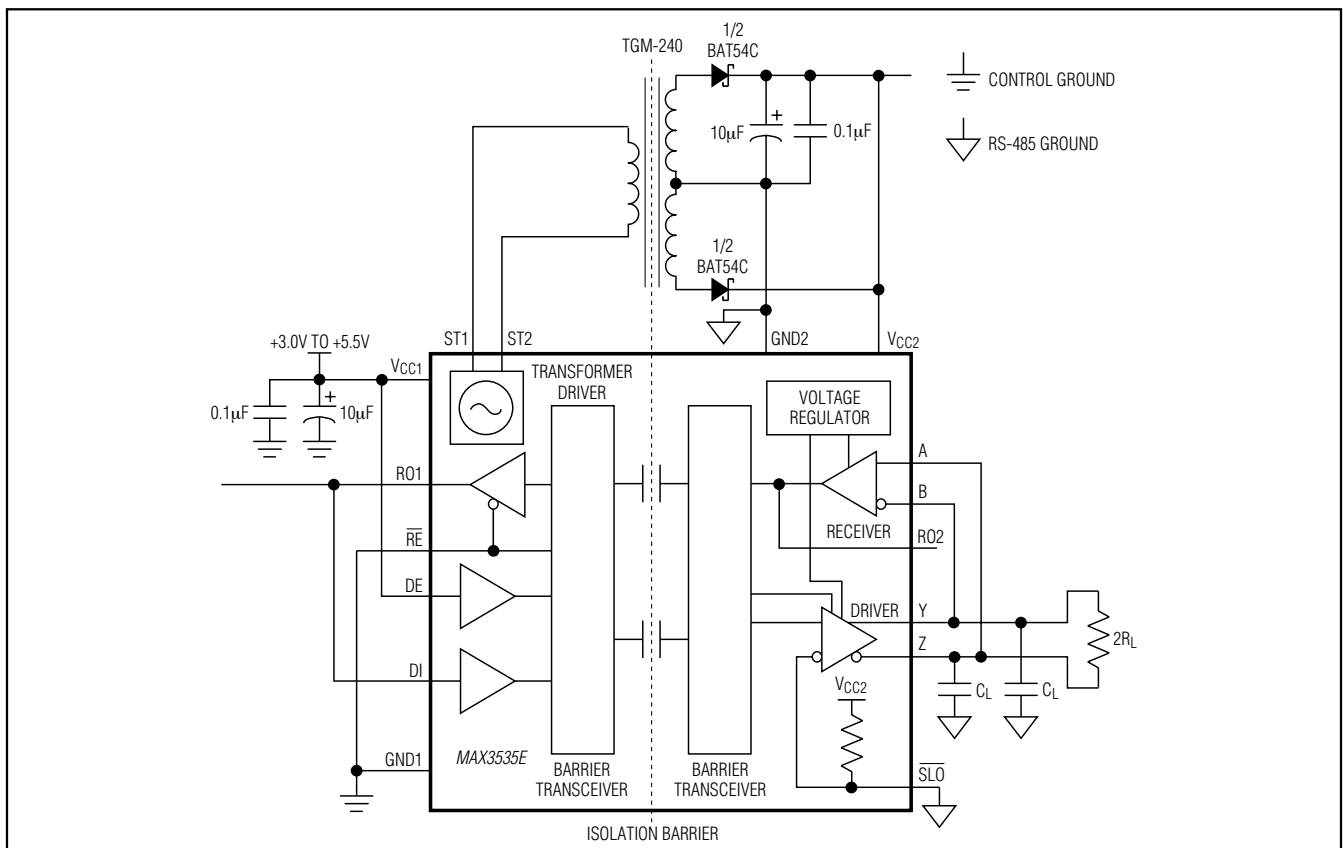

Figure 5. Self-Oscillating Configuration

# MAX3535E/MXL1535E

## +3V to +5V, 2500VRMS Isolated RS-485/RS-422 Transceivers with ±15kV ESD Protection

### Switching Waveforms

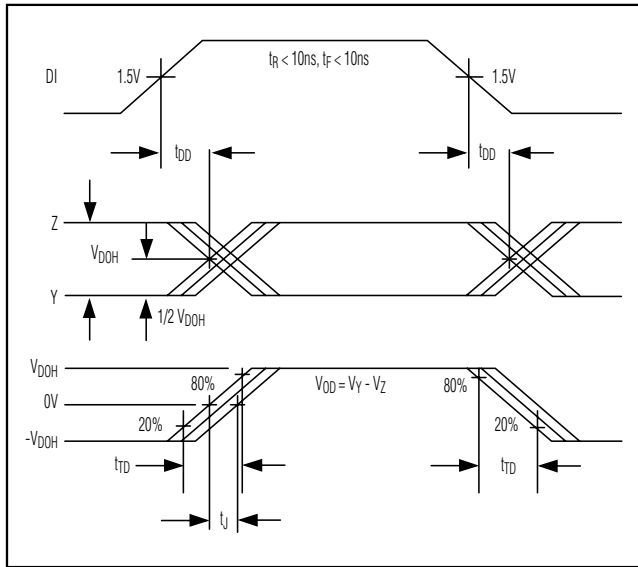

Figure 6. Driver Propagation Delay

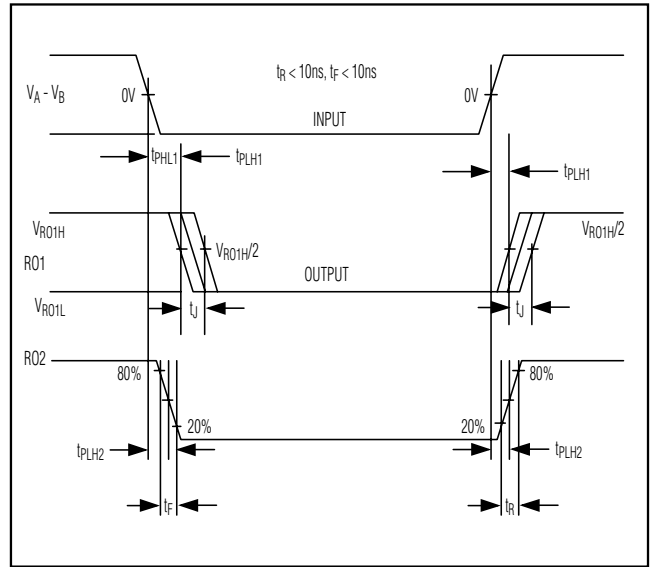

Figure 8. Receiver Propagation Delays

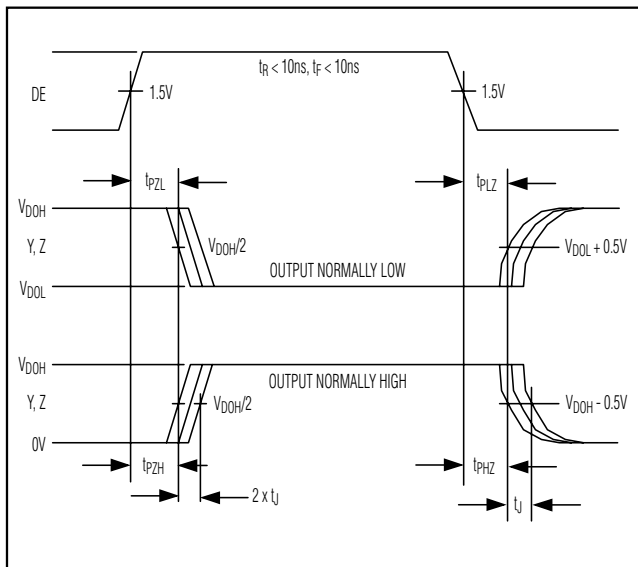

Figure 7. Driver Enable and Disable Times

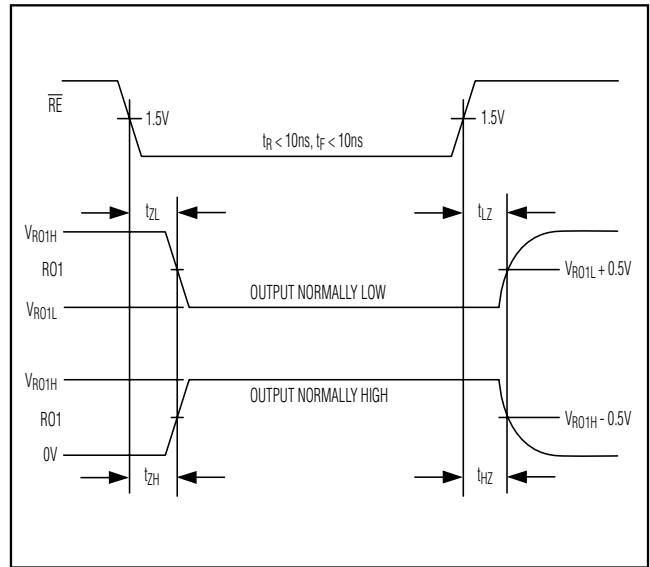

Figure 9. Receiver Enable and Disable Times

# MAX3535E/MXL1535E

## +3V to +5V, 2500V<sub>RMS</sub> Isolated RS-485/RS-422 Transceivers with ±15kV ESD Protection

### **Detailed Description**

The MAX3535E/MXL1535E isolated RS-485/RS-422 full-duplex transceivers provide 2500V<sub>RMS</sub> of galvanic isolation between the RS-485/RS-422 isolation side and the processor or logic side. These devices allow fast, 1000kbps communication across an isolation barrier even when the common-mode voltages (i.e., the ground potentials) on either side of the barrier are subject to large differences. The isolation barrier consists of two parts. The first part is a capacitive isolation barrier (integrated high-voltage capacitors) that allows data transmission between the logic side and the RS-485/RS-422 isolation side. Data is sampled and encoded before it is transmitted across the isolation barrier introducing sampling jitter and further delay into the communication system.

The second part of the isolation barrier consists of an external transformer with the required primary-to-secondary isolation, allowing the transmission of operating power from the logic side across the isolation barrier to the isolation side. Connect the primary of the external transformer to the MAX3535E/MXL1535E's 420kHz transformer driver outputs ST1 and ST2. Since the MXL1535E and the MAX3535E operate with different supply-voltage requirements at their respective isolated and logic sides, different isolation transformers must be used with each device (see the *Transformer Selection* section). The only external components needed to complete the system are the isolation transformer, two diodes, and two low-voltage, 10μF decoupling capacitors (see the *Typical Application Circuit*).

The MAX3535E/MXL1535E include one differential driver, one receiver, and internal circuitry to send the RS-485 signals and logic signals across the isolation barrier (including the isolation capacitors). The MAX3535E/MXL1535E receivers are 1/8 unit load, allowing up to 256 devices on a single bus.

The MAX3535E/MXL1535E feature fail-safe circuitry ensuring the receiver output maintains a logic-high state when the receiver inputs are open or shorted, or when connected to a terminated transmission line with all drivers disabled (see the *Fail Safe* section).

The MAX3535E/MXL1535E feature driver slew-rate select that minimizes electromagnetic interference (EMI) and reduces reflections caused by improperly terminated cables at data rates below 400kbps. The

driver outputs are short-circuit protected for sourcing or sinking current and have overvoltage protection. Other features include hot-swap capability, which holds the driver off if the driver logic signals are floated after power is applied. The MAX3535E/MXL1535E have error-detection circuitry that alerts the processor when there is a fault and disables the driver until the fault is removed.

### **Fail Safe**

The MAX3535E/MXL1535E guarantee a logic-high receiver output when the receiver inputs are shorted or open, or when connected to a terminated transmission line with all drivers disabled. The receiver threshold is fixed between -10mV and -200mV. If the differential receiver input voltage (A - B) is greater than or equal to -10mV, RO1 is logic-high (Table 2). In the case of a terminated bus with all transmitters disabled, the receiver's differential input voltage is pulled to zero by the termination. Due to the receiver thresholds of the MAX3535E/MXL1535E, this results in a logic-high at RO1 with a 10mV minimum noise margin.

### **Driver Output Protection**

Two mechanisms prevent excessive output current and power dissipation caused by faults or by bus contention. The first, a foldback current limit on the output stage, provides immediate protection against short circuits over the entire common-mode voltage range. The second, a thermal-shutdown circuit, forces the driver outputs into a high-impedance state if the die temperature exceeds +150°C.

### **Monitoring Faults on $\overline{RE}$**

$\overline{RE}$  functions as both an input and an output. As an input,  $\overline{RE}$  controls the receiver output enable (RO1). As an output,  $\overline{RE}$  is used to indicate when there are faults associated with the operation of the part. This dual functionality is made possible by using an output driver stage that can easily be overdriven by most logic gates. When an external gate is not actively driving  $\overline{RE}$ , it is driven either high using a 100μA internal pullup current (fault present), or low using a 60μA internal pull-down current (no fault). When using  $\overline{RE}$  to control the receiver-enable output function, be sure to drive it using a gate that has enough sink and source capability to overcome the internal drive.

# MAX3535E/MXL1535E

## +3V to +5V, 2500VRMS Isolated RS-485/RS-422 Transceivers with $\pm 15\text{kV}$ ESD Protection

When not actively driving  $\overline{\text{RE}}$ , it functions as the fault indicator (Table 3). A low on  $\overline{\text{RE}}$  indicates the part is functioning properly, while a high indicates a fault is present. The four causes of a fault indication are:

- 1) The voltage on  $V_{\text{CC1}}$  is below its undervoltage-lock-out threshold (2.69V nominal)
- 2) The voltage on  $V_{\text{CC2}}$  is below its undervoltage-lock-out threshold (2.80V nominal)
- 3) There is a problem that prevents the MAX3535E/MXL1535E from communicating across its isolation barrier
- 4) The die temperature exceeds  $+150^{\circ}\text{C}$  nominally, causing the part to go into thermal shutdown

When a fault occurs, RO1 is switched to a logic-high state if  $\overline{\text{RE}}$  is low (Table 3). Open-circuit or short-circuit conditions on the receiver inputs do not generate fault conditions; however, any such condition also puts RO1 in a logic-high state (see the *Fail Safe* section).

Read  $\overline{\text{RE}}$  for fault conditions by using a bidirectional microcontroller I/O line or a tri-stated buffer as shown in Figure 10. When using a tri-stated buffer, enable the driver whenever the voltage on  $\overline{\text{RE}}$  needs to be forced to a logic-high or logic-low. To read  $\overline{\text{RE}}$  for a fault condition, disable the driver.

### Slew-Rate Control Logic

The  $\overline{\text{SLO}}$  input selects between a fast and a slow slew rate for the driver outputs. Connecting  $\overline{\text{SLO}}$  to GND2 selects the slow slew-rate option that minimizes EMI and reduces reflections caused by improperly terminated cables at data rates up to 400kbps. This occurs because lowering the slew rate decreases the rise and fall times for the signal at the driver outputs, drastically reducing the high-frequency components and harmonics at the output. Floating  $\overline{\text{SLO}}$  or connecting it to  $V_{\text{CC2}}$  selects the fast slew rate, which allows high-speed operation.

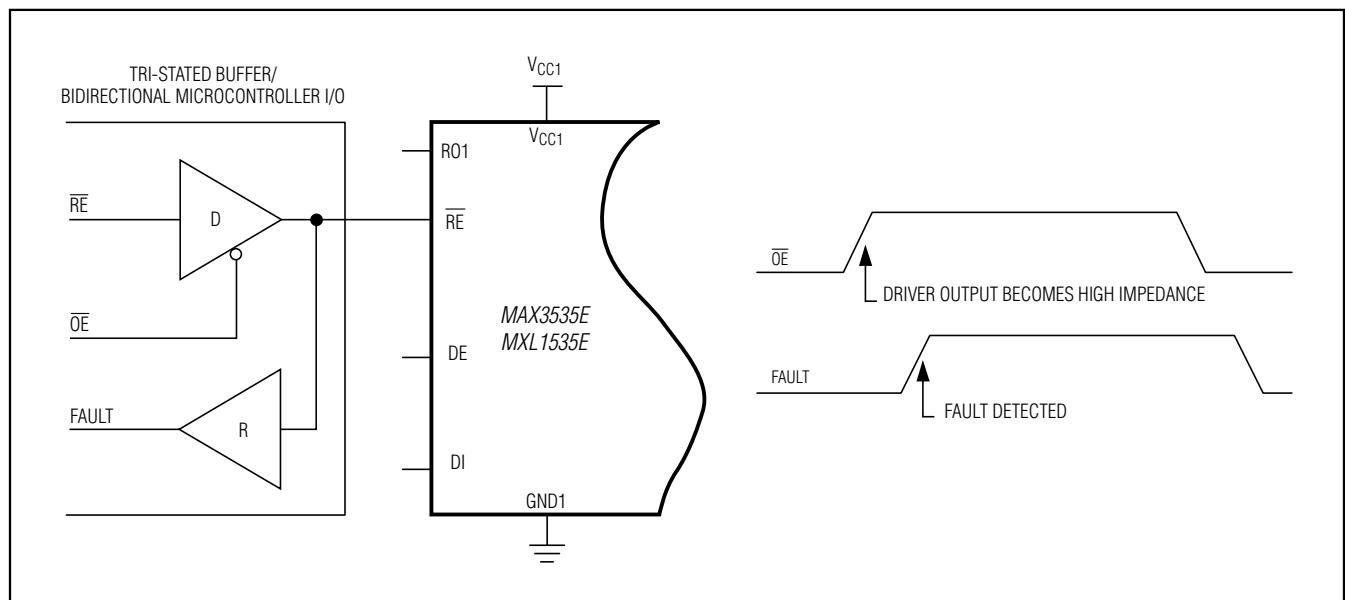

Figure 10. Reading a Fault Condition

# MAX3535E/MXL1535E

## +3V to +5V, 2500V<sub>RMS</sub> Isolated RS-485/RS-422 Transceivers with ±15kV ESD Protection

### Functional Tables

Table 1. Transmitting Logic

TRANSMITTING LOGIC			
INPUTS		OUTPUTS	
DE	DI	Y	Z
1	1	1	0
1	0	0	1
0	X	High impedance	High impedance

Table 2. Receiving Logic

RECEIVING LOGIC			
INPUTS		OUTPUTS	
$\overline{RE}$	V <sub>A</sub> - V <sub>B</sub>	RO1	RO2
0	>-10mV	1	1
0	<-200mV	0	0
0	Inputs open/shorted	1	1
1	>-10mV	High impedance	1
1	<-200mV	High impedance	0
1	Inputs open/shorted	High impedance	1

Table 3. Fault Mode

FUNCTION	NORMAL MODE	FAULT MODES					
	V <sub>CC1</sub> > V <sub>UVH1</sub> V <sub>CC2</sub> > V <sub>UVH2</sub>	V <sub>CC1</sub> < V <sub>UVL1</sub> V <sub>CC2</sub> > V <sub>UVH2</sub>	V <sub>CC1</sub> > V <sub>UVH1</sub> V <sub>CC2</sub> < V <sub>UVL2</sub>	V <sub>CC1</sub> < V <sub>UVL1</sub> V <sub>CC2</sub> < V <sub>UVL2</sub>	THERMAL SHUTDOWN	INTERNAL COMMUNICATION FAULT	
Transformer driver (ST1, ST2)	On	On	On	On	Off	On	
RO1	$\overline{RE} = 0$	Active	High	High	High	High	High
	$\overline{RE} = V_{CC1}$	High impedance	High impedance	High impedance	High impedance	High impedance	High impedance
	$\overline{RE} = \text{floating}$	Active	High impedance	High impedance	High impedance	High impedance	High impedance
RO2	Active	Active	Active	Active	Active	Active	
Driver outputs (Y, Z)	Active	High impedance	High impedance	High impedance	High impedance	High impedance	
Internal barrier communication	Active	Disabled	Disabled	Disabled	Disabled	Communication attempted	
Fault indicator on $\overline{RE}$	Low (60μA pull-down)	High (100μA pullup)	High (100μA pullup)	High (100μA pullup)	High (100μA pullup)	High (100μA pullup)	



# MAX3535E/MXL1535E

## +3V to +5V, 2500VRMS Isolated RS-485/RS-422 Transceivers with ±15kV ESD Protection

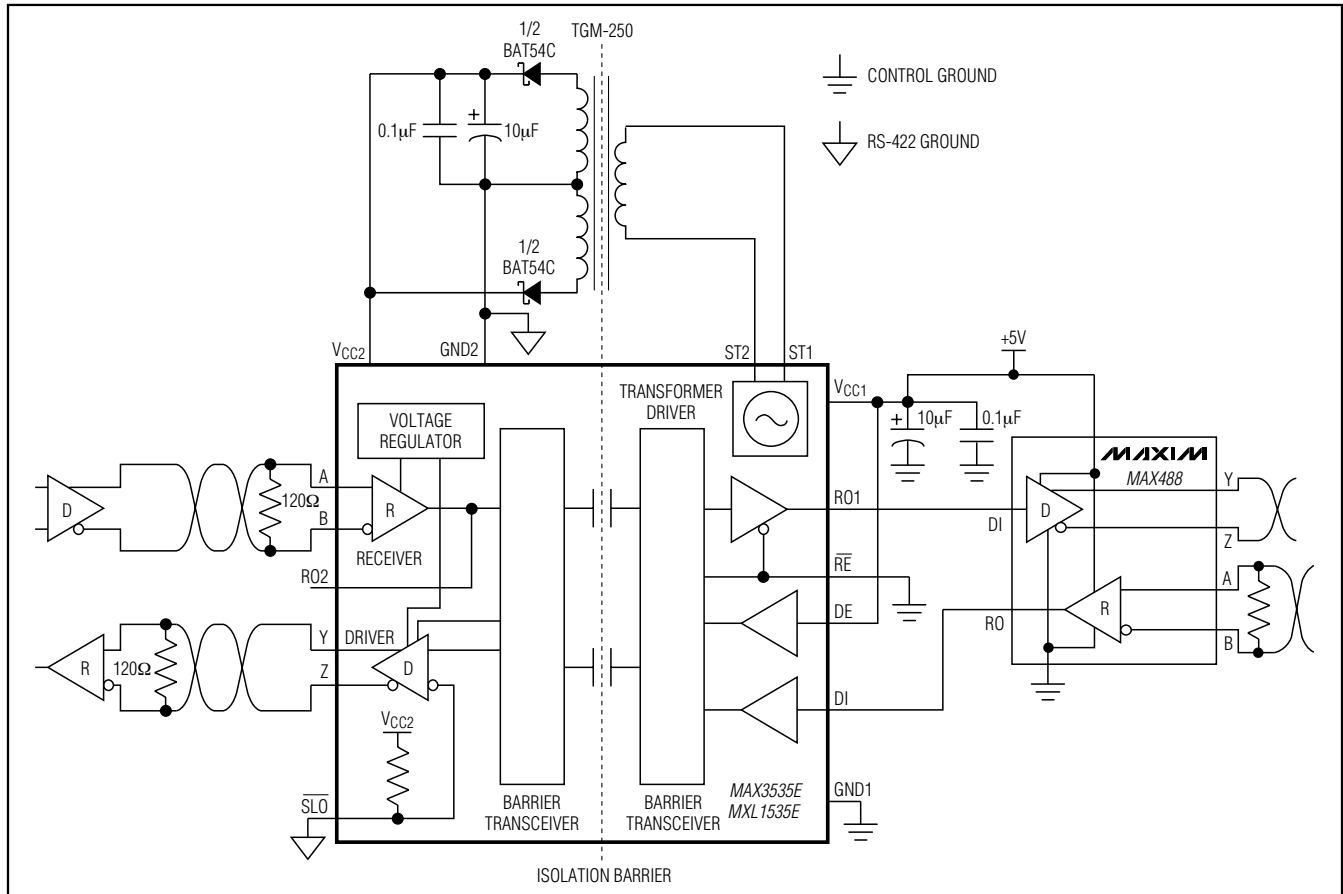

Figure 12. Using the MAX3535E/MXL1535E as an RS-422 Line Repeater

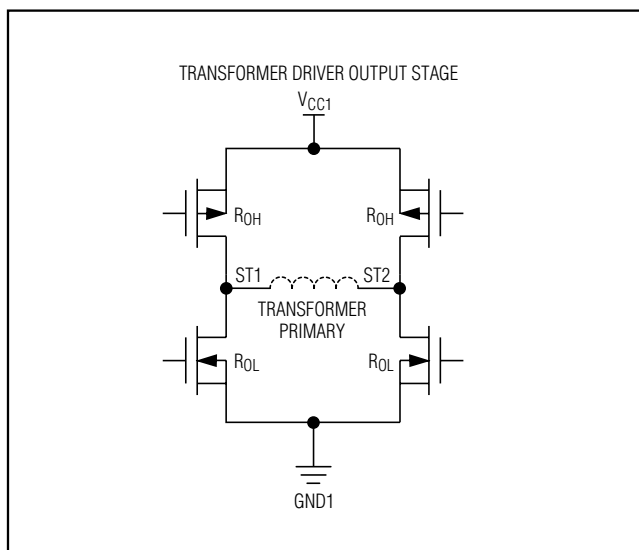

Figure 13. Transformer Driver Output Stage

### Transformer Selection

The MXL1535E is a pin-for-pin compatible upgrade of the LTC1535, making any transformer designed for that device suitable for the MXL1535E (see Table 4). These transformers all have a turns ratio of about 1:1.3CT.

The MAX3535E can operate with any of the transformers listed in Table 4, in addition to smaller, thinner transformers designed for the MAX845 and MAX253. The 420kHz transformer driver operates with single primary and center-tapped secondary transformers. When selecting a transformer, do not exceed its ET product, the product of the maximum primary voltage and half the highest period of oscillation (lowest oscillating frequency). This ensures that the transformer does not enter saturation. Calculate the minimum ET product for the transformer primary as:

$$ET = V_{MAX} / (2 \times f_{MIN})$$

where,  $V_{MAX}$  is the worst-case maximum supply voltage, and  $f_{MIN}$  is the minimum frequency at that supply voltage. Using +5.5V and 290kHz gives a required minimum ET

# MAX3535E/MXL1535E

## +3V to +5V, 2500VRMS Isolated RS-485/RS-422 Transceivers with ±15kV ESD Protection

product of 9.5V-μs. The commercially available transformers for the MAX845 listed in Table 5 meet that requirement. In most cases, use half of the center-tapped primary winding with the MAX3535E and leave the other end of the primary floating. Most of the transformers in Table 5 are 1:1:1 or 1:1:1:1 turns ratio.

For +3.3V operation (+3.6V maximum) the required primary ET product is 6.2V-μs. All of the previously mentioned transformers meet this requirement. Table 6 lists some other transformers with step-up turns ratios specifically tailored for +3.3V operation. Most of the transformers in Table 6 are 1:1:1.3:1.3.

By using a HALO TGM-010 or Midcom 95061 transformer, it becomes possible to build a complete isolated RS-485/RS-422 transceiver with a maximum thickness

less than 0.1in. To minimize power consumption, select the turns ratio of the transformer to produce the minimum DC voltage required at V<sub>CC2</sub> (+3.13V) under worst-case, high-temperature, low-V<sub>CC1</sub>, and full-load conditions. For light loads on the isolated side, ensure that the voltage at V<sub>CC2</sub> does not exceed +7.5V. For example, the CTX01-14659 transformer results in 85mA (typ) V<sub>CC1</sub> supply current with full load on the RS-485 driver. Using a TGM250 1:1:1 transformer lowers the V<sub>CC1</sub> supply current to 65mA (typ), while maintaining good margin on the V<sub>CC2</sub> supply. A slight step-down transformer can result in extra power savings in some situations. A custom wound sample transformer with 23 primary turns and 20:20 secondary turns on a Ferronics 11-050B core operates well with a V<sub>CC1</sub> supply current of 51mA (typ).

**Table 4. Transformers for the MXL1535E/MAX3535E**

MANUFACTURER	PART NUMBER	ISOLATION VOLTAGE (1s)	PHONE NUMBER
Cooper Electronic Technologies, Inc.	CTX01-14659	500V	561-241-7876
Cooper Electronic Technologies, Inc.	CTX01-14608	3750V <sub>RMS</sub>	561-241-7876
EPCOS AG (Germany) (USA)	B78304-A1477-A3	500V	0 89-626-2-80-00 800-888-7724
Midcom, Inc.	31160R	1250V	605-886-4385
Pulse FEE (France)	P1597	500V	33-3-85-35-04-04
Sumida Corporation (Japan)	S-167-5779	100V	03-3667-3320
Transpower Technologies, Inc.	TTI7780-SM	500V	775-852-0145

**Table 5. Transformers for MAX3535E at +5V**

MANUFACTURER	PART NUMBER	ISOLATION VOLTAGE (1s)	PHONE NUMBER	WEBSITE
HALO Electronics, Inc.	TGM-010	500V <sub>RMS</sub>	650-903-3800	www.haloelectronics.com/6pin.html
	TGM-250	2000V <sub>RMS</sub>		
	TGM-350	3000V <sub>RMS</sub>		
	TGM-450	4500V <sub>RMS</sub>		
BH Electronics, Inc.	500-1749	3750V <sub>RMS</sub>	952-894-9590	www.bhelectronics.com/PDFs/DC-DCCConverterTransformers.pdf
Coilcraft, Inc.	U6982-C	1500V <sub>RMS</sub>	800-322-2645 44-1236-730595	www.coilcraft.com/minitrans.cfm
Newport/C&D Technologies	7825355	1500V	520-295-4300	www.dc-dc.com/products/productline.asp?ED=9
	7625335	4000V		
Midcom, Inc.	95061	1250V	605-886-4385	www.midcom-inc.com
PCA Electronics, Inc.	EPC3115S-5	700V DC	818-894-5791	www.pca.com/Datasheets/EPC3117S-X.pdf
Rhombus Industries, Inc.	T-1110	1800V <sub>RMS</sub>	714-898-0960	www.rhombus-ind.com/pt-cat/maxim.pdf
Premier Magnetics, Inc.	PM-SM15	1500V <sub>RMS</sub>	949-452-0511	www.premiermag.com/pdf/pmsm15.pdf

# MAX3535E/MXL1535E

## +3V to +5V, 2500VRMS Isolated RS-485/RS-422 Transceivers with ±15kV ESD Protection

Table 6. Transformers for MAX3535E at +3.3V

MANUFACTURER	PART NUMBER	ISOLATION VOLTAGE (1s)	PHONE NUMBER	WEBSITE
HALO Electronics, Inc.	TGM-040	500VRMS	650-903-3800	www.haloelectronics.com/6pin.html
	TGM-240	2000VRMS		
	TGM-340	3000VRMS		
	TGM-340	4500VRMS		
BH Electronics, Inc.	500-2582	2000VRMS	952-894-9590	www.bhelectronics.com/PDFs/DC-DCCConverterTransformers.pdf
Coilcraft, Inc.	Q4470-C	1500VRMS	800-322-2645 44-1236-730595	www.coilcraft.com/minitrans.cfm
Newport/C&D Technologies	78253335	1500V	520-295-4300	www.dc-dc.com/products/productline.asp?ED=9
	76253335	4000V		
Midcom, Inc.	95062	1250V	605-886-4385	www.midcom-inc.com
	95063	1250V		
PCA Electronics, Inc.	EPC3115S-2	700V DC	818-894-5791	www.pca.com/Datasheets/EPC3117S-X.pdf
Rhombus Industries, Inc.	T-1107	1800VRMS	714-898-0960	www.rhombus-ind.com/pt-cat/maxim.pdf
Premier Magnetics Inc.	PM-SM16	1500VRMS	949-452-0511	www.premiermag.com/pdf/pmsm15.pdf

### ±15kV ESD Protection

As with all Maxim devices, ESD-protection structures are incorporated on all pins to protect against electrostatic discharges encountered during handling and assembly. The driver outputs and receiver inputs have extra protection against static electricity. Maxim's engineers have developed state-of-the-art structures to protect these pins against ESD of ±15kV without damage. The ESD structures withstand high ESD in all states. After an ESD event, the MAX3535E/MXL1535E keep working without latchup. ESD protection can be tested in various ways. The transmitter outputs and receiver inputs of this product family are characterized for protection to ±15kV using the Human Body Model.

### ESD Test Conditions

The ±15kV ESD test specifications apply only to the A, B, Y, and Z I/O pins. The test surge is referenced to GND2. All remaining pins are ±2kV ESD protected.

### Human Body Model

Figure 14 shows the Human Body Model, and Figure 15 shows the current waveform it generates when dis-

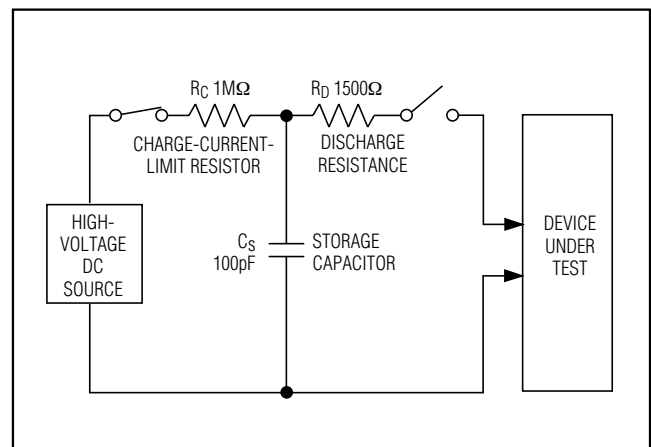

Figure 14. Human Body ESD Test Model

charged into low impedance. This model consists of a 100pF capacitor charged to the ESD voltage of interest, which is then discharged into the test device through a 1.5kΩ resistor.

# MAX3535E/MXL1535E

## +3V to +5V, 2500VRMS Isolated RS-485/RS-422 Transceivers with $\pm 15\text{kV}$ ESD Protection

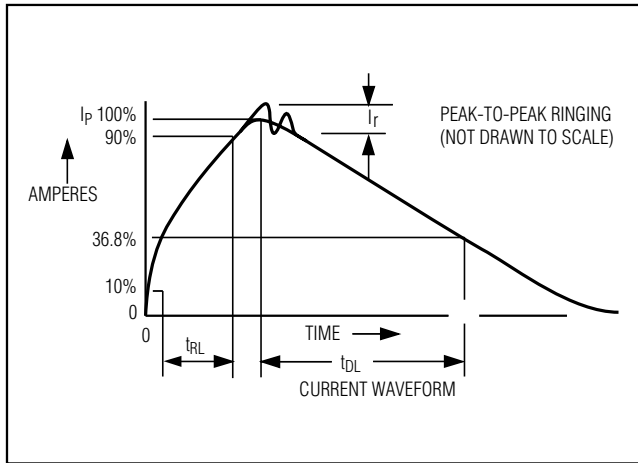

Figure 15. Human Body Current Waveform

### Machine Model

The Machine Model for ESD tests all pins using a 200pF storage capacitor and zero discharge resistance. Its objective is to simulate the stress caused by contact that occurs with handling and assembly during manufacturing. All pins require this protection during manufacturing, not just inputs and outputs. Therefore, after PC board assembly, the Machine Model is less relevant to I/O ports.

### Skew

The self-oscillation circuit shown in Figure 5 is an excellent way to get an approximate measure of the speed of the MAX3535E/MXL1535E. An oscillation frequency of 250kHz in this configuration implies a data rate of at least 500kbps for the receiver and transmitter combined. In practice, data can usually be sent and received at a considerably higher data rate, normally limited by the allowable jitter and data skew. If the system can tolerate a 25% data skew, (the difference between  $t_{PLH1}$  and  $t_{PHL1}$ ), the 285ns maximum jitter specification implies a data rate of 877kbps. Lower data rates result in less distortion and jitter (Figure 16).

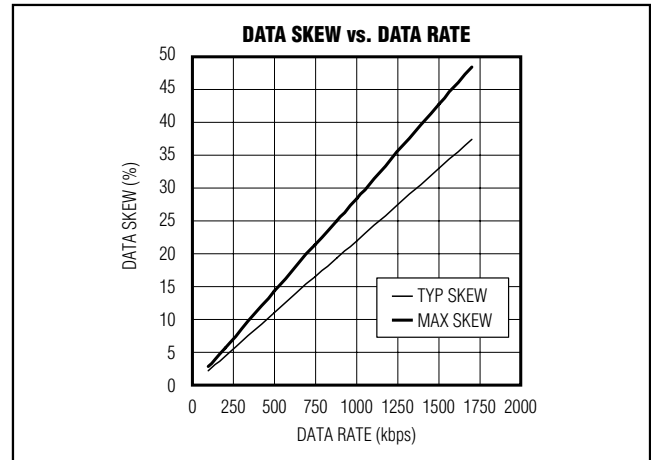

Figure 16. Data Skew vs. Data Rate Graph

Higher rates are possible but with more distortion and jitter. The data rate should always be limited below 1.75Mbps for both receiver and driver to avoid interference with the internal barrier communication.

### Layout Considerations

The MAX3535E/MXL1535E pin configurations enable optimal PC board layout by minimizing interconnection lengths and crossovers:

- For maximum isolation, the isolation barrier should not be breached except by the MAX3535E/MXL1535E and the transformer. Connections and components from one side of the barrier should not be located near those of the other side of barrier.
- A shield trace connected to the ground on each side of the barrier can help intercept capacitive currents that might otherwise couple into the DI and  $\overline{\text{SLO}}$  inputs. In a double-sided or multilayer board, these shield traces should be present on all conductor layers.
- Try to maximize the width of the isolation barrier wherever possible. A clear space of at least 0.25in between GND1 and GND2 is recommended.



# MAX3535E/MXL1535E

## +3V to +5V, 2500VRMS Isolated RS-485/RS-422 Transceivers with ±15kV ESD Protection

### Package Information

(The package drawing(s) in this data sheet may not reflect the most current specifications. For the latest package outline information go to [www.maxim-ic.com/packages](http://www.maxim-ic.com/packages).)

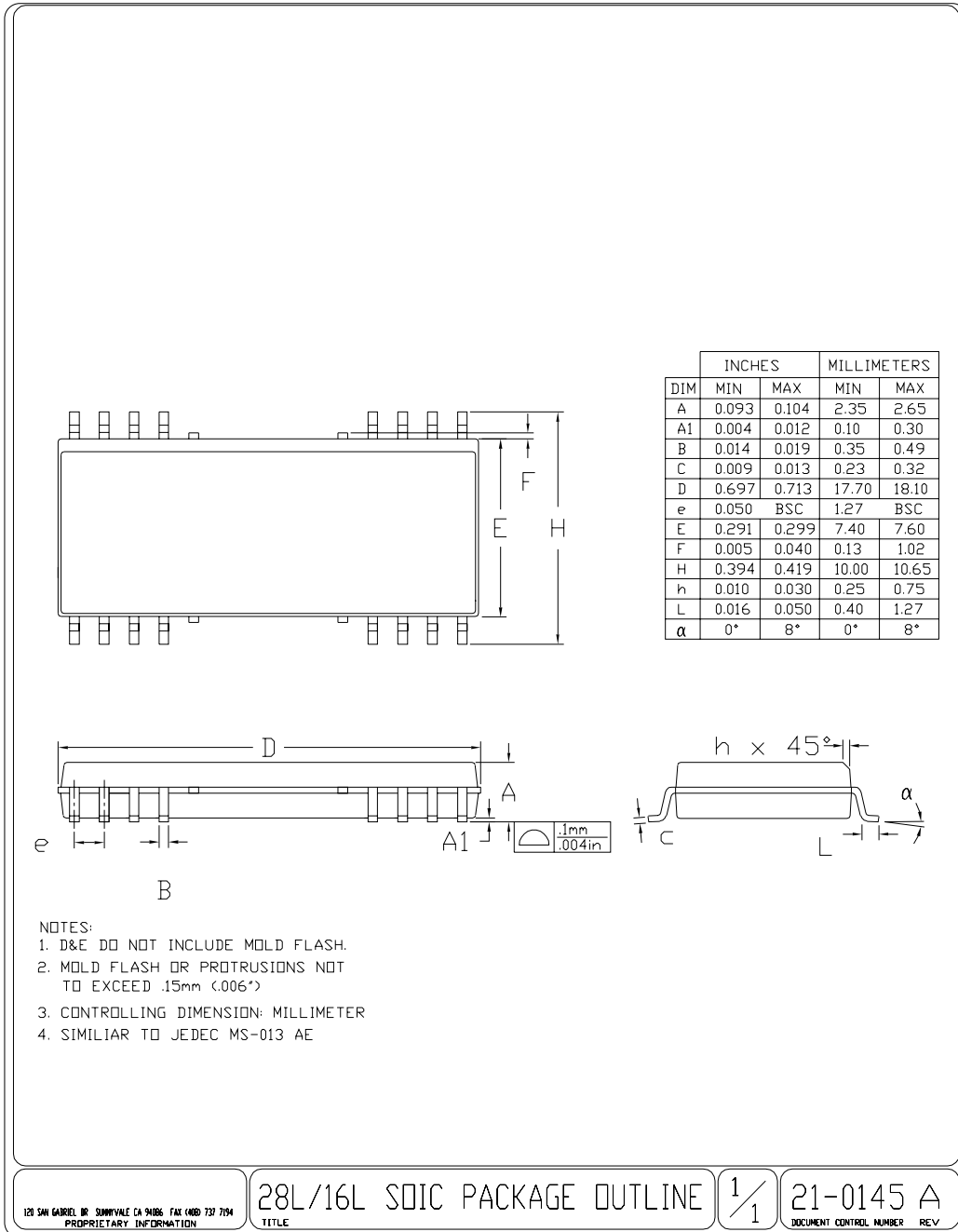

# **MAX3535E/MXL1535E**

**+3V to +5V, 2500VRMS Isolated RS-485/RS-422  
Transceivers with  $\pm 15\text{kV}$  ESD Protection**



*Maxim cannot assume responsibility for use of any circuitry other than circuitry entirely embodied in a Maxim product. No circuit patent licenses are implied. Maxim reserves the right to change the circuitry and specifications without notice at any time. The parametric values (min and max limits) shown in the Electrical Characteristics table are guaranteed. Other parametric values quoted in this data sheet are provided for guidance.*

## Looking for pricing, stock, or lifecycle information?

Click below to explore more details on WIN SOURCE:

- ⊖ [View MXL1535ECWI+T on WIN SOURCE](#)
- ⊖ [Maxim Integrated Information](#)

## Optimize Your Supply Chain with WIN SOURCE Solutions

- ✓ Global Sourcing Solution
- ✓ Obsolete Management
- ✓ Cost Control Management
- ✓ Shortage Management
- ✓ Alternative Solution
- ✓ Excess Inventory Management