



**THE DATASHEET OF  
MLX90254LVA-BBA-000-BU**



### Features and Benefits

- Differential Hall sensor
- Low consumption
- Excellent repeatability performance
- Large airgap range
- Large supply voltage range
- Distance between Hall plates : 2.25 mm

### Applications

- Crankshaft sensor
- Speed sensor

### Ordering Code

Product Code	Temperature Code	Package Code	Option Code	Packing Form Code
MLX90254	L	VA	BBA-000	BU

#### Legend:

Temperature Code:	L for Temperature Range -40 °C to 150 °C
Package Code:	VA for Plastic single in line
Packing Form:	BU for Bulk

Ordering example: MLX90254LVA-BBA-000-BU

### 1. Functional Diagram

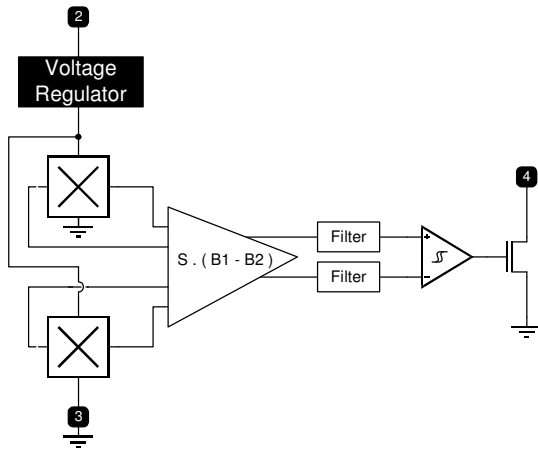

Pin 1 – Not used  
 Pin 2 – Vdd (Supply)  
 Pin 3 – Vss (Ground)  
 Pin 4 - Output

### 2. Description

The MLX90254 is a Differential Dynamic Hall Effect Sensor which has been developed for automotive crankshaft and ABS (anti-lock brake system) applications. The IC, combined with a magnet placed at his back, offers speed and position sensing of ferromagnetic tooth-wheels in dynamic operation (non zero speed). Its low hysteresis enables it to operate over a wide range of air gaps from -40°C to 150°C.

The use of two Hall cells makes the operation sensitive to a rotation of the IC around its normal axis.

The output structure is an Open-Drain NMOS transistor with a capability of 25 mA under 24V and protected against short-circuits. The IC is packaged in 4-SIP VA.

## ***Table of CONTENTS***

<b>FEATURES AND BENEFITS .....</b>	<b>1</b>
<b>APPLICATIONS.....</b>	<b>1</b>
<b>1. FUNCTIONAL DIAGRAM.....</b>	<b>2</b>
<b>2. DESCRIPTION.....</b>	<b>2</b>
<b>3. GLOSSARY OF TERMS .....</b>	<b>4</b>
<b>4. ABSOLUTE MAXIMUM RATINGS .....</b>	<b>4</b>
<b>5. MLX90254 ELECTRICAL SPECIFICATIONS .....</b>	<b>5</b>
<b>6. MLX90254 SENSOR SPECIFIC SPECIFICATIONS .....</b>	<b>6</b>
<b>7. GENERAL DESCRIPTION .....</b>	<b>6</b>
<b>8. PERFORMANCE GRAPHS.....</b>	<b>7</b>
<b>9. STANDARD INFORMATION REGARDING MANUFACTURABILITY OF MELEXIS PRODUCTS WITH DIFFERENT SOLDERING PROCESSES .....</b>	<b>8</b>
<b>10. ESD PRECAUTIONS.....</b>	<b>8</b>
<b>11. PACKAGE INFORMATION.....</b>	<b>9</b>
<b>12. DISCLAIMER.....</b>	<b>10</b>

### 3. Glossary of Terms

1 mT = 10 Gauss: Flux density units.

Pre-induction: the pre-induction is the magnetic field induced by the back bias magnet.

Operating point: the value of the differential flux density when the transistor output turns ON.

Release point: the value of the differential flux density when the transistor output turns OFF

Margin: the flux density of the magnetic field has to be higher or lower than the margin value to enable the next toggling of the output.

### 4. Absolute Maximum Ratings

Supply Voltage, $V_{DD}$	24 V
Reverse Voltage Protection	-0.3 V
Output Current, $I_{OUT}$	25 mA
Output Short-Circuit Current	150 mA
Output Voltage	24 V
Operating Temperature Range, $T_A$	-40 °C to 150°C
Storage Temperature Range, $T_S$	-55 °C to 165°C
Maximum Junction Temperature	175 °C
Magnetic Flux Density	Infinite

Exceeding the absolute maximum ratings may cause permanent damage. Exposure to absolute-maximum-rated conditions for extended periods may affect device reliability.

### 5. MLX90254 Electrical Specifications

DC Operating Parameters  $T_A = -40^{\circ}\text{C}$  to  $150^{\circ}\text{C}$ ,  $V_{DD} = 4\text{V}$  to  $24\text{V}$  (unless otherwise specified)

Parameter	Symbol	Test Conditions	Min	Typ	Max	Units
Supply Voltage	Vs		4	12	24	V
Supply Current (1)	Is		5	8.5	12	mA
Output Voltage	Vout	Output state: OFF			24	V
Output DC Current	Iout	Vout < 1V			25	mA
Output Saturation Voltage	Vsat	Output state: ON Iout=25 mA			500	mV
Output Short-Circuit Current	Iscprot	Output state: ON Vout > 2V	10	45	70	mA
Output Leakage Current	Ileak	Output state: OFF			10	$\mu\text{A}$
Output Rise Time	Tr	Vout = 12 V Rpull-up = 600 $\Omega$ No Load Capacitor			0.1	$\mu\text{s}$
Output Fall Time	Tf	Vout = 4.5 .. 24 V Cload = 1 nF Rpull-up = 1 k $\Omega$			0.5	$\mu\text{s}$
Startup Time (2)	Tpower-on				150	ms
Frequency (3)	f		15		30000	Hz
Supply Rise Time	Tsr	Vs = 0 .. 24 V	100			ns

(1) Supply current can rise-up to 20 mA max. in the 3-4 volts Vdd range.

(2) Start-up time: when the wheel has started spinning, the output signal appears after a few teeth but a delay up to 150 ms could be seen before the highest accuracy/repeatability.

(3) The frequency is linked with the first order high pass filter with a cut-off frequency smaller than 20 Hz.

### 6. MLX90254 Sensor Specific Specifications

DC Operating Parameters  $T_A = -40^{\circ}\text{C}$  to  $150^{\circ}\text{C}$ ,  $V_{DD} = 4\text{V}$  to  $24\text{V}$  (unless otherwise specified)

Parameter	Symbol	Test Conditions	Min	Typ	Max	Units
Preinduction	B <sub>DC</sub>		-500		500	mT
Differential Induction(4)	$\Delta B_{AC}$		6		100	mT
Operating Point	B <sub>op</sub>		-0.5	0	0.5	mT
Release Point	B <sub>rp</sub>		-0.5	0	0.5	mT
Positive margin	M +		0.5	2	3	mT
Negative margin	M -		-3	-2	-0.5	mT
Magnetic Hysteresis	B <sub>hyst</sub>			0		mT

(4) The differential field must exceed 6 mT to assure the switching of the output

### 7. General Description

Let us model the magnetic flux densities by sinusoids. If the wheel confirms a certain geometrical property, the two Hall cells see two magnetic flux densities in phase opposition. They are illustrated by the dashed sinusoid on figure 1.

The difference between the two Hall signals is computed and amplified. The remaining DC offset is removed by the high-pass filter. The noise that is out of the signal bandwidth is attenuated by the low-pass filter in order to minimize the output jitter.

The AC differential signal is compared to the B<sub>op</sub> and B<sub>rp</sub> threshold and the result of that comparison commands the open drain output transistor.

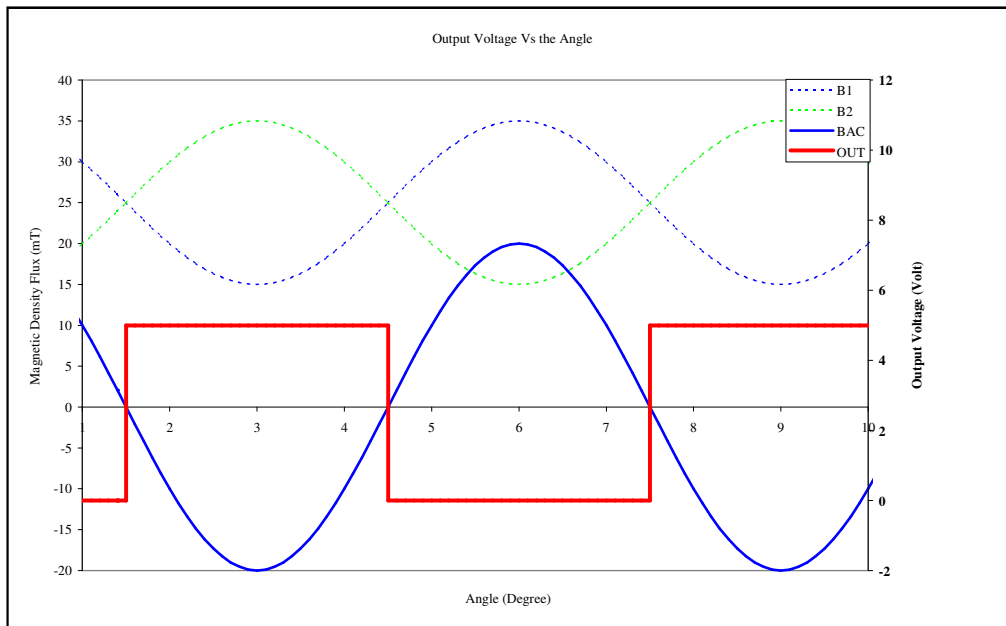
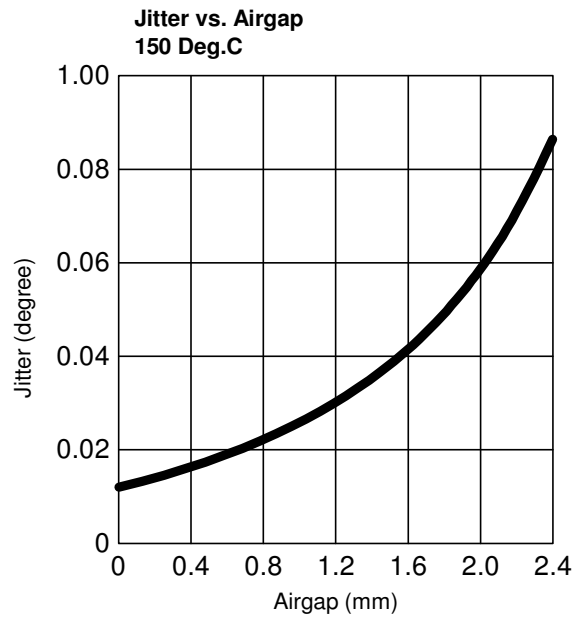
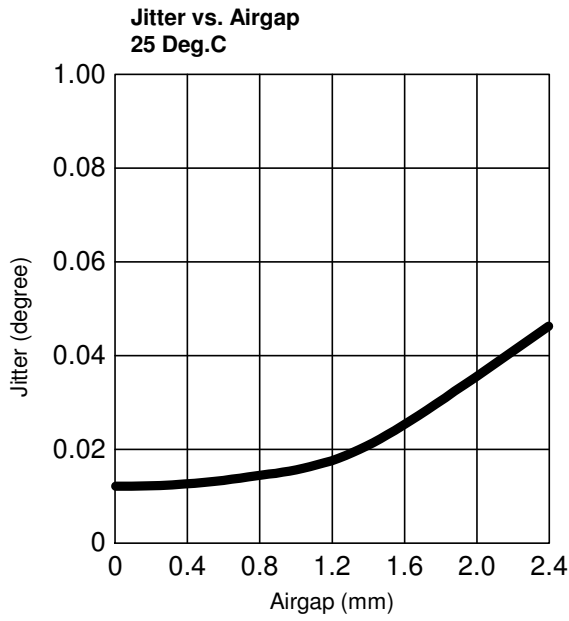

Figure 1: Output toggling according to the differential magnetic signal.

**8. Performance Graphs**



### **9. Standard information regarding manufacturability of Melexis products with different soldering processes**

Our products are classified and qualified regarding soldering technology, solderability and moisture sensitivity level according to following test methods:

#### **Reflow Soldering SMD's (Surface Mount Devices)**

- IPC/JEDEC J-STD-020  
Moisture/Reflow Sensitivity Classification for Nonhermetic Solid State Surface Mount Devices (classification reflow profiles according to table 5-2)
- EIA/JEDEC JESD22-A113  
Preconditioning of Nonhermetic Surface Mount Devices Prior to Reliability Testing (reflow profiles according to table 2)

#### **Wave Soldering SMD's (Surface Mount Devices) and THD's (Through Hole Devices)**

- EN60749-20  
Resistance of plastic- encapsulated SMD's to combined effect of moisture and soldering heat
- EIA/JEDEC JESD22-B106 and EN60749-15  
Resistance to soldering temperature for through-hole mounted devices

#### **Iron Soldering THD's (Through Hole Devices)**

- EN60749-15  
Resistance to soldering temperature for through-hole mounted devices

#### **Solderability SMD's (Surface Mount Devices) and THD's (Through Hole Devices)**

- EIA/JEDEC JESD22-B102 and EN60749-21  
Solderability

For all soldering technologies deviating from above mentioned standard conditions (regarding peak temperature, temperature gradient, temperature profile etc) additional classification and qualification tests have to be agreed upon with Melexis.

The application of Wave Soldering for SMD's is allowed only after consulting Melexis regarding assurance of adhesive strength between device and board.

Melexis is contributing to global environmental conservation by promoting **lead free** solutions. For more information on qualifications of **RoHS** compliant products (RoHS = European directive on the Restriction Of the use of certain Hazardous Substances) please visit the quality page on our website: <http://www.melexis.com/quality.aspx>

### **10. ESD Precautions**

Electronic semiconductor products are sensitive to Electro Static Discharge (ESD). Always observe Electro Static Discharge control procedures whenever handling semiconductor products.

### 11. Package Information

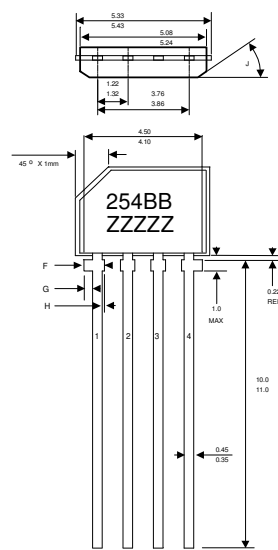

**VA Package Dimensions**

Symbol	Value
A	1.20
B	0.66
C	0.29
D	45°
E	0.31
F	0.80
G	0.40
H	0.15
J	45°

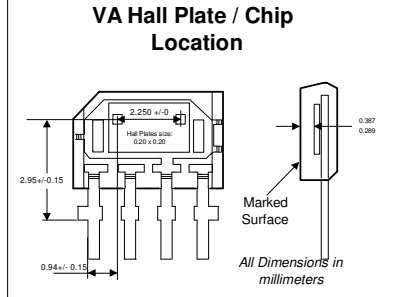

**VA Hall Plate / Chip Location**

2.250 ±0.05  
Hall Plate size: 0.20 x 0.20

2.95 ±0.15  
0.94 ±0.15  
0.367  
0.289

Marked Surface

All Dimensions in millimeters

**Notes:**

- Pinout:
 

Pin 1	Not Used
Pin 2	Vdd
Pin 3	GND
Pin 4	Output
- Controlling dimension: mm .
- Leads must be free of flash and plating voids.
- Leads must not arc toward the rear of package.
- Package dimensions exclude molding flash.
- Tolerance: +/- 0.254 mm unless otherwise specified.
- Marking:
 

Line 1:  
3 first digits (254) =Part Number MLX90254  
2 last digit (BB) = Version

Line 2:  
5 digits (ZZZZZ) =Lot Number

Back Side Marking  
4 digits (YYWW) =Date Code

### 12. Disclaimer

Devices sold by Melexis are covered by the warranty and patent indemnification provisions appearing in its Term of Sale. Melexis makes no warranty, express, statutory, implied, or by description regarding the information set forth herein or regarding the freedom of the described devices from patent infringement. Melexis reserves the right to change specifications and prices at any time and without notice. Therefore, prior to designing this product into a system, it is necessary to check with Melexis for current information. This product is intended for use in normal commercial applications. Applications requiring extended temperature range, unusual environmental requirements, or high reliability applications, such as military, medical life-support or life-sustaining equipment are specifically not recommended without additional processing by Melexis for each application.

The information furnished by Melexis is believed to be correct and accurate. However, Melexis shall not be liable to recipient or any third party for any damages, including but not limited to personal injury, property damage, loss of profits, loss of use, interrupt of business or indirect, special incidental or consequential damages, of any kind, in connection with or arising out of the furnishing, performance or use of the technical data herein. No obligation or liability to recipient or any third party shall arise or flow out of Melexis' rendering of technical or other services.

© 2012 Melexis NV. All rights reserved.

For the latest version of this document, go to our website at  
**[www.melexis.com](http://www.melexis.com)**



Or for additional information contact Melexis Direct:

<b>Europe, Africa, Asia:</b>	<b>America:</b>
Phone: +32 1367 0495	Phone: +1 248 306 5400
E-mail: <a href="mailto:sales_europe@melexis.com">sales_europe@melexis.com</a>	E-mail: <a href="mailto:sales_usa@melexis.com">sales_usa@melexis.com</a>

ISO/TS 16949 and ISO14001 Certified

## Looking for pricing, stock, or lifecycle information?

Click below to explore more details on WIN SOURCE:

-  [View MLX90254LVA-BBA-000-BU on WIN SOURCE](#)
-  [Melexis Technologies NV Information](#)

## Optimize Your Supply Chain with WIN SOURCE Solutions

-  Global Sourcing Solution
-  Obsolete Management
-  Cost Control Management
-  Shortage Management
-  Alternative Solution
-  Excess Inventory Management