

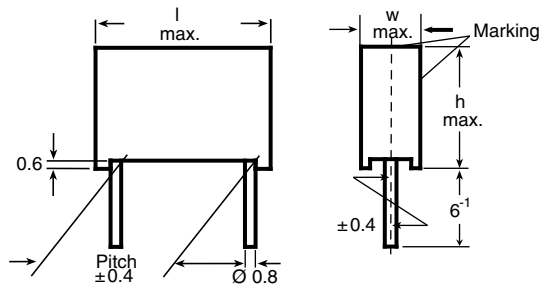

**THE DATASHEET OF  
MKP1840522254M**



## AC and Pulse Metallized Polypropylene Film Capacitors MKP Radial Potted Type



Dimensions in millimeters

LEAD DIAMETER $d_t$ (mm)	W (mm)	PITCH (mm)
$0.5 \pm 0.05$	-	5
$0.6 \pm 0.06$	-	7.5 to 10
$0.8 \pm 0.08$	< 16	15 to 37.5
$1.0 \pm 0.1$	$\geq 16.5$	15 to 37.5

### APPLICATIONS

High frequency and pulse operations. Deflection circuits in TV-sets (S-correction), SMPS, loudspeaker crossover networks, electronic ballast, storage, filter, timing and sample and hold circuits.

### REFERENCE STANDARDS

IEC 60384-16

### MARKING

C-value; tolerance; rated voltage; manufacturer's type; code for dielectric material; manufacturer location; manufacturer's logo; year and week

### DIELECTRIC

Polypropylene film

### ELECTRODES

Metallized

### CONSTRUCTION

Mono and internal series construction

### RATED DC VOLTAGES

250 V, 400 V, 630 V, 1000 V

### RATED AC VOLTAGES

160 V, 220 V, 250 V, 400 V, 500 V

### FEATURES

5 mm to 37.5 mm lead pitch.  
Supplied loose in box, taped on reel and ammpack.  
RoHS compliant

**RoHS**  
COMPLIANT

### ENCAPSULATION

Plastic case, epoxy resin sealed, flame retardant  
UL-class 94 V-0

### CLIMATIC TESTING CLASS ACC. TO EN 60068-1

55/100/56

### CAPACITANCE RANGE

 1000 pF to 6.8  $\mu$ F

### CAPACITANCE TOLERANCE

 $\pm 5\%$ ,  $\pm 2\%$ ,  $\pm 2.5\%$ 

### LEADS

Tinned wire

### MAXIMUM APPLICATION TEMPERATURE

100 °C

### DETAIL SPECIFICATION

For more detailed data and test requirements, contact:  
[dc-film@vishay.com](mailto:dc-film@vishay.com)

## COMPOSITION OF CATALOG NUMBER

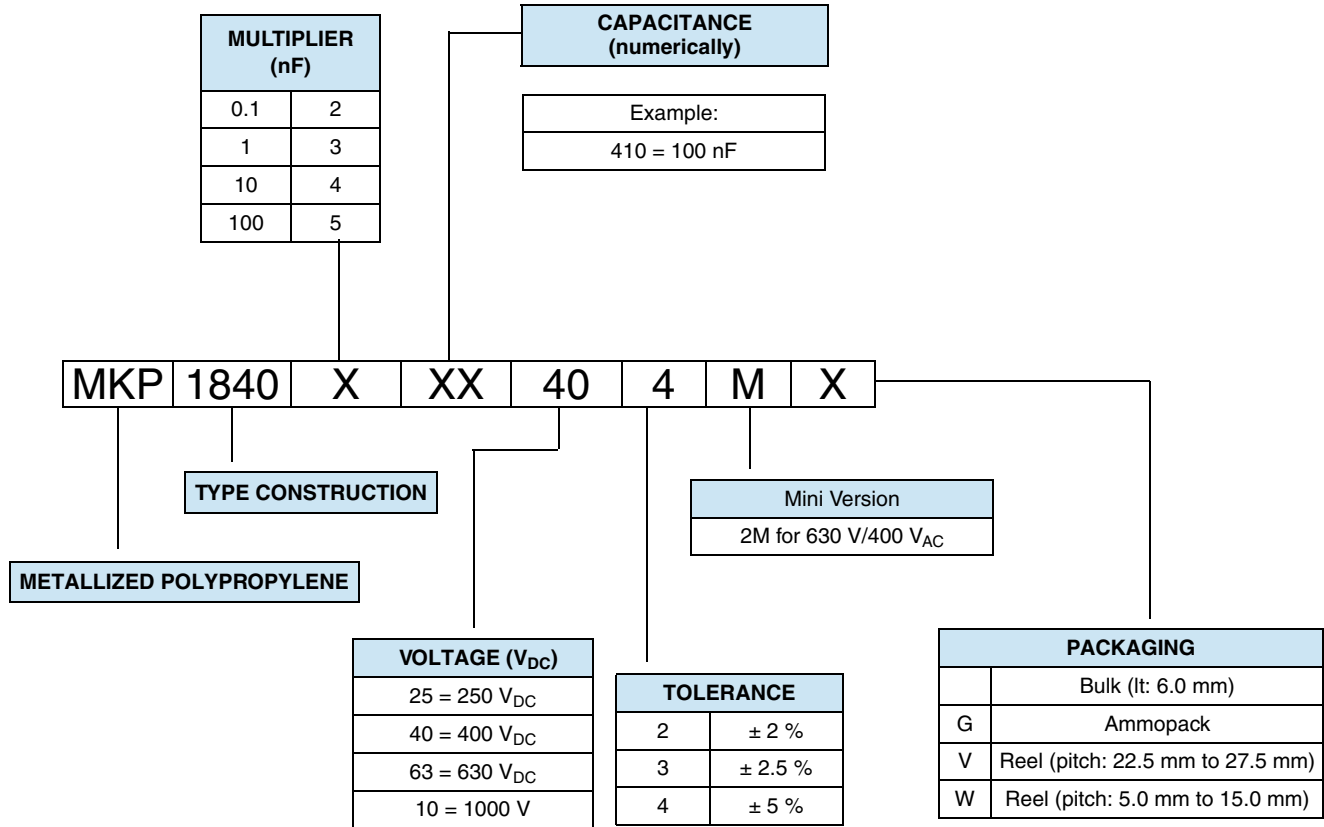

### Note

For detailed tape specifications refer to "Packaging Information" [www.vishay.com/doc?28139](http://www.vishay.com/doc?28139) or end of catalog

## SPECIFIC REFERENCE DATA

DESCRIPTION		VALUE		
Tangent of loss angle:		at 1 kHz	at 10 kHz	at 100 kHz
C ≤ 0.1 μF		4 x 10 <sup>-4</sup>	6 x 10 <sup>-4</sup>	40 x 10 <sup>-4</sup>
0.1 μF < C ≤ 1.0 μF		4 x 10 <sup>-4</sup>	10 x 10 <sup>-4</sup>	-
C > 1.0 μF		10 x 10 <sup>-4</sup>	-	-
Pitch (mm)	Maximum pulse rise time (dU/dt) <sub>R</sub> [V/μs]			
	250 V <sub>DC</sub>	400 V <sub>DC</sub>	630 V <sub>DC</sub>	1000 V <sub>DC</sub>
5	360	540	1080	-
7.5	215	325	510	-
10	150	240	340	1365
15	90	135	185	680
22.5	55	80	110	370
27.5	40	65	85	285
37.5	30	45	60	195
R between leads, for C ≤ 1.0 μF at 100 V, 1 min				> 100 000 MΩ
RC between leads, for C > 1.0 μF at 100 V, 1 min				> 100 000 s
R between leads and case, 100 V, 1 min				> 30 000 MΩ
Withstanding (DC) voltage (cut off current 10 mA) rise time 100 V/s				1.6 x U <sub>Rdc</sub> , 1 min
Withstanding (DC) voltage between leads and case				500 V, 1 min
Maximum application temperature				100 °C



AC and Pulse Metallized Polypropylene Film Capacitors Vishay Roederstein  
MKP Radial Potted Type

**METALLIZED POLYPROPYLENE FILM CAPACITOR, MINI VERSION (M)**

CAPACITANCE	CAPACITANCE CODE	VOLTAGE CODE 25 250 V <sub>DC</sub> /160 V <sub>AC</sub>				VOLTAGE CODE 40 400 V <sub>DC</sub> /220 V <sub>AC</sub> <sup>(2)</sup>				VOLTAGE CODE 63 630 V <sub>DC</sub> /250 V <sub>AC</sub> <sup>(2)</sup>			
		w (mm)	h (mm)	l (mm)	PITCH (mm)	w (mm)	h (mm)	l (mm)	PITCH (mm)	w (mm)	h (mm)	l (mm)	PITCH (mm)
1000 pF	-210	-	-	-	-	-	-	-	-	3.0	6.5	7.5	5.0
1500 pF	-215	-	-	-	-	-	-	-	-	3.0	6.5	7.5	5.0
2200 pF	-222	-	-	-	-	-	-	-	-	3.5	8.5	7.5	5.0
3300 pF	-233	-	-	-	-	-	-	-	-	3.0	8.5	10.0	7.5
4700 pF	-247	-	-	-	-	-	-	-	-	3.0	8.5	10.0	7.5
6800 pF	-268	-	-	-	-	3.0	6.5	7.5	5.0	3.0	8.5	10.0	7.5
0.01 µF	-310	3.0	6.5	7.5	5.0	3.5	8.5	7.5	5.0	4.0	9.0	10.0	7.5
0.015 µF	-315	3.0	6.5	7.5	5.0	3.0	8.5	10.0	7.5	4.5	9.5	10.3	7.5
0.022 µF	-322	3.5	8.5	7.5	5.0	4.0	9.0	10.0	7.5	4.5	9.5	13.0	10.0
0.033 µF	-333	3.5	8.5	7.5	5.0	4.5	9.5	10.3	7.5	5.5	10.5	13.0	10.0
0.047 µF	-347	4.0	9.0	10.0	7.5	5.0	10.5	10.3	7.5	6.5	11.5	13.0	10.0
0.068 µF	-368	4.0	9.0	10.0	7.5	5.7	11.5	10.3	7.5	6.0	12.0	18.0	15.0
0.10 µF	-410	5.0	10.5	10.3	7.5	5.5	10.5	18.0	15.0	6.0	12.0	18.0	15.0
0.15 µF	-415	5.5	10.5	13.0	10.0	6.0	12.0	18.0	15.0	8.5	14.5	18.0	15.0
0.22 µF	-422	6.5	11.5	13.0	10.0	7.5	13.5	18.0	15.0	8.5	17.5	18.0	15.0
0.33 µF	-433	6.5	12.5	18.0	15.0	8.5	17.5	18.0	15.0	9.0	17.0	26.5	22.5
0.47 µF	-447	7.5	13.5	18.0	15.0	7.5	15.5	26.5	22.5	10.5	18.5	26.5	22.5
0.68 µF	-468	8.5	14.5	18.0	15.0	10.5	18.5	26.5	22.5	11.0	21.0	31.0	27.5
1.0 µF	-510	8.5	16.5	16.5	22.5	11.0	21.0	26.5	22.5	13.5	23.5	31.5	27.5
1.5 µF	-515	10.5	18.5	26.5	22.5	13.5	23.5	31.5	27.5	16.5	29.5	31.5	27.5
2.2 µF	-522	11.0	21.0	26.5	22.5	15.0	24.5	31.5	27.5	18.0	33.0	31.5	27.5
3.3 µF	-533	13.5	23.5	31.5	27.5	18.0	28.0	31.5	27.5	20.0	40.0	42.5	37.5
4.7 µF	-547	15.0	24.5	31.5	27.5	18.0	32.5	41.5	37.5	20.0	40.0	42.5	37.5
6.8 µF	-568	14.5	24.5	41.5	37.5	20.0	40.0	42.5	37.5	-	-	-	-

CAPACITANCE	CAPACITANCE CODE	VOLTAGE CODE 63 630 V <sub>DC</sub> /400 V <sub>AC</sub> <sup>(2)</sup>				VOLTAGE CODE 10 1000 V <sub>DC</sub> /500 V <sub>AC</sub> <sup>(2)</sup>			
		w (mm)	h (mm)	l (mm)	PITCH (mm)	w (mm)	h (mm)	l (mm)	PITCH (mm)
1000 pF	-210	-	-	-	-	-	-	-	-
1500 pF	-215	-	-	-	-	-	-	-	-
2200 pF	-222	-	-	-	-	-	-	-	-
3300 pF	-233	-	-	-	-	-	-	-	-
4700 pF	-247	-	-	-	-	4.0	9.0	13.0	10.0
6800 pF	-268	-	-	-	-	4.0	9.0	13.0	10.0
0.01 µF	-310	4.5	9.5	13.0	10.0 <sup>(1)</sup>	5.5	10.5	13.0	10.0
0.015 µF	-315	5.5	10.5	13.0	10.0 <sup>(1)</sup>	6.5	11.5	13.0	10.0
0.022 µF	-322	6.5	11.5	13.0	10.0 <sup>(1)</sup>	5.5	10.5	18.0	15.0
0.033 µF	-333	5.5	10.5	18.0	15.0 <sup>(1)</sup>	6.0	12.0	18.0	15.0
0.047 µF	-347	6.5	12.5	18.0	15.0 <sup>(1)</sup>	7.5	13.5	18.0	15.0
0.068 µF	-368	7.5	13.5	18.0	15.0 <sup>(1)</sup>	8.5	14.5	18.0	15.0
0.10 µF	-410	6.5	14.5	26.5	22.5 <sup>(1)</sup>	7.5	15.5	26.5	22.5
0.15 µF	-415	7.5	15.5	26.5	22.5 <sup>(1)</sup>	9.0	17.0	26.5	22.5
0.22 µF	-422	8.5	16.5	26.5	22.5 <sup>(1)</sup>	10.5	18.5	26.5	22.5
0.33 µF	-433	11.0	21.0	26.5	22.5 <sup>(1)</sup>	11.0	21.0	31.0	27.5
0.47 µF	-447	11.0	21.0	31.0	27.5 <sup>(1)</sup>	13.5	23.5	31.5	27.5
0.68 µF	-468	13.5	23.5	31.5	27.5 <sup>(1)</sup>	16.5	29.5	31.5	27.5
1.0 µF	-510	16.5	29.5	31.5	27.5 <sup>(1)</sup>	18.0	33.0	31.5	27.5
1.5 µF	-515	-	-	-	-	18.0	32.5	41.5	37.5

**Notes**

<sup>(1)</sup> Ordering code -2M (e.g. MKP 1840 410 635-2M)

<sup>(2)</sup> Not suitable for mains applications

• Further C-values upon request

• Please refer to X-capacitors in our catalog "RFI Suppression Components"

## RECOMMENDED PACKAGING

LETTER CODE	TYPE OF PACKAGING	HEIGHT (H) (mm)	REEL DIAMETER (mm)	ORDERING CODE EXAMPLES	PITCH ≤ 15	PITCH 22.5 - 27.5	PITCH 37.5
G	Ammo	18.5	S <sup>(1)</sup>	MKP1840410404MG	x	-	-
W	Reel	18.5	350	MKP1840410404MW	x	-	-
V	Reel	18.5	500	MKP1840510254MV	-	x	-
G	Ammo	18.5	L <sup>(2)</sup>	MKP1840510254MG	-	x	-
-	Bulk	-	-	MKP1840510254M	x	x	x

### Notes

<sup>(1)</sup> S = box size 55 mm x 210 mm x 340 mm (w x h x l)

<sup>(2)</sup> L = box size 60 mm x 360 mm x 510 mm (w x h x l)

## EXAMPLE OF ORDERING CODE

TYPE	CAPACITANCE CODE	VOLTAGE CODE	TOLERANCE CODE	MINI	PACKAGING CODE
MKP1840	447	63	4	M	G
Tolerance codes: 4 = 5 % (J); 3 = 2.5 % (H)					

## METALLIZED POLYPROPYLENE FILM CAPACITOR, MKP 1840 PCM5, MINI VERSION (-5M)

CAPACITANCE	CAPACITANCE CODE	VOLTAGE CODE 25 250 V <sub>DC</sub> /160 V <sub>AC</sub>				VOLTAGE CODE 40 400 V <sub>DC</sub> /220 V <sub>AC</sub> <sup>(1)</sup>				VOLTAGE CODE 63 630 V <sub>DC</sub> /250 V <sub>AC</sub> <sup>(1)</sup>			
		w (mm)	h (mm)	l (mm)	PITCH (mm)	w (mm)	h (mm)	l (mm)	PITCH (mm)	w (mm)	h (mm)	l (mm)	PITCH (mm)
<b>d<sub>t</sub> = 0.5 ± 0.05</b>													
3300 pF	-233	-	-	-	-	-	-	-	-	3.5	8.5	7.5	5.0
4700 pF	-247	-	-	-	-	-	-	-	-	3.5	8.5	7.5	5.0
6800 pF	-268	-	-	-	-	-	-	-	-	4.5	9.5	7.5	5.0
0.01 μF	-310	-	-	-	-	-	-	-	-	4.5	9.5	7.5	5.0
0.015 μF	-315	-	-	-	-	4.5	9.5	7.5	5.0	5.5	11.5	7.5	5.0
0.022 μF	-322	-	-	-	-	4.5	9.5	7.5	5.0	-	-	-	-
0.033 μF	-333	-	-	-	-	5.5	11.5	7.5	5.0	-	-	-	-
0.047 μF	-347	4.5	9.5	7.5	5	5.5	11.5	7.5	5.0	-	-	-	-
0.068 μF	-368	5.0	10.0	7.5	5	-	-	-	-	-	-	-	-
0.10 μF	-410	5.5	11.5	7.5	5	-	-	-	-	-	-	-	-

LETTER CODE	TYPE OF PACKAGING	HEIGHT (H) (mm)	REEL DIAMETER (mm)	ORDERING CODE EXAMPLE	PITCH 5
G	Ammo	18.5	S <sup>(2)</sup>	MKP18403104045MG	X
W	Reel	18.5	350	MKP18403104045MW	X
-	Bulk	-	-	MKP18403104045M	X

### Notes

<sup>(1)</sup> Not suitable for mains applications

<sup>(2)</sup> S = box size 55 mm x 210 mm x 340 mm (w x h x l)

- Further C-values upon request

## EXAMPLE OF ORDERING CODE

TYPE	CAPACITANCE CODE	VOLTAGE CODE	TOLERANCE CODE	MINI	PACKAGING CODE
MKP1840	347	25	4	5M	G
Tolerance codes: 4 = 5 % (J); 3 = 2.5 % (H)					

## MOUNTING

### Normal Use

The capacitors are designed for mounting on printed-circuit boards. The capacitors packed in bandoliers are designed for mounting in printed-circuit boards by means of automatic insertion machines.

For detailed tape specifications refer to "Packaging Information" [www.vishay.com/doc?28139](http://www.vishay.com/doc?28139) or end of catalog

### Specific Method of Mounting to Withstand Vibration and Shock

In order to withstand vibration and shock tests, it must be ensure that the stand-off pips are in good contact with the printed-circuit board:

- For pitches  $\leq 15$  mm capacitors shall be mechanically fixed by the leads
- For larger pitches the capacitors shall be mounted in the same way and the body clamped

### Space Requirements on Printed-Circuit Board

The maximum length and width of film capacitors is shown in the drawing:

- Eccentricity as in drawing. The maximum eccentricity is smaller than or equal to the lead diameter of the product concerned
- Product height with seating plane as given by "IEC 60717" as reference:  $h_{\max.} \leq h + 0.4$  mm or  $h'_{\max.} \leq h' + 0.4$  mm

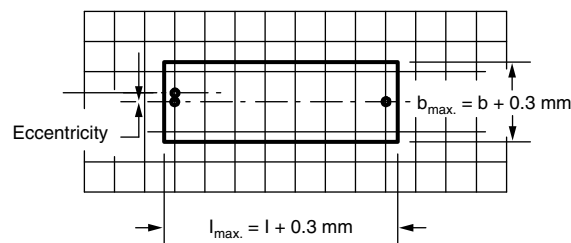

### Storage Temperature

- Storage temperature:  $T_{\text{stg}} = -25$  °C to  $+40$  °C with RH maximum 80 % without condensation

### Ratings and Characteristics Reference Conditions

Unless otherwise specified, all electrical values apply to an ambient free temperature of  $23$  °C  $\pm 1$  °C, an atmospheric pressure of 86 kPa to 106 kPa and a relative humidity of  $50$  %  $\pm 2$  %.

For reference testing, a conditioning period shall be applied over  $96$  h  $\pm 4$  h by heating the products in a circulating air oven at the rated temperature and a relative humidity not exceeding 20 %.

## CHARACTERISTICS

Max. RMS voltage as a function of frequency

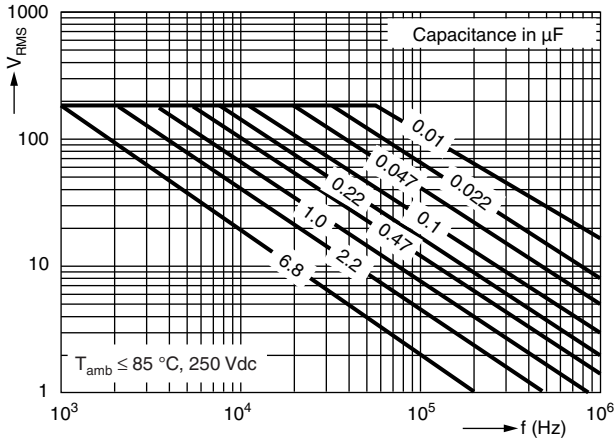

Max. RMS voltage as a function of frequency

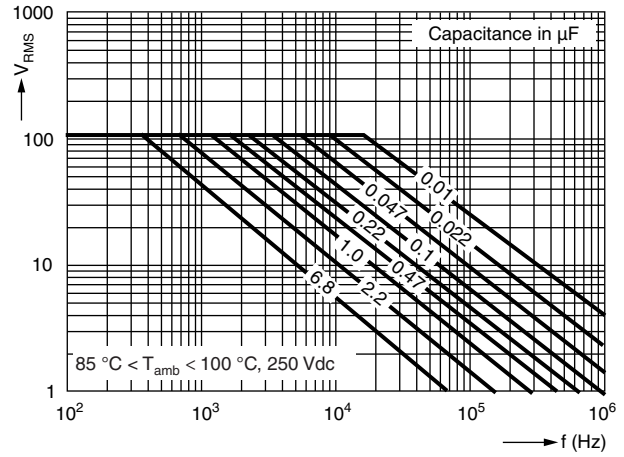

Max. RMS voltage as a function of frequency

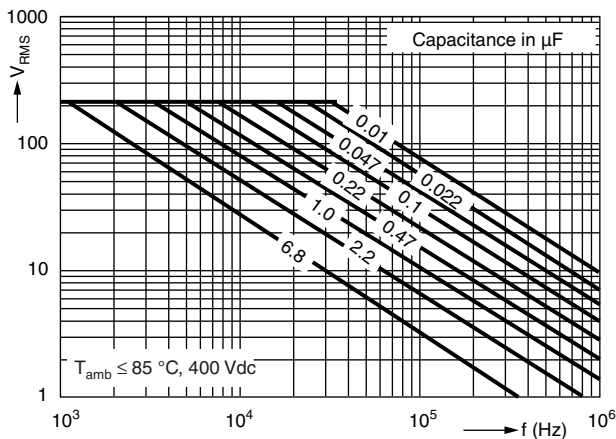

Max. RMS voltage as a function of frequency

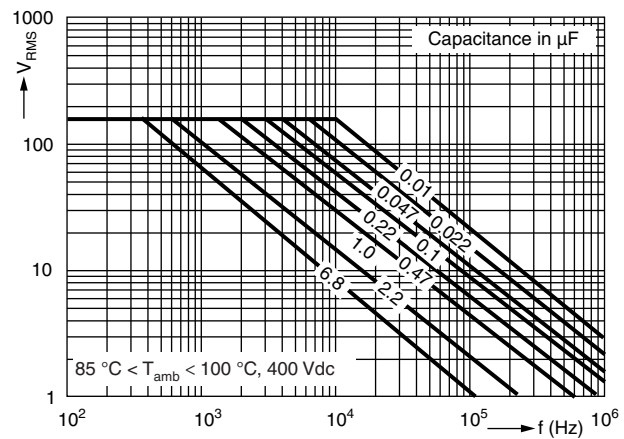

Max. RMS voltage as a function of frequency

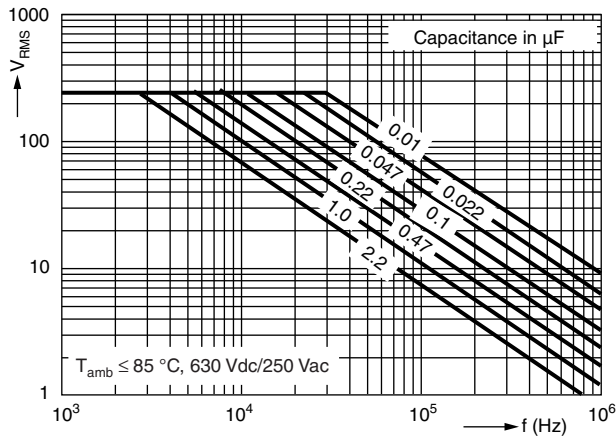

Max. RMS voltage as a function of frequency

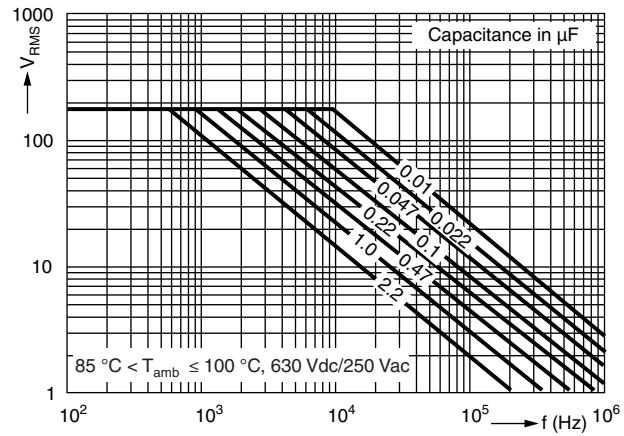



AC and Pulse Metallized Polypropylene Film Capacitors Vishay Roederstein  
MKP Radial Potted Type

Max. RMS voltage as a function of frequency

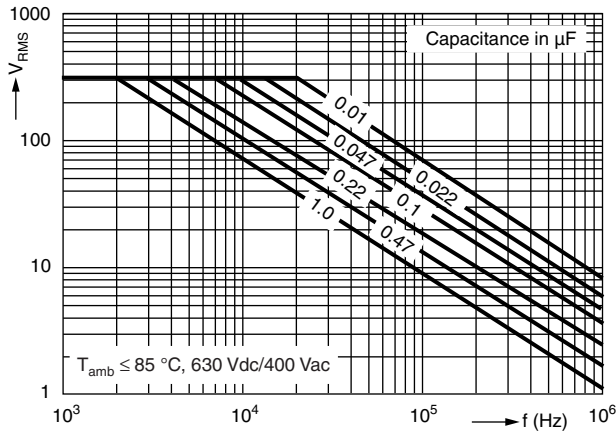

Max. RMS voltage as a function of frequency

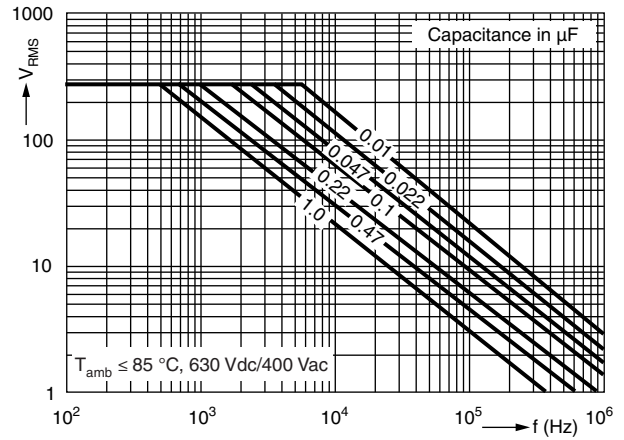

Max. RMS voltage as a function of frequency

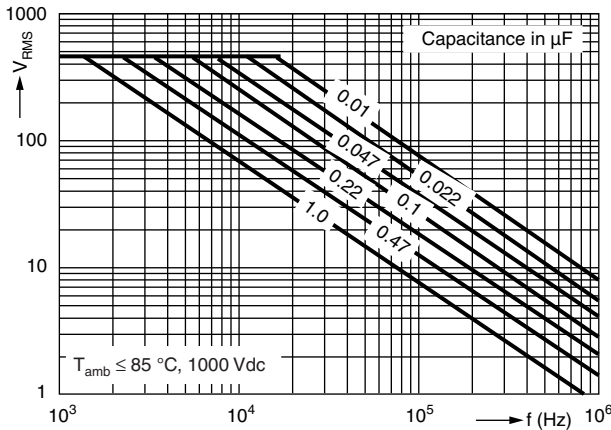

Max. RMS voltage as a function of frequency

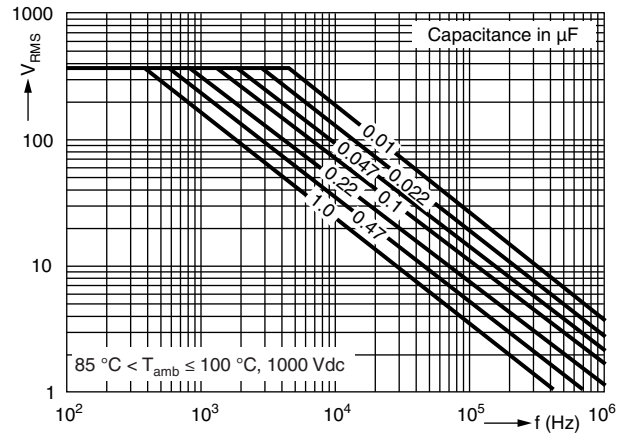

## HEAT CONDUCTIVITY (G) AS A FUNCTION OF ORIGINAL PITCH AND CAPACITOR BODY THICKNESS IN mW/°C

W <sub>max.</sub> (mm)	HEAT CONDUCTIVITY (mW/°C)						
	PITCH 5 mm	PITCH 7.5 mm	PITCH 10 mm	PITCH 15 mm	PITCH 22.5 mm	PITCH 27.5 mm	PITCH 37.5 mm
3.0	2.5	4.0	-	-	-	-	-
3.5	3.5	-	-	-	-	-	-
4.0	-	5.0	6.0	-	-	-	-
4.5	4.5	5.5	6.5	-	-	-	-
5.0	5.0	6.5	-	-	-	-	-
5.5	6.5	-	7.5	9.0	-	-	-
5.7	-	7.5	-	-	-	-	-
6.0	-	-	-	10.5	-	-	-
6.5	-	-	9.0	11.5	17.0	-	-
7.5	-	-	-	13.5	19.0	-	-
8.5	-	-	-	15.0	16.5	-	-
9.0	-	-	-	-	22.5	-	-
10.5	-	-	-	-	26.5	-	-
11.0	-	-	-	-	30.5	-	-
11.5	-	-	-	-	-	33.5	-
13.5	-	-	-	-	-	41.0	-
14.5	-	-	-	-	-	-	52.0
15.0	-	-	-	-	-	45.0	-
16.5	-	-	-	-	-	57.0	-
18.0	-	-	-	-	-	57.0	-
18.0	-	-	-	-	-	67.0	-
18.0	-	-	-	-	-	-	75.5
20.0	-	-	-	-	-	-	99.0

### POWER DISSIPATION AND MAXIMUM COMPONENT TEMPERATURE RISE

The power dissipation must be limited in order not to exceed the maximum allowed component temperature rise as a function of the free air ambient temperature.

The power dissipation can be calculated according type detail specification "HQN-384-01/101: Technical Information Film Capacitors" with the typical tgδ of the curves.

The component temperature rise ( $\Delta T$ ) can be measured (see section "Measuring the Component Temperature" for more details) or calculated by  $\Delta T = P/G$ :

- $\Delta T$  = Component temperature rise (°C)
- P = Power dissipation of the component (mW)
- G = Heat conductivity of the component (mW/°C)

### MEASURING THE COMPONENT TEMPERATURE

A thermocouple must be attached to the capacitor body as in:

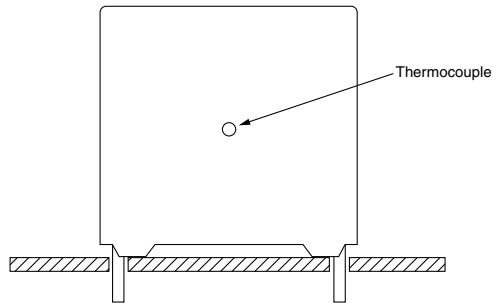

The temperature is measured in unloaded ( $T_{amb}$ ) and maximum loaded condition ( $T_C$ ).

The temperature rise is given by  $\Delta T = T_C - T_{amb}$ .

To avoid radiation or convection, the capacitor should be tested in a wind-free box.

### APPLICATION NOTE AND LIMITING CONDITIONS

These capacitors are not suitable for mains applications as across-the-line capacitors without additional protection, as described hereunder. These mains applications are strictly regulated in safety standards and therefore electromagnetic interference suppression capacitors conforming the standards must be used.

To select the capacitor for a certain application, the following conditions must be checked:

1. The peak voltage ( $U_P$ ) shall not be greater than the rated DC voltage ( $U_{Rdc}$ )
2. The peak-to-peak voltage ( $U_{P-P}$ ) shall not be greater than the maximum ( $U_{P-p}$ ) to avoid the ionisation inception level
3. The voltage peak slope ( $dU/dt$ ) shall not exceed the rated voltage pulse slope in an RC-circuit at rated voltage and without ringing. If the pulse voltage is lower than the rated DC voltage, the rated voltage pulse slope may be multiplied by  $U_{Rdc}$  and divided by the applied voltage.

For all other pulses following equation must be fulfilled:

$$2 \times \int_0^T \left( \frac{dU}{dt} \right)^2 \times dt < U_{Rdc} \times \left( \frac{dU}{dt} \right)_{rated}$$

T is the pulse duration

4. The maximum component surface temperature rise must be lower than the limits (see graph max. allowed component temperature rise).
5. Since in circuits used at voltages over 280 V peak-to-peak the risk for an intrinsically active flammability after a capacitor breakdown (short circuit) increases, it is recommended that the power to the component is limited to 100 times the values mentioned in the table: "Heat conductivity"
6. When using these capacitors as across-the-line capacitor in the input filter for mains applications or as series connected with an impedance to the mains the applicant must guarantee that the following conditions are fulfilled in any case (spikes and surge voltages from the mains included).

#### Voltage Conditions for 6 Above

ALLOWED VOLTAGES	$T_{amb} \leq 85 \text{ }^\circ\text{C}$	$85 \text{ }^\circ\text{C} < T_{amb} \leq 100 \text{ }^\circ\text{C}$
Maximum continuous RMS voltage	$U_{Rac}$	$U_{Rac}$
Maximum temperature RMS-overvoltage (< 24 h)	$1.25 \times U_{Rac}$	$1.25 \times U_{Rac}$
Maximum peak voltage ( $V_{O-P}$ ) (< 2 s)	$1.6 \times U_{Rdc}$	$1.1 \times U_{Rdc}$

## INSPECTION REQUIREMENTS

### General Notes:

Sub-clause numbers of tests and performance requirements refer to the “Sectional Specification, Publication IEC 60384-2 and Specific Reference Data”.

### Group C Inspection Requirements

SUB-CLAUSE NUMBER AND TEST	CONDITIONS	PERFORMANCE REQUIREMENTS
<b>SUB-GROUP C1A PART OF SAMPLE OF SUB-GROUP C1</b>		
4.1 Dimensions (detail)		As specified in chapter “General Data” of this specification
4.3.1 Initial measurements	Capacitance Tangent of loss angle at 10 kHz	
4.3 Robustness of terminations	Tensile and bending	No visible damage
4.4 Resistance to soldering heat	Method: 1A Solder bath: 280 °C ± 5 °C Duration: 5 s	
4.14 Component solvent resistance	Isopropylalcohol at room temperature Method: 2 Immersion time: 5 min ± 0.5 min Recovery time: Min. 1 h, max. 2 h	
4.4.2 Final measurements	Visual examination  Capacitance  Tangent of loss angle	No visible damage Legible marking  $ \Delta C/C  \leq 2\%$ of the value measured initially  Increase of $\tan \delta$ $\leq 0.002$ Compared to values measured in 4.3.1
<b>SUB-GROUP C1B PART OF SAMPLE OF SUB-GROUP C1</b>		
4.6.1 Initial measurements	Capacitance Tangent of loss angle: at 100 kHz	No visible damage
4.15 Solvent resistance of the marking	Isopropylalcohol at room temperature Method: 1 Rubbing material: cotton wool Immersion time: 5 min ± 0.5 min	No visible damage Legible marking
4.6 Rapid change of temperature	$\theta A$ = lower category temperature $\theta B$ = upper category temperature 5 cycles Duration $t = 30$ min	
4.7 Vibration	Visual examination Mounting: See section “Mounting” of this specification Procedure B4 Frequency range: 10 Hz to 55 Hz Amplitude: 0.75 mm or Acceleration 98 m/s <sup>2</sup> (whichever is less severe) Total duration 6 h	No visible damage Legible marking
4.7.2 Final inspection	Visual examination	No visible damage
4.9 Shock	Mounting: See section “Mounting” for more information Pulse shape: Half sine Acceleration: 490 m/s <sup>2</sup> Duration of pulse: 11 ms	



**AC and Pulse Metallized Polypropylene Film Capacitors Vishay Roederstein  
MKP Radial Potted Type**

SUB-CLAUSE NUMBER AND TEST	CONDITIONS	PERFORMANCE REQUIREMENTS
<b>SUB-GROUP C1B PART OF SAMPLE OF SUB-GROUP C1</b>		
4.9.3 Final measurements	Visual examination Capacitance Tangent of loss angle  Insulation resistance	No visible damage $ \Delta C/C  \leq 2\%$ of the value measured in 4.6.1 Increase of $\tan \delta \leq 0.002$ Compared to values measured in 4.6.1 As specified in section "Insulation Resistance" of this specification
<b>SUB-GROUP C1 COMBINED SAMPLE OF SPECIMENS OF SUB-GROUPS C1A AND C1B</b>		
4.10 Climatic sequence  4.10.2 Dry heat  4.10.3 Damp heat cyclic Test Db, first cycle  4.10.4 Cold  4.10.6 Damp heat cyclic Test Db, remaining cycles  4.10.6.2 Final measurements	Temperature: upper category temperature Duration: 16 h  Temperature: lower category temperature Duration: 2 h  Visual examination  Capacitance  Tangent of loss angle  Insulation resistance	No visible damage Legible marking $ \Delta C/C  \leq 3\%$ of the value measured in 4.4.2 or 4.9.3 Increase of $\tan \delta: \leq 0.003$ Compared to values measured in 4.3.1 or 4.6.1 $\geq 50\%$ of values specified in section "Insulation Resistance" of this specification
<b>SUB-GROUP C2</b>		
4.11 Damp heat steady state  4.11.1 Initial measurements  4.11.3 Final measurements	Capacitance Tangent of loss angle at 1 kHz Visual examination  Capacitance  Tangent of loss angle  Insulation resistance	No visible damage Legible marking $ \Delta C/C  \leq 3\%$ of the value measured in 4.11.1. Increase of $\tan \delta \leq 0.002$ Compared to values measured in 4.11.1 $\geq 50\%$ of values specified in section "Insulation Resistance" of this specification
<b>SUB-GROUP C3</b>		
4.12 Endurance  4.12.1 Initial measurements  4.12.5 Final measurements	Duration: 2000 h $\times U_{Rdc}$ at 85 °C $0.875 \times U_{Rdc}$ at 100 °C Capacitance Tangent of loss angle at 100 kHz Visual examination  Capacitance  Tangent of loss angle  Insulation resistance	No visible damage Legible marking $ \Delta C/C  \leq 3\%$ compared to values measured in 4.12.1 Increase of $\tan \delta: \leq 0.004$ Compared to values measured in 4.12.1 $\geq 50\%$ of values specified in section "Insulation Resistance" of this specification



SUB-CLAUSE NUMBER AND TEST	CONDITIONS	PERFORMANCE REQUIREMENTS
<b>SUB-GROUP C4</b>		
4.2.6 Temperature characteristics Initial measurements Intermediate measurements   Final measurements	Capacitance Capacitance at lower category temperature Capacitance at 20 °C Capacitance at upper category temperature   Capacitance Insulation resistance	For - 55 °C to + 20 °C: $0\% \leq  \Delta C/C  \leq 2\%$ or For 20 °C to 85 °C $-3\% \leq  \Delta C/C  \leq 0\%$ As specified in section "Capacitance" of this specification  As specified in section "Insulation Resistance" of this specification
<b>SUB-GROUP C4</b>		
4.13 Charge and discharge   4.13.1 Initial measurements  4.13.3 Final measurements	10 000 cycles Charged to $U_{Rdc}$ Discharge resistance:  $R = \frac{U_R}{2.5 \times C \times (dU/dt)}$  Capacitance Tangent of loss angle at 100 kHz  Capacitance   Tangent of loss angle   Insulation resistance	$ \Delta C/C  \leq 3\%$ compared to values measured in 4.13.1  Increase of $\tan \delta \leq 0.005$ Compared to values measured in 4.13.1  $\geq 50\%$ of values specified in section "Insulation Resistance" of this specification



## Disclaimer

ALL PRODUCT, PRODUCT SPECIFICATIONS AND DATA ARE SUBJECT TO CHANGE WITHOUT NOTICE TO IMPROVE RELIABILITY, FUNCTION OR DESIGN OR OTHERWISE.

Vishay Intertechnology, Inc., its affiliates, agents, and employees, and all persons acting on its or their behalf (collectively, "Vishay"), disclaim any and all liability for any errors, inaccuracies or incompleteness contained in any datasheet or in any other disclosure relating to any product.

Vishay makes no warranty, representation or guarantee regarding the suitability of the products for any particular purpose or the continuing production of any product. To the maximum extent permitted by applicable law, Vishay disclaims (i) any and all liability arising out of the application or use of any product, (ii) any and all liability, including without limitation special, consequential or incidental damages, and (iii) any and all implied warranties, including warranties of fitness for particular purpose, non-infringement and merchantability.

Statements regarding the suitability of products for certain types of applications are based on Vishay's knowledge of typical requirements that are often placed on Vishay products in generic applications. Such statements are not binding statements about the suitability of products for a particular application. It is the customer's responsibility to validate that a particular product with the properties described in the product specification is suitable for use in a particular application. Parameters provided in datasheets and/or specifications may vary in different applications and performance may vary over time. All operating parameters, including typical parameters, must be validated for each customer application by the customer's technical experts. Product specifications do not expand or otherwise modify Vishay's terms and conditions of purchase, including but not limited to the warranty expressed therein.

Except as expressly indicated in writing, Vishay products are not designed for use in medical, life-saving, or life-sustaining applications or for any other application in which the failure of the Vishay product could result in personal injury or death. Customers using or selling Vishay products not expressly indicated for use in such applications do so at their own risk. Please contact authorized Vishay personnel to obtain written terms and conditions regarding products designed for such applications.

No license, express or implied, by estoppel or otherwise, to any intellectual property rights is granted by this document or by any conduct of Vishay. Product names and markings noted herein may be trademarks of their respective owners.

## Material Category Policy

**Vishay Intertechnology, Inc. hereby certifies that all its products that are identified as RoHS-Compliant fulfill the definitions and restrictions defined under Directive 2011/65/EU of The European Parliament and of the Council of June 8, 2011 on the restriction of the use of certain hazardous substances in electrical and electronic equipment (EEE) - recast, unless otherwise specified as non-compliant.**

**Please note that some Vishay documentation may still make reference to RoHS Directive 2002/95/EC. We confirm that all the products identified as being compliant to Directive 2002/95/EC conform to Directive 2011/65/EU.**

**Vishay Intertechnology, Inc. hereby certifies that all its products that are identified as Halogen-Free follow Halogen-Free requirements as per JEDEC JS709A standards. Please note that some Vishay documentation may still make reference to the IEC 61249-2-21 definition. We confirm that all the products identified as being compliant to IEC 61249-2-21 conform to JEDEC JS709A standards.**

## Looking for pricing, stock, or lifecycle information?

Click below to explore more details on WIN SOURCE:

 [View MKP1840522254M on WIN SOURCE](#)

 [Vishay Information](#)

## Optimize Your Supply Chain with WIN SOURCE Solutions

-  Global Sourcing Solution
-  Obsolete Management
-  Cost Control Management
-  Shortage Management
-  Alternative Solution
-  Excess Inventory Management