



MIC6315

Open-Drain μ P Reset Circuit

General Description

The MIC6315 is an inexpensive reset generator circuit that monitors power supplies in microprocessor-based systems.

The function of this device is to assert a reset if either the power supply drops below a designated reset threshold level or $/MR$ is forced low. Several different reset threshold levels are available to accommodate 3V, 3.3V, or 5V powered systems.

The MIC6315 has an active low, open-drain $/RESET$ output. The reset output is guaranteed to remain asserted for a minimum of either 20ms, 140ms, or 1100ms after V_{CC} has risen above the designed reset threshold level. The MIC6315 is available in a 4-pin SOT-143 package.

Datasheets and support documentation are available on Micrel's web site at: www.micrel.com.

Features

- Precision voltage monitor for 3V, 3.3V, or 5V power supplies
- $/RESET$ remains valid with V_{CC} as low as 1V
- 5 μ A supply current
- 20ms, 140ms, or 1100ms minimum reset pulse widths available
- Manual reset input
- Available in 4-pin SOT-143 package

Applications

- Portable equipment
- Intelligent instruments
- Critical microprocessor power monitoring
- Printers/computers
- Embedded controllers

Typical Application

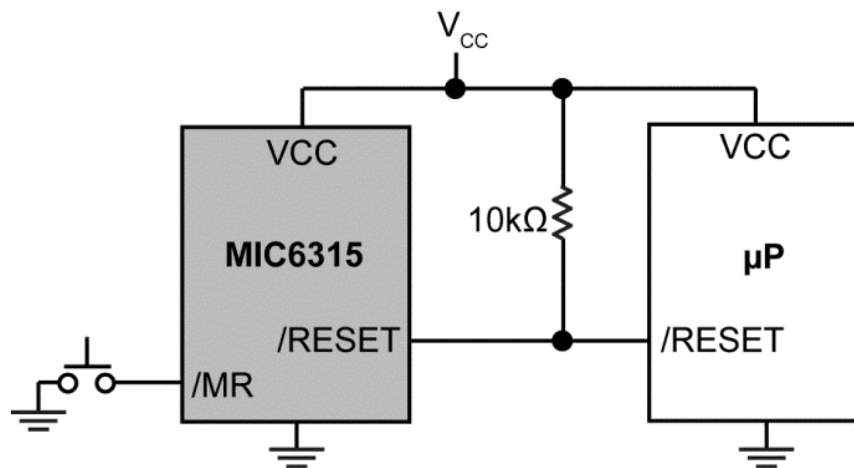

Ordering Information

Part Number ^(1,2)	Marking ⁽³⁾	Nominal V _{TH} (V)	Minimum t _{RST} (ms)	Operating Temperature Range	Package	Lead Finish
MIC6315-26D2UY	<u>NY</u>	2.63	20	-40°C to +85°C	4-Pin SOT-143	Pb-Free
MIC6315-29D2UY	<u>NM</u>	2.93	20	-40°C to +85°C	4-Pin SOT-143	Pb-Free
MIC6315-30D2UY	<u>N2</u>	3.00	20	-40°C to +85°C	4-Pin SOT-143	Pb-Free
MIC6315-31D2UY	<u>NF</u>	3.08	20	-40°C to +85°C	4-Pin SOT-143	Pb-Free
MIC6315-40D2UY	<u>NW</u>	4.00	20	-40°C to +85°C	4-Pin SOT-143	Pb-Free
MIC6315-41D2UY	<u>N6</u>	4.10	20	-40°C to +85°C	4-Pin SOT-143	Pb-Free
MIC6315-44D2UY	<u>NG</u>	4.38	20	-40°C to +85°C	4-Pin SOT-143	Pb-Free
MIC6315-46D2UY	<u>NQ</u>	4.63	20	-40°C to +85°C	4-Pin SOT-143	Pb-Free
MIC6315-26D3UY	<u>NR</u>	2.63	140	-40°C to +85°C	4-Pin SOT-143	Pb-Free
MIC6315-29D3UY	<u>NP</u>	2.93	140	-40°C to +85°C	4-Pin SOT-143	Pb-Free
MIC6315-30D3UY	<u>N3</u>	3.00	140	-40°C to +85°C	4-Pin SOT-143	Pb-Free
MIC6315-31D3UY	<u>NU</u>	3.08	140	-40°C to +85°C	4-Pin SOT-143	Pb-Free
MIC6315-40D3UY	<u>N8</u>	4.00	140	-40°C to +85°C	4-Pin SOT-143	Pb-Free
MIC6315-41D3UY	<u>N5</u>	4.10	140	-40°C to +85°C	4-Pin SOT-143	Pb-Free
MIC6315-42D3UY	<u>05</u>	4.20	140	-40°C to +85°C	4-Pin SOT-143	Pb-Free
MIC6315-44D3UY	<u>NH</u>	4.38	140	-40°C to +85°C	4-Pin SOT-143	Pb-Free
MIC6315-46D3UY	<u>NX</u>	4.63	140	-40°C to +85°C	4-Pin SOT-143	Pb-Free
MIC6315-26D4UY	<u>NS</u>	2.63	1100	-40°C to +85°C	4-Pin SOT-143	Pb-Free
MIC6315-29D4UY	<u>NN</u>	2.93	1100	-40°C to +85°C	4-Pin SOT-143	Pb-Free
MIC6315-30D4UY	<u>N4</u>	3.00	1100	-40°C to +85°C	4-Pin SOT-143	Pb-Free
MIC6315-31D4UY	<u>2N</u>	3.08	1100	-40°C to +85°C	4-Pin SOT-143	Pb-Free
MIC6315-40D4UY	<u>M9</u>	4.00	1100	-40°C to +85°C	4-Pin SOT-143	Pb-Free
MIC6315-41D4UY	<u>M7</u>	4.10	1100	-40°C to +85°C	4-Pin SOT-143	Pb-Free
MIC6315-44D4UY	<u>NJ</u>	4.38	1100	-40°C to +85°C	4-Pin SOT-143	Pb-Free
MIC6315-46D4UY	<u>NZ</u>	4.63	1100	-40°C to +85°C	4-Pin SOT-143	Pb-Free

Note:

1. Ship format Tape and reel only (ordering part number add space TR example. MIC6315-26D2UY TR).
2. Standard reel quantity is 3000 pieces.
Reel diameter 7in. / Hub diameter 2in. / Width 8mm.
3. Underbar symbol () may not be to scale.

Pin Configuration

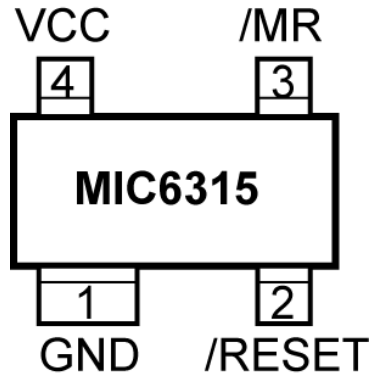

4-Pin SOT-143 (U)
(Top View)

Pin Description

Pin Number	Pin Name	Pin Function
1	GND	IC Ground.
2	/RESET	/RESET goes low if V_{CC} falls below the reset threshold and remains asserted for one reset timeout period after V_{CC} exceeds the reset threshold.
3	/MR	Manual Reset Input: A logic LOW on /MR forces a reset. The reset will remain asserted as long as /MR is held LOW and for one reset timeout period after /MR goes HIGH. This input can be shorted to ground via a switch or be driven by TTL or CMOS logic. Float if unused.
4	VCC	Power Supply Input.

Absolute Maximum Ratings⁽⁴⁾

Terminal Voltage	
(VCC, /RESET).....	-0.3V to +6.0V
(/MR).....	-0.3V to (V _{CC} + 0.3V)
Rate-of-Rise (VCC).....	100V/μs
Input Current (VCC, /MR).....	20mA
Output Current (/RESET).....	20mA
Lead Temperature (soldering, 10s).....	300°C
Storage Temperature (T _S).....	-65°C to +150°C
ESD Rating ⁽⁶⁾	3kV

Operating Ratings⁽⁵⁾

Input Voltage (/RESET).....	GND to 5.5V
Operating Temperature Range.....	-40°C to +85°C
Junction Temperature (T _J).....	-40°C to +125°C
Power Dissipation (T _A = +70°C).....	320mW

Electrical Characteristics

For typical values, V_{CC} = 2.5V to 5.5V; T_A = +25°C, **bold** values indicate -40°C ≤ T_A ≤ +85°C, unless noted.

Symbol	Parameter	Condition	Min.	Typ.	Max.	Units
V _{CC}	Operating Voltage Range		1		5.5	V
I _{CC}	Supply Current	V _{CC} = 5.5V, no load.		5	15	μA
		V _{CC} = 3.6V, no load.		5	10	
V _{TH}	Reset Voltage Threshold	Note 7	V_{TH} - 2.5%	V _{TH}	V_{TH} + 2.5%	V
t _{RST}	Reset Timeout Period	D2U	20	28	44	ms
		D3U	140	200	320	
		D4U	1100	1500	2500	
V _{OL}	/RESET Output Voltage	V _{CC} ≥ 4.0V, t _{SINK} = 3.2mA			0.4	V
		V _{CC} ≥ 2.5V, t _{SINK} = 1.2mA			0.3	
		V _{CC} ≥ 1.0V, t _{SINK} = 50μA			0.3	
	/RESET Output Leakage	/RESET de-asserted			1	μA
	/MR Minimum Pulse Width		10			μs
	/MR-to-Reset Delay			0.5		μs
V _{IH}	/MR Input Threshold	V _{TH} > 4.0V	2.3			V
		V _{TH} < 4.0V	0.7 × V_{CC}			
V _{IL}	/MR Input Threshold	V _{TH} > 4.0V			0.8	V
		V _{TH} < 4.0V			0.25 × V_{CC}	
	/MR Pull-Up Resistance		10	20	30	kΩ
	/MR Glitch Immunity			100		ns

Notes:

- Exceeding the absolute maximum ratings may damage the device.
- The device is not guaranteed to function outside its operating ratings.
- Devices are ESD sensitive. Handling precautions are recommended. Human body model, 1.5kΩ in series with 100pF.
- Various reset thresholds available. See [Ordering Information](#) or contact factory.

Timing Diagram



Functional Diagram

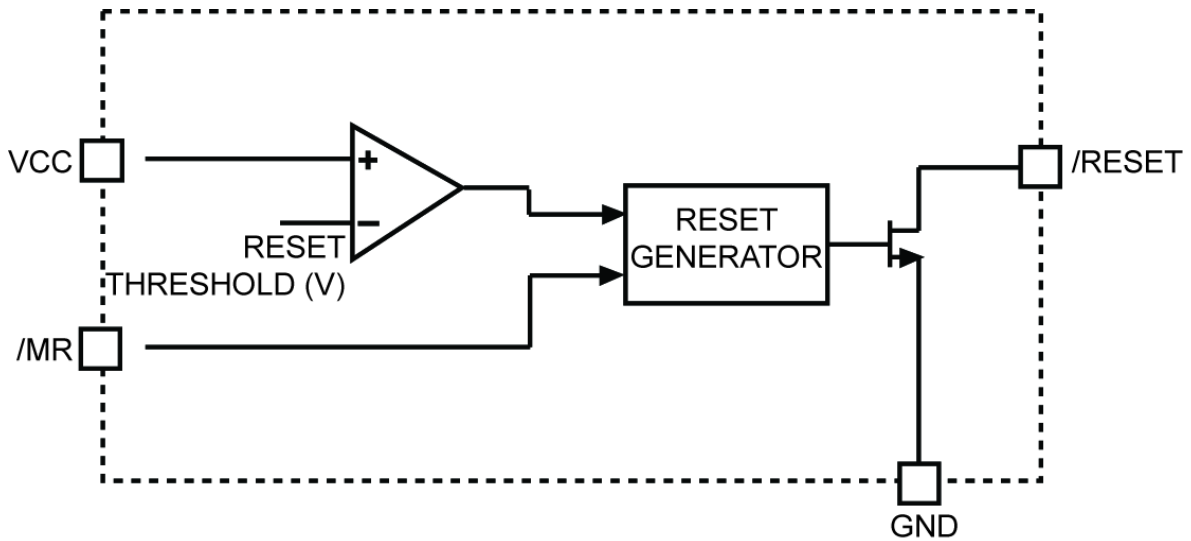

Application Information

Microprocessor Reset

The /RESET pin is asserted whenever V_{CC} falls below the reset threshold voltage or if /MR (manual reset) is forced low. The /RESET pin remains asserted for the duration of the reset timeout period after V_{CC} has risen above the reset threshold or /MR has returned high. The reset function ensures the microprocessor is properly reset and powers up in a known condition after a power failure. /RESET will remain valid with V_{CC} as low as 1V.

The /RESET output is a simple open-drain N-channel MOSFET structure. A pull-up resistor must be used to pull this output up to some voltage. For most applications, this voltage will be the same power supply that supplies V_{CC} to the MIC6315. It is possible, however, to tie this resistor to some other voltage. This will allow the MIC6315 to monitor one voltage while level-shifting the /RESET output to some other voltage. The pull-up voltage must be limited to 6.0V or less (absolute maximum) to avoid damage to the MIC6315. The resistor must be small enough to supply current to the inputs and leakage paths that are driven by the /RESET output.

/RESET Valid at Low Voltage

As V_{CC} drops to 0V, the MIC6315 will no longer be able to pull the /RESET output low. At this point, the pull-up resistor will pull the output high. The value of the pull-up resistor and the voltage it is connected to will affect the point at which this happens.

Wire OR'ing the /RESET Output

Because the RESET output is open-drain, several reset sources can be wire-OR'ed, in parallel, to allow resets from multiple sources.

V_{CC} Transients

The MIC6315 is relatively immune to negative-going V_{CC} glitches below the reset threshold. Typically, a negative-going transient 125mV below the reset threshold with duration of 20 μ s or less will not cause an unwanted reset. If additional transient immunity is needed, a bypass capacitor can be placed as close as possible to the MIC6315.

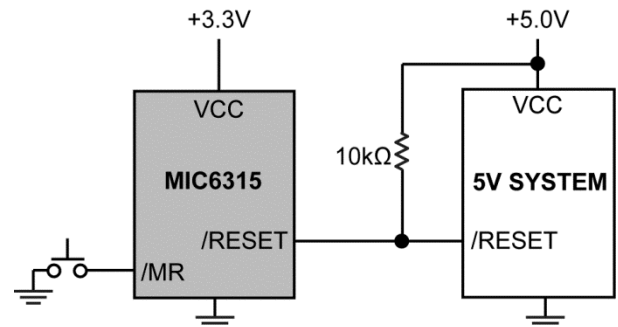
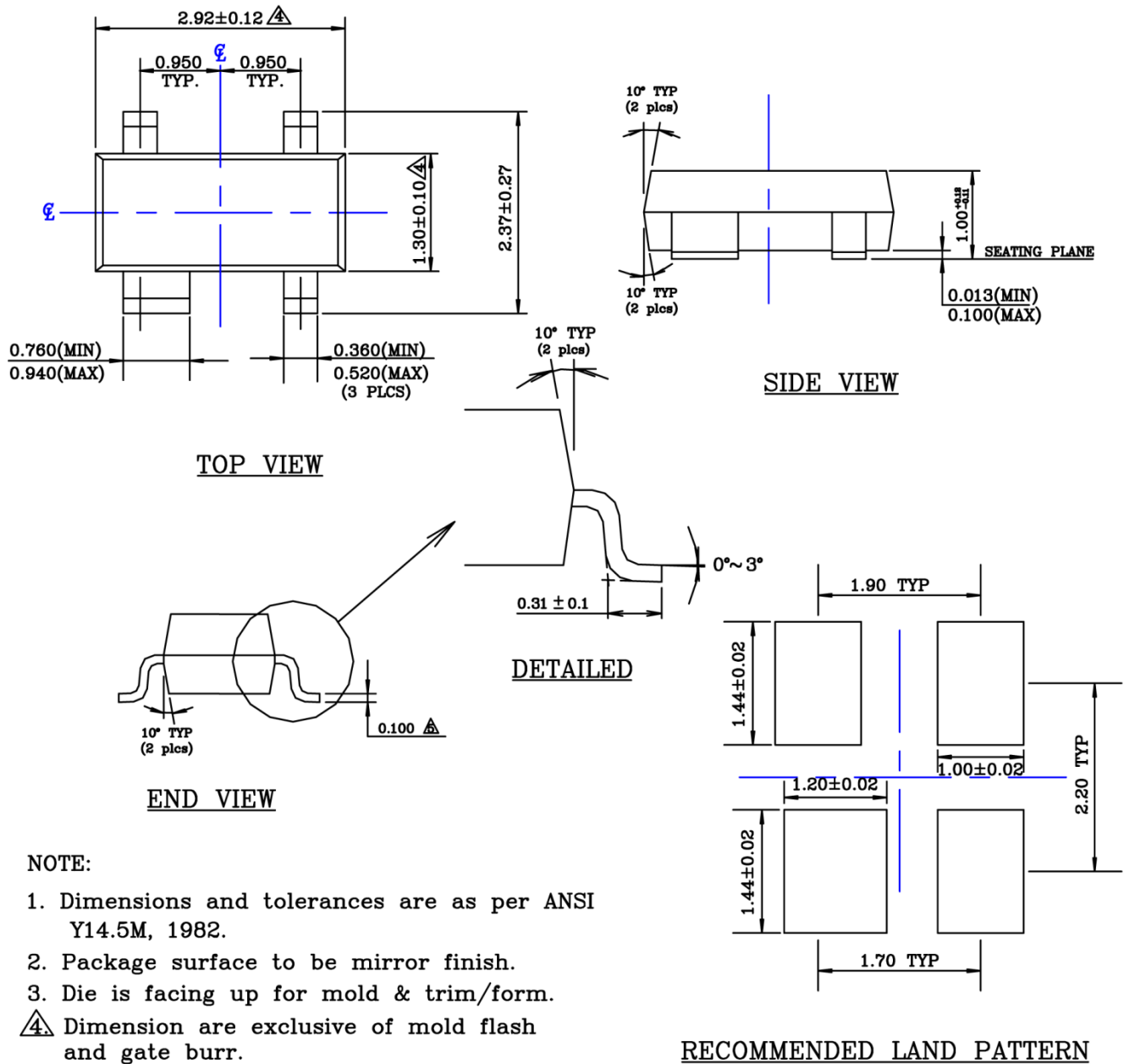

Figure 1. MIC6315 as Used in a Multiple Supply System

Package Information and Recommended Landing Pattern⁽⁸⁾



4-Pin SOT-143 (U)

Note:

8. Package information is correct as of the publication date. For updates and most current information, go to www.micrel.com.

MICREL, INC. 2180 FORTUNE DRIVE SAN JOSE, CA 95131 USA
TEL +1 (408) 944-0800 FAX +1 (408) 474-1000 WEB <http://www.micrel.com>

Micrel, Inc. is a leading global manufacturer of IC solutions for the worldwide high performance linear and power, LAN, and timing & communications markets. The Company's products include advanced mixed-signal, analog & power semiconductors; high-performance communication, clock management, MEMs-based clock oscillators & crystal-less clock generators, Ethernet switches, and physical layer transceiver ICs. Company customers include leading manufacturers of enterprise, consumer, industrial, mobile, telecommunications, automotive, and computer products. Corporation headquarters and state-of-the-art wafer fabrication facilities are located in San Jose, CA, with regional sales and support offices and advanced technology design centers situated throughout the Americas, Europe, and Asia. Additionally, the Company maintains an extensive network of distributors and reps worldwide.

Micrel makes no representations or warranties with respect to the accuracy or completeness of the information furnished in this datasheet. This information is not intended as a warranty and Micrel does not assume responsibility for its use. Micrel reserves the right to change circuitry, specifications and descriptions at any time without notice. No license, whether express, implied, arising by estoppel or otherwise, to any intellectual property rights is granted by this document. Except as provided in Micrel's terms and conditions of sale for such products, Micrel assumes no liability whatsoever, and Micrel disclaims any express or implied warranty relating to the sale and/or use of Micrel products including liability or warranties relating to fitness for a particular purpose, merchantability, or infringement of any patent, copyright, or other intellectual property right.

Micrel Products are not designed or authorized for use as components in life support appliances, devices or systems where malfunction of a product can reasonably be expected to result in personal injury. Life support devices or systems are devices or systems that (a) are intended for surgical implant into the body or (b) support or sustain life, and whose failure to perform can be reasonably expected to result in a significant injury to the user. A Purchaser's use or sale of Micrel Products for use in life support appliances, devices or systems is a Purchaser's own risk and Purchaser agrees to fully indemnify Micrel for any damages resulting from such use or sale.

© 2005 Micrel, Incorporated.

Looking for pricing, stock, or lifecycle information?

Click below to explore more details on WIN SOURCE:

- ⊖ [View MIC6315-41D2UY-TR on WIN SOURCE](#)
- ⊖ [Microchip Technology](#) Information

Optimize Your Supply Chain with WIN SOURCE Solutions

- ✓ Global Sourcing Solution
- ✓ Obsolete Management
- ✓ Cost Control Management
- ✓ Shortage Management
- ✓ Alternative Solution
- ✓ Excess Inventory Management