

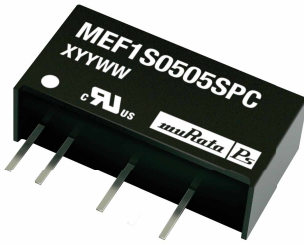

**THE DATASHEET OF
MEF1S1205SP3C**





FEATURES

- UL60950 recognised
- Short circuit protection
- Operation to zero load
- Output regulation <1%
- Single isolated output
- 1kVDC or 3.5kVDC isolation options 'Hi Pot Test'
- 3.3V, 5V, 12V & 24V input
- 3.3V & 5V output
- SMD construction
- Fully encapsulated with toroidal magnetics

DESCRIPTION

The MEF1 series of DC/DC converters is used where a tightly regulated supply is required. They are ideal for situations where the input voltage is not tightly controlled. The single rail regulated output makes the ideal choice to power sensors, such as pressure transducers, hall effect sensors and mass airflow sensors.

SELECTION GUIDE

Order Code	Nominal Input Voltage	Output Voltage	Output Current	Ripple & Noise (Typ.)	Ripple & Noise (Max.)	Input Current (Typ.)	Efficiency (Min.)	Efficiency (Typ.)	Isolation Capacitance	MTTF ¹
	V	V	mA	mVp-p	mVp-p	mA	%	%	pF	kHrs
MEF1S0303SPC	3.3	3.3	303	11	35	460	63	66	40	495
MEF1S0305SPC	3.3	5	200	9	35	430	68	71	30	867
MEF1S0503SPC	5	3.3	303	8	30	290	65	68.5	40	665
MEF1S0505SPC	5	5	200	10	40	275	69	73	50	1051
MEF1S1203SPC	12	3.3	303	11	35	120	65	69	40	511
MEF1S1205SPC	12	5	200	10	35	115	69	73.5	60	1044
MEF1S2403SPC	24	3.3	303	13	40	60	64	69	35	580
MEF1S2405SPC	24	5	200	13	40	55	68	73	45	834
3.5kVDC Isolation Part Numbers										
MEF1S0303SP3C	3.3	3.3	303	11	35	460	63	66	40	495
MEF1S0305SP3C	3.3	5	200	9	35	430	68	71	30	867
MEF1S0503SP3C	5	3.3	303	8	30	290	65	68.5	40	665
MEF1S0505SP3C	5	5	200	10	40	275	69	73	50	1051
MEF1S1203SP3C	12	3.3	303	11	35	120	65	69	40	511
MEF1S1205SP3C	12	5	200	10	35	115	69	73.5	60	1044
MEF1S2403SP3C	24	3.3	303	13	40	60	64	69	35	580
MEF1S2405SP3C	24	5	200	13	40	55	68	73	45	834

INPUT CHARACTERISTICS

Parameter	Conditions	Min.	Typ.	Max.	Units
Voltage range	Continuous operation, 3.3V input types	3.135	3.3	3.465	V
	Continuous operation, 5V input types	4.75	5	5.25	
	Continuous operation, 12V input types	11.4	12	12.6	
	Continuous operation, 24V input types	22.8	24	25.2	
Reflected ripple current			5	20	mA p-p

OUTPUT CHARACTERISTICS

Parameter	Conditions	Min.	Typ.	Max.	Units
Voltage set point accuracy	3.3V Output			± 2.5	%
	5V Output			± 2	
Rated power	T _A = -40°C to 85°C			1	W
Line regulation	High V _{IN} to low V _{IN}			0.25	%/%
Load regulation	10% load to rated load		0.3	1	%

ABSOLUTE MAXIMUM RATINGS

Short-circuit protection	Continuous
Lead temperature 1.5mm from case for 10 seconds	260°C
Input voltage V _{IN} , MEF1S03 types	4V
Input voltage V _{IN} , MEF1S05 types	7V
Input voltage V _{IN} , MEF1S12 types	18V
Input voltage V _{IN} , MEF1S24 types	28V

1. Calculated using MIL-HDBK-217F with nominal input voltage at full load.

All specifications typical at T_A=25°C, nominal input voltage and rated output current unless otherwise specified.



For full details go to
www.murata-ps.com/rohs



ISOLATION CHARACTERISTICS					
Parameter	Conditions	Min.	Typ.	Max.	Units
Isolation test voltage	SPC Versions Flash tested for 1 second	1000			VDC
	SP3C Versions Flash tested for 1 minute	3500			
Resistance	Viso= 1kVDC	10			GΩ

GENERAL CHARACTERISTICS					
Parameter	Conditions	Min.	Typ.	Max.	Units
Switching frequency	0303		45		kHz
	5V input types		50		
	12V input types & 0305		60		
	24V input types		75		

TEMPERATURE CHARACTERISTICS					
Parameter	Conditions	Min.	Typ.	Max.	Units
Specification	All output types	-40		85	°C
Case temperature above ambient				40	
Storage		-50		125	
Cooling	Free air convection				

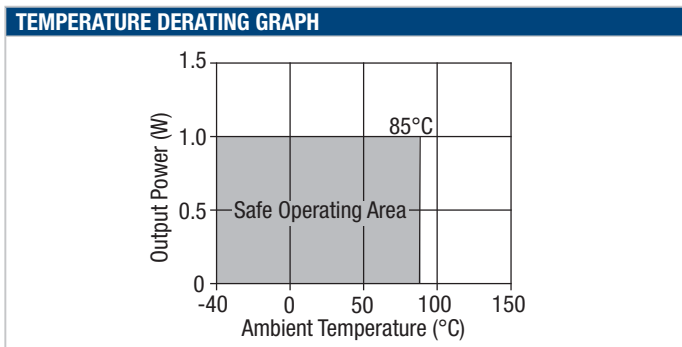

RoHS COMPLIANCE INFORMATION



This series is compatible with RoHS soldering systems with a peak wave solder temperature of 260°C for 10 seconds. The pin termination finish on the SIP package type is Tin Plate, Hot Dipped over Matte Tin over Nickel Preplate. This series is backward compatible with Sn/Pb soldering systems.

For further information, please visit www.murata-ps.com/rohs

EFFICIENCY VS LOAD

3.3V Input

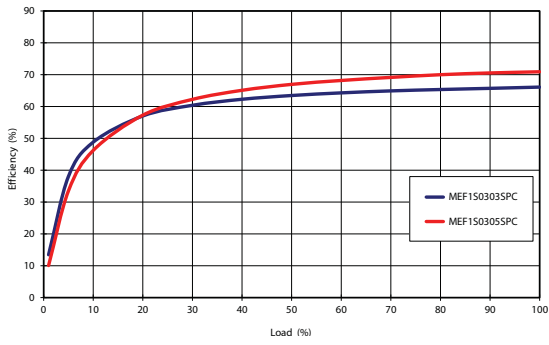

5V Input

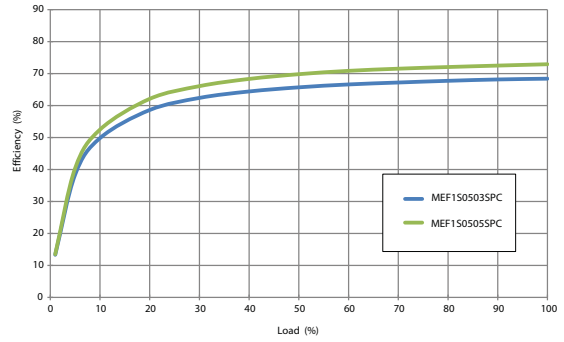

12V Input

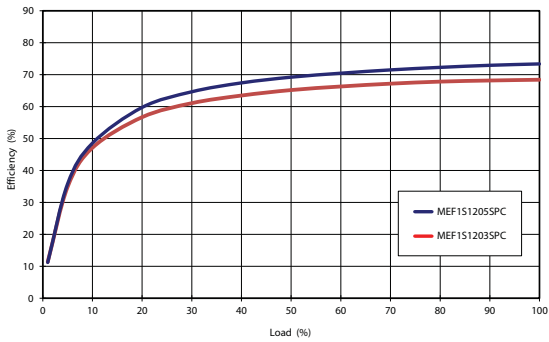

24V Input

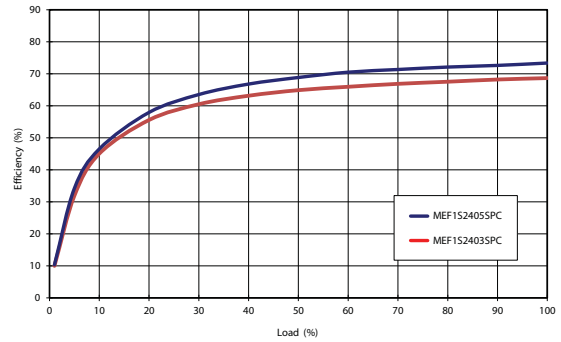

APPLICATION NOTES

Capacitive loading and start up

Typical start up times for this series, with a typical input voltage rise time of 2.2µs and output capacitance of 10µF, are shown in the table below. The product series will start into a capacitance of 47µF with an increased start time, however, the maximum recommended output capacitance is 10µF.

	Start-up time µs
MEF1S0303SPC	310
MEF1S0305SPC	550
MEF1S0503SPC	225
MEF1S0505SPC	460
MEF1S1203SPC	185
MEF1S1205SPC	390
MEF1S2403SPC	160
MEF1S2405SPC	430
MEF1S0303SP3C	310
MEF1S0305SP3C	550
MEF1S0503SP3C	225
MEF1S0505SP3C	460
MEF1S1203SP3C	185
MEF1S1205SP3C	390
MEF1S2403SP3C	160
MEF1S2405SP3C	430

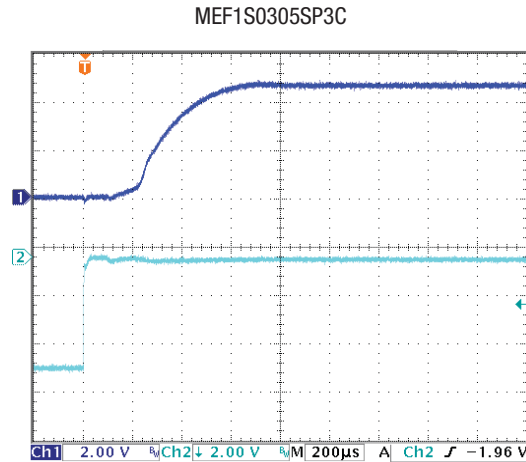

Ripple & Noise Characterisation Method

Ripple and noise measurements are performed with the following test configuration.

C1	1µF X7R multilayer ceramic capacitor, voltage rating to be a minimum of 3 times the output voltage of the DC/DC converter
C2	10µF tantalum capacitor, voltage rating to be a minimum of 1.5 times the output voltage of the DC/DC converter with an ESR of less than 100mΩ at 100 kHz
C3	100nF multilayer ceramic capacitor, general purpose
R1	450Ω resistor, carbon film, ±1% tolerance
R2	50Ω BNC termination
T1	3T of the coax cable through a ferrite toroid
RLOAD	Resistive load to the maximum power rating of the DC/DC converter. Connections should be made via twisted wires

Measured values are multiplied by 10 to obtain the specified values.

Differential Mode Noise Test Schematic

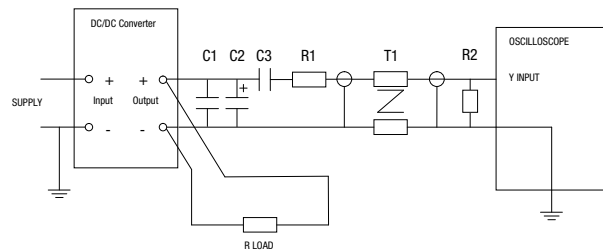

TECHNICAL NOTES**ISOLATION VOLTAGE**

'Hi Pot Test', 'Flash Tested', 'Withstand Voltage', 'Proof Voltage', 'Dielectric Withstand Voltage' & 'Isolation Test Voltage' are all terms that relate to the same thing, a test voltage, applied for a specified time, across a component designed to provide electrical isolation, to verify the integrity of that isolation.

Murata Power Solutions MEF1 series of DC/DC converters are all 100% production tested at their stated isolation voltage. This is 1kVDC for 1 second for SPC versions and 3.5kVDC for 1 minute for SP3C versions.

A question commonly asked is, "What is the continuous voltage that can be applied across the part in normal operation?"

The MEF1 has been recognised by Underwriters Laboratory for functional insulation, both input and output should normally be maintained within SELV limits i.e. less than 42.4V peak, or 60VDC. The isolation test voltage represents a measure of immunity to transient voltages and the part should never be used as an element of a safety isolation system.

The part could be expected to function correctly with several hundred volts offset applied continuously across the isolation barrier; but then the circuitry on both sides of the barrier must be regarded as operating at an unsafe voltage and further isolation/insulation systems must form a barrier between these circuits and any user-accessible circuitry according to safety standard requirements.

REPEATED HIGH-VOLTAGE ISOLATION TESTING

It is well known that repeated high-voltage isolation testing of a barrier component can actually degrade isolation capability, to a lesser or greater degree depending on materials, construction and environment. The MEF1 series has toroidal isolation transformers, with no additional insulation between primary and secondary windings of enameled wire. While parts can be expected to withstand several times the stated test voltage, the isolation capability does depend on the wire insulation. Any material, including this enamel (typically polyurethane) is susceptible to eventual chemical degradation when subject to very high applied voltages thus implying that the number of tests should be strictly limited. We therefore strongly advise against repeated high voltage isolation testing, but if it is absolutely required, that the voltage be reduced by 20% from specified test voltage.

This consideration equally applies to agency recognised parts rated for better than functional isolation where the wire enamel insulation is always supplemented by a further insulation system of physical spacing or barriers.

SAFETY APPROVAL

The MEF1 series has been recognised by Underwriters Laboratory (UL) to UL 60950 for functional insulation, file number E151252 applies. The MEF1 Series of converters are not internally fused so to meet the requirements of UL 60950 an anti-surge input line fuse should always be used with ratings as defined below.

MEF1S03xxx: 600mA

MEF1S05xxx: 400mA

MEF1S12xxx: 160mA

MEF1S24xxx: 100mA

All fuses should be UL approved and rated to at least the maximum allowable DC input voltage.

PACKAGE SPECIFICATIONS

MECHANICAL DIMENSIONS

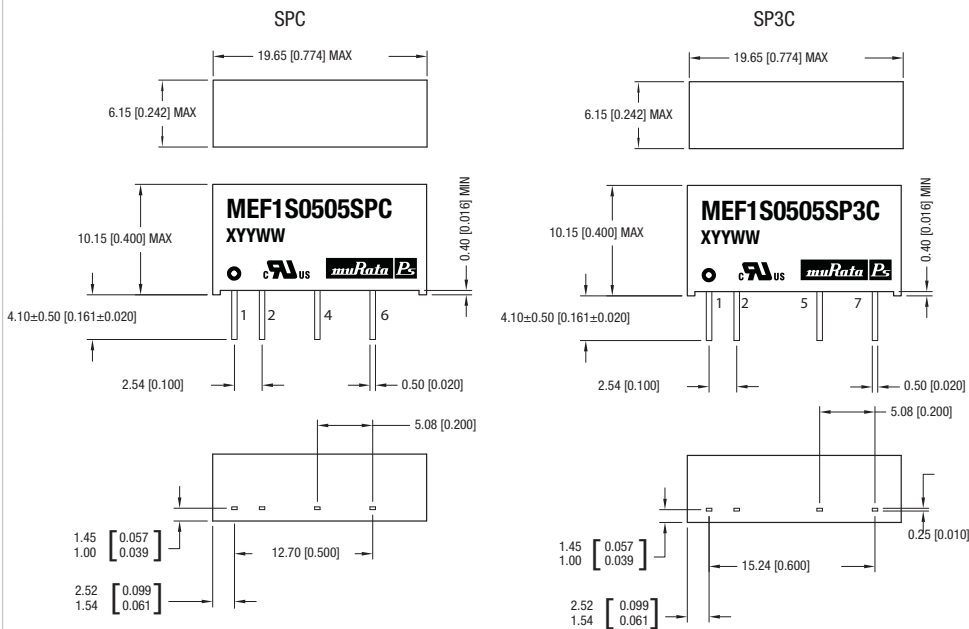

Unless otherwise stated all dimensions in mm (inches) ±0.05mm (0.002"). Controlling dimension is mm.
All pins on a 2.54mm (0.100") pitch and within 0.25mm (0.010") of true position.

Weight: 1.6g

PIN CONNECTIONS - SPC

Pin	Function
1	+VIN
2	-VIN
4	-VOUT
6	+VOUT

PIN CONNECTIONS - SP3C

Pin	Function
1	+VIN
2	-VIN
5	-VOUT
7	+VOUT

PACKAGE SPECIFICATIONS (continued)

RECOMMENDED FOOTPRINT DETAILS

SPC

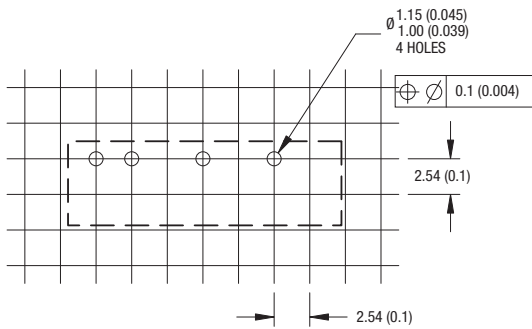

SP3C

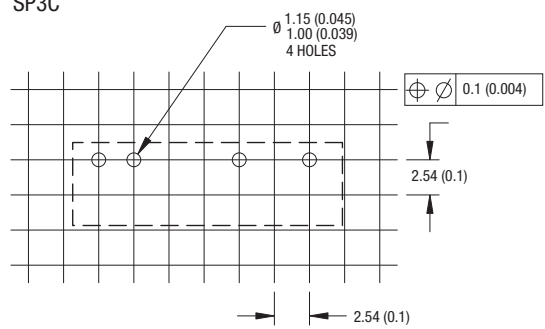

All dimensions in mm ±0.25mm (inches ±0.01).

TUBE OUTLINE DIMENSIONS

7 Pin SIP Tube

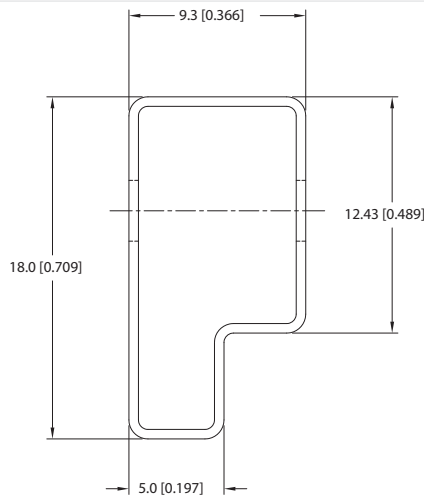

Unless otherwise specified all dimensions in mm [inches] ±0.55mm [0.022].
Tube Length : 520mm [20.472] ±2.0 [0.079].

Tube Quantity : 25

Murata Power Solutions, Inc.
11 Cabot Boulevard, Mansfield, MA 02048-1151 U.S.A.
ISO 9001 and 14001 REGISTERED





This product is subject to the following **operating requirements** and the **Life and Safety Critical Application Sales Policy**:
Refer to: <http://www.murata-ps.com/requirements/>

Murata Power Solutions, Inc. makes no representation that the use of its products in the circuits described herein, or the use of other technical information contained herein, will not infringe upon existing or future patent rights. The descriptions contained herein do not imply the granting of licenses to make, use, or sell equipment constructed in accordance therewith. Specifications are subject to change without notice.
© 2017 Murata Power Solutions, Inc.

Looking for pricing, stock, or lifecycle information?

Click below to explore more details on WIN SOURCE:

-  [View MEF1S1205SP3C on WIN SOURCE](#)
-  [Murata Power Solutions Inc. Information](#)

Optimize Your Supply Chain with WIN SOURCE Solutions

-  Global Sourcing Solution
-  Obsolete Management
-  Cost Control Management
-  Shortage Management
-  Alternative Solution
-  Excess Inventory Management