



**THE DATASHEET OF  
HMC665LP4E**



# HMC665LP4 / 665LP4E

## GaAs MMIC MIXER w/ INTEGRATED IF & LO AMPLIFIER, 0.7 - 1.2 GHz

### Typical Applications

The HMC665LP4 / HMC665LP4E is ideal for:

- Cellular/3G & WiMAX/LTE/4G Infrastructure
- Base Stations & Repeaters
- Broadband & Fixed Wireless
- Access Points
- Test & Measurement Equipment

### Features

- High Input IP3: +23 dBm
- Low Input LO Drive: -3 to +6 dBm
- High LO to RF Isolation: 36 dB
- High Conversion Gain: 10 dB
- Ideal for Upconversion or Downconversion
- 24 Lead 4x4mm SMT Package: 16mm<sup>2</sup>

### Functional Diagram

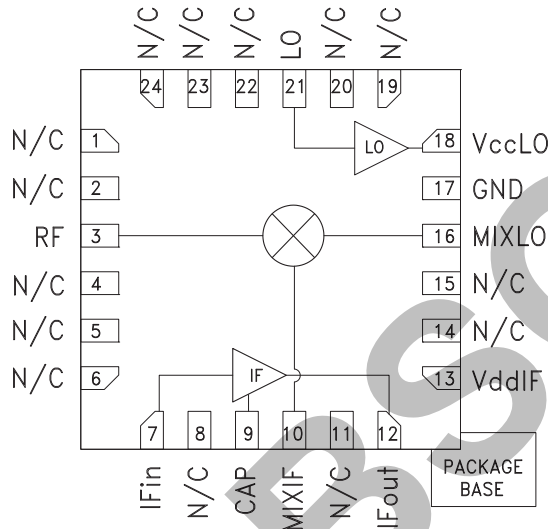

### General Description

The HMC665LP4E is a highly integrated converter IC that operates from 0.7 to 1.2 GHz for both up-conversion and downconversion applications. The HMC665LP4E incorporates a high dynamic range, passive double-balanced mixer core with integrated LO and IF amplifiers, making it ideal for compact transceiver applications in GSM, WCDMA, TD-SCDMA, WiBro and WiMAX. This versatile converter RFIC operates with a low LO input power level of only -3 dBm, provides up to 10 dB conversion gain, and exhibits +23 dBm Input IP3 in downconversion mode. This RFIC provides up to 11 dB conversion gain in upconverter mode. Specific evaluation boards are available for both upconverter and downconverter modes.

### Electrical Specifications, $T_A = +25^\circ \text{C}$ , LO = 0 dBm, VccLO = VddIF = +5V

Parameter	Min.	Typ.	Max.	Units
Frequency Range, RF, LO	0.7 - 1.2			GHz
Frequency Range, IF	250 - 450			MHz
Conversion Gain	7	10		dB
Noise Figure (SSB)		10		dB
LO to RF Isolation	32	36		dB
LO to IF Isolation		1		dB
IP3 (Input)		23		dBm
1 dB Compression (Input)		10		dBm
LO Drive Input Level (Typical)	-3 to +6			dBm
Supply Current (I <sub>ddIF</sub> + I <sub>ccLO</sub> )		150	200	mA

\*Unless otherwise noted, all measurements performed as a downconverter and configured as shown in the downconverter mode application circuit, IF=250 MHz



## GaAs MMIC MIXER w/ INTEGRATED IF & LO AMPLIFIER, 0.7 - 1.2 GHz

### Downconversion Plots

Conversion Gain vs. LO Drive, IF = 250 MHz

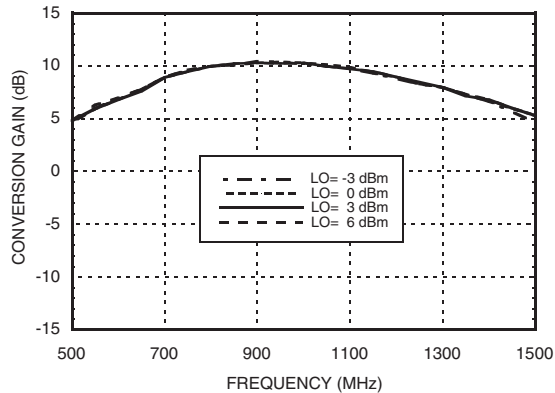

Conversion Gain vs. LO Drive, IF = 450 MHz

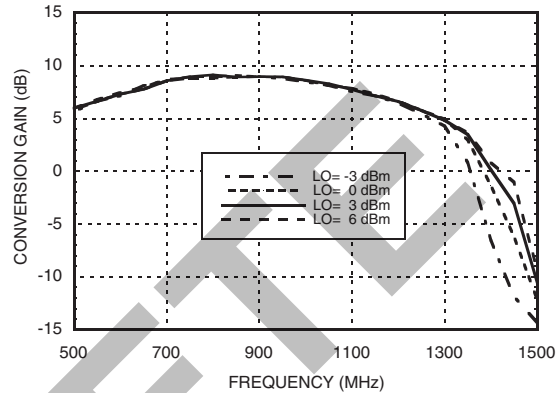

Conversion Gain vs. Temperature, IF = 250 MHz

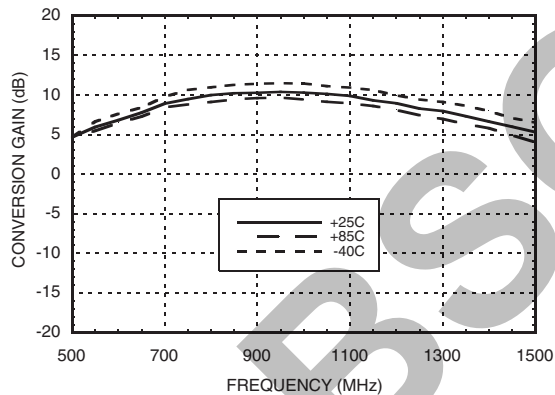

Conversion Gain vs. Temperature, IF = 450 MHz

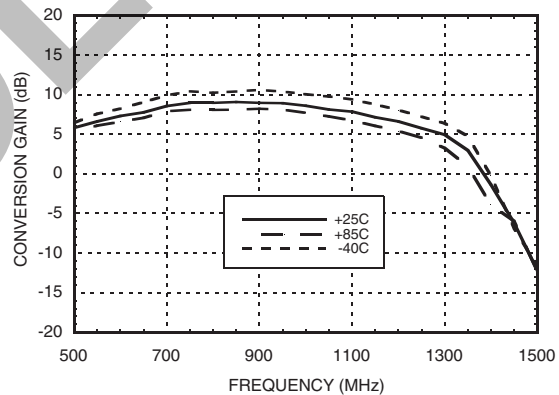

Input IP2 vs. LO Drive, IF = 450 MHz

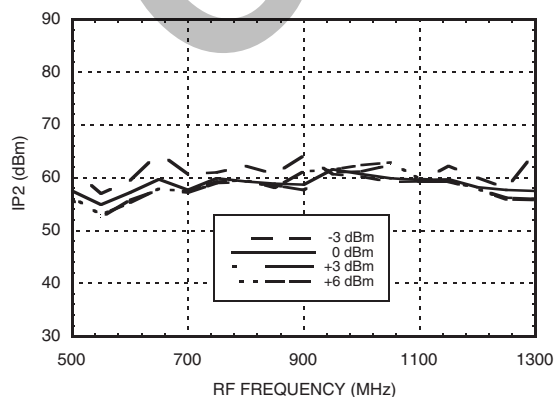

Input IP2 vs. Temperature, IF = 450 MHz

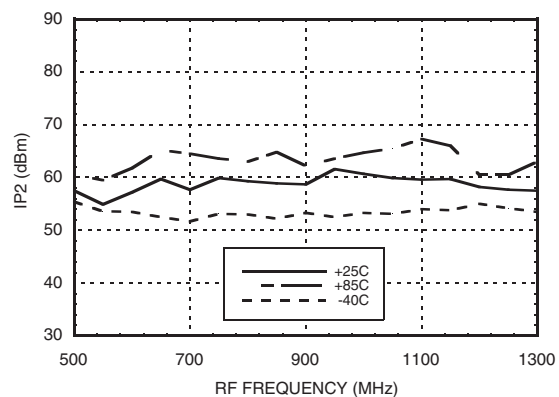

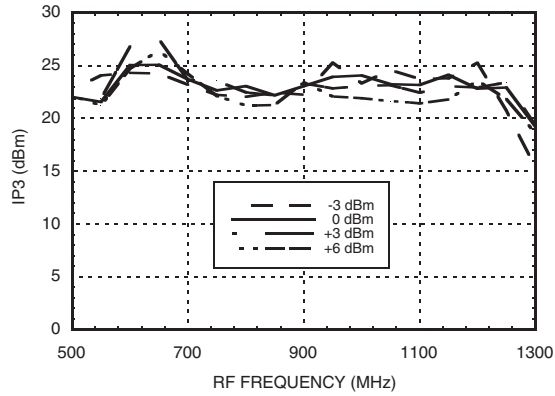
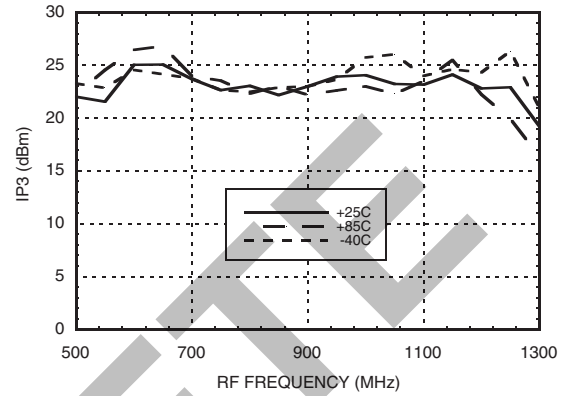
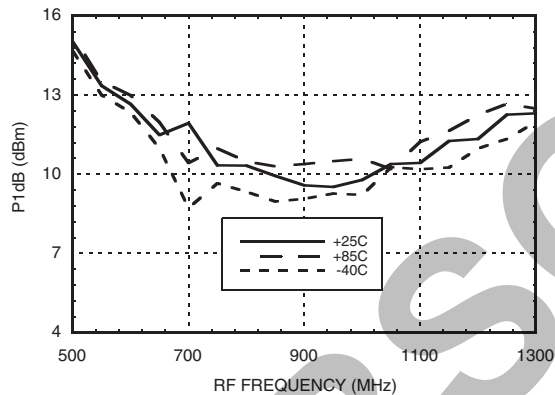
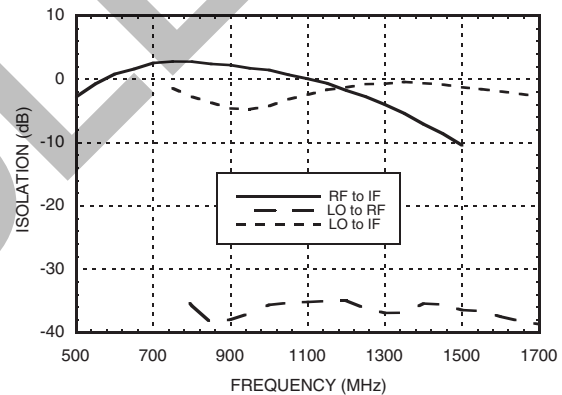
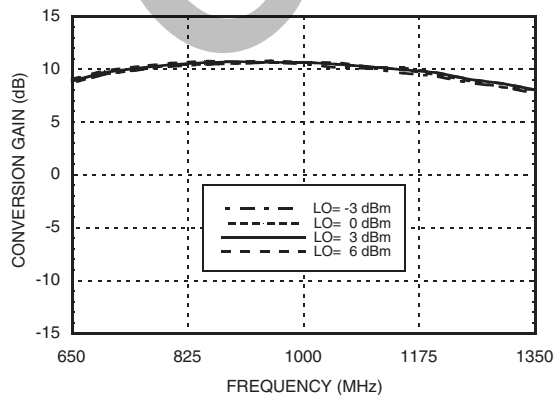
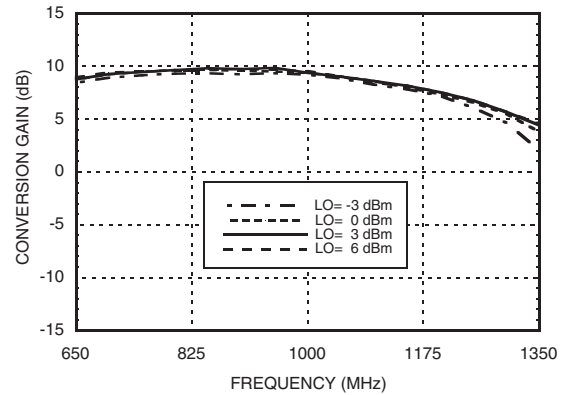
**Downconversion Plots**
**Input IP3 vs. LO Drive, IF = 450 MHz**

**Input IP3 vs. Temperature, IF = 450 MHz**

**Input P1dB vs. Temperature, IF = 350 MHz**

**Isolation vs. Frequency**

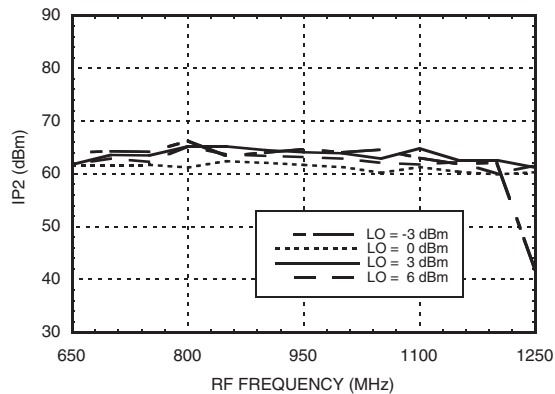
**Upconversion Plots**
**Conversion Gain vs.  
LO Drive, IF = 250 MHz**

**Conversion Gain vs.  
LO Drive, IF = 450 MHz**



## GaAs MMIC MIXER w/ INTEGRATED IF & LO AMPLIFIER, 0.7 - 1.2 GHz

**Input IP2 vs. LO Drive, IF = 450 MHz**



**Input IP3 vs. LO Drive, IF = 450 MHz**

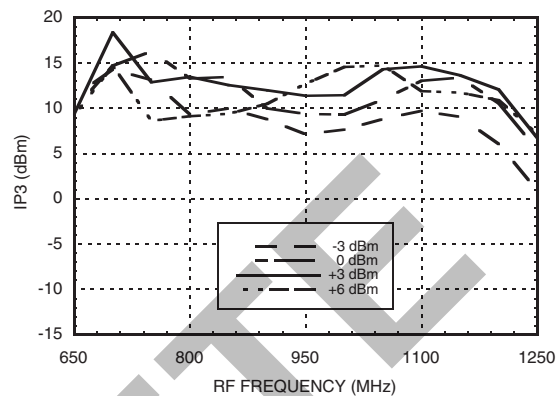

**IF Bandwidth**

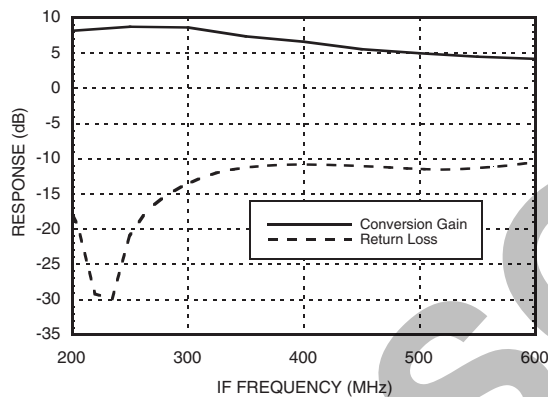

**Return Loss**

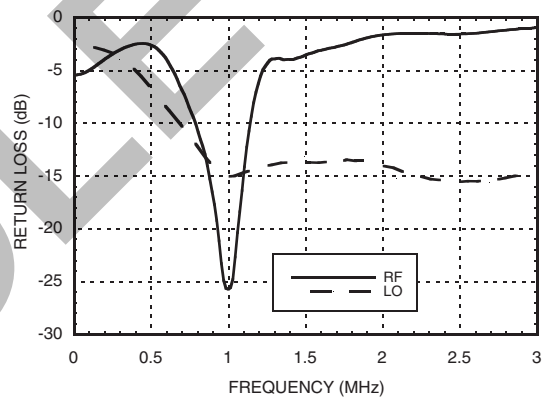

**MxN Spurious @ IF Port**

mRF	nLO				
	0	1	2	3	4
0	xx	3	21	29	58
1	7	0	33	52	59
2	66	56	50	65	84
3	91	84	73	77	91
4	91	91	91	91	91

All values in dBc below IF power level (1RF - 1LO)

**Harmonics of LO**

LO Freq. (GHz)	nLO Spur at RF Port			
	1	2	3	4
0.5	31	32	32	39
0.6	28	23	32	47
0.7	30	21	30	44
0.8	37	21	32	47
0.9	38	23	37	53
1.0	35	24	40	43
1.2	34	27	33	55
1.4	35	32	33	58
1.6	36	38	46	62.6

LO = 0 dBm  
Values in dBc below input LO level measured at RF port.

**Absolute Maximum Ratings**

RF / MIX IF Input (VddIF = +5V)	+22 dBm
LO Input (VccLO = +5V)	+10 dBm
IFIN	+15 dBm
VccLO	+7 Vdc
VddIF	+8 Vdc
Junction Temperature	150 °C
Continuous Pdiss (T = 85°C) (derate 14.9 mW/°C above 85°C)	0.97 W
Thermal Resistance (junction to ground paddle)	67.2 °C/W
Storage Temperature	-65 to +150°C
Operating Temperature	-40 to +85°C

**Typical Supply Current**

VddIF + VccLO	IddIF + IccLO
+4.5	130 mA
+5.0	150 mA
+5.5	165 mA

### Typical Performance Cascade Analysis HMC665LP4E Downconverter Mode (RF Input = 700 to 1200 MHz, IF Output = 250 to 450 MHz, LO = Low Side or High Side)

Description	Component Level					Cumulative MCM Performance					
	Gain (dB)	NF (dB)	OIP3 (dBm)	OP1dB (dBm)	+5V Current (mA)	Gain (dB)	NF (dB)	OIP3 (dBm)	IIP3 (dBm)	OP1dB (dBm)	IP1dB (dBm)
Mixer w/ LO Amplifier	-8.0	8.5	15.0	7.0	57.0	-8.0	8.5	15.0	23.0	7.0	16.0
IF Amplifier	18.0	1.0	37.5	21.0	93.0	10.0	9.4	31.7	21.7	19.5	10.5
HMC665LP4E	Cumulative MCM Performance				150.0	10.0	9.4	31.7	21.7	19.5	10.5

\* RF image rejection filter is not included in the released eval boards.

### Typical Performance Cascade Analysis HMC665LP4E Upconverter Mode (RF Output = 700 to 1200 MHz, IF Input = 250 to 450 MHz, LO = Low Side or High Side)

Description	Component Level					Cumulative MCM Performance					
	Gain (dB)	NF (dB)	OIP3 (dBm)	OP1dB (dBm)	+5V Current (mA)	Gain (dB)	NF (dB)	OIP3 (dBm)	IIP3 (dBm)	OP1dB (dBm)	IP1dB (dBm)
IF Amplifier	18.0	1.0	38	21.0	93.0	18.0	1.0	38	20	21.0	4.0
Mixer w/ LO Amplifier	-7.5	8.5	21	7.0	57.0	10.0	1.3	20.5	10	7.0	-3.0
HMC665LP4E	Cumulative MCM Performance				150.0	10.0	1.3	20.5	10	7.0	-3.0

\* IF image rejection filter is not included in the released eval boards.



ELECTROSTATIC SENSITIVE DEVICE  
OBSERVE HANDLING PRECAUTIONS

### Outline Drawing

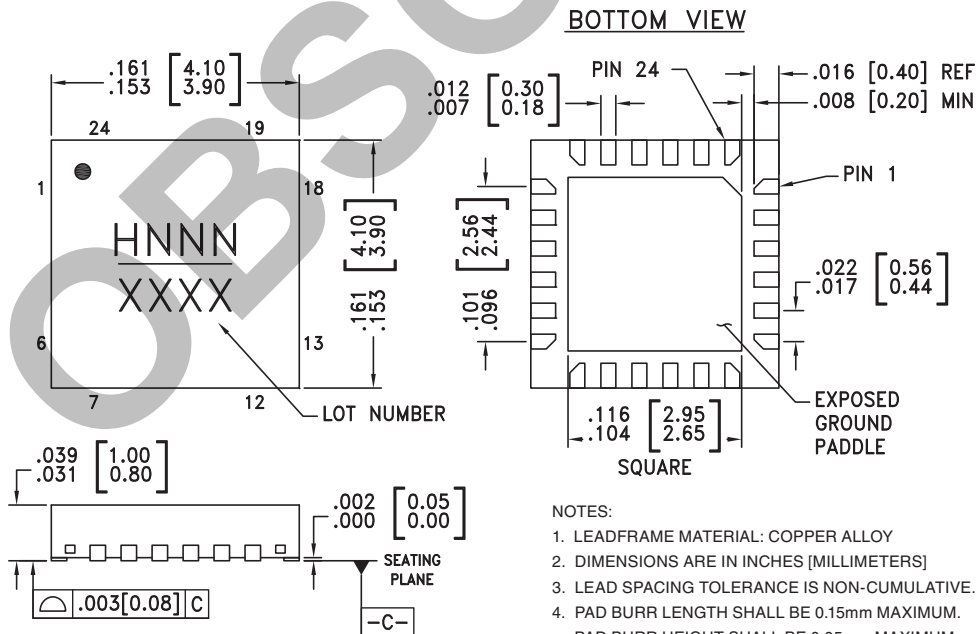

- NOTES:
1. LEADFRAME MATERIAL: COPPER ALLOY
  2. DIMENSIONS ARE IN INCHES [MILLIMETERS]
  3. LEAD SPACING TOLERANCE IS NON-CUMULATIVE.
  4. PAD BURR LENGTH SHALL BE 0.15mm MAXIMUM. PAD BURR HEIGHT SHALL BE 0.05mm MAXIMUM.
  5. PACKAGE WARP SHALL NOT EXCEED 0.05mm.
  6. ALL GROUND LEADS AND GROUND PADDLE MUST BE SOLDERED TO PCB RF GROUND.
  7. REFER TO HITTITE APPLICATION NOTE FOR SUGGESTED LAND PATTERN.



### Package Information

Part Number	Package Body Material	Lead Finish	MSL Rating	Package Marking <sup>[3]</sup>
HMC665LP4	Low Stress Injection Molded Plastic	Sn/Pb Solder	MSL1 <sup>[1]</sup>	H665 XXXX
HMC665LP4E	RoHS-compliant Low Stress Injection Molded Plastic	100% matte Sn	MSL1 <sup>[2]</sup>	H665 XXXX

[1] Max peak reflow temperature of 235 °C

[2] Max peak reflow temperature of 260 °C

[3] 4-Digit lot number XXXX

### Pin Descriptions

Pin Number	Function	Description	Interface Schematic
1, 2, 4, 5, 6, 8, 11, 14, 15, 19, 20, 22 - 24	N/C	No connection. These pins may be connected to RF ground. Performance will not be affected.	
3	RF	This pin is DC coupled and matched to 50 Ohms.	
7	IFIN	This pin is matched to 50 Ohms with a 56nH inductor to ground. See Application Circuit.	
9	CAP	AC ground. An external capacitor of 0.01 µF to ground is required for low frequency bypassing. See application circuit for further details.	
10	MIXIF	This pin is DC coupled. For applications not requiring operation to DC, this port should be DC blocked externally using a series capacitor whose value has been chosen to pass the necessary IF frequency range. For operation to DC, this pin must not source/sink more than 18 mA of current or part non-function and possible part failure will result.	
12	IFOUT	This pin is AC coupled and matched to 50 Ohms.	
13	VddIF	Power supply for IF amplifier. Choke inductor and bypass capacitor are required. See application circuit.	
16	MIXLO	This pin is DC coupled and matched to 50 Ohms. An off chip DC blocking capacitor is required.	
17	GND	Backside of package has exposed metal ground paddle that must also be connected to ground.	
18	VccLO	Power supply and RF Output of the LO amplifier. Three external bypass capacitors are recommended for optimum performance, as illustrated in the application circuit.	

### Pin Descriptions (Continued)

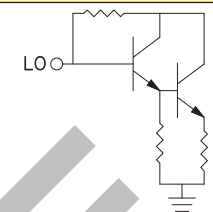
Pin Number	Function	Description	Interface Schematic
21	LO	This pin is DC coupled and matched to 50 Ohms. An off chip DC blocking capacitor is required. See application circuit.	

### Evaluation PCB - Upconverter Mode

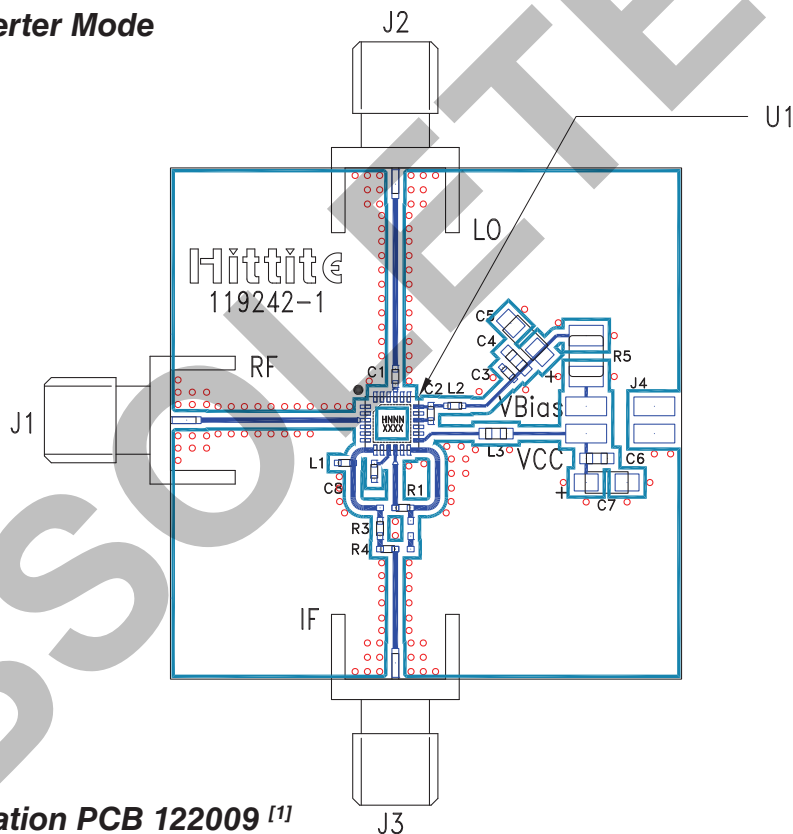

### List of Materials for Evaluation PCB 122009 [1]

Item	Description
J1 - J3	PCB Mount SMA RF Connector
J4	2mm DC Header
C1, C2, C3	100 pF Chip Capacitor, 0402 Pkg.
C4, C6	1000 pF Chip Capacitor, 0603 Pkg.
C5, C7	2.2 μF Capacitor, Tantalum
C8	0.01 μF Chip Capacitor, 0402 Pkg.
L1, L2	56 nH Chip Inductor, 0402 Pkg.
L3	36 nH Chip Inductor, 0603 Pkg.
R1, R3, R4	0 Ohm Resistor, 0402 Pkg.
R5	24 Ohm Resistor, 1210 Pkg.
U1	HMC665LP4(E) - Mixer
PCB [2]	119242 Evaluation Board

[1] Reference this number when ordering complete evaluation PCB

[2] Circuit Board Material: Arlon 25FR

The circuit board used in the application should use RF circuit design techniques. Signal lines should have 50 Ohm impedance while the package ground leads and exposed paddle should be connected directly to the ground plane similar to that shown. A sufficient number of via holes should be used to connect the top and bottom ground planes. The evaluation circuit board shown is available from Hittite upon request.

### Evaluation PCB - Downconverter Mode

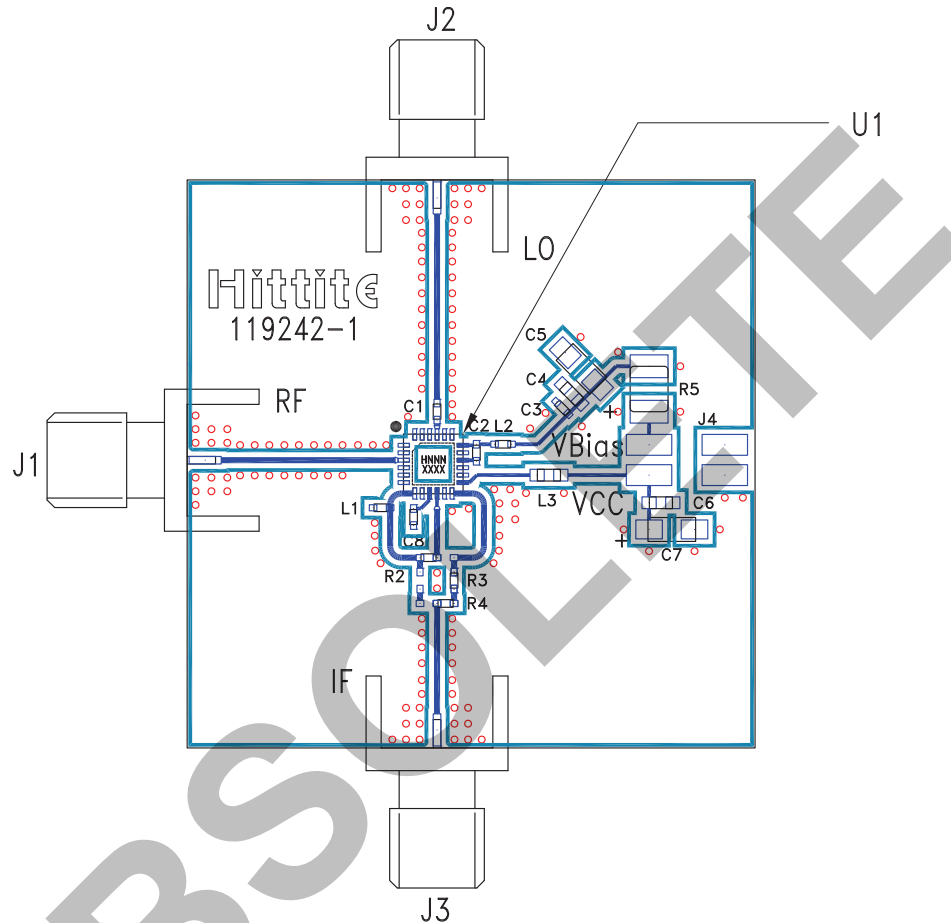

### List of Materials for Evaluation PCB 122010 [1]

Item	Description
J1 - J3	PCB Mount SMA RF Connector
J4	2mm DC Header
C1, C2, C3	100 pF Chip Capacitor, 0402 Pkg.
C4, C6	1000 pF Chip Capacitor, 0603 Pkg.
C5, C7	2.2 $\mu$ F Capacitor, Tantalum
C8	0.01 $\mu$ F Chip Capacitor, 0402 Pkg.
L1, L2	56 nH Chip Inductor, 0402 Pkg.
L3	36 nH Chip Inductor, 0603 Pkg.
R2, R3, R4	0 Ohm Resistor, 0402 Pkg.
R5	24 Ohm Resistor, 1210 Pkg.
U1	HMC665LP4(E) - Mixer
PCB [2]	119242 Evaluation Board

[1] Reference this number when ordering complete evaluation PCB

[2] Circuit Board Material: Arlon 25FR

The circuit board used in the application should use RF circuit design techniques. Signal lines should have 50 Ohm impedance while the package ground leads and exposed paddle should be connected directly to the ground plane similar to that shown. A sufficient number of via holes should be used to connect the top and bottom ground planes. The evaluation circuit board shown is available from Hittite upon request.

### Application Circuit - Upconverter Mode

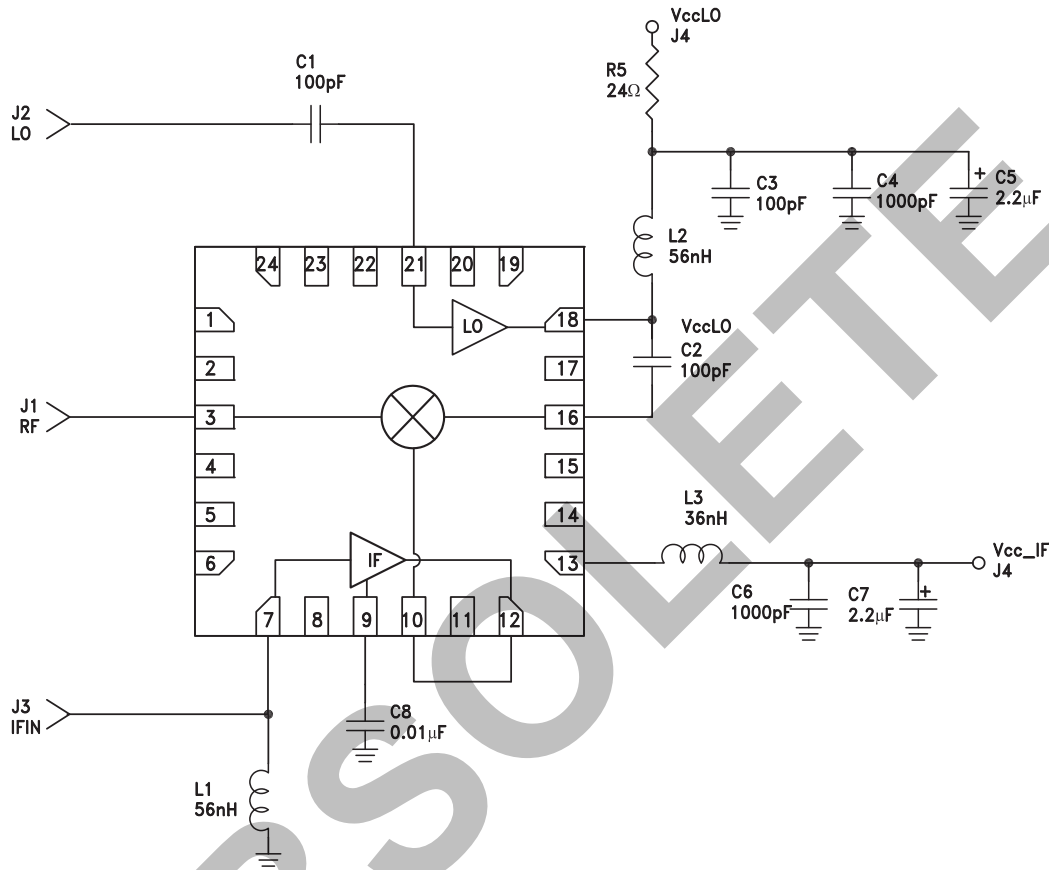

10

MIXERS - HIGH IP3 - SMT

### Application Circuit - Downconverter Mode

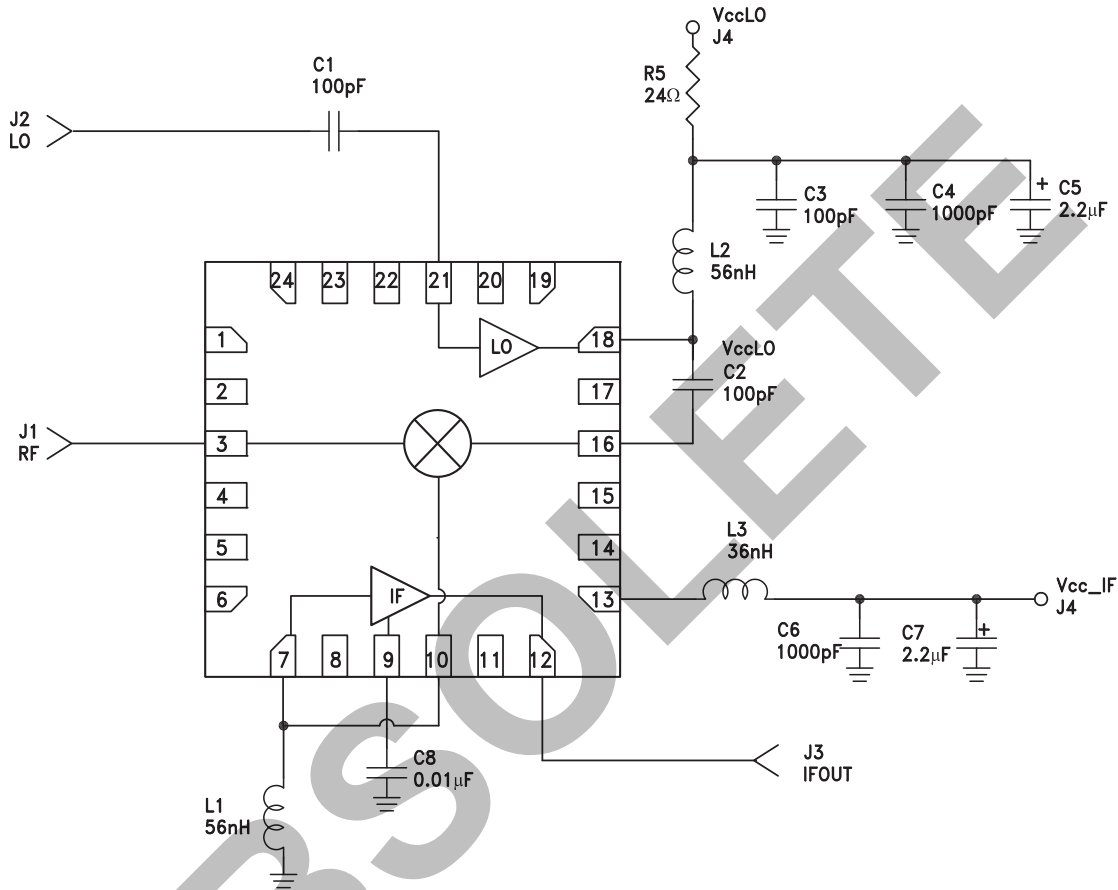

## Looking for pricing, stock, or lifecycle information?

Click below to explore more details on WIN SOURCE:

 [View HMC665LP4E on WIN SOURCE](#)

 [Analog Devices Inc. Information](#)

## Optimize Your Supply Chain with WIN SOURCE Solutions

-  Global Sourcing Solution
-  Obsolete Management
-  Cost Control Management
-  Shortage Management
-  Alternative Solution
-  Excess Inventory Management