



**THE DATASHEET OF  
MAX9716EUA+**



# Low-Cost, Mono, 1.4W BTL Audio Power Amplifiers

## General Description

The MAX9716/MAX9717 audio power amplifiers are ideal for portable audio devices with internal speakers. A bridge-tied load (BTL) architecture minimizes external component count, while providing high-quality audio reproduction. Both devices deliver 1.4W continuous power into a 4Ω load with less than 1% Total Harmonic Distortion (THD) while operating from a single +5V supply. With an 8Ω load, both devices deliver 1W continuous power. These devices also deliver 350mW continuous power into an 8Ω load while operating from a single +3.0V supply. The devices are available as adjustable gain amplifiers (MAX9716/MAX9717A) or with internally fixed gains of 6dB, 9dB, and 12dB (MAX9717B/MAX9717C/MAX9717D), reducing component count.

A low-power shutdown mode disables the bias generator and amplifiers, reducing quiescent current consumption to less than 10nA. These devices feature Maxim's industry-leading, comprehensive click-and-pop suppression that reduces audible clicks and pops during startup and shutdown.

The MAX9717 features a headphone sense input ( $\overline{\text{BTL/SE}}$ ) that senses when a headphone is connected to the device, disables the BTL slave driver, muting the speaker while driving the headphone as a single-ended load.

The MAX9716 is pin compatible with the LM4890 and is available in 9-bump UCSP™, 8-pin TDFN (3mm x 3mm), and 8-pin μMAX® packages. The MAX9717 is available in 9-bump UCSP, 8-pin TDFN, and 8-pin μMAX packages. Both devices operate over the -40°C to +85°C extended temperature range.

## Applications

Mobile Phones      Portable Devices  
PDAs

## Features

- ◆ 2.7V to 5.5V Single-Supply Operation
- ◆ 1.4W into 4Ω at 1% THD+N
- ◆ 10nA Low-Power Shutdown Mode
- ◆ 73dB PSRR at 1kHz
- ◆ No Audible Clicks or Pops at Power-Up/Down
- ◆ Internal Fixed Gain to Reduce Component Count (MAX9717B/C/D)
- ◆ Adjustable Gain Option (MAX9716/MAX9717A)
- ◆  $\overline{\text{BTL/SE}}$  Input Senses when Headphones are Connected (MAX9717)
- ◆ Pin Compatible with LM4890 (MAX9716)
- ◆ Pin Compatible with TPA711 (MAX9717A)
- ◆ Available in Compact, Thermally Enhanced μMAX and TDFN (3mm x 3mm) Packages

## Ordering Information

PART	TEMP RANGE	PIN-PACKAGE	GAIN (dB)
MAX9716ETA+T	-40°C to +85°C	8 TDFN-EP*	Adj.
MAX9716EBL+TG45	-40°C to +85°C	3 x 3 UCSP	Adj.
MAX9716EUA	-40°C to +85°C	8 μMAX-EP*	Adj.
MAX9716EUA/V+	-40°C to +85°C	8 μMAX-EP*	Adj.

\*EP = Exposed pad.

+Denotes a lead(Pb)-free/RoHS-compliant package.

G45 indicates protective die coating.

/V denotes automotive qualified part.

Ordering Information continued at end of data sheet.

Pin Configurations and Selector Guide appear at end of data sheet.

## Simplified Block Diagrams

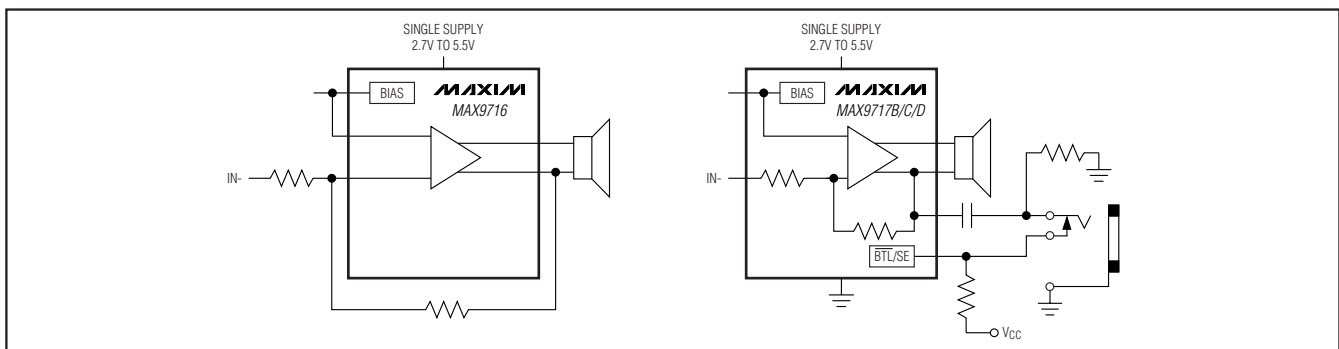

UCSP is a trademark of Maxim Integrated Products, Inc.  
μMAX is a registered trademark of Maxim Integrated Products, Inc.

# Low-Cost, Mono, 1.4W BTL Audio Power Amplifiers

## ABSOLUTE MAXIMUM RATINGS

Supply Voltage ( $V_{CC}$  to GND) .....-0.3V to +6V  
 Any Other Pin to GND .....-0.3V to ( $V_{CC} + 0.3V$ )  
 $\overline{IN}_-$ , BIAS,  $\overline{SHDN}$ ,  $\overline{BTL/SE}$  Continuous Current.....20mA  
 $\overline{OUT}_-$  Short-Circuit Duration to GND or  $V_{CC}$  (Note 1)...Continuous  
 Continuous Power Dissipation ( $T_A = +70^\circ\text{C}$ )  
   8-Pin TDFN (derate 24.4mW/ $^\circ\text{C}$  above  $+70^\circ\text{C}$ ) .....1951mW  
   8-Pin  $\mu\text{MAX}$  (derate 10.3mW/ $^\circ\text{C}$  above  $+70^\circ\text{C}$ ) .....825mW  
   9-Bump UCSP (derate 5.2mW/ $^\circ\text{C}$  above  $70^\circ\text{C}$ ).....412mW

Operating Temperature Range .....-40 $^\circ\text{C}$  to +85 $^\circ\text{C}$   
 Maximum Junction Temperature .....+150 $^\circ\text{C}$   
 Storage Temperature Range .....-65 $^\circ\text{C}$  to +150 $^\circ\text{C}$   
 Lead Temperature (soldering, 10s) .....+300 $^\circ\text{C}$   
 Soldering Temperature (reflow)  
   Lead(Pb)-Free Packages.....+260 $^\circ\text{C}$   
   Packages Containing Lead(Pb).....+240 $^\circ\text{C}$

Stresses beyond those listed under "Absolute Maximum Ratings" may cause permanent damage to the device. These are stress ratings only, and functional operation of the device at these or any other conditions beyond those indicated in the operational sections of the specifications is not implied. Exposure to absolute maximum rating conditions for extended periods may affect device reliability.

## ELECTRICAL CHARACTERISTICS—5V Supply

( $V_{CC} = 5V$ ,  $V_{GND} = 0V$ ,  $\overline{SHDN} = V_{CC}$ ,  $T_A = +25^\circ\text{C}$ .  $C_{BIAS} = 1\mu\text{F}$ ,  $R_{IN} = R_F = 20k\Omega$  (MAX9716/MAX9717A),  $\overline{IN}_+ = \text{BIAS}$  (MAX9716),  $\overline{BTL/SE} = \text{GND}$  (MAX9717 $_{-}$ ),  $R_L = \infty$  connected between  $\overline{OUT}_+$  and  $\overline{OUT}_-$ . Typical values are at  $T_A = +25^\circ\text{C}$ .) (Note 2)

PARAMETER	SYMBOL	CONDITIONS		MIN	TYP	MAX	UNITS
Supply Voltage	$V_{CC}$	Inferred by PSRR test		2.7		5.5	V
Quiescent Supply Current	$I_{CC}$	$V_{\overline{IN}_-} = V_{\overline{IN}_+} = V_{BIAS}$ (Note 3), $T_A = -40^\circ\text{C}$ to $+85^\circ\text{C}$			4.3	8	mA
Shutdown Supply Current	$I_{SHDN}$	$\overline{SHDN} = \text{GND}$			0.01	1	$\mu\text{A}$
$\overline{SHDN}$ Threshold	$V_{IH}$			1.2			V
	$V_{IL}$					0.4	
$\overline{BTL/SE}$ Threshold	$V_{IH}$			0.9 x $V_{CC}$			V
	$V_{IL}$					0.7 x $V_{CC}$	
Common-Mode Bias Voltage	$V_{BIAS}$	(Note 4)		$V_{CC}/2 - 6\%$	$V_{CC}/2$	$V_{CC}/2 + 6\%$	V
Output Offset Voltage	$V_{OS}$	$V_{\overline{IN}_-} = V_{\overline{OUT}_+}$ , $V_{\overline{IN}_+} = V_{BIAS}$ (Note 5)			$\pm 7$	$\pm 15$	mV
Power-Supply Rejection Ratio	PSRR	$V_{CC} = 2.7V$ to $5.5V$	DC, $V_{BIAS} = 1.5V$	60	80		dB
		$V_{\overline{IN}_+} = V_{BIAS}$ , $V_{RIPPLE} = 200\text{mV}_{P-P}$ , $R_L = 8\Omega$ (Note 6)	$f = 217\text{Hz}$		61		
			$f = 1\text{kHz}$			73	
Output Power	$P_{OUT}$	$R_L = 8\Omega$ , THD+N = 1%, $f_{IN} = 1\text{kHz}$ (Note 7)		0.8	1.1		W
		$R_L = 4\Omega$ , THD+N = 1%, $f_{IN} = 1\text{kHz}$ (Note 7)			1.4		
		$R_L = 16\Omega$ , $\overline{BTL/SE} = V_{CC}$ (single-ended mode), THD+N = 1%, $f_{IN} = 1\text{kHz}$			0.155		
Total Harmonic Distortion Plus Noise	THD+N	$A_V = 6\text{dB}$ , $R_L = 8\Omega$ , $f_{IN} = 1\text{kHz}$ , $P_{OUT} = 0.5W$ (Note 8)			0.024		%
Output Noise Density	$e_n$	$f_{IN} = 10\text{kHz}$			106		nV/ $\sqrt{\text{Hz}}$
Signal-to-Noise Ratio	SNR	THD+N = 1%			105		dB

# Low-Cost, Mono, 1.4W BTL Audio Power Amplifiers

MAX9716/MAX9717

## ELECTRICAL CHARACTERISTICS—5V Supply (continued)

( $V_{CC} = 5V$ ,  $V_{GND} = 0V$ ,  $\overline{SHDN} = V_{CC}$ ,  $T_A = +25^\circ C$ .  $C_{BIAS} = 1\mu F$ ,  $R_{IN} = R_F = 20k\Omega$  (MAX9716/MAX9717A),  $IN_+ = BIAS$  (MAX9716),  $BTL/SE = GND$  (MAX9717\_),  $R_L = \infty$  connected between  $OUT_+$  and  $OUT_-$ . Typical values are at  $T_A = +25^\circ C$ .) (Note 2)

PARAMETER	SYMBOL	CONDITIONS	MIN	TYP	MAX	UNITS
Output Short-Circuit Current Limit	$I_{SC}$	(Note 9)		1.1		A
Thermal Shutdown Threshold				+160		$^\circ C$
Thermal Shutdown Hysteresis				15		$^\circ C$
Power-Up/Enable from Shutdown Time (Note 10)	$t_{PU}$			250		ms
		$C_{BIAS} = 0.1\mu F$		25		
Shutdown Time	$t_{SHDN}$			5		$\mu s$
Input Resistance	$R_{IN}$	MAX9717B/C/D	12	20	28	$k\Omega$

## ELECTRICAL CHARACTERISTICS—3V Supply

( $V_{CC} = 3V$ ,  $V_{GND} = 0V$ ,  $\overline{SHDN} = V_{CC}$ ,  $T_A = +25^\circ C$ .  $C_{BIAS} = 1\mu F$ ,  $R_{IN} = R_F = 20k\Omega$  (MAX9716/MAX9717A),  $IN_+ = BIAS$  (MAX9716),  $BTL/SE = GND$  (MAX9717\_),  $R_L = \infty$  connected between  $OUT_+$  and  $OUT_-$ . Typical values are at  $T_A = +25^\circ C$ .) (Note 2)

PARAMETER	SYMBOL	CONDITIONS	MIN	TYP	MAX	UNITS
Quiescent Supply Current	$I_{CC}$	$V_{IN-} = V_{IN+} = V_{BIAS}$ (Note 3), $T_A = -40^\circ C$ to $+85^\circ C$		4	8.0	mA
Shutdown Supply Current	$I_{SHDN}$	$\overline{SHDN} = GND$		0.01	1	$\mu A$
$\overline{SHDN}$ Threshold	$V_{IH}$		1.2			V
	$V_{IL}$				0.4	
$\overline{BTL/SE}$ Threshold	$V_{IH}$		0.9 x $V_{CC}$			V
	$V_{IL}$				0.7 x $V_{CC}$	
Common-Mode Bias Voltage	$V_{BIAS}$	(Note 4)	$V_{CC}/2$ -9%	$V_{CC}/2$	$V_{CC}/2$ +9%	V
Output Offset Voltage	$V_{OS}$	$V_{IN-} = V_{OUT+}$ , $V_{IN+} = V_{BIAS}$ (Note 5)		$\pm 7$	$\pm 15$	mV
Power-Supply Rejection Ratio	PSRR	$V_{IN+} = V_{BIAS}$ , $V_{RIPPLE} = 200mV_{P-P}$ , $R_L = 8\Omega$ (Note 6)	$f = 217Hz$	61		dB
			$f = 1kHz$	73		
Output Power	$P_{OUT}$	$R_L = 8\Omega$ , $THD+N = 1\%$ , $f_{IN} = 1kHz$ (Note 7)		350		mW
		$R_L = 4\Omega$ , $THD+N = 1\%$ , $f_{IN} = 1kHz$ (Note 7)		525		
Total Harmonic Distortion Plus Noise	THD+N	$A_V = 6dB$ , $R_L = 8\Omega$ , $f_{IN} = 1kHz$ , $P_{OUT} = 0.5W$ , $V_{CC} = 3V$ (Note 8)		0.024		%
Output-Noise Density	$e_n$	$f_{IN} = 10kHz$		106		$nV/\sqrt{Hz}$
Signal-to-Noise Ratio	SNR	$THD+N = 1\%$		100		dB

# Low-Cost, Mono, 1.4W BTL Audio Power Amplifiers

## ELECTRICAL CHARACTERISTICS—3V Supply (continued)

( $V_{CC} = 3V$ ,  $V_{GND} = 0V$ ,  $\overline{SHDN} = V_{CC}$ ,  $T_A = +25^\circ C$ .  $C_{BIAS} = 1\mu F$ ,  $R_{IN} = R_F = 20k\Omega$  (MAX9716/MAX9717A),  $IN+ = BIAS$  (MAX9716),  $BTL/SE = GND$  (MAX9717\_),  $R_L = \infty$  connected between  $OUT+$  and  $OUT-$ . Typical values are at  $T_A = +25^\circ C$ .) (Note 2)

PARAMETER	SYMBOL	CONDITIONS	MIN	TYP	MAX	UNITS
Output Short-Circuit Current Limit	$I_{SC}$	(Note 9)		1.1		A
Thermal Shutdown Threshold				+160		$^\circ C$
Thermal Shutdown Hysteresis				15		$^\circ C$
Power-Up/Enable from Shutdown Time (Note 10)	$t_{PU}$			250		ms
		$C_{BIAS} = 0.1\mu F$		25		
Shutdown Time	$t_{SHDN}$			5		$\mu s$
Input Resistance	$R_{IN}$	MAX9717B/C/D	12	20	28	$k\Omega$

**Note 1:** Continuous power dissipation must also be observed.

**Note 2:** All specifications are tested at  $T_A = +25^\circ C$ . Specifications over temperature ( $T_A = T_{MIN}$  to  $T_{MAX}$ ) are not production tested, and guaranteed by design.

**Note 3:** Quiescent power-supply current is specified and tested with no load. Quiescent power-supply current depends on the off-set voltage when a practical load is connected to the amplifier.

**Note 4:** Common-mode bias voltage is the voltage on BIAS and is nominally  $V_{CC}/2$ .

**Note 5:**  $V_{OS} = V_{OUT+} - V_{OUT-}$ .

**Note 6:** The amplifier input  $IN-$  is AC-coupled to GND through  $C_{IN}$ .

**Note 7:** Output power is specified by a combination of a functional output current test and characterization analysis.

**Note 8:** Measurement bandwidth for THD+N is 22Hz to 22kHz.

**Note 9:** Extended short-circuit conditions result in a pulsed output.

**Note 10:** Time for  $V_{OUT}$  to rise to 50% of final DC value.

# Low-Cost, Mono, 1.4W BTL Audio Power Amplifiers

## Typical Operating Characteristics

( $V_{CC} = 5V$ , THD+N measurement bandwidth = 22Hz to 22kHz, BTL mode,  $T_A = +25^\circ C$ , unless otherwise noted.)

MAX9716/MAX9717

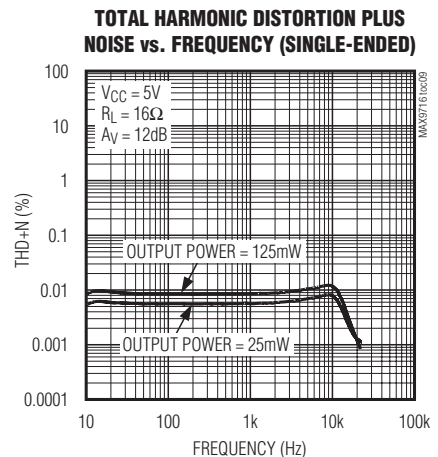
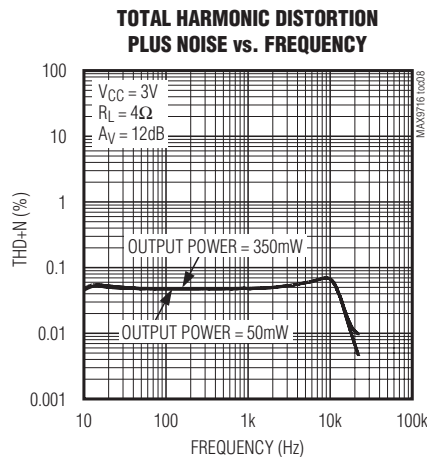
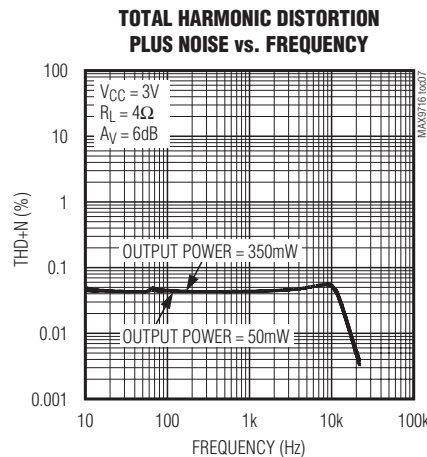
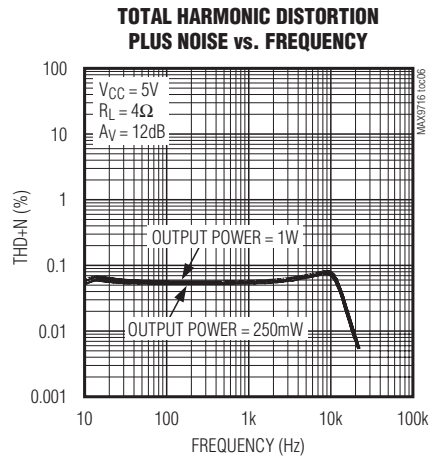
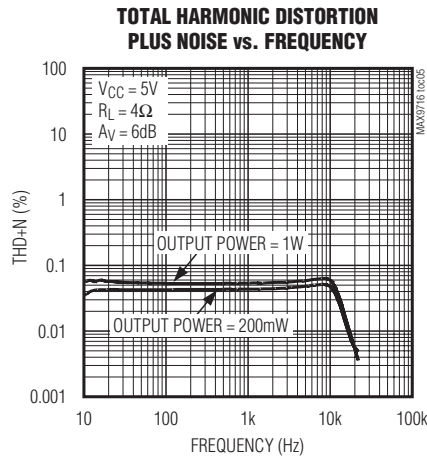
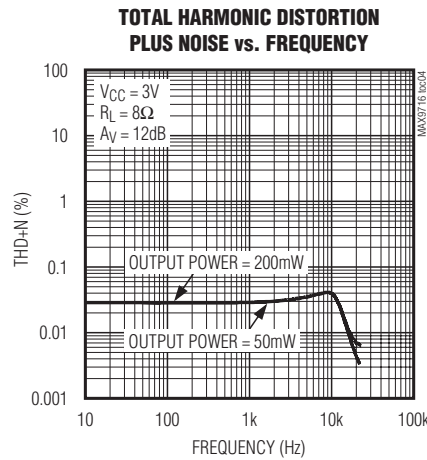
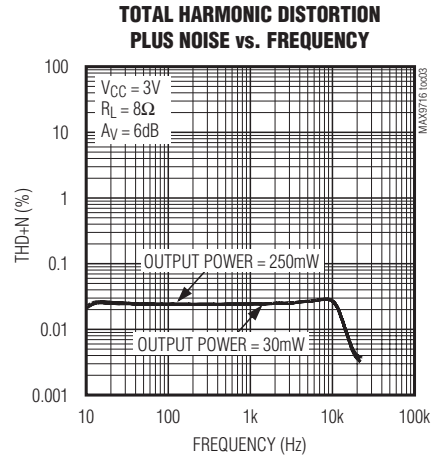
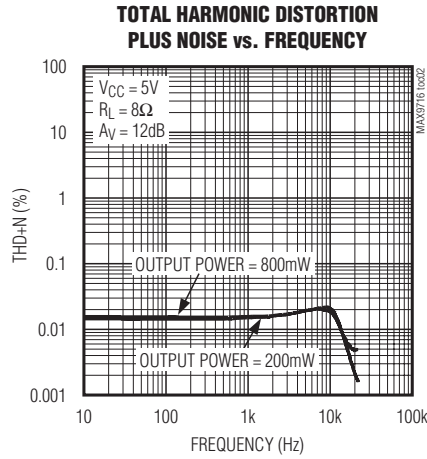
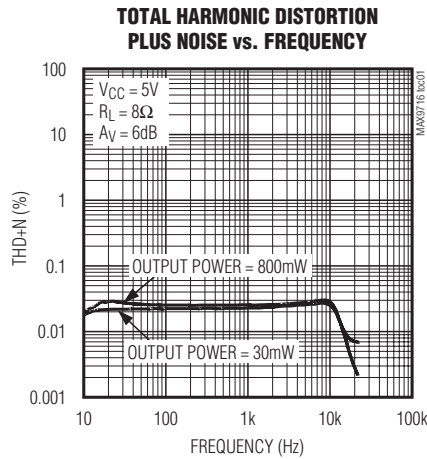

# Low-Cost, Mono, 1.4W BTL Audio Power Amplifiers

## Typical Operating Characteristics (continued)

( $V_{CC} = 5V$ , THD+N measurement bandwidth = 22Hz to 22kHz, BTL mode,  $T_A = +25^\circ C$ , unless otherwise noted.)

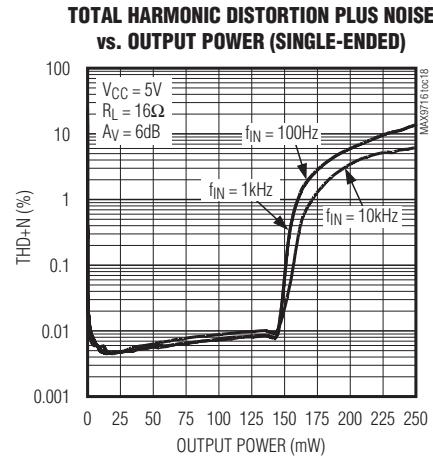
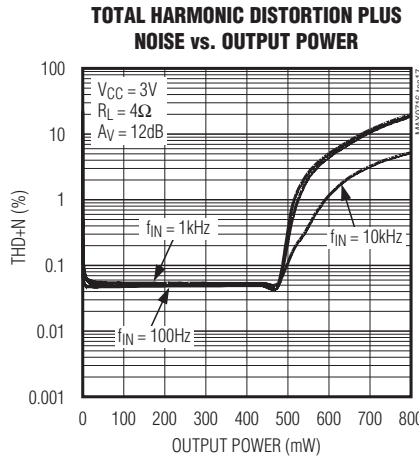
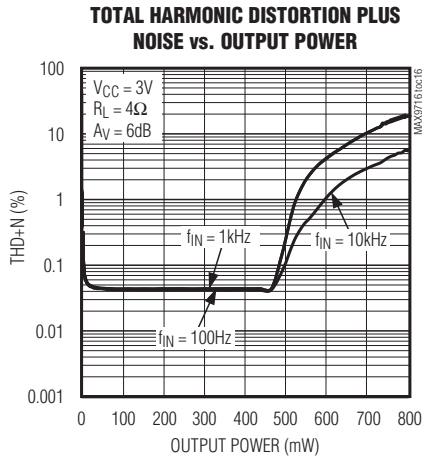
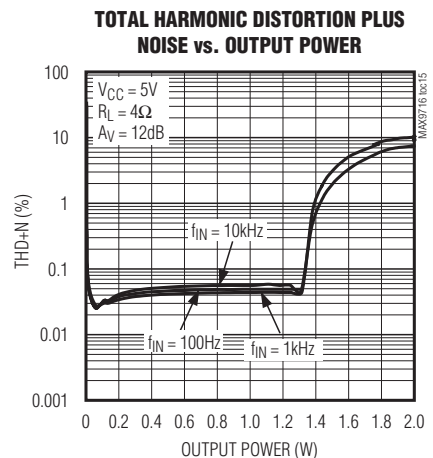
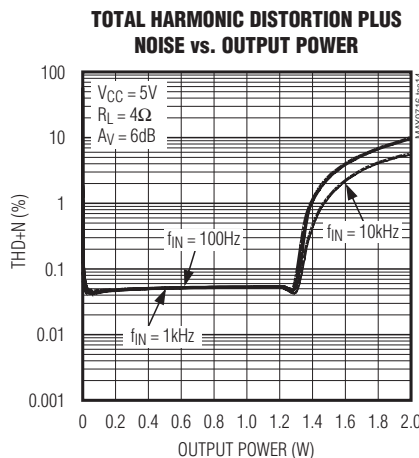
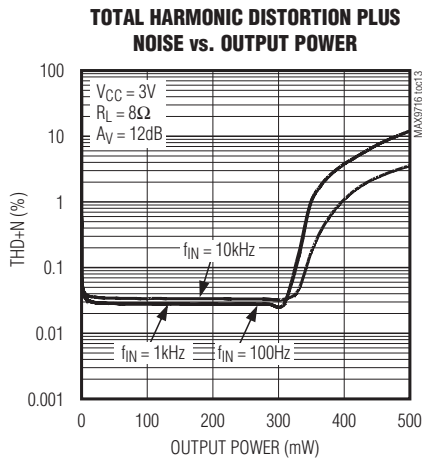
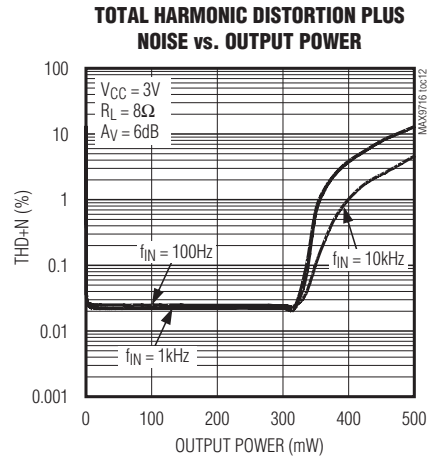
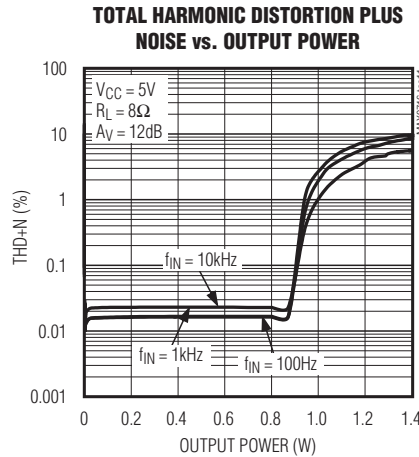
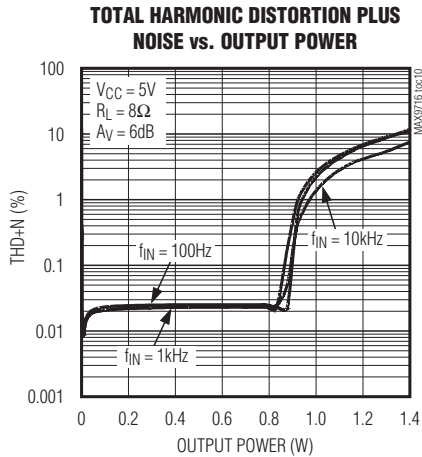

# Low-Cost, Mono, 1.4W BTL Audio Power Amplifiers

## Typical Operating Characteristics (continued)

( $V_{CC} = 5V$ , THD+N measurement bandwidth = 22Hz to 22kHz, BTL mode,  $T_A = +25^\circ C$ , unless otherwise noted.)

MAX9716/MAX9717

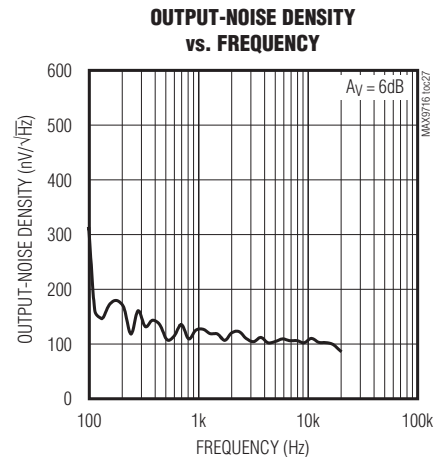
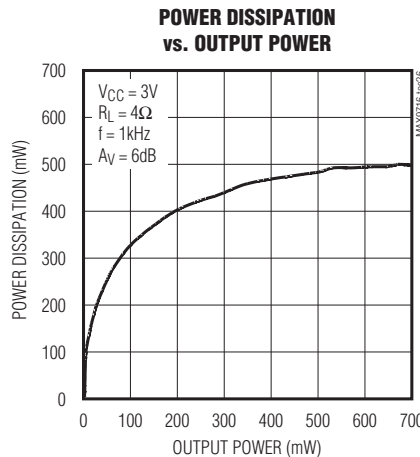
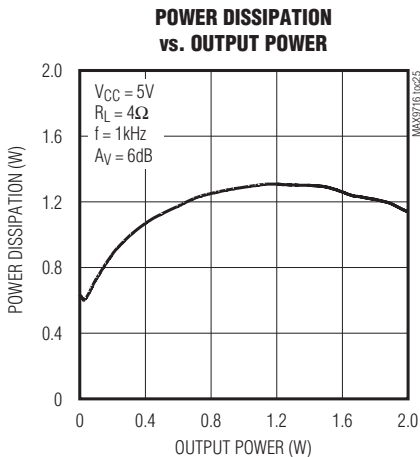
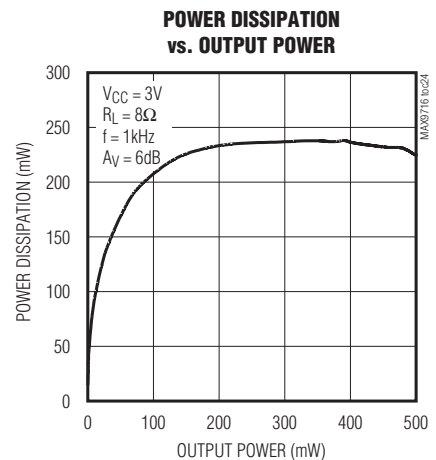
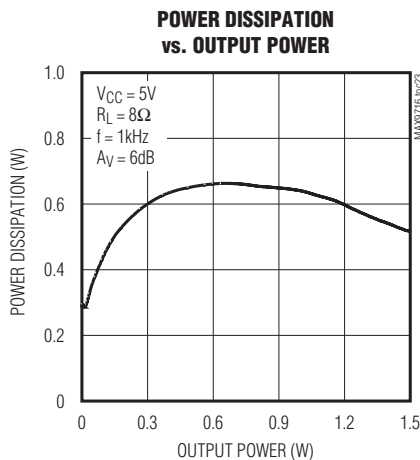
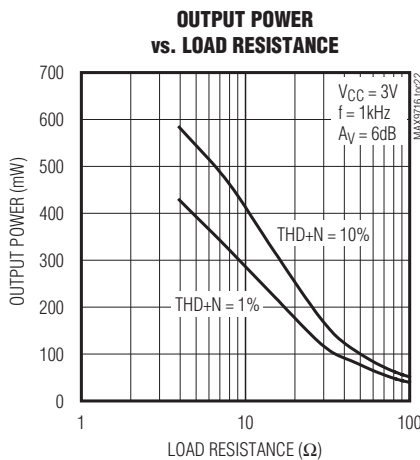
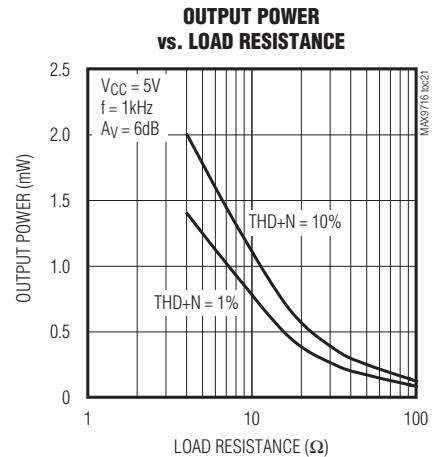
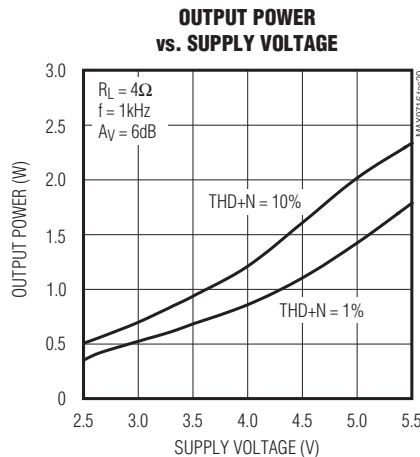
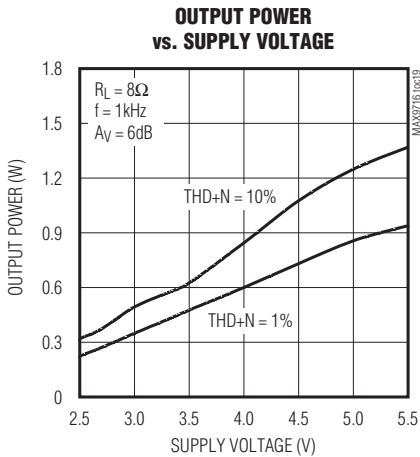

# Low-Cost, Mono, 1.4W BTL Audio Power Amplifiers

## Typical Operating Characteristics (continued)

( $V_{CC} = 5V$ , THD+N measurement bandwidth = 22Hz to 22kHz, BTL mode,  $T_A = +25^\circ C$ , unless otherwise noted.)

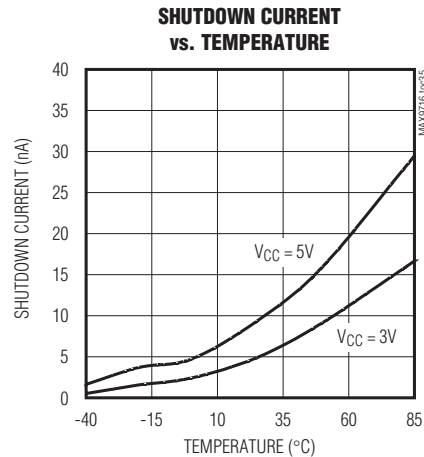
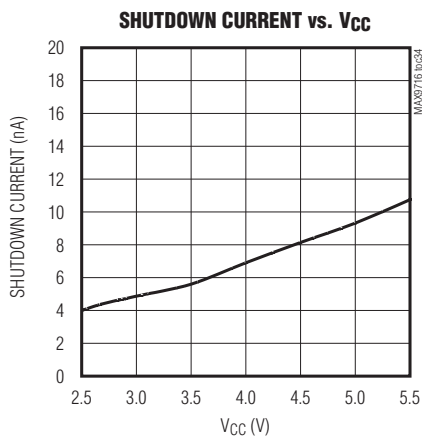
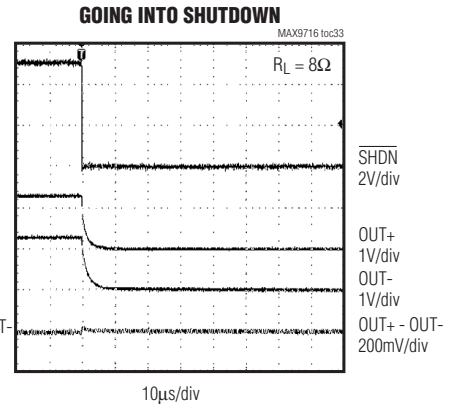
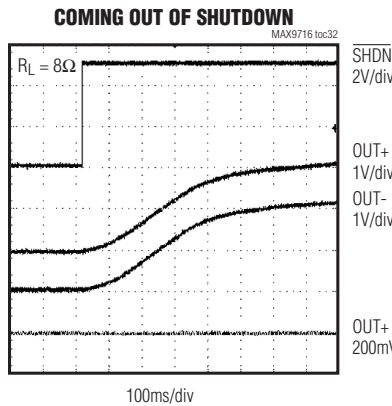
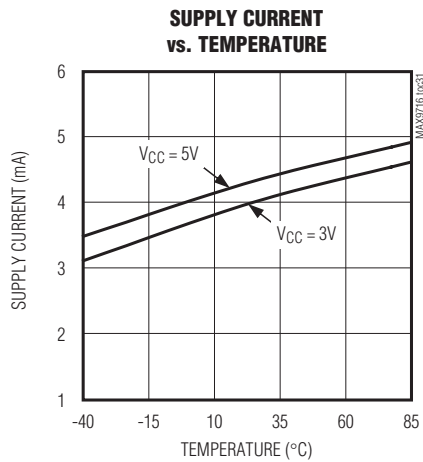
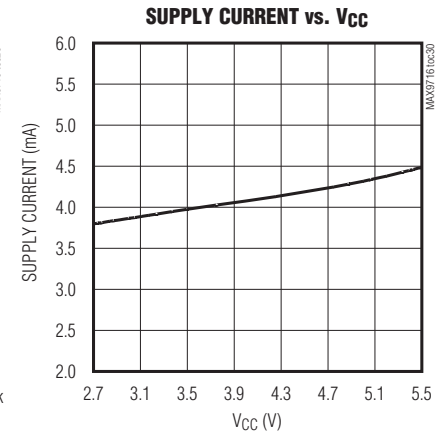
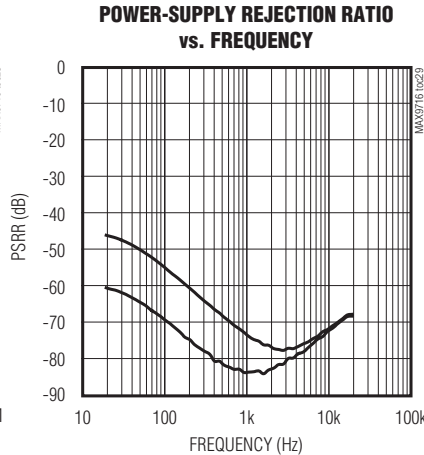
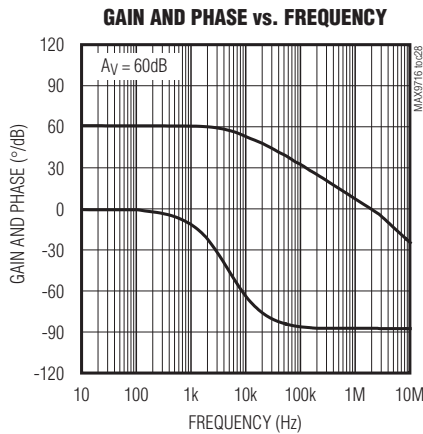

# Low-Cost, Mono, 1.4W BTL Audio Power Amplifiers

## Pin/Bump Description

MAX9716/MAX9717

PIN		BUMP		NAME	FUNCTION
TDFN/ $\mu$ MAX		UCSP			
MAX9716	MAX9717	MAX9716	MAX9717		
1	1	C3	C3	$\overline{\text{SHDN}}$	Active-Low Shutdown
2	2	C1	C1	BIAS	DC Bias Bypass Capacitor Connection. Bypass BIAS to ground with a 1 $\mu$ F capacitor.
3	—	A3	—	IN+	Noninverting Input
4	4	A1	A1	IN-	Inverting Input
5	5	A2	A2	OUT+	Bridge Amplifier Positive Output
6	6	B3	B3	V <sub>CC</sub>	Power Supply. Bypass V <sub>CC</sub> with a 1 $\mu$ F capacitor to ground.
7	7	B1, B2	B1, B2	GND	Ground
8	8	C2	C2	OUT-	Bridge Amplifier Negative Output. OUT- becomes high-impedance when $\overline{\text{BTL/SE}}$ is driven high.
—	3	—	A3	$\overline{\text{BTL/SE}}$	$\overline{\text{BTL}}$ /Single-Ended Mode Input. Logic low sets the device in BTL mode. Logic high sets the device in single-ended mode.
—	—	—	—	EP	Exposed Pad (TDFN and $\mu$ MAX Only). Connect EP to GND.

### Detailed Description

The MAX9716/MAX9717 are 1.3W BTL speaker amplifiers. Both devices feature a low-power shutdown mode, and industry-leading click-and-pop suppression. The MAX9717 features a headphone sense input that disables the slave BTL amplifier to drive the headphone as a single-ended load. These devices consist of high output-current audio amps configured as BTL amplifiers (see *Functional Diagrams*). The closed-loop gain of the input op amp sets the single-ended gain of the device. Two external gain resistors set the gain of the MAX9716 and MAX9717A (see the *Gain-Setting Resistor* section). The MAX9717B/C/D feature internally set gains of 6dB, 9dB, and 12dB, respectively.

The output of the first amplifier serves as the input of the second amplifier, which is configured as an inverting unity-gain follower. This results in two outputs, identical in amplitude, but 180° out-of-phase.

#### BIAS

The MAX9716/MAX9717 operate from a single 2.7V to 5.5V supply and feature an internally generated, common-mode bias voltage of V<sub>CC</sub>/2 referenced to ground. BIAS provides both click-and-pop suppression and sets the DC bias level for the audio outputs. The MAX9716 can be configured as a single-ended or differential input. For single-ended input, connect the noninverting input IN+ to BIAS externally. The MAX9717 BIAS is internally connected to the amplifier noninverting input IN+.

The MAX9717 can only be used with a

single-ended input. Always bypass BIAS to ground with a capacitor. Choose the value of the bypass capacitor as described in the *BIAS Capacitor* section. Do not connect external loads to BIAS. Any load lowers the BIAS voltage, affecting the overall performance of the device.

#### $\overline{\text{BTL/SE}}$ Control Input

The MAX9717 features a headphone sense input,  $\overline{\text{BTL/SE}}$ , that enables headphone jack sensing to control the power amplifier output configuration. Driving  $\overline{\text{BTL/SE}}$  low enables the slave amplifier (OUT-). Driving  $\overline{\text{BTL/SE}}$  high disables the slave amplifier.

#### Shutdown Mode

The MAX9716/MAX9717 feature a low-power shutdown mode that reduces quiescent current consumption to 10nA. Entering shutdown disables the bias circuitry, forces the amplifier outputs to GND through an internal 20k $\Omega$  resistor. Drive  $\overline{\text{SHDN}}$  low to enter shutdown mode; drive  $\overline{\text{SHDN}}$  high for normal operation.

#### Click-and-Pop Suppression

The MAX9716/MAX9717 feature Maxim's industry-leading click-and-pop suppression circuitry. During startup, the amplifier common-mode bias voltage ramps to the DC bias. When entering shutdown, the amplifier outputs are pulled to GND through an internal 20k $\Omega$  resistor. This scheme minimizes the energy present in the audio band.

# Low-Cost, Mono, 1.4W BTL Audio Power Amplifiers

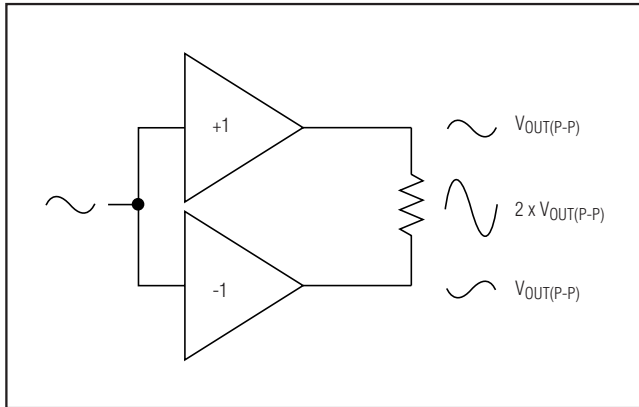

Figure 1. Bridge-Tied Load Configuration

## Applications Information

### BTL Amplifier

The MAX9716/MAX9717 are designed to drive a load differentially, a configuration referred to as bridge-tied load or BTL. The BTL configuration (Figure 1) offers advantages over the single-ended configuration, where one side of the load is connected to ground. Driving the load differentially doubles the output voltage compared to a single-ended amplifier under similar conditions. Thus, the differential gain of the device is twice the closed-loop gain of the input amplifier. The effective gain is given by:

$$A_V = 2 \times \frac{R_F}{R_{IN}}$$

Substituting  $2 \times V_{OUT(P-P)}$  for  $V_{OUT(P-P)}$  into the following equations yields four times the output power due to doubling of the output voltage:

$$V_{RMS} = \frac{V_{OUT(P-P)}}{2\sqrt{2}}$$

$$P_{OUT} = \frac{V_{RMS}^2}{R_L}$$

There is no net DC voltage across the load because the differential outputs are each biased at midsupply. This eliminates the need for DC-blocking capacitors required for single-ended amplifiers. These capacitors can be large and expensive, consume board space, and degrade low-frequency performance.

### Power Dissipation and Heat Sinking

Under normal operating conditions, the MAX9716/MAX9717 dissipate a significant amount of power. The maximum power dissipation for each package is given in the *Absolute Maximum Ratings* section under Continuous Power Dissipation or can be calculated by the following equation:

$$P_{DISSPKG(MAX)} = \frac{T_{J(MAX)} - T_A}{\theta_{JA}}$$

where  $T_{J(MAX)}$  is  $+150^\circ\text{C}$ ,  $T_A$  is the ambient temperature, and  $\theta_{JA}$  is the reciprocal of the derating factor in  $^\circ\text{C/W}$  as specified in the *Absolute Maximum Ratings* section. For example,  $\theta_{JA}$  of the TDFN package is  $41^\circ\text{C/W}$ .

The increase in power delivered by the BTL configuration directly results in an increase in internal power dissipation over the single-ended configuration. The maximum power dissipation for a given  $V_{CC}$  and load is given by the following equation:

$$P_{DISS(MAX)} = \frac{2V_{CC}^2}{\pi^2 R_L}$$

If the power dissipation for a given application exceeds the maximum allowed for a given package, reduce power dissipation by increasing the ground plane heat-sinking capability and the size of the traces to the device (see the *Layout and Grounding* section). Other methods for reducing power dissipation are to reduce  $V_{CC}$ , increase load impedance, decrease ambient temperature, reduce gain, or reduce input signal.

Thermal-overload protection limits total power dissipation in the MAX9716/MAX9717. Thermal protection circuitry disables the amplifier output stage when the junction temperature exceeds  $+160^\circ\text{C}$ . The amplifiers are enabled once the junction temperature cools by  $15^\circ\text{C}$ . A pulsing output under continuous thermal-overload conditions results as the device heats and cools.

### Fixed Gain

The MAX9717B, MAX9717C, and MAX9717D feature internally fixed gains of 6dB, 9dB, and 12dB, respectively (see the *Selector Guide*). Fixed gain simplifies designs, reduces pin count, decreases required footprint size, and eliminates external gain-setting resistors. Resistors  $R_{IN}$  and  $R_F$  shown in the MAX9717B/C/D *Typical Operating Circuit* are used to achieve each fixed gain.

# Low-Cost, Mono, 1.4W BTL Audio Power Amplifiers

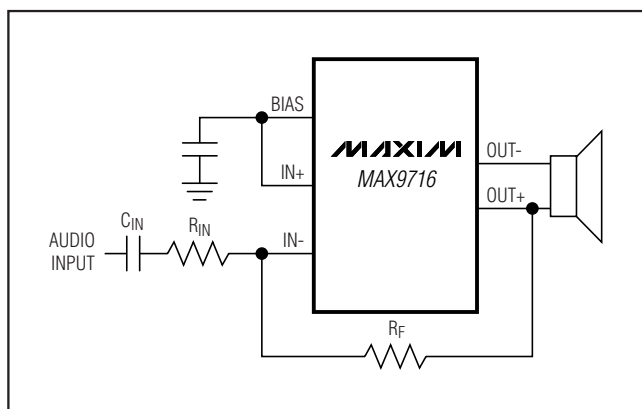

Figure 2. Setting the MAX9716/MAX9717A Gain

## Adjustable Gain Gain-Setting Resistors

External feedback resistors set the gain of the MAX9716 and MAX9717A. Resistors  $R_F$  and  $R_{IN}$  (see Figure 2) set the gain of the amplifier as follows:

$$A_V = 2 \left( \frac{R_F}{R_{IN}} \right)$$

Where  $A_V$  is the desired voltage gain. Hence, an  $R_{IN}$  of  $20k\Omega$  and an  $R_F$  of  $20k\Omega$  yields a gain of  $2V/V$ , or  $6dB$ .  $R_F$  can be either fixed or variable, allowing the use of a digitally controlled potentiometer to alter the gain under software control.

The gain of the MAX9717 in a single-ended output configuration is half the gain when configured as BTL output. Choose  $R_F$  between  $10k\Omega$  and  $50k\Omega$  for the MAX9716 and MAX9717A. Gains for the MAX9717B/C/D are set internally.

## Input Filter

$C_{IN}$  and  $R_{IN}$  form a highpass filter that removes the DC bias from an incoming signal. The AC-coupling capacitor allows the amplifier to bias the signal to an optimal DC level. Assuming zero-source impedance, the  $-3dB$  point of the highpass filter is:

$$f_{-3dB} = \frac{1}{2\pi R_{IN} C_{IN}}$$

Setting  $f_{-3dB}$  too high affects the low-frequency response of the amplifier. Use capacitors with dielectrics that have low-voltage coefficients, such as tantalum or aluminum electrolytic. Capacitors with high-voltage coefficients, such as ceramics, can increase distortion at low frequencies.

## Output-Coupling Capacitor

The MAX9717 require output-coupling capacitors to operate in single-ended (headphone) mode. The output-coupling capacitor blocks the DC component of the amplifier output, preventing DC current from flowing to the load. The output capacitor and the load impedance form a highpass filter with a  $-3dB$  point determined by:

$$f_{-3dB} = \frac{1}{2\pi R_L C_{OUT}}$$

As with the input capacitor, choose  $C_{OUT}$  such that  $f_{-3dB}$  is well below the lowest frequency of interest. Setting  $f_{-3dB}$  too high affects the amplifier's low-frequency response. Load impedance is a concern when choosing  $C_{OUT}$ . Load impedance can vary, changing the  $-3dB$  point of the output filter. A lower impedance increases the corner frequency, degrading low-frequency response. Select  $C_{OUT}$  such that the worst-case load/ $C_{OUT}$  combination yields an adequate response. Select capacitors with low ESR to minimize resistive losses and optimize power transfer to the load.

## Differential Input

The MAX9716 can be configured for a differential input. The advantage of differential inputs is that any common-mode noise is attenuated and not passed through the amplifier. This input improves noise rejection and provides common-mode rejection (Figure 3). External components should be closely matched for high CMRR. Figure 4 shows the MAX9716 configured for a differential input.

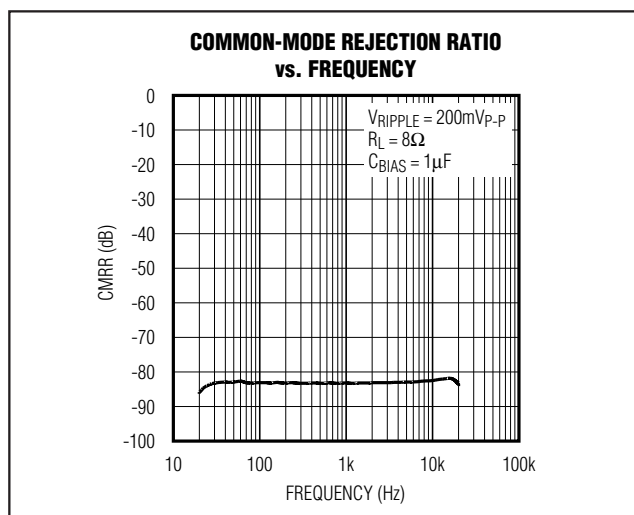

Figure 3. CMRR with Differential Input

# Low-Cost, Mono, 1.4W BTL Audio Power Amplifiers

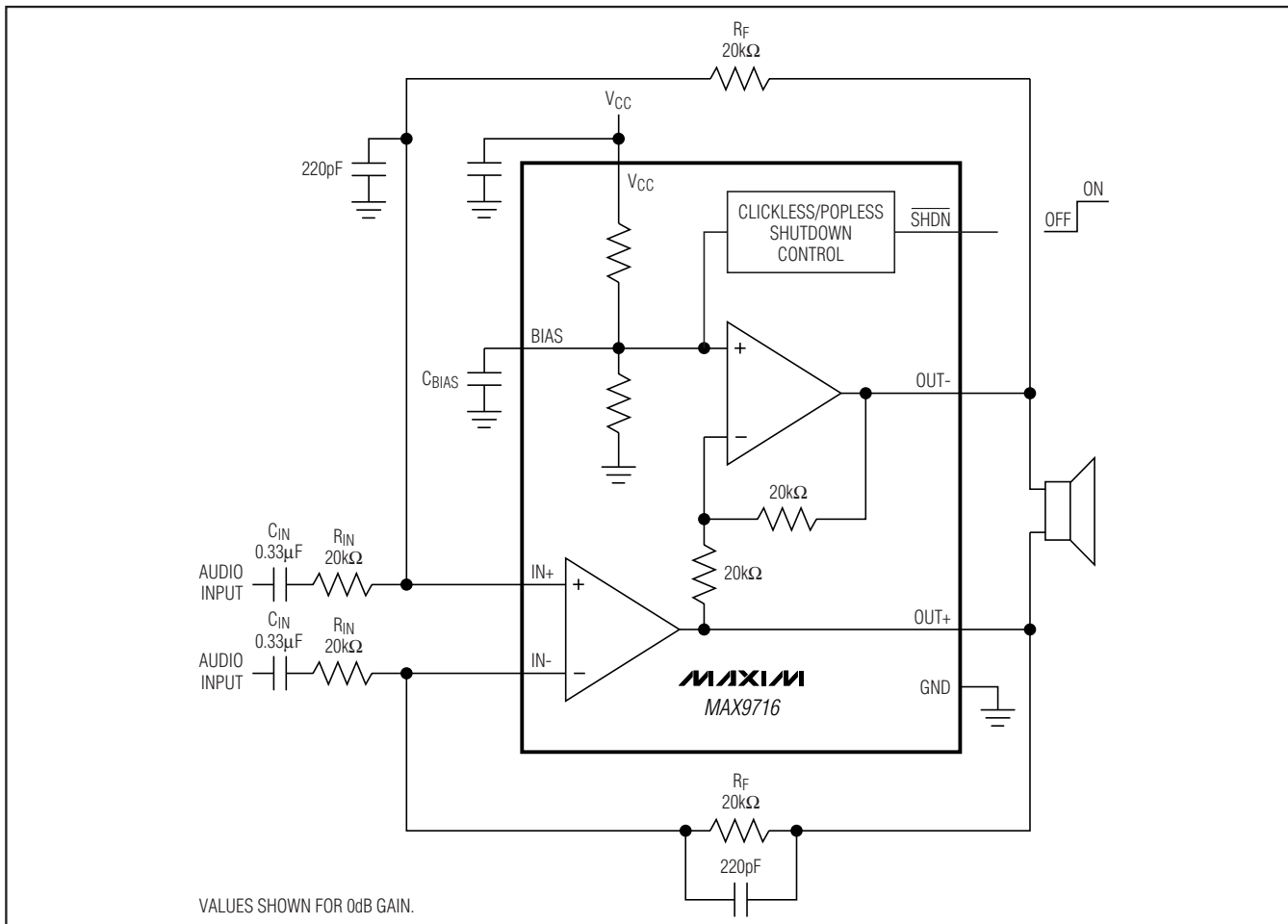

Figure 4. MAX9716 Differential Input

## BIAS Capacitor

BIAS is the output of the internally-generated  $V_{CC}/2$  bias voltage. The BIAS bypass capacitor,  $C_{BIAS}$ , improves the power-supply rejection ratio by reducing power supply and other noise sources at the common-mode bias node.  $C_{BIAS}$  also generates the clickless/popless startup DC bias waveform for the speaker amplifiers. Bypass BIAS with a  $1\mu\text{F}$  capacitor to GND. Larger  $C_{BIAS}$  values improve PSRR but slow down  $t_{ON}$  time. Do not connect external loads to BIAS.

## Supply Bypassing

Proper power-supply bypassing ensures low-noise, low-distortion performance. Connect a  $1\mu\text{F}$  ceramic capacitor from  $V_{CC}$  to GND. Add additional bulk capacitance as required by the application. Connect the bypass capacitor as close to the device as possible.

## Layout and Grounding

Proper PC board layout and grounding is essential for optimizing performance. Use large traces for the power-supply inputs and amplifier outputs to minimize losses due to parasitic trace resistance. Large traces also aid in moving heat away from the package. Proper grounding improves audio performance and prevents digital switching noise from coupling into the audio signal.

The MAX9716/MAX9717 TDFN and  $\mu\text{MAX}$  packages feature exposed thermal pads on their undersides. This pad lowers the thermal resistance of the package by providing a direct-heat conduction path from the die to the printed circuit board. Connect the exposed pad to the ground plane using multiple vias, if required.

# Low-Cost, Mono, 1.4W BTL Audio Power Amplifiers

MAX9716/MAX9717

## UCSP Applications Information

For the latest application details on UCSP construction, dimensions, tape carrier information, printed circuit board techniques, bump-pad layout, and recommended reflow temperature profile, as well as the latest information on reliability testing results, refer to the application note, "UCSP—A Wafer-Level Chip-Scale Package" available on Maxim's web site at <http://www.maxim-ic.com/ucsp>.

## UCSP Marking Information

Pin A1 Bump Indicator

**AAA:** Product ID code

**XXX:** Lot Code



## Ordering Information (continued)

PART	TEMP RANGE	PIN-PACKAGE	GAIN (dB)
MAX9717AEBL+TG45	-40°C to +85°C	3 x 3 UCSP	Adj.
MAX9717AETA+T	-40°C to +85°C	8 TDFN-EP*	Adj.
MAX9717AEUA	-40°C to +85°C	8 μMAX-EP*	Adj.
MAX9717BEBL+TG45	-40°C to +85°C	3 x 3 UCSP	6
MAX9717BETA+T	-40°C to +85°C	8 TDFN-EP*	6
MAX9717BEUA	-40°C to +85°C	8 μMAX-EP*	6
MAX9717CEBL+TG45	-40°C to +85°C	3 x 3 UCSP	9
MAX9717CETA+T	-40°C to +85°C	8 TDFN-EP*	9
MAX9717CEUA	-40°C to +85°C	8 μMAX-EP*	9
MAX9717DEBL+TG45	-40°C to +85°C	3 x 3 UCSP	12
MAX9717DETA+T	-40°C to +85°C	8 TDFN-EP*	12
MAX9717DEUA	-40°C to +85°C	8 μMAX-EP*	12

\*EP = Exposed pad.

+Denotes a lead(Pb)-free/RoHS-compliant package.

G45 indicates protective die coating.

## Selector Guide

PART	BTL/SE INPUT	GAIN (dB)
MAX9716	—	Adjustable
MAX9717A	√	Adjustable
MAX9717B	√	6
MAX9717C	√	9
MAX9717D	√	12

## Chip Information

PROCESS: BiCMOS

# Low-Cost, Mono, 1.4W BTL Audio Power Amplifiers

## Pin/Bump Configurations

TOP VIEW

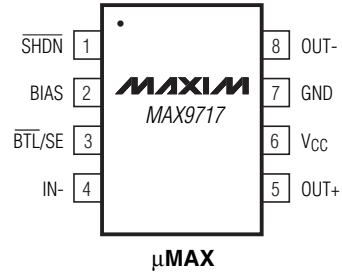
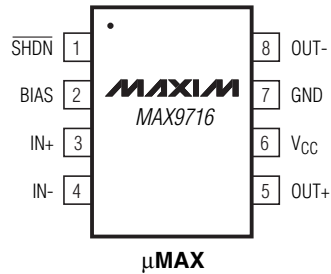

TOP VIEW  
(BUMPS ON BOTTOM)

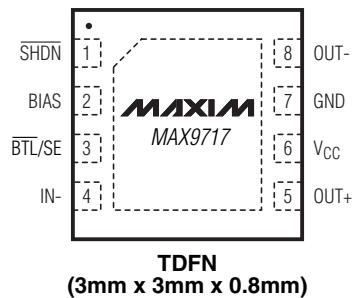
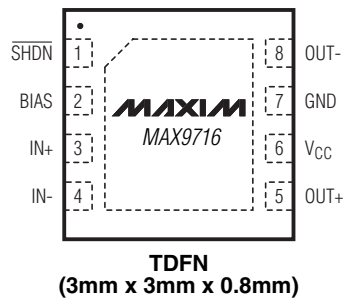
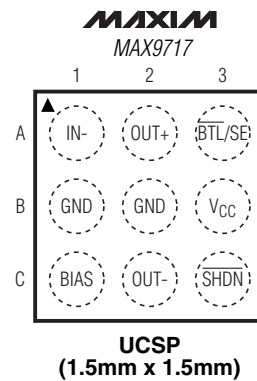
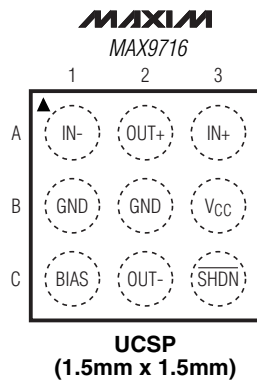

# Low-Cost, Mono, 1.4W BTL Audio Power Amplifiers

## Functional Diagrams/Typical Operating Circuits

MAX9716/MAX9717

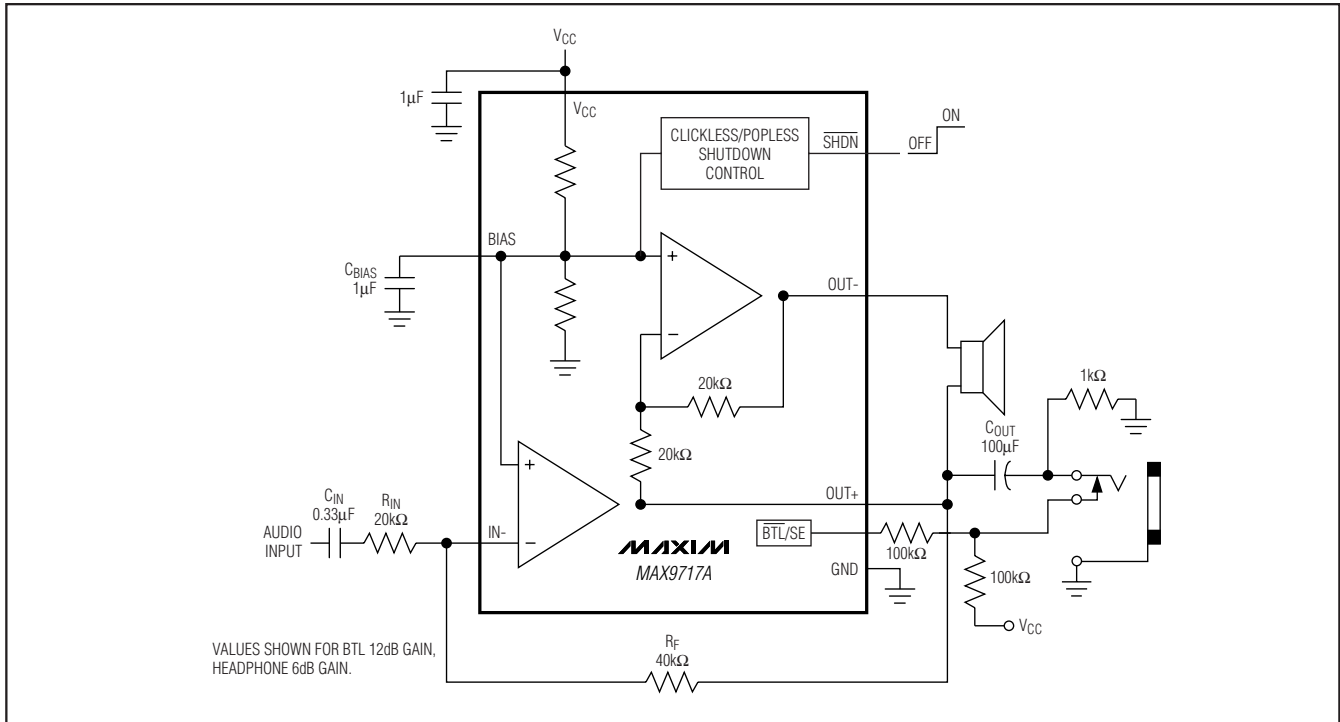
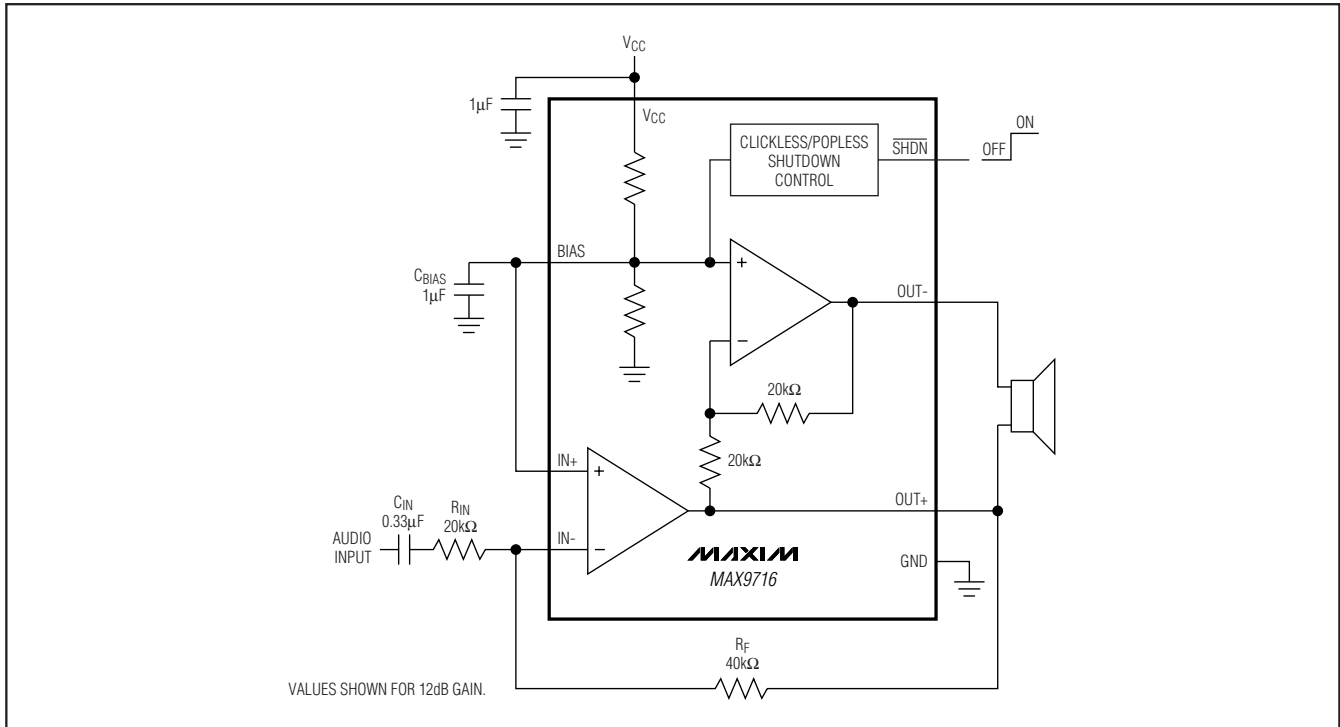

# Low-Cost, Mono, 1.4W BTL Audio Power Amplifiers

MAX9716/MAX9717

## Functional Diagrams/Typical Operating Circuits (continued)

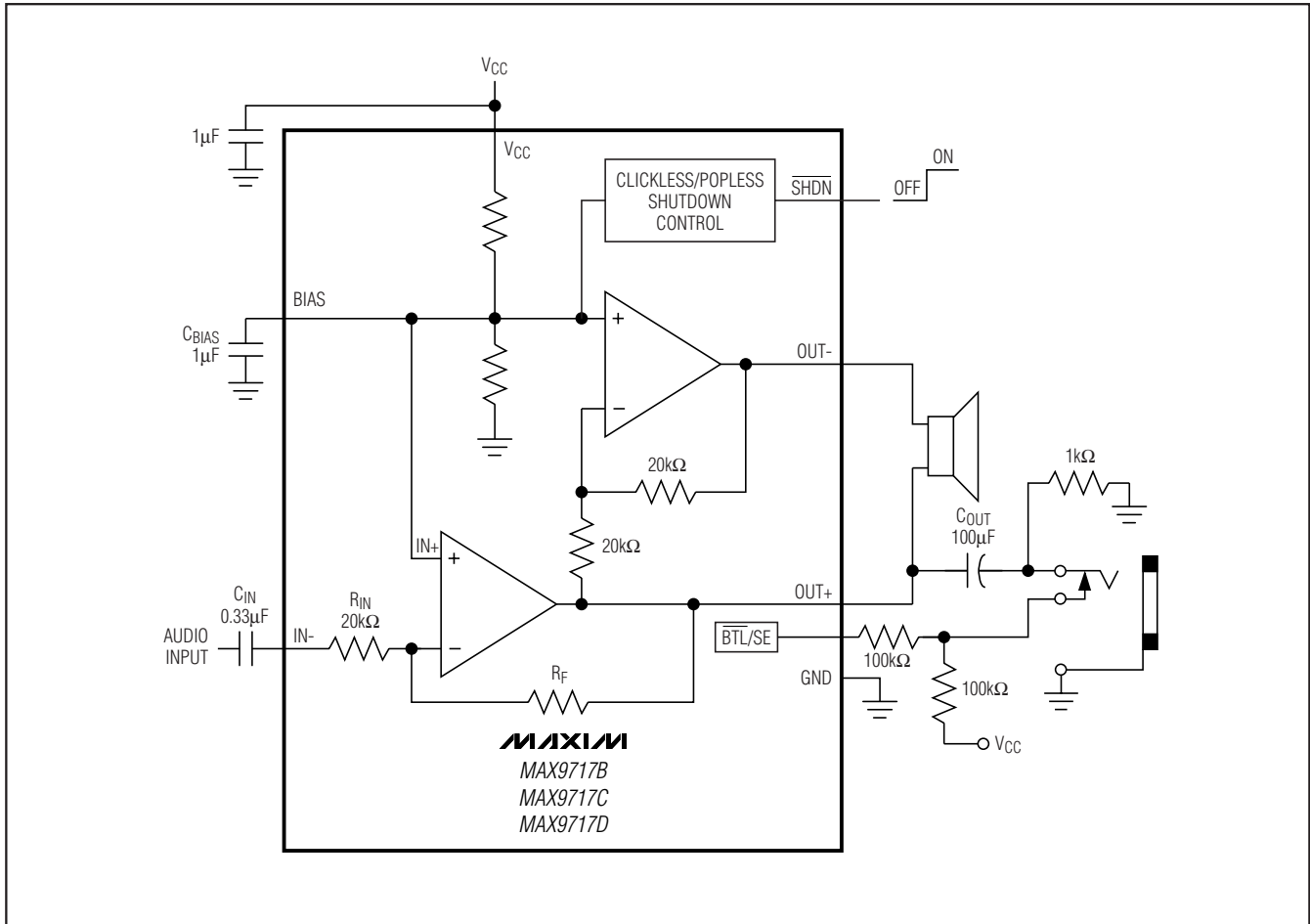

# Low-Cost, Mono, 1.4W BTL Audio Power Amplifiers

## Package Information

For the latest package outline information and land patterns (footprints), go to [www.maxim-ic.com/packages](http://www.maxim-ic.com/packages). Note that a "+", "#", or "-" in the package code indicates RoHS status only. Package drawings may show a different suffix character, but the drawing pertains to the package regardless of RoHS status.

PACKAGE TYPE	PACKAGE CODE	OUTLINE NO.	LAND PATTERN NO.
8 $\mu$ MAX	U8E+2	<a href="#">21-0107</a>	<a href="#">90-0145</a>
8 TDFN-EP	T833+1	<a href="#">21-0137</a>	<a href="#">90-0059</a>
9 UCSP	B9+1	<a href="#">21-0093</a>	—

MAX9716/MAX9717

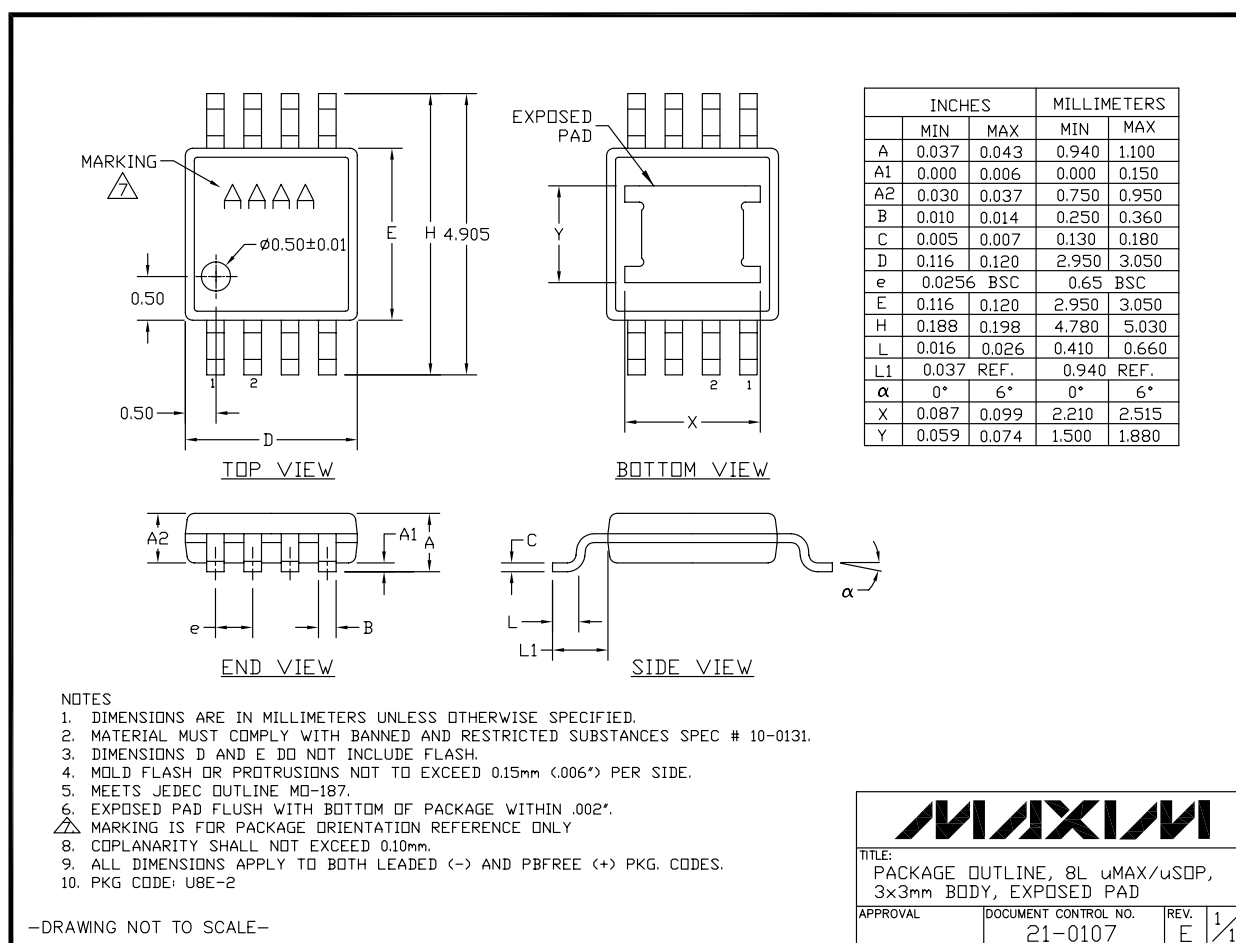

# Low-Cost, Mono, 1.4W BTL Audio Power Amplifiers

## Package Information (continued)

For the latest package outline information and land patterns (footprints), go to [www.maxim-ic.com/packages](http://www.maxim-ic.com/packages). Note that a "+", "#", or "-" in the package code indicates RoHS status only. Package drawings may show a different suffix character, but the drawing pertains to the package regardless of RoHS status.

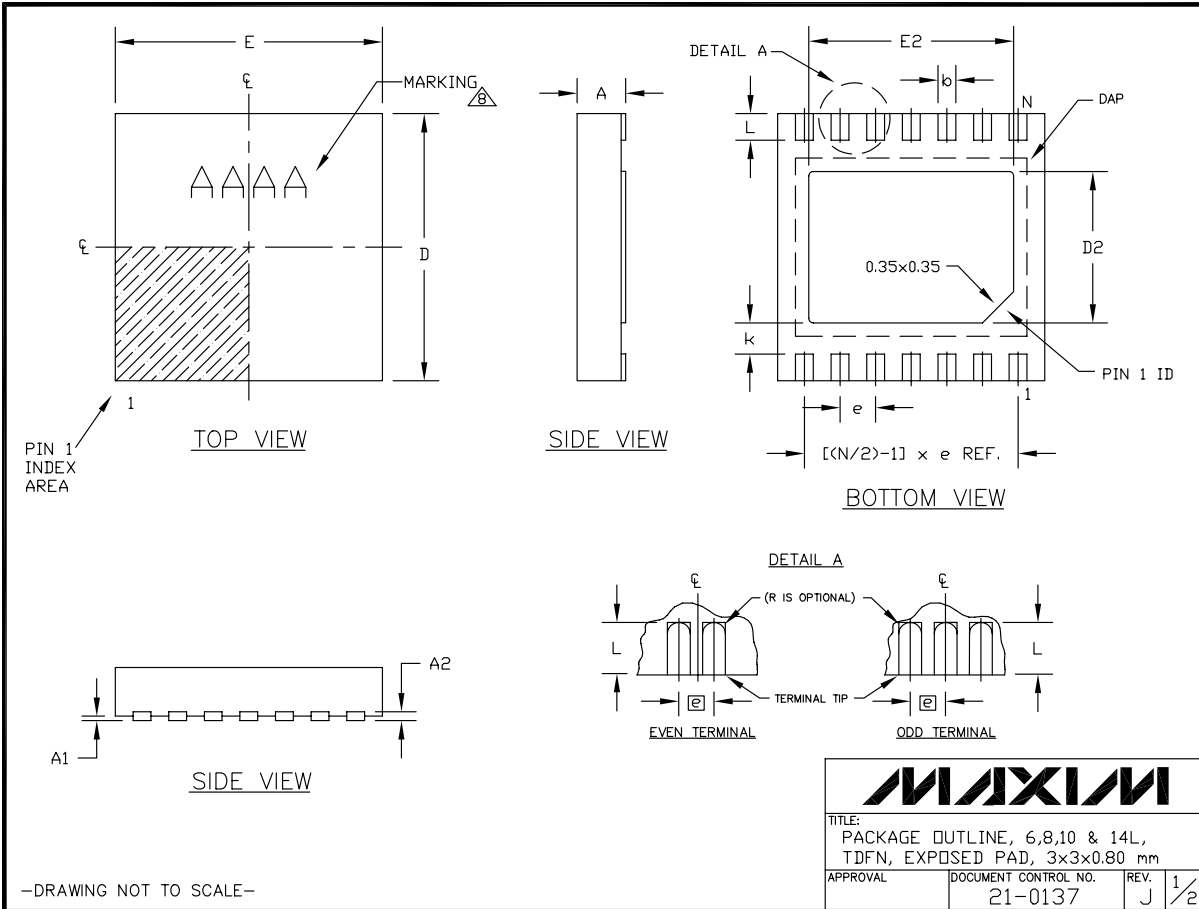

# Low-Cost, Mono, 1.4W BTL Audio Power Amplifiers

## Package Information (continued)

For the latest package outline information and land patterns (footprints), go to [www.maxim-ic.com/packages](http://www.maxim-ic.com/packages). Note that a "+", "#", or "-" in the package code indicates RoHS status only. Package drawings may show a different suffix character, but the drawing pertains to the package regardless of RoHS status.

MAX9716/MAX9717

COMMON DIMENSIONS		
SYMBOL	MIN.	MAX.
A	0.70	0.80
D	2.90	3.10
E	2.90	3.10
A1	0.00	0.05
L	0.20	0.40
k	0.25 MIN.	
A2	0.20 REF.	

PACKAGE VARIATIONS							
PKG. CODE	N	D2	E2	e	JEDEC SPEC	b	[(N/2)-1]xe
T633-2	6	1.50±0.10	2.30±0.10	0.95 BSC	MO229 /W EEA	0.40±0.05	1.90 REF
T833-2	8	1.50±0.10	2.30±0.10	0.65 BSC	MO229 /W EEC	0.30±0.05	1.95 REF
T833-3	8	1.50±0.10	2.30±0.10	0.65 BSC	MO229 /W EEC	0.30±0.05	1.95 REF
T1033-1	10	1.50±0.10	2.30±0.10	0.50 BSC	MO229 /W EED-3	0.25±0.05	2.00 REF
T1033MK-1	10	1.50±0.10	2.30±0.10	0.50 BSC	MO229 /W EED-3	0.25±0.05	2.00 REF
T1033-2	10	1.50±0.10	2.30±0.10	0.50 BSC	MO229 /W EED-3	0.25±0.05	2.00 REF
T1433-1	14	1.70±0.10	2.30±0.10	0.40 BSC	----	0.20±0.05	2.40 REF
T1433-2	14	1.70±0.10	2.30±0.10	0.40 BSC	----	0.20±0.05	2.40 REF
T1433-3F	14	1.70±0.10	2.30±0.10	0.40 BSC	----	0.20±0.05	2.40 REF

### NOTES:

1. ALL DIMENSIONS ARE IN mm. ANGLES IN DEGREES.
2. COPLANARITY SHALL NOT EXCEED 0.08 mm.
3. WARPAGE SHALL NOT EXCEED 0.10 mm.
4. PACKAGE LENGTH/PACKAGE WIDTH ARE CONSIDERED AS SPECIAL CHARACTERISTIC(S).
5. DRAWING CONFORMS TO JEDEC MO229, EXCEPT DIMENSIONS "D2" AND "E2", AND T1433-1 & T1433-2.
6. "N" IS THE TOTAL NUMBER OF LEADS.
7. NUMBER OF LEADS SHOWN ARE FOR REFERENCE ONLY.
8. MARKING IS FOR PACKAGE ORIENTATION REFERENCE ONLY.
9. ALL DIMENSIONS APPLY TO BOTH LEADED (-) AND PbFREE (+) PKG. CODES.

-DRAWING NOT TO SCALE-

		
TITLE: PACKAGE OUTLINE, 6,8,10 & 14L, TDFN, EXPOSED PAD, 3x3x0.80 mm		
APPROVAL	DOCUMENT CONTROL NO. 21-0137	REV. J 2/2

# Low-Cost, Mono, 1.4W BTL Audio Power Amplifiers

## Package Information (continued)

For the latest package outline information and land patterns (footprints), go to [www.maxim-ic.com/packages](http://www.maxim-ic.com/packages). Note that a "+", "#", or "-" in the package code indicates RoHS status only. Package drawings may show a different suffix character, but the drawing pertains to the package regardless of RoHS status.

**TOP VIEW**

**BOTTOM VIEW**

COMMON DIMENSIONS	
A	0.62±0.05-0.08
A1	0.29±0.02
A2	0.33 REF.
b	∅0.35±0.03
D1	1.00 BASIC
E1	1.00 BASIC
e	0.50 BASIC
SD	0.00 BASIC
SE	0.00 BASIC

PKG. CODE	VARIABLE DIMENSIONS		DEPOPULATED SOLDER BALLS
	D	E	
B9-1	1.52±0.05	1.52±0.05	NONE
B9-2	1.52±0.05	1.52±0.05	B2
B9-3	1.52±0.05	1.52±0.05	B1, B2, B3
B9-4	1.60±0.05	1.60±0.05	NONE
B9-5	1.60±0.05	1.60±0.05	B2
B9-6	1.60±0.05	1.60±0.05	B1, B2, B3
B9-7	1.52±0.05	1.52±0.05	A2, B1, B2, B3, C2
B9-8	1.98±0.05	1.75±0.05	B1, B2, B3

**NOTES:**

- All dimensions in millimeters.
- Outer dimension (D & E) is defined by center lines between scribe lines.
- Marking shown is for package orientation reference only. Number of characters and lines vary per product.
- All dimensions are applicable to Leaded (-), PbFree (+), and MaxFilm parts/pkg codes.

**SIDE VIEW**

TITLE:  
PACKAGE OUTLINE,  
9 BUMPS, 3X3 ARRAY, UCSP (B) PKG.

APPROVAL	DOCUMENT CONTROL NO. 21-0093	REV. M 1/1
----------	---------------------------------	------------

-DRAWING NOT TO SCALE-

# Low-Cost, Mono, 1.4W BTL Audio Power Amplifiers

## Revision History

REVISION NUMBER	REVISION DATE	DESCRIPTION	PAGES CHANGED
2	3/09	Added lead-free and G45 options to <i>Ordering Information</i>	1, 13
3	3/12	Add automotive qualified part	1



MAX9716/MAX9717

Maxim cannot assume responsibility for use of any circuitry other than circuitry entirely embodied in a Maxim product. No circuit patent licenses are implied. Maxim reserves the right to change the circuitry and specifications without notice at any time. The parametric values (min and max limits) shown in the Electrical Characteristics table are guaranteed. Other parametric values quoted in this data sheet are provided for guidance.

21 \_\_\_\_\_ **Maxim Integrated Products, 120 San Gabriel Drive, Sunnyvale, CA 94086 408-737-7600**

## Looking for pricing, stock, or lifecycle information?

Click below to explore more details on WIN SOURCE:

-  [View MAX9716EUA+](#) on WIN SOURCE
-  [Maxim Integrated](#) Information

## Optimize Your Supply Chain with WIN SOURCE Solutions

-  Global Sourcing Solution
-  Obsolete Management
-  Cost Control Management
-  Shortage Management
-  Alternative Solution
-  Excess Inventory Management