



**THE DATASHEET OF
MAX963ESD+**



MAX961–MAX964/ MAX997/MAX999

Single/Dual/Quad, Ultra-High-Speed, +3V/+5V, Beyond-the-Rails Comparators

General Description

The MAX961–MAX964/MAX997/MAX999 are low-power, ultra-high-speed comparators with internal hysteresis. These devices are optimized for single +3V or +5V operation. The input common-mode range extends 100mV Beyond-the-Rails™, and the outputs can sink or source 4mA to within 0.52V of GND and VCC. Propagation delay is 4.5ns (5mV overdrive), while supply current is 5mA per comparator.

The MAX961/MAX963/MAX964 and MAX997 have a shutdown mode in which they consume only 270µA supply current per comparator. The MAX961/MAX963 provide complementary outputs and a latch-enable feature. Latch enable allows the user to hold a valid comparator output. The MAX999 is available in a tiny 5-pin SOT23 package. The single MAX961/MAX997 and dual MAX962 are available in space-saving 8-pin µMAX® packages.

Applications

- Single 3V/5V Systems
- Portable/Battery-Powered Systems
- Threshold Detectors/Discriminators
- GPS Receivers
- Line Receivers
- Zero-Crossing Detectors
- High-Speed Sampling Circuits

Selector Guide

| PART | NO. OF COMPARATORS | COMPLEMENTARY OUTPUT | SHUTDOWN | LATCH ENABLE | PIN-PACKAGE |
|--------|--------------------|----------------------|----------|--------------|-------------|
| MAX961 | 1 | Yes | Yes | Yes | 8 SO/µMAX |
| MAX962 | 2 | No | No | No | 8 SO/µMAX |
| MAX963 | 2 | Yes | Yes | Yes | 14 SO |
| MAX964 | 4 | No | Yes | No | 16 SO/QSOP |
| MAX997 | 1 | No | Yes | No | 8 SO/µMAX |
| MAX999 | 1 | No | No | No | 5 SOT23 |

Beyond-the-Rails is a trademark and µMAX is a registered trademark of Maxim Integrated Products, Inc.

Features

- Ultra-Fast, 4.5ns Propagation Delay
- Ideal for +3V and +5V Single-Supply Applications
- Beyond-the-Rails Input Voltage Range
- Low, 5mA Supply Current (MAX997/MAX999)
- 3.5mV Internal Hysteresis for Clean Switching
- Output Latch (MAX961/MAX963)
- TTL/CMOS-Compatible Outputs
- Shutdown Mode (MAX961/MAX963/MAX964/MAX997)
- Available in Space-Saving Packages:
 - 5-Pin SOT23 (MAX999)
 - 8-Pin µMAX (MAX961/MAX962/MAX997)
 - 16-Pin QSOP (MAX964)

Ordering Information

| PART | PIN-PACKAGE | TOP MARK |
|--------------|--------------|----------|
| MAX961ESA | 8 SO | — |
| MAX961EUA-T | 8 µMAX | — |
| MAX962ESA | 8 SO | — |
| MAX962EUA-T | 8 µMAX | — |
| MAX963ESD | 14 SO | — |
| MAX964ESE | 16 Narrow SO | — |
| MAX964EEE | 16 QSOP | — |
| MAX997ESA | 8 SO | — |
| MAX997EUA-T | 8 µMAX | — |
| MAX999AAUK+T | 5 SOT23 | +AFEI |
| MAX999EUK-T | 5 SOT23 | ACAB |

Note: All E grade devices are specified over the -40°C to +85°C operating temperature range. MAX999AAUK is specified over the -40°C to +125°C operating temperature range.
+Denotes a lead(Pb)-free/RoHS-compliant package.

Pin Configurations

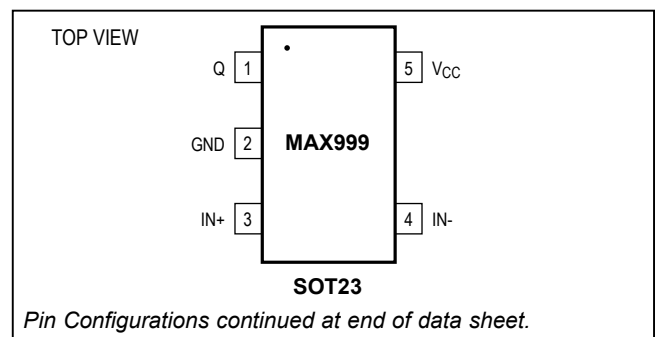

MAX961–MAX964/
MAX997/MAX999

Single/Dual/Quad, Ultra-High-Speed, +3V/+5V,
Beyond-the-Rails Comparators

Absolute Maximum Ratings

| | | | |
|---|------------------------------|---|-----------------|
| Supply Voltage, V_{CC} to GND | -0.3V to +6V | 14-Pin SO (derate 8.33mW/°C above +70°C)..... | 667mW/°C |
| All Other Pins | -0.3V to ($V_{CC} + 0.3V$) | 16-Pin SO (derate 8.70mW/°C above +70°C)..... | 696mW/°C |
| Current into Input Pins | $\pm 20mA$ | 16-Pin QSOP (derate 8.33mW/°C above +70°C) .. | 667mW/°C |
| Duration of Output Short Circuit to GND or V_{CC} | Continuous | Operating Temperature Range | |
| Continuous Power Dissipation ($T_A = +70^\circ C$) | | MAX96_E/MAX99_E | -40°C to +85°C |
| 5-Pin SOT23 (derate 7.1mW/°C above +70°C) | 571mW/°C | MAX999AAUK | -40°C to +125°C |
| 8-Pin SO (derate 5.88mW/°C above +70°C)..... | 471mW/°C | Storage Temperature Range | -65°C to +160°C |
| 8-Pin μ MAX (derate 4.10mW/°C above +70°C)..... | 330mW/°C | Lead Temperature (soldering, 10s) | +300°C |

Stresses beyond those listed under "Absolute Maximum Ratings" may cause permanent damage to the device. These are stress ratings only, and functional operation of the device at these or any other conditions beyond those indicated in the operational sections of the specifications is not implied. Exposure to absolute maximum rating conditions for extended periods may affect device reliability.

Electrical Characteristics

($V_{CC} = +2.7V$ to $+5.5V$, $V_{CM} = 0V$, $C_{OUT} = 5pF$, $V_{SHDN} = 0V$, $V_{LE} = 0V$, unless otherwise noted. T_{MIN} to T_{MAX} is $-40^\circ C$ to $+85^\circ C$ for all E grade devices. For MAX999AAUK only, T_{MIN} to T_{MAX} is $-40^\circ C$ to $+125^\circ C$.) (Note 1)

| PARAMETER | SYMBOL | CONDITIONS | $T_A = +25^\circ C$ | | | T_{MIN} to T_{MAX} | | | UNITS |
|----------------------------------|------------|---|----------------------|-----------|----------------|------------------------|-----|----------------|------------|
| | | | MIN | TYP | MAX | MIN | TYP | MAX | |
| Supply Voltage | V_{CC} | Inferred by PSRR | 2.7 | | 5.5 | 2.7 | | 5.5 | V |
| Input Common-Mode Voltage Range | V_{CMR} | (Note 2) | -0.1 | | $V_{CC} + 0.1$ | -0.1 | | $V_{CC} + 0.1$ | V |
| Input-Referred Trip Points | V_{TRIP} | $V_{CM} = -0.1V$ or $5.1V$, $V_{CC} = 5V$ (Note 3) | μ MAX, SOT23 | ± 2.0 | ± 3.5 | | | ± 6.5 | mV |
| | | | MAX999AAUK | ± 2.0 | ± 3.5 | | | ± 8.0 | |
| | | | All other E packages | ± 2.0 | ± 3.5 | | | ± 4.0 | |
| Input-Referred Hysteresis | | | | 3.5 | | | | mV | |
| Input Offset Voltage | V_{OS} | $V_{CM} = -0.1V$ or $5.1V$, $V_{CC} = 5V$ (Note 4) | μ MAX, SOT23 | ± 0.5 | ± 1.5 | | | ± 4.5 | mV |
| | | | MAX999AAUK | ± 0.5 | ± 1.5 | | | ± 6.0 | |
| | | | All other E packages | ± 0.5 | ± 1.5 | | | ± 2.0 | |
| Input Bias Current | I_B | $V_{IN+} = V_{IN-} = 0V$ or V_{CC} , $V_{CC} = 5V$ | μ MAX, SOT23 | | ± 15 | | | ± 30 | μA |
| | | | All other E packages | | ± 15 | | | ± 15 | |
| Differential Input Clamp Voltage | | $V_{CC} = 5.5V$, $V_{IN-} = 0V$, $I_{IN+} = 100\mu A$ | | 2.1 | | | | | V |
| Input Capacitance | | | | 3 | | | | | pF |
| Differential Input Impedance | R_{IND} | $V_{CC} = 5V$ | | 8 | | | | | k Ω |
| Common-Mode Input Impedance | R_{INCM} | $V_{CC} = 5V$ | | 130 | | | | | k Ω |

MAX961–MAX964/
MAX997/MAX999

Single/Dual/Quad, Ultra-High-Speed, +3V/+5V,
Beyond-the-Rails Comparators

Electrical Characteristics (continued)

($V_{CC} = +2.7V$ to $+5.5V$, $V_{CM} = 0V$, $C_{OUT} = 5pF$, $V_{SHDN} = 0V$, $V_{LE} = 0V$, unless otherwise noted. T_{MIN} to T_{MAX} is $-40^{\circ}C$ to $+85^{\circ}C$ for all E grade devices. For MAX999AAUK only, T_{MIN} to T_{MAX} is $-40^{\circ}C$ to $+125^{\circ}C$.) (Note 1)

| PARAMETER | SYMBOL | CONDITIONS | | $T_A = +25^{\circ}C$ | | | T_{MIN} to T_{MAX} | | | UNITS |
|--|------------------|--|----------------------|----------------------|-----|------------------|------------------------|---------|------|-------|
| | | | | MIN | TYP | MAX | MIN | TYP | MAX | |
| Common-Mode Rejection Ratio | CMRR | $V_{CC} = 5V$, $V_{CM} = -0.1V$ to $5.1V$ (Note 5) | μ MAX, SOT23 | 0.1 | 0.3 | | | 1.0 | mV/V | |
| | | | All other E packages | 0.1 | 0.3 | | | 0.5 | | |
| Power-Supply Rejection Ratio | PSRR | $V_{CM} = 0V$ (Note 6) | | 0.05 | 0.3 | | | 0.3 | mV/V | |
| Output High Voltage | V_{OH} | $I_{SOURCE} = 4mA$ | E grade | $V_{CC} - 0.52$ | | $V_{CC} - 0.52$ | | V | | |
| | | | MAX999AAUK | $V_{CC} - 0.52$ | | $V_{CC} - 0.55$ | | | | |
| Output Low Voltage | V_{OL} | $I_{SINK} = 4mA$ | E grade | 0.52 | | 0.52 | | V | | |
| | | | MAX999AAUK | 0.52 | | 0.55 | | | | |
| Capacitive Slew Current | | $V_{OUT} = 1.4V$, $V_{CC} = 2.7V$ | | 30 | 60 | | | | mA | |
| Output Capacitance | | | | 4 | | | | | pF | |
| Supply Current per Comparator | I_{CC} | MAX961/MAX963, $V_{CC} = 5V$ | | 7.2 | 11 | 11 | | mA | | |
| | | MAX962/MAX964, $V_{CC} = 5V$ | | 5 | 8 | 9 | | | | |
| | | MAX997/MAX999E, $V_{CC} = 5V$ | | 5 | 6.5 | 6.5 | | | | |
| | | MAX999AAUK, $V_{CC} = 5V$ | | 5 | 6.5 | 7.0 | | | | |
| Shutdown Supply Current per Comparator | I_{SHDN} | MAX961/MAX963/MAX964/ MAX997, $V_{CC} = 5V$ | | 0.27 | 0.5 | 0.5 | | mA | | |
| Shutdown Output Leakage Current | | MAX961/MAX963/MAX964/ MAX997, $V_{OUT} = 5V$ and $V_{CC} - 5V$ | | 1 | | 20 | | μ A | | |
| Rise/Fall Time | t_R, t_F | $V_{CC} = 5V$ | | 2.3 | | | | ns | | |
| Logic-Input High | V_{IH} | | | $V_{CC}/2 + 0.4$ | | $V_{CC}/2 + 0.4$ | | V | | |
| Logic-Input Low | V_{IL} | | | $V_{CC}/2 - 0.4$ | | $V_{CC}/2 - 0.4$ | | V | | |
| Logic-Input Current | I_{IL}, I_{IH} | $V_{LOGIC} = 0V$ or V_{CC} | | ± 15 | | ± 30 | | μ A | | |
| Propagation Delay | t_{PD} | 5mV overdrive (Note 7) | E grade | 4.5 | 7.0 | 8.5 | | ns | | |
| | | | MAX999AAUK | 4.5 | 7.0 | 10 | | | | |
| Differential Propagation Delay | t_{PD} | Between any two channels or outputs (Q/\bar{Q}) | | 0.3 | | | | ns | | |
| Propagation-Delay Skew | t_{SKEW} | Between t_{PD-} and t_{PD+} | | 0.3 | | | | ns | | |

Electrical Characteristics (continued)

($V_{CC} = +2.7V$ to $+5.5V$, $V_{CM} = 0V$, $C_{OUT} = 5pF$, $V_{SHDN} = 0V$, $V_{LE} = 0V$, unless otherwise noted. T_{MIN} to T_{MAX} is $-40^{\circ}C$ to $+85^{\circ}C$ for all E grade devices. For MAX999AAUK only, T_{MIN} to T_{MAX} is $-40^{\circ}C$ to $+125^{\circ}C$.) (Note 1)

| PARAMETER | SYMBOL | CONDITIONS | $T_A = +25^{\circ}C$ | | | T_{MIN} to T_{MAX} | | | UNITS |
|--------------------------|-----------|--|----------------------|-----|-----|------------------------|-----|-----|-------|
| | | | MIN | TYP | MAX | MIN | TYP | MAX | |
| Data-to-Latch Setup Time | t_{SU} | MAX961/MAX963 (Note 8) | | | 5 | | | 5 | ns |
| Latch-to-Data Hold Time | t_H | MAX961/MAX963 (Note 8) | | | 5 | | | 5 | ns |
| Latch Pulse Width | t_{LPW} | MAX961/MAX963 (Note 8) | | | 5 | | | 5 | ns |
| Latch Propagation Delay | t_{LPD} | MAX961/MAX963 (Note 8) | | | 10 | | | 10 | ns |
| Shutdown Time | t_{OFF} | Delay until output is high-Z (> 10k Ω) | | 150 | | | | | ns |
| Shutdown Disable Time | t_{ON} | Delay until output is valid | | 250 | | | | | ns |

- Note 1:** The MAX961EUA/MAX962EUA/MAX997EUA/MAX999EUK are 100% production tested at $T_A = +25^{\circ}C$; all temperature specifications are guaranteed by design.
- Note 2:** Inferred by CMRR. Either input can be driven to the absolute maximum limit without false output inversion, provided that the other input is within the input voltage range.
- Note 3:** The input-referred trip points are the extremities of the differential input voltage required to make the comparator output change state. The difference between the upper and lower trip points is equal to the width of the input-referred hysteresis zone. (See Figure 1.)
- Note 4:** Input offset voltage is defined as the mean of the trip points.
- Note 5:** $CMRR = (V_{OSL} - V_{OSH}) / 5.2V$, where V_{OSL} is the offset at $V_{CM} = -0.1V$ and V_{OSH} is the offset at $V_{CM} = 5.1V$.
- Note 6:** $PSRR = (V_{OS2.7} - V_{OS5.5}) / 2.8V$, where $V_{OS2.7}$ is the offset voltage at $V_{CC} = 2.7V$, and $V_{OS5.5}$ is the offset voltage at $V_{CC} = 5.5V$.
- Note 7:** Propagation delay for these high-speed comparators is guaranteed by design characterization because it cannot be accurately measured using automatic test equipment. A statistically significant sample of devices is characterized with a 200mV step and 100mV overdrive over the full temperature range. Propagation delay can be guaranteed by this characterization, since DC tests ensure that all internal bias conditions are correct. For low overdrive conditions, V_{TRIP} is added to the overdrive.
- Note 8:** Guaranteed by design.

Typical Operating Characteristics

($V_{CC} = +3.0V$, $C_{LOAD} = 5pF$, 5mV of overdrive, $T_A = +25^\circ C$, unless otherwise noted.)

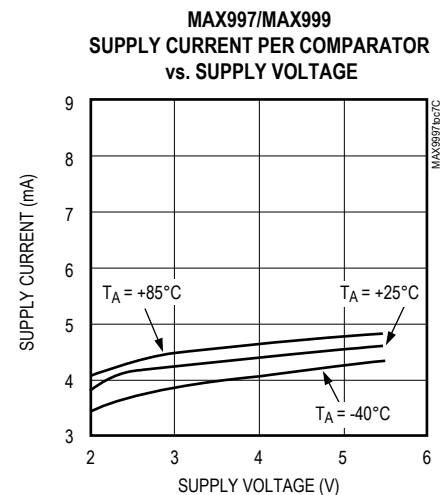
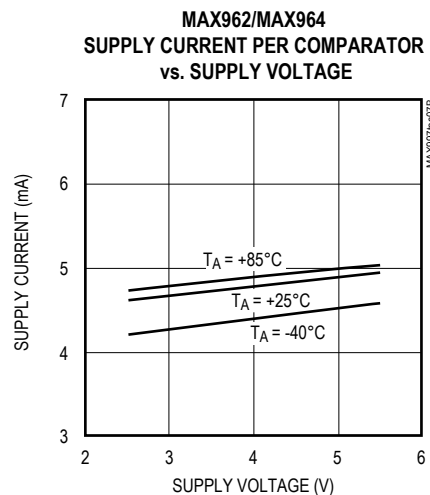
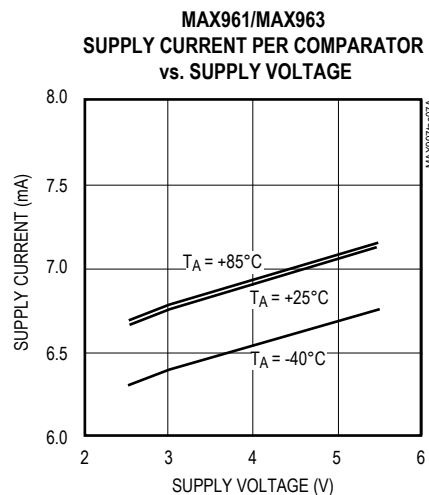
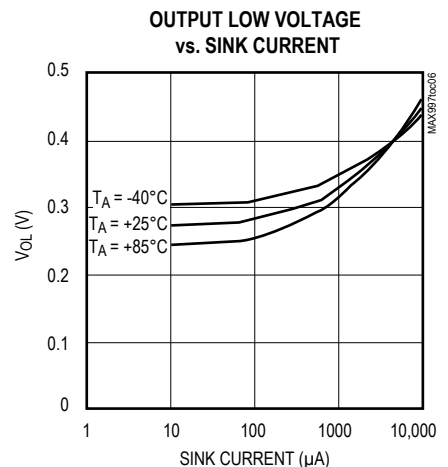
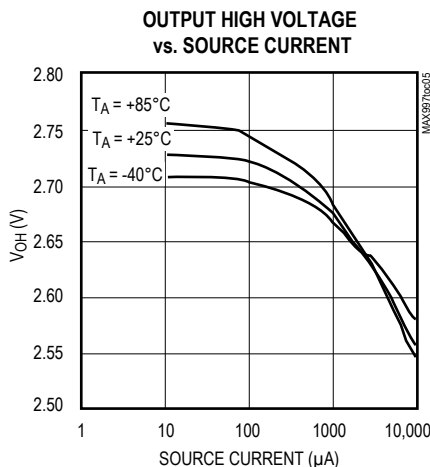
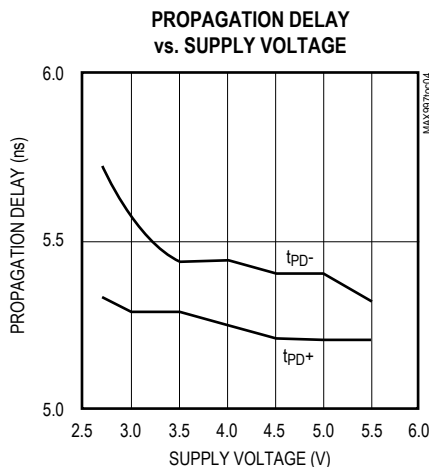
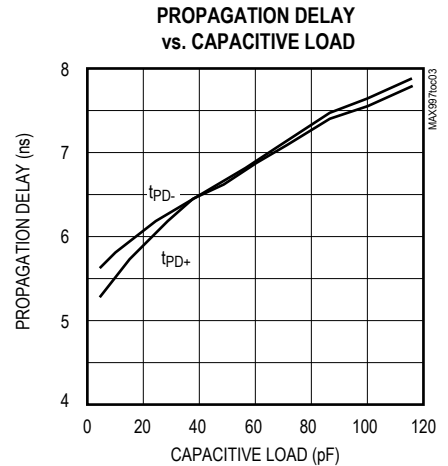
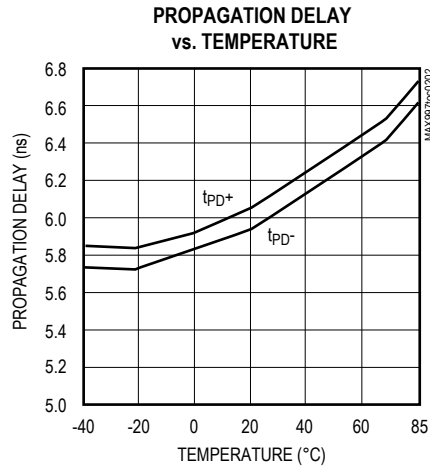
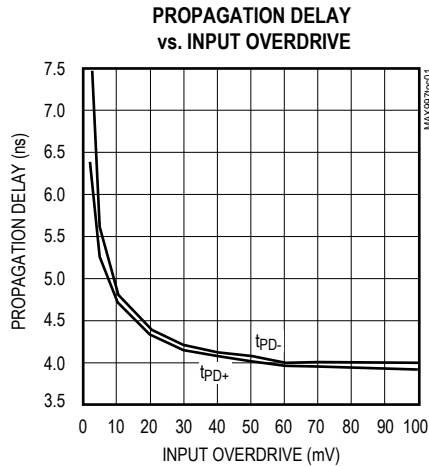

Typical Operating Characteristics (continued)

($V_{CC} = +3.0V$, $C_{LOAD} = 5pF$, 5mV of overdrive, $T_A = +25^\circ C$, unless otherwise noted.)

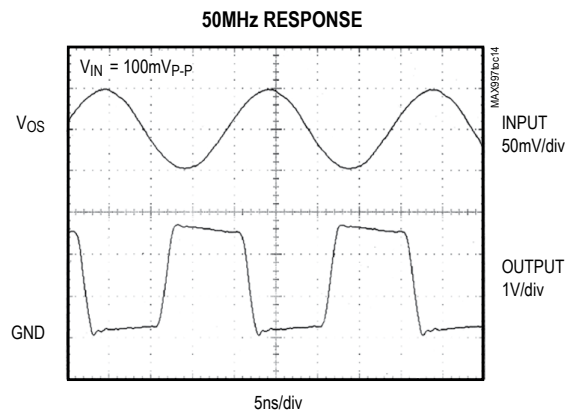
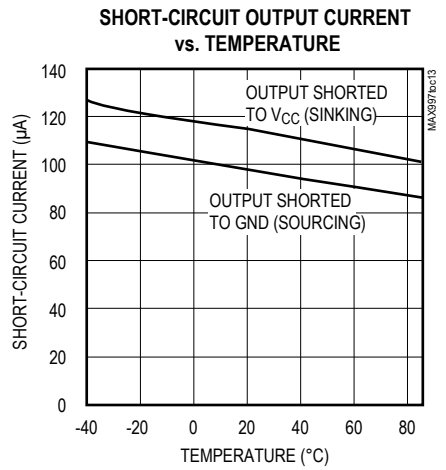
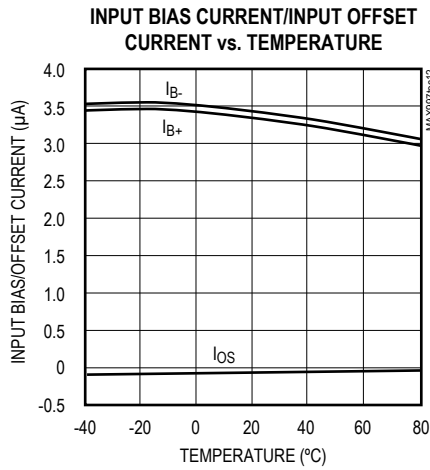
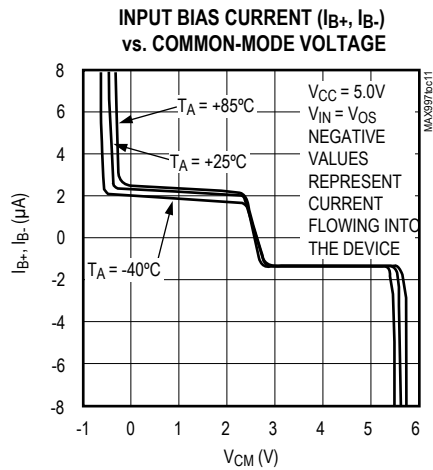
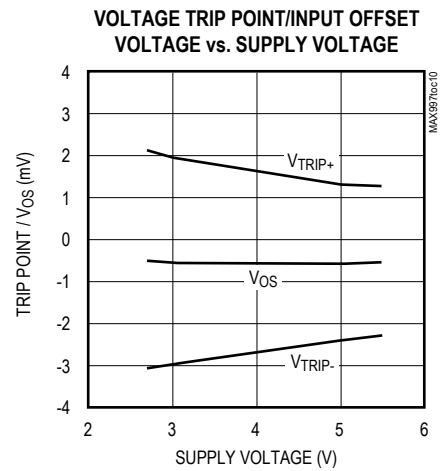
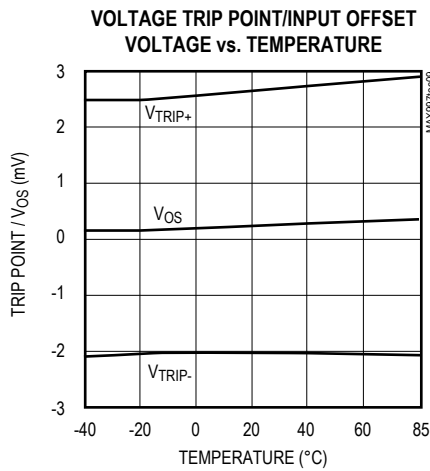
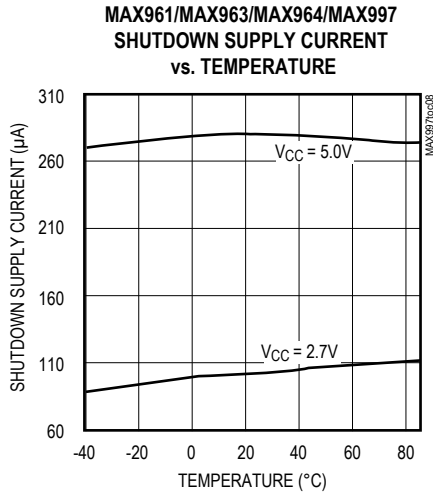

Typical Operating Characteristics (continued)

($V_{CC} = +3.0V$, $C_{LOAD} = 5pF$, 5mV of overdrive, $T_A = +25^\circ C$, unless otherwise noted.)

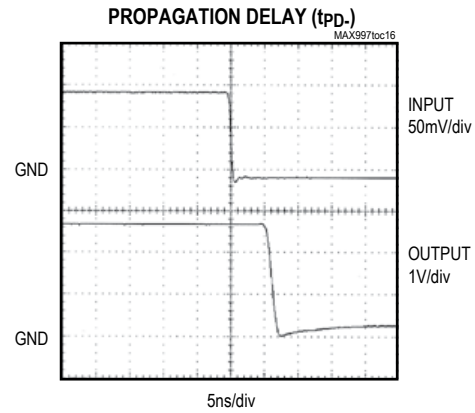
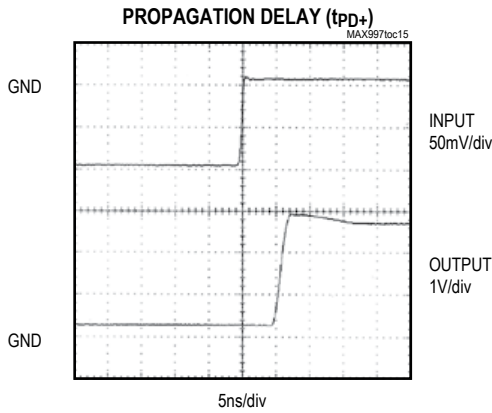

Pin Description

| PIN | | | | | | NAME | FUNCTION |
|--------|--------|--------|--------|--------|--------|-------------------------------|--|
| MAX997 | MAX999 | MAX961 | MAX962 | MAX963 | MAX964 | | |
| 1, 5 | — | — | — | — | — | N.C. | No Connection. Not internally connected. |
| 2 | 4 | 2 | 2 | 1 | 1 | IN-, INA- | Comparator A Inverting Input |
| 3 | 3 | 1 | 1 | 2 | 2 | IN+, INA+ | Comparator A Noninverting Input |
| — | — | 4 | — | 3, 5 | — | LE, LEA, LEB | Latch-Enable Input. The output latches when LE_ is high. The latch is transparent when LE_ is low. |
| 4 | 2 | 5 | 5 | 4, 11 | 12 | GND | Ground |
| — | — | — | — | — | 16 | N.C. | No Connection. Connect to GND to prevent parasitic feedback. |
| — | — | — | 4 | 6 | 3 | INB- | Comparator B Inverting Input |
| — | — | — | 3 | 7 | 4 | INB+ | Comparator B Noninverting Input |
| — | — | — | — | — | 5 | INC- | Comparator C Inverting Input |
| — | — | — | — | — | 6 | INC+ | Comparator C Noninverting Input |
| — | — | — | — | — | 7 | IND- | Comparator D Inverting Input |
| — | — | — | — | — | 8 | IND+ | Comparator D Noninverting Input |
| 8 | — | 3 | — | 8 | 9 | SHDN | Shutdown Input. The device shuts down when SHDN is high. |
| — | — | — | 6 | 9 | 14 | QB | Comparator B Output |
| — | — | — | — | — | 11 | QC | Comparator C Output |
| — | — | — | — | — | 10 | QD | Comparator D Output |
| — | — | — | — | 10 | — | \overline{QB} | Comparator B Complementary Output |
| 7 | 5 | 8 | 8 | 12 | 13 | V_{CC} | Positive Supply Input (V_{CC} to GND must be $\leq 5.5V$) |
| 6 | 1 | 6 | 7 | 13 | 15 | Q, QA | Comparator A TTL Output |
| — | — | 7 | — | 14 | — | $\overline{Q}, \overline{QA}$ | Comparator A Complementary Output |

Detailed Description

The MAX961–MAX964/MAX997/MAX999 single-supply comparators feature internal hysteresis, ultra-high-speed operation, and low power consumption. Their outputs are guaranteed to pull within 0.52V of either rail without external pullup or pulldown circuitry. Beyond-the-Rails input voltage range and low-voltage, single-supply operation make these devices ideal for portable equipment. These comparators all interface directly to CMOS logic.

Timing

Most high-speed comparators oscillate in the linear region because of noise or undesirable parasitic feedback. This can occur when the voltage on one input is close to or equal to the voltage on the other input. These devices have a small amount of internal hysteresis to counter parasitic effects and noise.

The added hysteresis of the MAX961–MAX964/MAX997/MAX999 creates two trip points: one for the rising input voltage and one for the falling input voltage (Figure 1). The difference between the trip points is the hysteresis. When the comparator's input voltages are equal, the hys-

teresis effectively causes one comparator input voltage to move quickly past the other, thus taking the input out of the region where oscillation occurs. Standard comparators require hysteresis to be added with external resistors. The fixed internal hysteresis eliminates these resistors.

The MAX961/MAX963 include internal latches that allow storage of comparison results. LE has a high input impedance. If LE is low, the latch is transparent (i.e., the comparator operates as though the latch is not present). The comparator's output state is stored when LE is pulled high. All timing constraints must be met when using the latch function (Figure 2).

Input Stage Circuitry

The MAX961–MAX964/MAX997/MAX999 include internal protection circuitry that prevents damage to the precision input stage from large differential input voltages. This protection circuitry consists of two groups of three front-to-back diodes between IN+ and IN-, as well as two 200Ω resistors (Figure 3). The diodes limit the differential voltage applied to the comparator's internal circuitry to no more than $3V_F$, where V_F is the diode's forward-voltage drop (about 0.7V at +25°C).

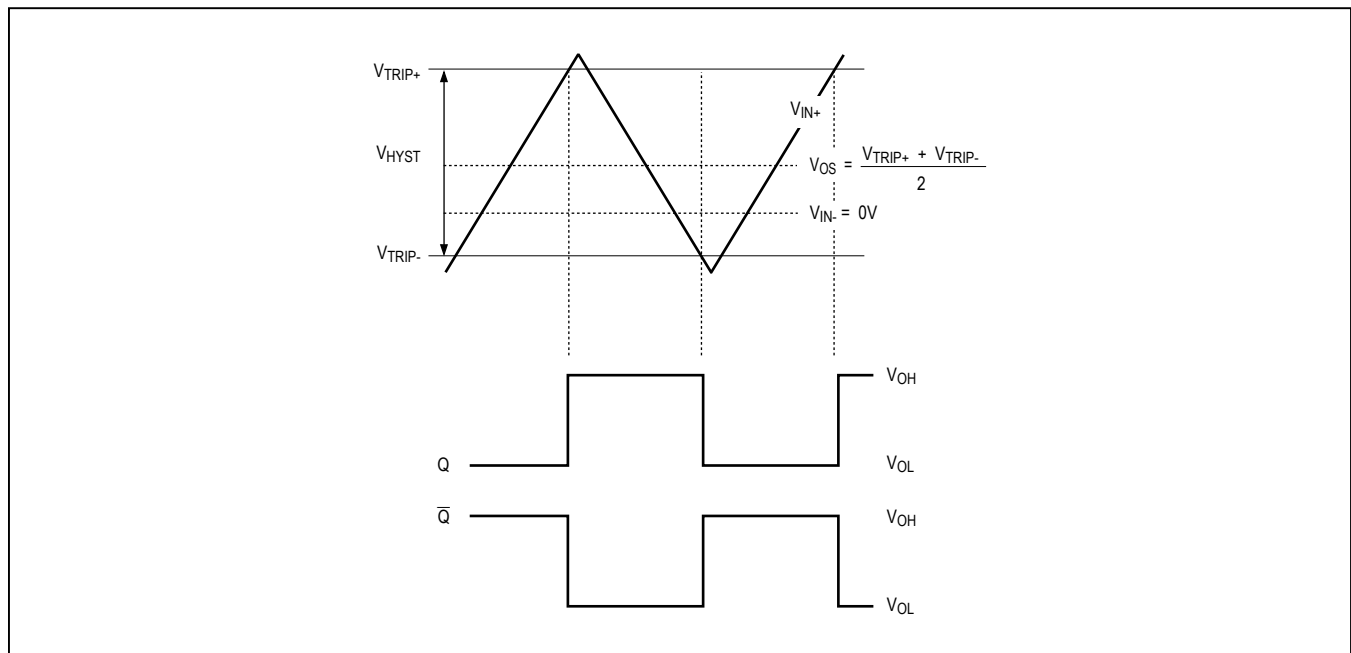

Figure 1. Input and Output Waveforms, Noninverting Input Varied

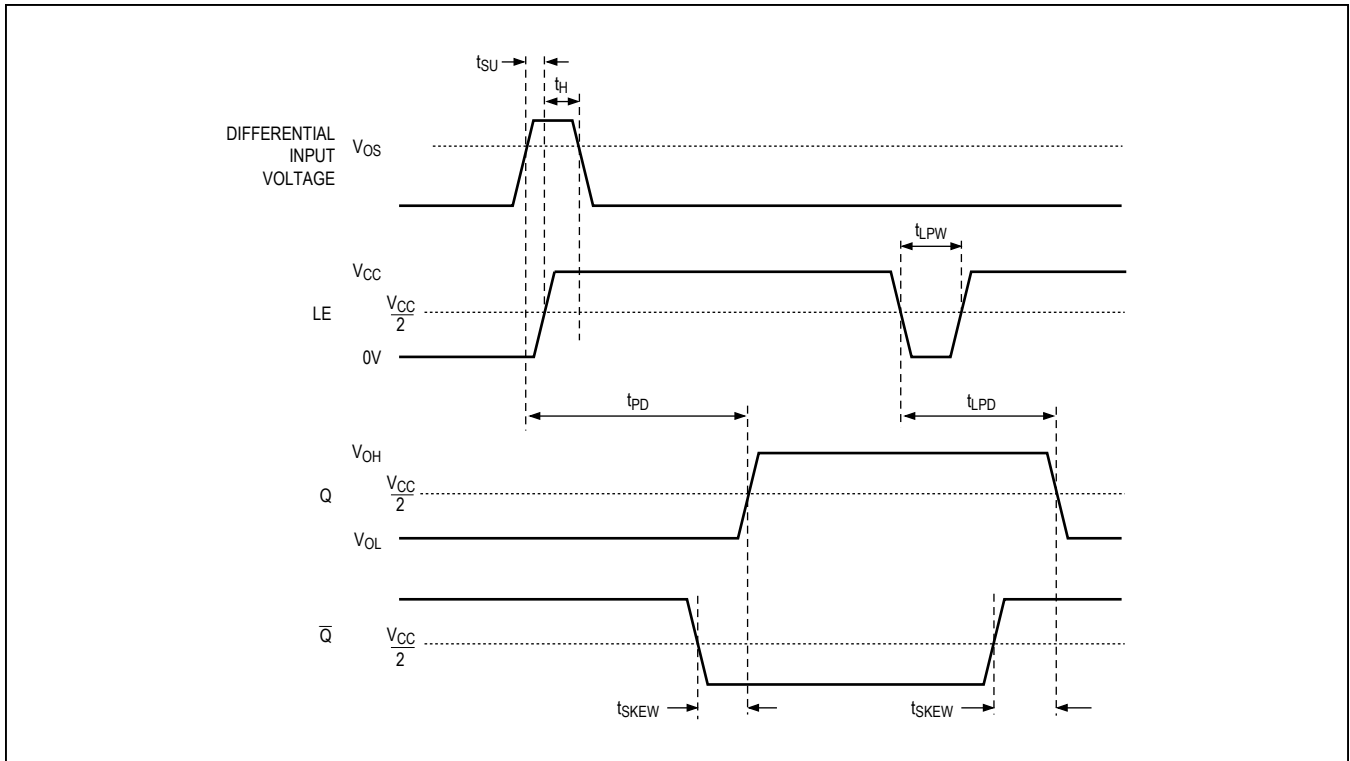

Figure 2. MAX961/MAX963 Timing Diagram

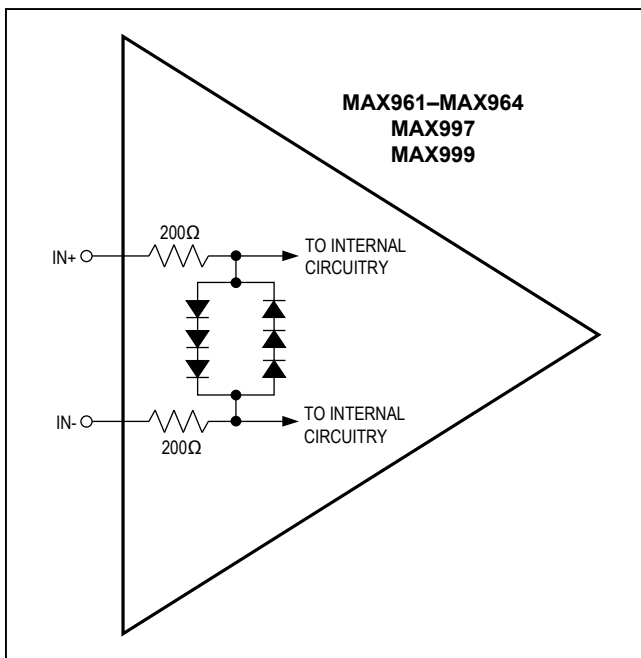

Figure 3. Input Stage Circuitry

For a large differential input voltage (exceeding $3V_F$), this protection circuitry increases the input bias current at $IN+$ (source) and $IN-$ (sink).

$$\text{Input current} = \frac{(IN+ - IN-) - 3V_F}{2 \times 200}$$

Input currents with large differential input voltages should not be confused with input bias currents (I_B). As long as the differential input voltage is less than $3V_F$, this input current is less than $2I_B$.

The input circuitry allows the MAX961–MAX964/MAX997/MAX999's input common-mode range to extend 100mV beyond both power-supply rails. The output remains in the correct logic state if one or both inputs are within the common-mode range. Taking either input outside the common-mode range causes the input to saturate and the propagation delay to increase.

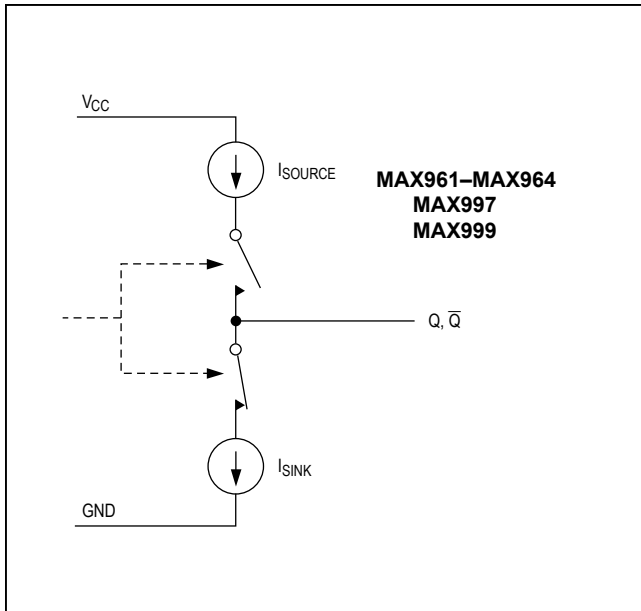

Figure 4. Output Stage Circuitry

Output Stage Circuitry

The MAX961–MAX964/MAX997/MAX999 contain a current-driven output stage, as shown in Figure 4. During an output transition, I_{SOURCE} or I_{SINK} is pushed or pulled to the output pin. The output source or sink current is high during the transition, creating a rapid slew rate. Once the output voltage reaches V_{OH} or V_{OL} , the source or sink current decreases to a small value, capable of maintaining the V_{OH} or V_{OL} in static condition. This decrease in current conserves power after an output transition has occurred.

One consequence of a current-driven output stage is a linear dependence between the slew rate and the load capacitance. A heavy capacitive load slows down the voltage output transition.

Shutdown Mode

When SHDN is high, the MAX961/MAX963/MAX964/MAX997 shut down. When shut down, the supply current drops to 270 μ A per comparator, and the outputs become high impedance. SHDN has a high input impedance. Connect SHDN to GND for normal operation. Exit shutdown with LE low; otherwise, the output is indeterminate.

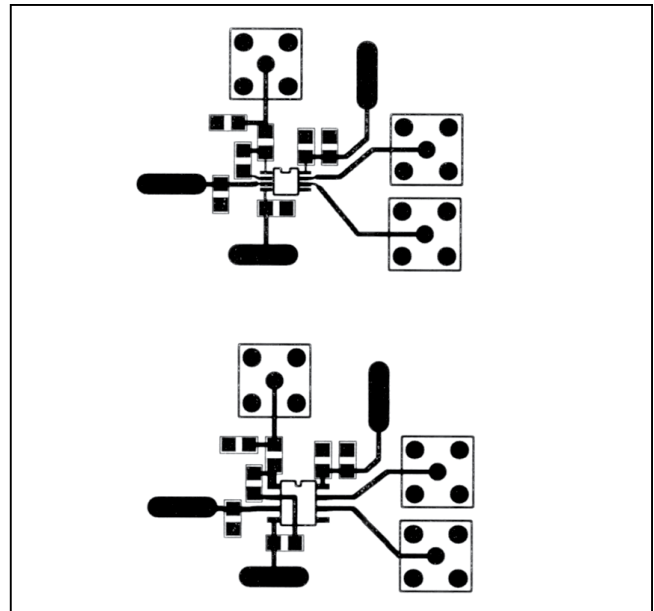

Figure 5. MAX961 PCB Layout

Applications Information

Circuit Layout and Bypassing

The MAX961–MAX964/MAX997/MAX999's high bandwidth requires a high-speed layout. Follow these layout guidelines:

- 1) Use a PCB with a good, unbroken, low-inductance ground plane.
- 2) Place a decoupling capacitor (a 0.1 μ F ceramic surface-mount capacitor is a good choice) as close to V_{CC} as possible.
- 3) On the inputs and outputs, keep lead lengths short to avoid unwanted parasitic feedback around the comparators. Keep inputs away from outputs. Keep impedance between the inputs low.
- 4) Solder the device directly to the printed circuit board rather than using a socket.
- 5) Refer to Figure 5 for a recommended circuit layout.
- 6) For slow-moving input signals, take care to prevent parasitic feedback. A small capacitor (1000pF or less) placed between the inputs can help eliminate oscillations in the transition region. This capacitor causes negligible degradation to t_{PD} when the source impedance is low.

Pin Configurations

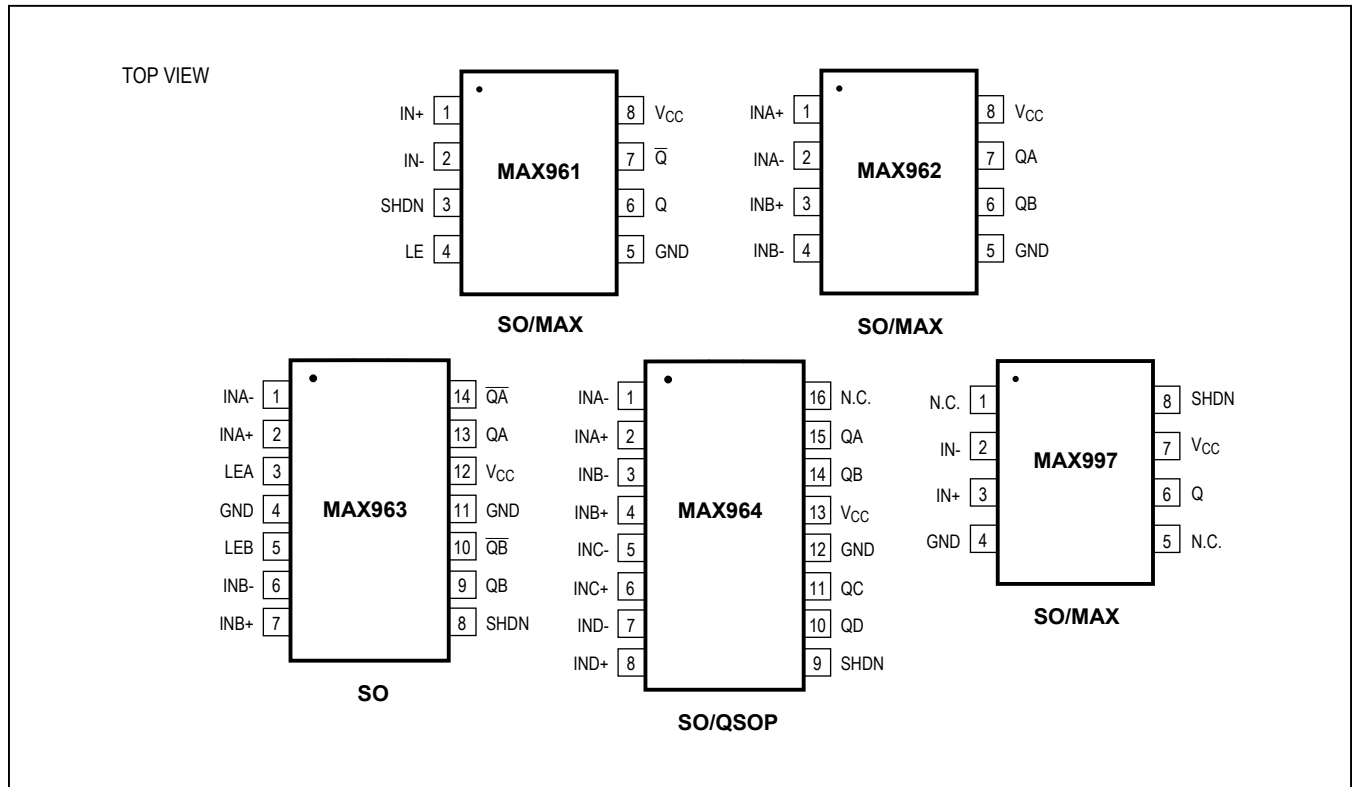

Chip Information

MAX961/MAX962 TRANSISTOR COUNT: 286

MAX963/MAX964 TRANSISTOR COUNT: 607

MAX997/MAX999 TRANSISTOR COUNT: 142

MAX961–MAX964/
MAX997/MAX999

Single/Dual/Quad, Ultra-High-Speed, +3V/+5V,
Beyond-the-Rails Comparators

Package Information

For the latest package outline information and land patterns (footprints), go to www.maximintegrated.com/packages. Note that a "+", "#", or "-" in the package code indicates RoHS status only. Package drawings may show a different suffix character, but the drawing pertains to the package regardless of RoHS status.

| PACKAGE TYPE | PACKAGE CODE | DOCUMENT NO. | LAND PATTERN NO. |
|--------------|--------------|-------------------------|-------------------------|
| 5 SOT23 | U5+1 | 21-0057 | 90-0174 |
| 8 SO | S8-2 | 21-0041 | 90-0096 |
| 8 μ MAX | U8-1 | 21-0036 | 90-0092 |
| 14 SO | S14-1 | 21-0041 | 90-0112 |
| 16 SO | S16-1 | 21-0041 | 90-0097 |
| 16 QSOP | E16-1 | 21-0055 | 90-0167 |

Revision History

| REVISION NUMBER | REVISION DATE | DESCRIPTION | PAGES CHANGED |
|-----------------|---------------|---|---------------|
| 0 | 9/96 | Initial release | — |
| 1 | 12/96 | Added 8-pin μ MAX packages. Correct minor errors. | 1, 2, 3 |
| 2 | 3/97 | Added dual and quad MAX963/MAX964 packages. | 1, 2, 3 |
| 3 | 7/97 | Added new MAX997 and MAX999 parts. | 1, 2, 3 |
| 4 | 3/99 | New wafer fab/process change to CB20. Update specifications and TOCs. | 2, 3, 4, 5, 6 |
| 5 | 2/07 | Added new Current into Input Pins in the <i>Absolute Maximum</i> Ratings. | 2 |
| 6 | 12/08 | Added new MAX999AAUK part and specifications. | 1, 2, 3 |
| 7 | 9/14 | Removed automotive reference from Revision History. | 13 |

For pricing, delivery, and ordering information, please contact Maxim Direct at 1-888-629-4642, or visit Maxim Integrated's website at www.maximintegrated.com.

Maxim Integrated cannot assume responsibility for use of any circuitry other than circuitry entirely embodied in a Maxim Integrated product. No circuit patent licenses are implied. Maxim Integrated reserves the right to change the circuitry and specifications without notice at any time. The parametric values (min and max limits) shown in the Electrical Characteristics table are guaranteed. Other parametric values quoted in this data sheet are provided for guidance.

Looking for pricing, stock, or lifecycle information?

Click below to explore more details on WIN SOURCE:

 [View MAX963ESD+](#) on WIN SOURCE

 [Maxim Integrated](#) Information

Optimize Your Supply Chain with WIN SOURCE Solutions

-  Global Sourcing Solution
-  Obsolete Management
-  Cost Control Management
-  Shortage Management
-  Alternative Solution
-  Excess Inventory Management