



**THE DATASHEET OF
MAX8214ACPE+**





Five Universal Voltage Monitors - Complete Microprocessor Voltage Monitoring

General Description

The MAX8213 and MAX8214 contain four precision voltage comparators capable of monitoring undervoltage and overvoltage conditions for both positive and negative supplies. Accurate trip-point setting is facilitated by the internal 1.25V reference. Not only is trip-level accuracy guaranteed to $\pm 1\%$ over the commercial temperature range, but the trip levels of all channels are guaranteed to match each other within $\pm 1\%$. A fifth comparator channel monitors microprocessor voltages and generates delayed reset signals. The MAX8213 has open-drain outputs, while active pull-up outputs are incorporated in the MAX8214.

Applications

- Microprocessor Voltage Monitoring
- Precision Battery Monitoring
- Over/Under/Window Voltage Detection
- Industrial Controllers
- Appliances
- Telephones
- Portable Computers
- Mobile Radios
- Portable Instruments
- Automotive and Industrial Equipment

Pin Configuration

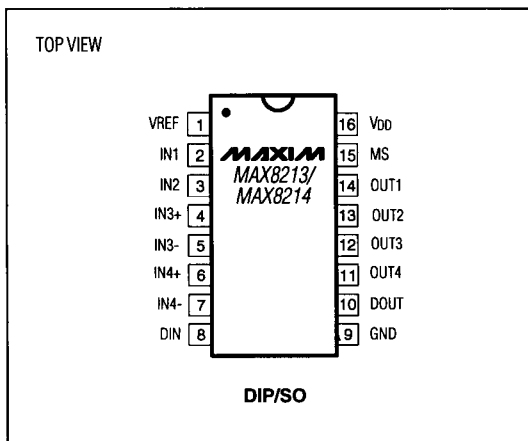

Features

- ◆ $\pm 1\%$ Guaranteed Trip-Level Accuracy over Commercial Temp. Range
- ◆ 4 Precision Comparators Plus Auxiliary Comparator
- ◆ Built-In Hysteresis
- ◆ Internal 1.25V Reference with 0.75% Initial Accuracy
- ◆ $\pm 1\%$ Guaranteed Trip-Level Matching Between Channels over Commercial Temp. Range
- ◆ Wide Supply Range: 2.7V to 11V
- ◆ Controlled Comparator Response for Glitch Immunity
- ◆ 33 μ A Max Supply Current Over Temp.

Ordering Information

PART	TEMP. RANGE	PIN-PACKAGE
MAX8213ACPE	0°C to +70°C	16 Plastic DIP
MAX8213BCPE	0°C to +70°C	16 Plastic DIP

Ordering information continued on last page.

Typical Operating Circuit

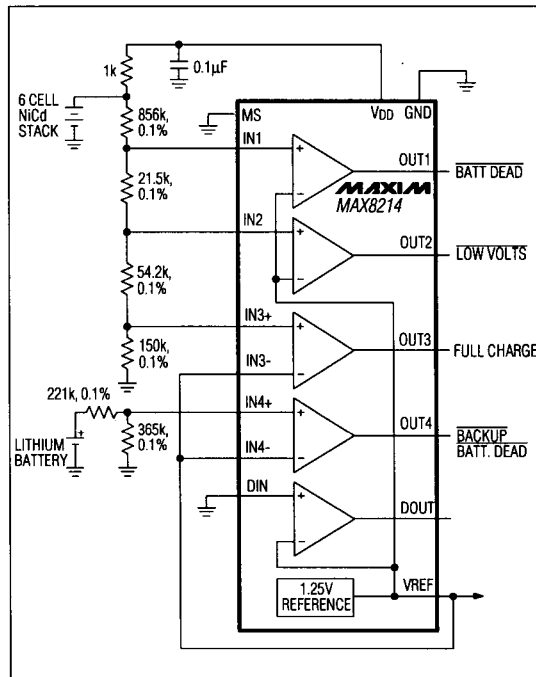

MAX8213/MAX8214



Maxim Integrated Products

Call toll free 1-800-998-8800 for free samples or literature.

Five Universal Voltage Monitors – Complete Microprocessor Voltage Monitoring

ABSOLUTE MAXIMUM RATINGS

V _{DD} to GND -0.3V, +12V
Digital Input Voltage to GND -0.3V, (V _{DD} + 0.3V)
V _{REF} to GND -0.3V, (V _{DD} + 0.3V)
V _{OUT} to GND -0.3V, (V _{DD} + 0.3V)
Continuous Power Dissipation (T _A = +70°C)	
Plastic DIP (derate 10.53mW/°C above +70°C) 842mW
SO (derate 8.70mW/°C above +70°C) 696mW
CERDIP (derate 10.00mW/°C above +70°C) 800mW

Operating Temperature Ranges:

MAX821__C__ 0°C to +70°C
MAX821__E__ -40°C to +85°C
MAX821__MJE -55°C to +125°C
Storage Temperature Range -65°C to +165°C
Lead Temperature (soldering, 10sec) +300°C

Stresses beyond those listed under "Absolute Maximum Ratings" may cause permanent damage to the device. These are stress ratings only, and functional operation of the device at these or any other conditions beyond those indicated in the operational sections of the specifications is not implied. Exposure to absolute maximum rating conditions for extended periods may affect device reliability.

ELECTRICAL CHARACTERISTICS

(V_{DD} = 5V, GND = 0V, T_A = +25°C, unless otherwise noted.)

PARAMETER	CONDITIONS		MIN	TYP	MAX	UNITS	
POWER SUPPLY							
Positive Supply Voltage Range (Note 1)	T _A = T _{MIN} to T _{MAX}	MAX821__C__	2.7		11	V	
		MAX821__E__, MAX821__M	2.85		11		
Positive Supply Current	T _A = T _{MIN} to T _{MAX}			16	33	μA	
REFERENCE OUTPUT							
Reference Variation Referred to 1.25V	T _A = +25°C	MAX821_A	-0.75		0.75	%	
		MAX821_B	-1.50		1.50		
	T _A = T _{MIN} to T _{MAX}	MAX821_AC	-1.00		1.00		
		MAX821_BC	-2.00		2.00		
		MAX821_AE	-1.25		1.25		
		MAX821_BE	-2.50		2.50		
		MAX821_AM	-1.50		1.50		
		MAX821_BM	-3.00		3.00		
Reference Load	T _A = T _{MIN} to T _{MAX}				40	μA	
Load Regulation			10			μV/μA	
Line Regulation			0.005			%/V	
Output Tempco				15		ppm/°C	
COMPARATOR INPUTS							
Comparators IN1-IN4 Trip Level with Respect to 1.25V (Note 2)	T _A = +25°C	V _{IN} decreasing	T _A = T _{MIN} to T _{MAX}	MAX821_A	-0.90	0.90	%
				MAX821_B	-1.50	1.50	
				MAX821_AC	-1.00	1.00	
	MAX821_BC			-2.00	2.00		
	MAX821_AE			-1.25	1.25		
	MAX821_BE			-2.50	2.50		
	MAX821_AM			-1.50	1.50		
	MAX821_BM			-3.00	3.00		

Five Universal Voltage Monitors – Complete Microprocessor Voltage Monitoring

MAX8213/MAX8214

ELECTRICAL CHARACTERISTICS (continued)

(V_{DD} = 5V, GND = 0V, T_A = +25°C, unless otherwise noted.)

PARAMETER	CONDITIONS		MIN	TYP	MAX	UNITS	
Comparators IN2-IN4 Trip Level with Respect to Trip Level of IN1	V _{IN} decreasing	T _A = T _{MIN} to T _{MAX}	MAX821_AC	-1.00		1.00	%
			MAX821_BC	-2.00		2.00	
			MAX821_AE	-1.25		1.25	
			MAX821_BE	-2.50		2.50	
			MAX821_AM	-1.50		1.50	
			MAX821_BM	-2.50		2.50	
Comparator DIN Trip Level with Respect to 1.25V	V _{IN} decreasing	T _A = +25°C	MAX821_A	-1.5		1.5	%
			MAX821_B	-2.5		2.5	
		T _A = T _{MIN} to T _{MAX}	MAX821_AC	-2.0		2.0	
			MAX821_BC	-3.0		3.0	
			MAX821_AE	-2.5		2.5	
			MAX821_BE	-3.0		3.0	
			MAX821_AM	-3.0		3.0	
			MAX821_BM	-3.5		3.5	
Comparators IN1-IN4, DIN Threshold Hysteresis			11	17	23	mV	
Hysteresis Tempco				30		μV/°C	
Input Bias Current				1.5	10	nA	
Input Voltage Change for Complete Output Change				0.1		mV	
Input Common-Mode Range	IN3, IN4 (Note 3)	upper limit		V _{DD} - 2V _{BE}		V	
		lower limit		0			
COMPARATOR OUTPUTS							
Voltage Output Low	T _A = T _{MIN} to T _{MAX}	V _{DD} = 5V, I _{SINK} = 2mA		0.11	0.30	V	
		V _{DD} = 5V, I _{SINK} = 5mA		0.28	0.75		
		V _{DD} = 1.5V, I _{SINK} = 0.2mA		0.04	0.30		
		V _{DD} = 1.0V, I _{SINK} = 0.1mA		0.10			
Voltage Output High	V _{DD} = 5V; I _{SOURCE} = 1mA (MAX8214)		V _{DD} - 0.4	V _{DD} - 0.15		V	
Leakage Current	Off state (MAX8213)				1.0	μA	
MODE SELECT INPUT							
Leakage Current					1.0	μA	
DYNAMIC SPECIFICATIONS							
Comparator Response Time	30mV overdrive			20		μs	

Note 1: For lower voltage range operation, see Figure 22.

Note 2: Each of the comparators has one input tied to VREF.

Note 3: V_{BE} equals approximately 0.65V at +25°C. The temperature coefficient of V_{BE} equals approximately -2.2mV/°C.

Five Universal Voltage Monitors – Complete Microprocessor Voltage Monitoring

Typical Operating Characteristics

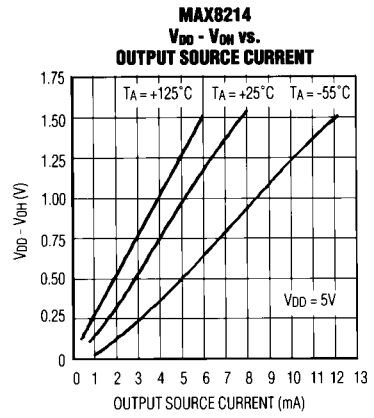
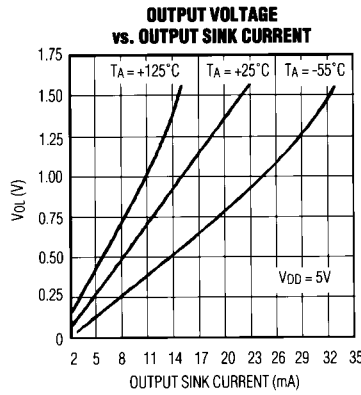
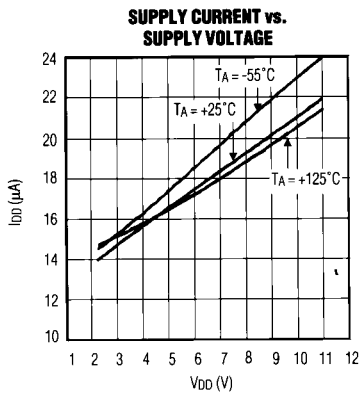
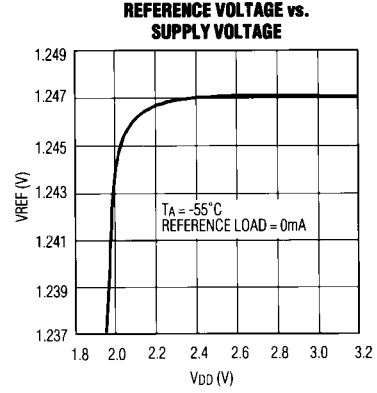
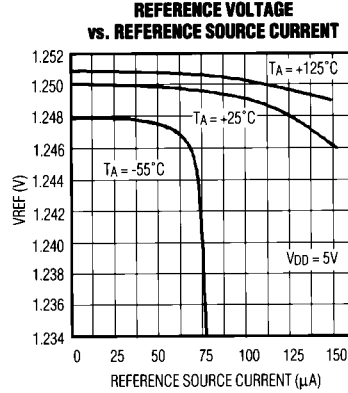
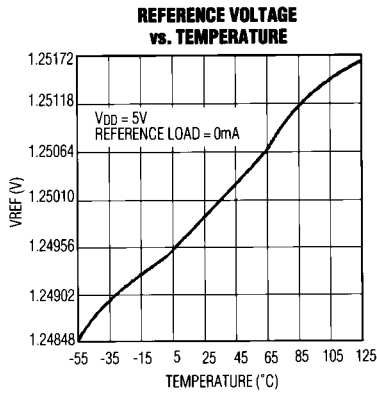
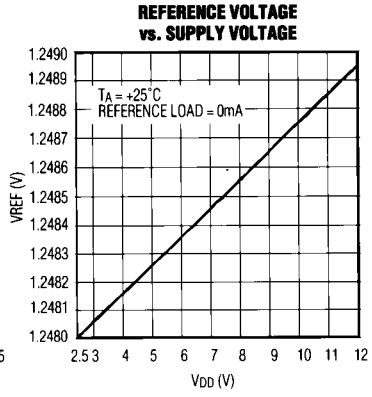
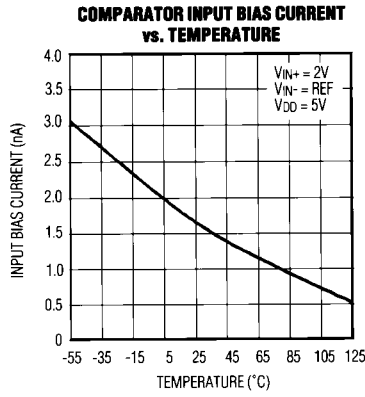
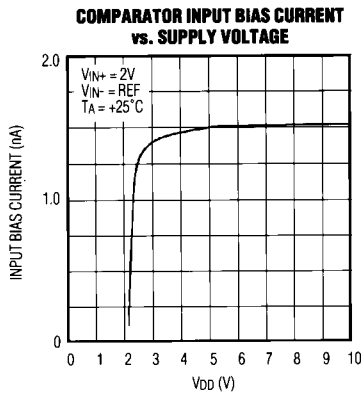

Five Universal Voltage Monitors – Complete Microprocessor Voltage Monitoring

Typical Operating Characteristics (continued)

MAX8213/MAX8214

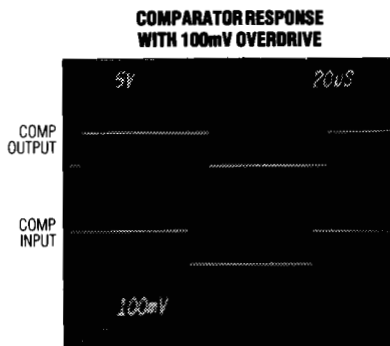
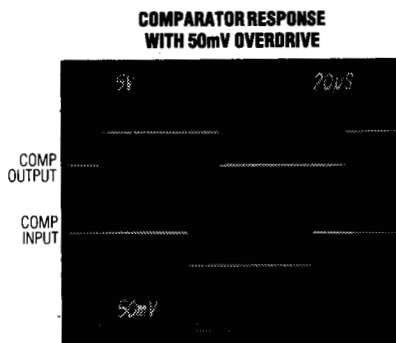
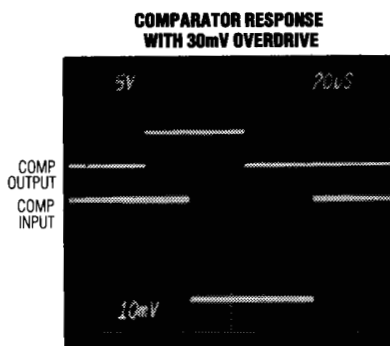
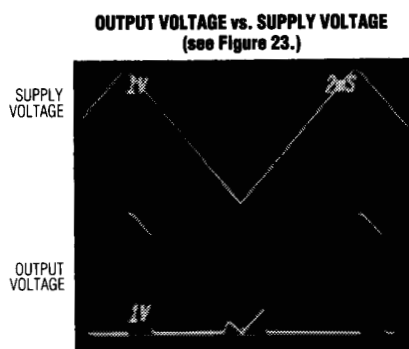

Pin Description

PIN	NAME	FUNCTION
1	VREF	Output of the Internal 1.25V Reference
2, 3	IN1, IN2	Noninverting Inputs of Comparators 1 and 2. The inverting inputs of these comparators are tied to the internal reference.
4, 6	IN3+, IN4+	Noninverting Inputs of Comparators 3 and 4. The inverting inputs of these comparators are available external to the device.
5, 7	IN3-, IN4-	Inverting Inputs of Comparators 3 and 4
8	DIN	Noninverting Input of the Auxiliary Comparator. The trip-level accuracy of this comparator is less than that of the other four comparators; otherwise it is identical. Its inverting input is tied to the internal reference.
9	GND	Power-Supply Ground

Five Universal Voltage Monitors – Complete Microprocessor Voltage Monitoring

Pin Description (continued)

PIN	NAME	FUNCTION
10	DOUT	Output of the Auxiliary Comparator
11, 12, 13, 14	OUT4, OUT3, OUT2, OUT1	Outputs of the Four High-Accuracy Comparators
15	MS	Mode Select. Input determining the polarity of the signal appearing at OUT1 and OUT2. A high level inverts the comparator outputs, whereas a low level does not. Connecting MS to VREF causes OUT2 to be inverted, while OUT1 is not.
16	VDD	Power-Supply Positive Voltage Input

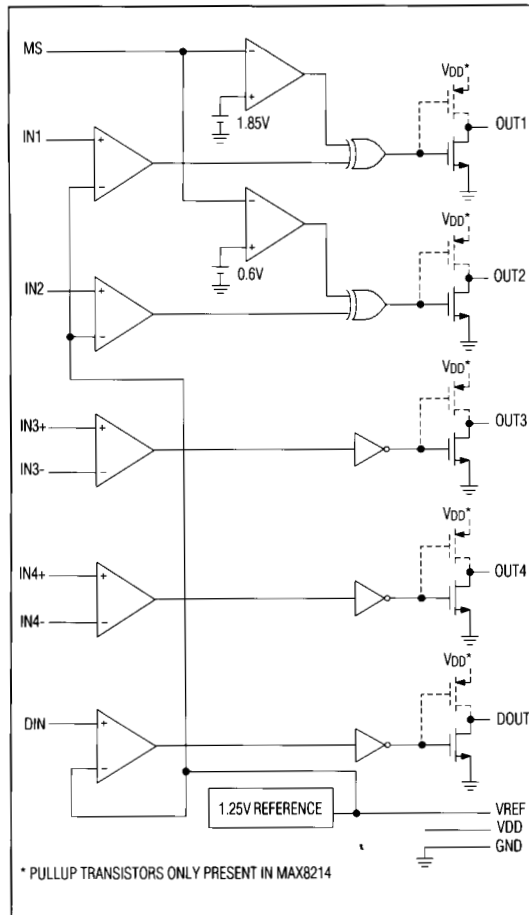

Figure 1. MAX8213/MAX8214 Block Diagram

Detailed Description

Block Diagram

The MAX8213/MAX8214 contain five comparators. The comparator with its output labeled DOUT is distinguished from the other four in that its trip point is not as accurate. The inverting inputs of this comparator, as well as those of comparators 1 and 2, are connected to the internal 1.25V reference (see Figure 1). Both inputs of comparators 3 and 4 are available external to these devices, allowing threshold levels to be set by the user at either the inverting or noninverting inputs.

The MAX8213's comparators have open-drain outputs, and the outputs of the MAX8214 are actively driven both high and low: this is the only difference between the two devices. Thus the MAX8213 is suitable for driving LEDs or for circuits where the outputs need to be wire-ORed (see the *Typical Applications* section). Among other applications, the MAX8214 comparator outputs are useful for driving both TTL and CMOS digital circuitry.

The Mode Select (MS) pin determines the polarity of OUT1 and OUT2. Table 1 shows the state of the comparator outputs in the three possible modes of operation when the noninverting input voltage exceeds that of the inverting input. If the inverting input exceeds the noninverting input, then invert the outputs shown in the table.

When operating in the mode where MS is connected to the VREF pin, OUT1 is not inverted, while OUT2 is inverted. This mode of operation is useful when constructing window comparator circuits (see the *Typical Applications* section).

Basic Overvoltage and Undervoltage Detection Circuits

When the voltage on one comparator input is at or near the voltage on the other input, ambient noise generally causes the comparator output to oscillate. The most common way to eliminate this problem is through hysteresis. When the two comparator input voltages are equal, hysteresis causes one comparator input voltage to move quickly past

Five Universal Voltage Monitors – Complete Microprocessor Voltage Monitoring

MAX8213/MAX8214

TABLE 1. MAX8213/MAX8214 Comparator Outputs when Noninverting Input Exceeds Inverting Input

MS	OUT1	OUT2	OUT3	OUT4	DOUT
LOW	1	1	1	1	1
HIGH	0	0	1	1	1
VREF	1	0	1	1	1

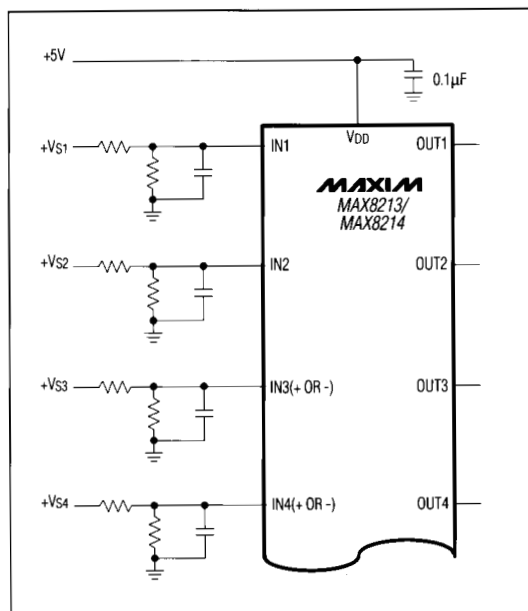

Figure 2. Alternative Means for Reducing Impedance Level Seen at Inputs

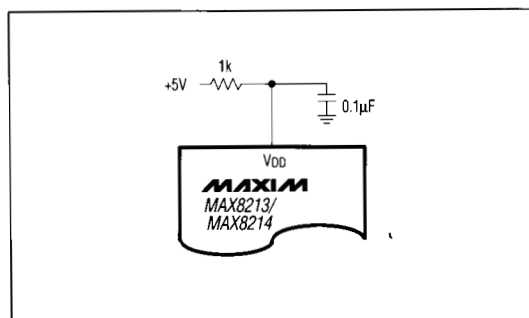

Figure 3. Additional Supply-Voltage Filtering

the other, thus taking the input out of the region where oscillation occurs. Standard comparators require that hysteresis be added through the use of external resistors; these resistors are not necessary when using the MAX8213 and MAX8214 because hysteresis is built into these devices.

The addition of hysteresis to a comparator creates two trip points, one for the input voltage rising and one for the input voltage falling. When the voltage at a MAX8213/ MAX8214 **noninverting** input falls, the threshold at which the comparator switches equals the voltage on the comparator's inverting input. However, when the voltage at the noninverting input rises, the threshold equals the voltage at the inverting input **plus** the amount of hysteresis voltage built into the part. The trip point is somewhat more accurate when the hysteresis voltage is not part of the threshold voltage, because the tolerance of the hysteresis specification adds to that of the trip point (and to the tolerance of the reference, if used). If a comparator's **Inverting** input is used to monitor a signal, then, when the input voltage falls, the threshold equals the voltage on the noninverting input **minus** the hysteresis voltage; when the input voltage rises, the threshold simply equals the voltage on the noninverting input.

One input of each comparator must be within the Input Common-Mode Range (see the *Electrical Characteristics*) when a comparison is made (i.e., the threshold voltage must be within this range). Any voltage is allowable on the other input prior to the comparison, as long as this voltage does not violate the input absolute maximum rating. Only comparators 3 and 4 are specified for this parameter because the threshold level of the other comparators is preset to the internal reference voltage.

Immunity to high-speed glitches has been provided by controlling the response time of the comparators. The 5µs to 20µs response time ensures that very fast glitches are ignored.

Application Hints

Eliminating Output Oscillation

Although hysteresis is built into these devices, output oscillation problems are still possible. One way these problems occur is when the output of a comparator couples back to its inverting input through stray board capacitance. Make sure the board trace leading from a comparator output does not pass near its inverting input (or vice versa). Also, reducing the amount of resistance connected to the comparator inputs reduces the susceptibility of the inputs to picking up output signals. In most cases, using input resistor values on the order of 100kΩ creates no problem. Since use of lower resistor values increases the supply current, another approach is to bypass the input resistors as shown in Figure 2, although this slows the circuit's response.

Five Universal Voltage Monitors – Complete Microprocessor Voltage Monitoring

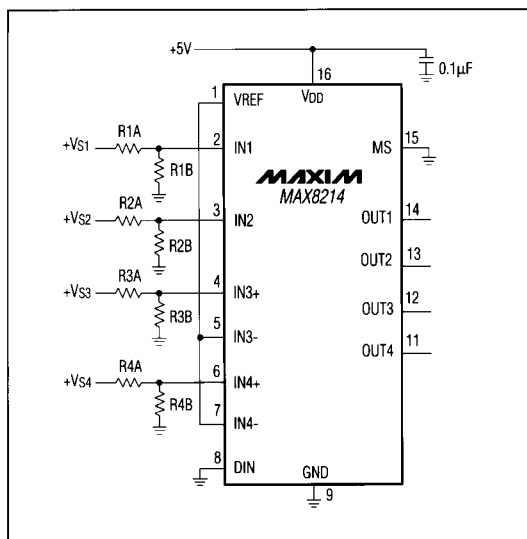

Figure 4. Quad Undervoltage Detector

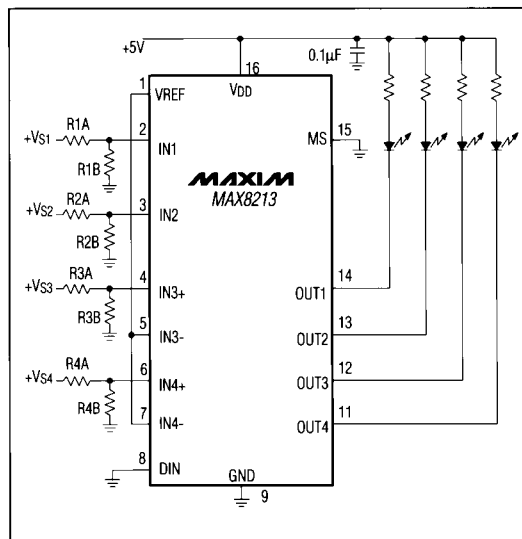

Figure 5. Quad Undervoltage Detector with LED Indicators

Oscillation problems can also occur due to brief reference-voltage variation caused by abrupt supply-voltage changes. At minimum, a 0.1µF supply bypass capacitor should be used. This bypassing can be supplemented by adding a 1kΩ resistor (or larger if necessary, bearing in mind the device supply current) as pictured in Figure 3. When the voltage supplying the part is also the one being monitored, this 1kΩ resistor is sometimes required. See the section *Monitoring the Voltage Powering the MAX8213/MAX8214*. In addition to decoupling the power supply, bypass VREF to GND if supply-voltage variations are severe. The optimal bypass value typically lies between 0.01µF to 1µF.

When the MAX8213 is required to sink larger currents (i.e., when smaller value pull-up resistors are used), oscillation problems are more likely to occur. To minimize power consumption and optimize stability, use the largest value pull-up resistor feasible for the output drive required. When lower value pull-up resistors are used, lower values for the resistors connected to the inputs can help alleviate oscillation problems.

Unused Inputs

When comparators within the MAX8213/MAX8214 are not used, tie the unused inputs to either the positive supply or ground. This prevents noise generation due to the comparator outputs switching from one logic state to another when noise is present at the inputs. When either

comparator 3 or 4 is not used, tie one input of the comparator to the positive rail and the other to ground. Tying both inputs of the same comparator to the same potential may still allow input noise to cause unwanted output switching.

Typical Applications Undervoltage Detectors

Both the MAX8213 and MAX8214 can be configured to detect when a monitored voltage has dropped below a particular level. In many applications, the MAX8214 is easier to use than the MAX8213 because it requires no external components at its outputs (Figure 4). However, the open-drain outputs of the MAX8213 make it more amenable to certain situations, such as when turning on LEDs during an undervoltage condition (see Figure 5). A low at a comparator output indicates an undervoltage condition and causes the associated LED to light. An alternative way to connect the LEDs is shown in Figure 6: this inverts the operation of the LEDs, making the circuit an overvoltage detector. Since LEDs often require several milliamps, it may be necessary to follow some of the suggestions listed in the *Application Hints* section to avoid oscillation problems. Figure 7 shows the MAX8213 outputs wired together so that a low output signal occurs when any of the four monitored voltages goes below a preset value.

Five Universal Voltage Monitors – Complete Microprocessor Voltage Monitoring

MAX8213/MAX8214

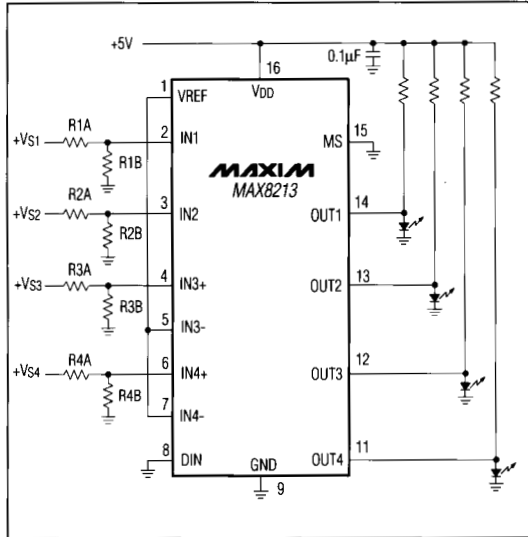

Figure 6. Overvoltage Detection by Using Alternative LED Connection

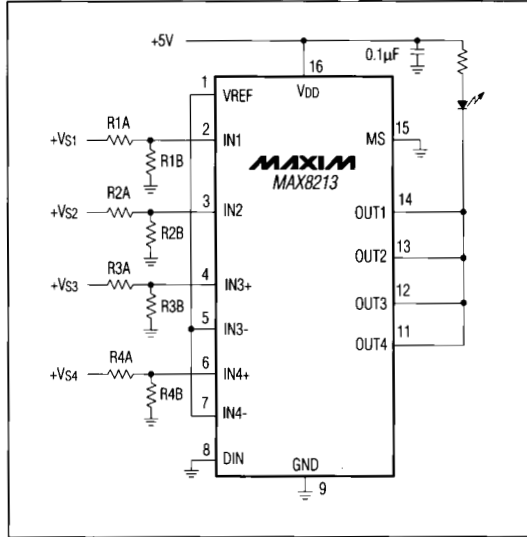

Figure 7. Single LED Indicating Undervoltage Condition on Any of Four Channels

Figure 8 illustrates the operation of these three undervoltage detection circuits. The direction of the input voltage determines at which of two trip points the comparator switches. Thus the diagram includes arrows that indicate whether the input voltage is rising or falling. The formulas allow the determination of trip-point voltages for specified resistors, and facilitate the calculation of the appropriate resistor ratios for particular trip points.

The MAX8213/MAX8214 comparator outputs correctly display a low level down to a 0.8V typical supply voltage. This is useful in undervoltage applications where the monitored power supply is also the supply connected to the VDD pin. See the section *Monitoring the Voltage Powering the MAX8213/MAX8214*.

Overvoltage Detectors

Figure 9's circuit allows the detection of overvoltage conditions. Thus, when a particular input voltage rises above a preset trip level, the corresponding comparator output goes low. The means of driving LEDs for undervoltage detectors, shown in Figures 6 and 7, also apply to overvoltage detectors constructed using MAX8213s. The waveforms and formulas of Figure 10 apply to MAX8213 as well as MAX8214 circuits.

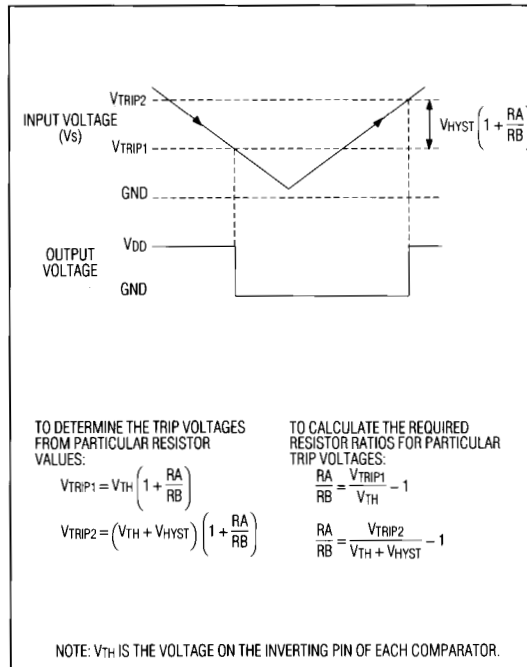

Figure 8. Undervoltage Detector Waveforms and Formulas

Five Universal Voltage Monitors - Complete Microprocessor Voltage Monitoring

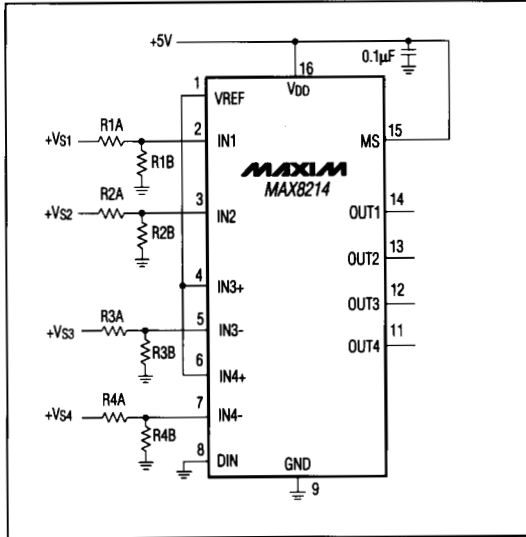

Figure 9. Quad Overvoltage Circuit

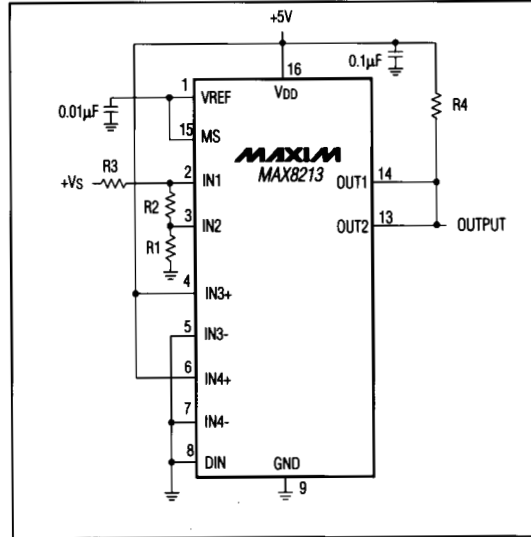

Figure 11. Window Detector

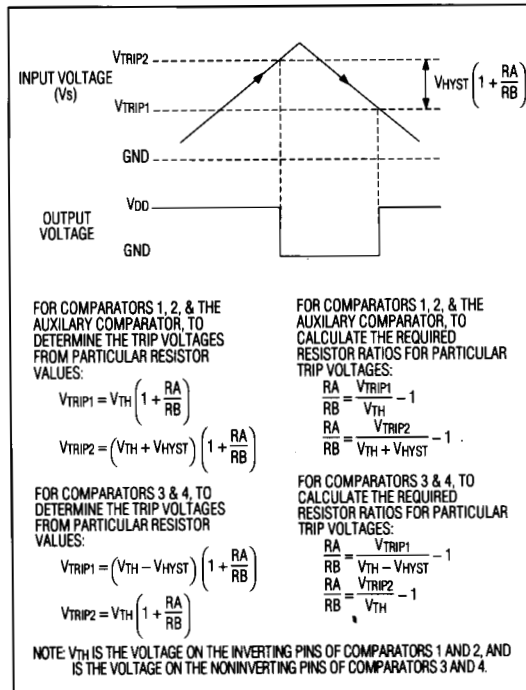

Figure 10. Overvoltage Detector Waveforms and Formulas

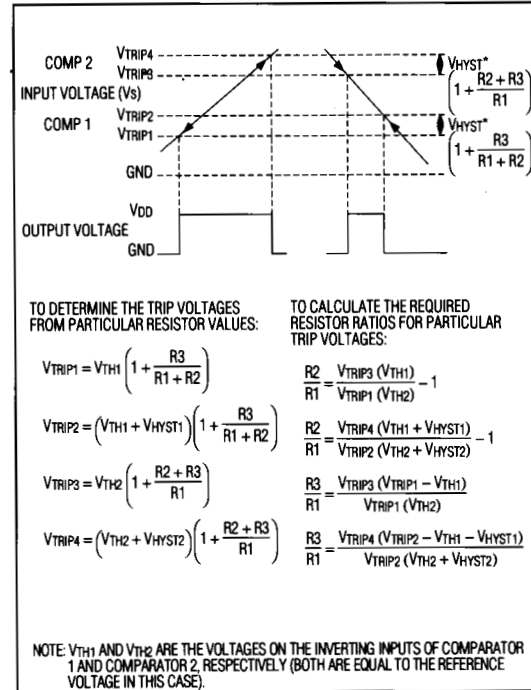

Figure 12. Window Detector Waveforms and Formulas

Five Universal Voltage Monitors - Complete Microprocessor Voltage Monitoring

MAX8213/MAX8214

Window Detectors

The circuit pictured in Figure 11 illustrates how two comparators can be configured to detect when a voltage level is between two trip voltages. The combination of comparator 1, which is configured as an undervoltage detector, and comparator 2, which is set up as an over-voltage detector, creates the voltage window. Note that the input voltage curve of Figure 12 is different than those shown for the undervoltage and overvoltage circuits. This curve shows input voltage transitions from inside to outside the window (left part of curve) and from outside to inside the window (right part of curve); the curve below shows the output waveform for these two situations. For values of R4 below about 10k, output oscillation may occur unless VREF is bypassed with 0.01μF.

Monitoring Negative Voltages

Undervoltage, overvoltage, and window-detector circuits can be made to monitor negative voltages, as shown in Figures 13, 15, and 17. This technique balances the pull-up effect of the reference with the pull-down effect of the negative voltage being monitored. It is possible that the comparator inputs will go more than 0.3V below ground when using these circuits. Despite the fact that this violates one of the device absolute maximum ratings, it is not a problem if the current that flows through the input resistor is limited to 1mA. When the comparator inputs are taken below ground, the input clamps at approximately -0.3V; thus, when the quantity $| -V_S + 0.3 |$ is divided by the input resistor, the quotient should be less than 1mA.

When building these circuits, remember that the reference output current capability is limited (see the *Electrical Characteristics*). Figure 13 shows a dual negative undervoltage detector, Figure 15 a dual negative overvoltage detector, and Figure 17 a negative voltage window detector.

Microprocessor Reset Circuit with Time Delay

It is often necessary to reset a microprocessor when its supply voltage drops below a certain level. The circuit pictured in Figure 19 generates a low output when the monitored voltage drops below the threshold set by R1 and R2. Additionally, this output remains low for 200ms after the supply voltage goes above the threshold. Microprocessor reset circuits typically include this feature because it gives the microprocessor time to be fully reset after power has been restored, and allows any capacitors in associated circuitry time to charge. The waveforms and formulas for this circuit are shown in Figure 20. Although the function for the time delay appears negative, the calculated time delay will be positive since the natural log will have a negative value.

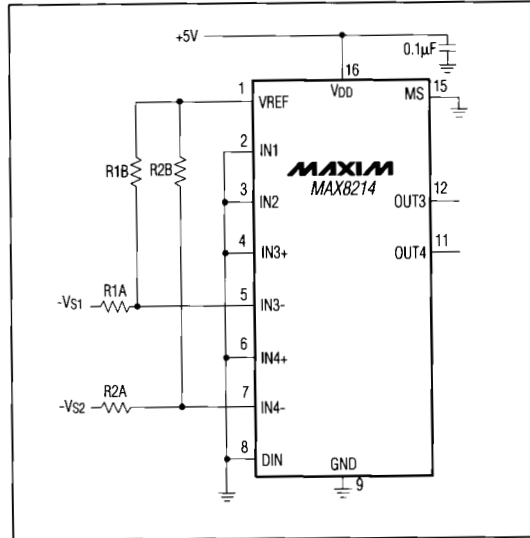

Figure 13. Dual Negative Undervoltage Detector

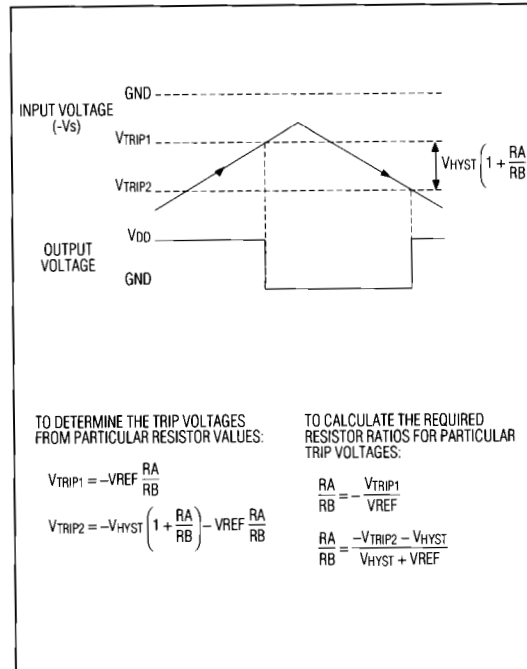

Figure 14. Dual Negative Undervoltage Detector Waveforms and Formulas

Five Universal Voltage Monitors – Complete Microprocessor Voltage Monitoring

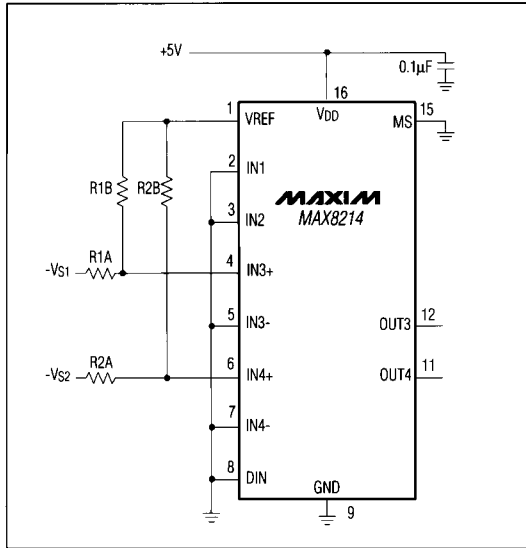

Figure 15. Dual Negative Overvoltage Detector

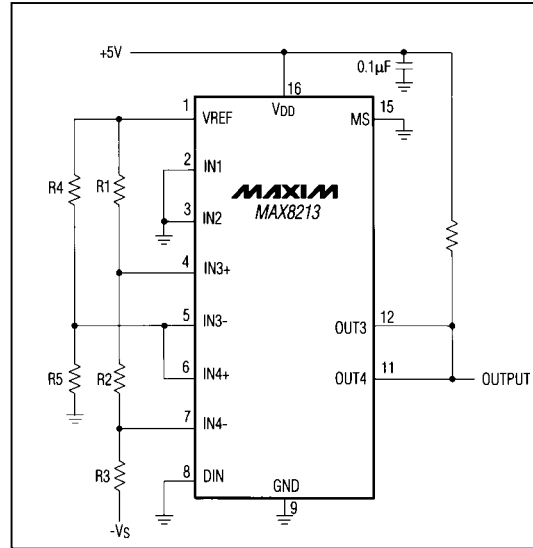

Figure 17. Negative Voltage Window Detector

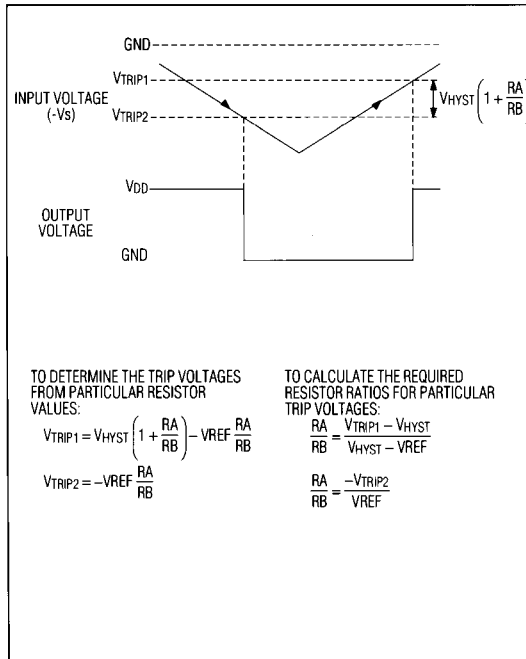

Figure 16. Dual Negative Overvoltage Detector Waveforms and Formulas

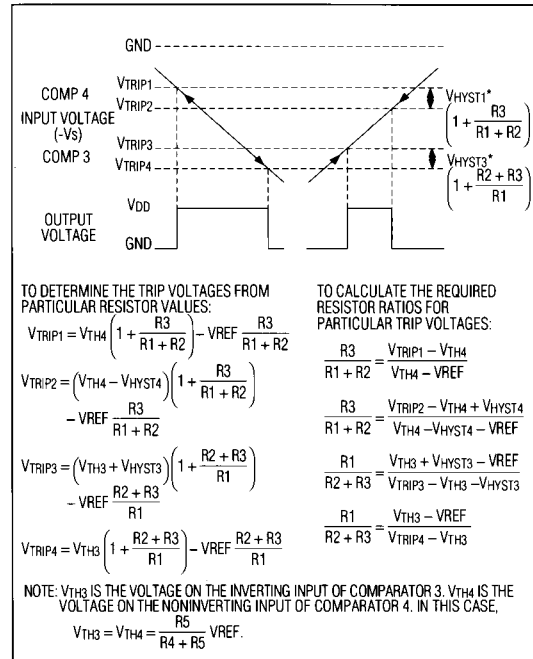

Figure 18. Negative Voltage Window Detector Waveforms and Formulas

Five Universal Voltage Monitors – Complete Microprocessor Voltage Monitoring

MAX8213/MAX8214

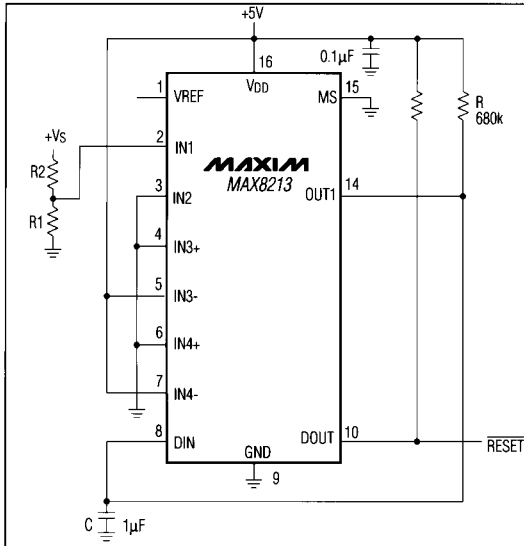

Figure 19. Microprocessor Reset Circuit with 200ms Time Delay

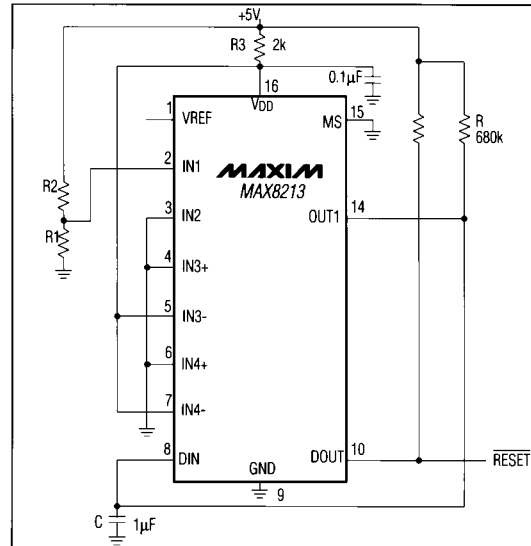

Figure 21. Microprocessor Reset Circuit Monitoring Its Own Supply Voltage

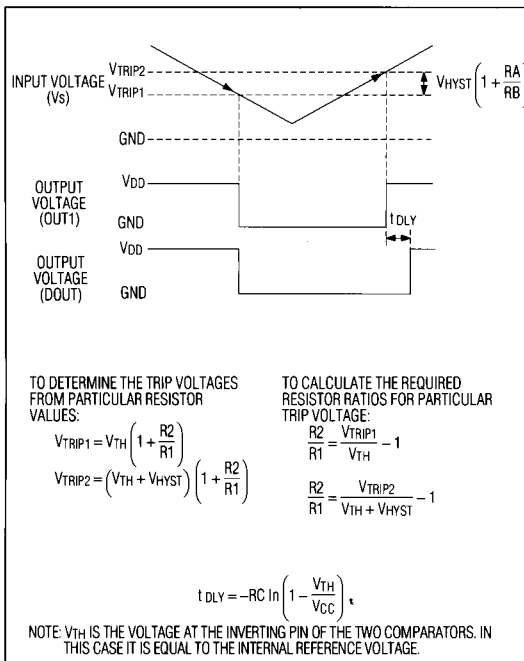

Figure 20. Microprocessor Reset with Time Delay Waveforms and Formulas

Monitoring the Voltage Powering the MAX8213/MAX8214

It is often desirable to monitor the voltage that is powering the MAX8213 and MAX8214. In general, when operated this way, these circuits are more prone to output oscillation. Of the application hints suggesting how to eliminate oscillation problems, most important in this case is the addition of the series supply resistor (see the *Application Hints* section). In general, reducing input resistor values and output current levels minimizes the possibility of oscillations. Sometimes a reference bypass capacitor may also be needed. Many of these circuits have no oscillation problems and do not require a series supply resistor (R3) or reference bypass capacitor.

Pictured in Figure 21 is the microprocessor reset circuit of Figure 19, but with the supply being monitored also powering the MAX8213. The waveforms and equations of Figure 20 also apply to this circuit.

The MAX8213/MAX8214 comparator outputs correctly display a low level down to a 0.8V typical supply voltage. This is useful in undervoltage applications where the monitored power supply is also the supply connected to the VDD pin.

Five Universal Voltage Monitors – Complete Microprocessor Voltage Monitoring

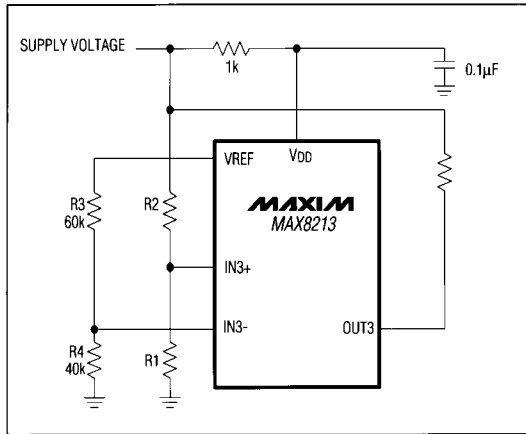

Figure 22. Undervoltage Monitoring with Supplies as Low as 2.25V for Full Military Temperature Range. R3, R4 divide the reference to create 0.5V at IN3-. R1, R2 are used to set the trip level. This current will trip when supply voltage reduces to $0.5V \left(1 + \frac{R2}{R3}\right)$

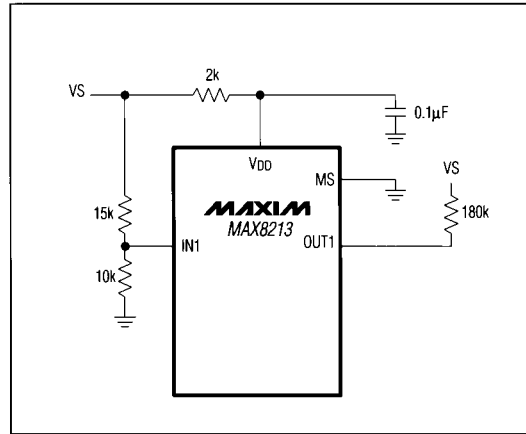

Figure 23. Undervoltage Monitoring for 3.3V Supplies. Circuit trips at 3.125V. After OUT1 goes low, the "0" level is maintained typically down to 0.8V. See Typical Operating Characteristics section.

Auxiliary Comparator

The auxiliary comparator is noninverting and can be used in microprocessor reset circuits such as those shown in Figures 19 and 21. Alternatively it can be used to monitor positive voltage levels, but it is less accurate than the other four comparators.

Lower Supply Voltage Operation

The lower supply voltage limit is controlled by the minimum voltage required for the internal reference voltage generator and by the common-mode range of the comparators. Cold temperature in both cases sets the lower limit.

The reference voltage is usable to 2.1V for commercial temperature, and to 2.25V for extended and military temperature range devices. The common-mode range required for the comparators is $2V_{BE}$ from the supply voltage. $2V_{BE}$ is roughly 1.55V at -55°C . Comparators 1, 2, and DIN require at least 2.85V for military temperature range operation, since one input of the comparator is tied to the reference voltage. However, comparators 3 and 4 have uncommitted inputs and by comparing input voltages to a fraction of the reference voltage (for example 40%, as shown in Figure 22), operation down to 2.25V is possible for the military temperature range and 2.1V for the commercial temperature range.

Ordering Information (continued)

PART	TEMP. RANGE	PIN-PACKAGE
MAX8213ACSE	0°C to $+70^{\circ}\text{C}$	16 Narrow SO
MAX8213BCSE	0°C to $+70^{\circ}\text{C}$	16 Narrow SO
MAX8213BC/D	0°C to $+70^{\circ}\text{C}$	Dice *
MAX8213AEPE	-40°C to $+85^{\circ}\text{C}$	16 Plastic DIP
MAX8213BEPE	-40°C to $+85^{\circ}\text{C}$	16 Plastic DIP
MAX8213AESE	-40°C to $+85^{\circ}\text{C}$	16 Narrow SO
MAX8213BESE	-40°C to $+85^{\circ}\text{C}$	16 Narrow SO
MAX8213AMJE	-55°C to $+125^{\circ}\text{C}$	16 CERDIP
MAX8213BMJE	-55°C to $+125^{\circ}\text{C}$	16 CERDIP
MAX8214ACPE	0°C to $+70^{\circ}\text{C}$	16 Plastic DIP
MAX8214BCPE	0°C to $+70^{\circ}\text{C}$	16 Plastic DIP
MAX8214ACSE	0°C to $+70^{\circ}\text{C}$	16 Narrow SO
MAX8214BCSE	0°C to $+70^{\circ}\text{C}$	16 Narrow SO
MAX8214BC/D	0°C to $+70^{\circ}\text{C}$	Dice *
MAX8214AEPE	-40°C to $+85^{\circ}\text{C}$	16 Plastic DIP
MAX8214BEPE	-40°C to $+85^{\circ}\text{C}$	16 Plastic DIP
MAX8214AESE	-40°C to $+85^{\circ}\text{C}$	16 Narrow SO
MAX8214BESE	-40°C to $+85^{\circ}\text{C}$	16 Narrow SO
MAX8214AMJE	-55°C to $+125^{\circ}\text{C}$	16 CERDIP
MAX8214BMJE	-55°C to $+125^{\circ}\text{C}$	16 CERDIP

* Dice are specified at $T_A = +25^{\circ}\text{C}$.

Five Universal Voltage Monitors – Complete Microprocessor Voltage Monitoring

Chip Topography

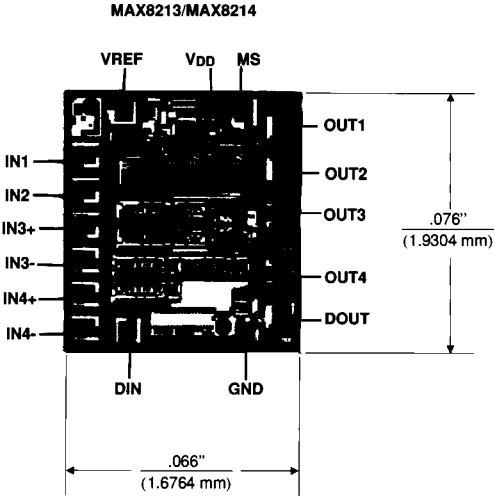

MAX8213/MAX8214 TRANSISTOR COUNT: 352;
SUBSTRATE CONNECTED TO V_{DD}.

MAX8213/MAX8214

Five Universal Voltage Monitors – Complete Microprocessor Voltage Monitoring

Package Information (continued)

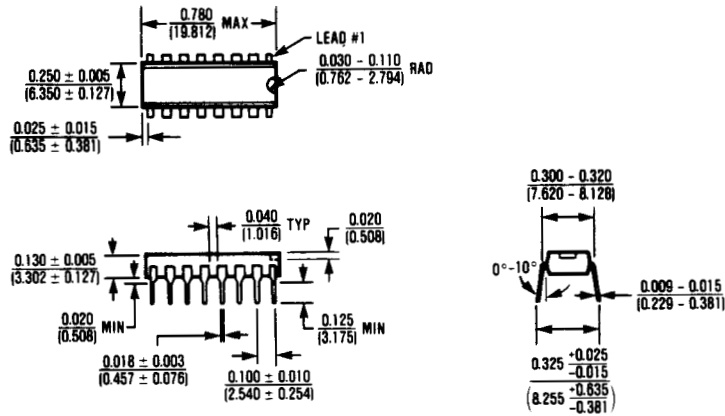

16 Lead Plastic DIP

$\theta_{JA} = 135^{\circ}\text{C/W}$
 $\theta_{JC} = 65^{\circ}\text{C/W}$

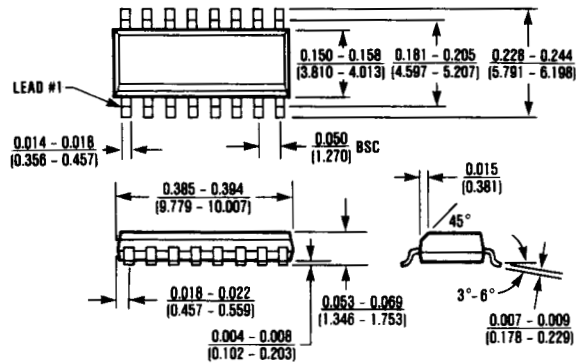

16 Lead Small Outline

$\theta_{JA} = 110^{\circ}\text{C/W}$
 $\theta_{JC} = 60^{\circ}\text{C/W}$

Maxim cannot assume responsibility for use of any circuitry other than circuitry entirely embodied in a Maxim product. No circuit patent licenses are implied. Maxim reserves the right to change the circuitry and specifications without notice at any time.

16 Maxim Integrated Products, 120 San Gabriel Drive, Sunnyvale, CA 94086 (408) 737-7600

© 1992 Maxim Integrated Products

Printed USA

MAXIM is a registered trademark of Maxim Integrated Products.

Looking for pricing, stock, or lifecycle information?

Click below to explore more details on WIN SOURCE:

- ⊖ [View MAX8214ACPE+ on WIN SOURCE](#)
- ⊖ [Maxim Integrated Information](#)

Optimize Your Supply Chain with WIN SOURCE Solutions

- ✓ Global Sourcing Solution
- ✓ Obsolete Management
- ✓ Cost Control Management
- ✓ Shortage Management
- ✓ Alternative Solution
- ✓ Excess Inventory Management