



**THE DATASHEET OF
MAX6120EUR-T**





Low-Cost, Micropower, Precision, 3-Terminal, 1.2V Voltage Reference

General Description

The MAX6120 is the lowest-power 1.2V, precision, three-terminal voltage reference offered in a SOT23 package. Ideal for 3V battery-powered equipment where power conservation is critical, the MAX6120 is a low-power alternative to existing two-terminal shunt references. Unlike two-terminal references that throw away battery current and require an external series resistor, the MAX6120 has a 70 μ A maximum supply current (typically only 50 μ A) that is independent of the input voltage. This feature translates to maximum efficiency at all battery voltages.

The MAX6120 operates from a supply voltage as low as 2.4V, and initial accuracy is $\pm 1\%$ for the SOT23 package. Output voltage temperature coefficient is typically only 30ppm/ $^{\circ}$ C, and is guaranteed to be less than 100ppm/ $^{\circ}$ C in the SOT23 package. For a guaranteed output voltage temperature coefficient of less than 50ppm/ $^{\circ}$ C, see the MAX6520 data sheet.

Applications

Battery-Powered Systems
 Portable and Hand-Held Equipment
 Data-Acquisition Systems
 Instrumentation and Process Control

Typical Operating Circuit

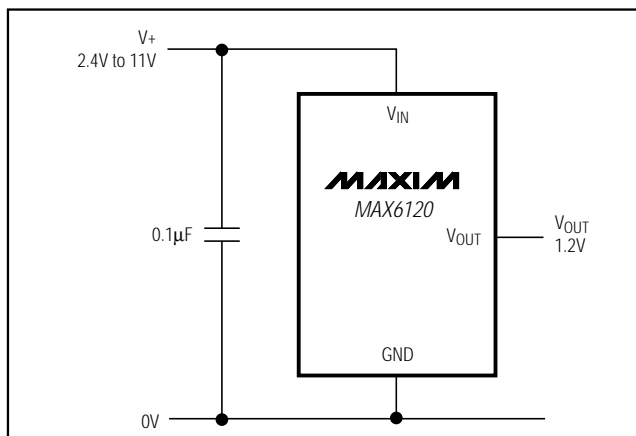

Features

- ◆ 3-Pin SOT23 Package
- ◆ Supply Current Independent of Input Voltage Over Temperature
- ◆ 50 μ A Supply Current
- ◆ 2.4V to 11V Input Voltage Range
- ◆ 30ppm/ $^{\circ}$ C Typical Tempco (SOT23)
- ◆ $\pm 1\%$ Initial Accuracy (SOT23)

Ordering Information

| PART | TEMP. RANGE | PIN-PACKAGE |
|------------|--------------------------------------|-------------|
| MAX6120ESA | -40 $^{\circ}$ C to +85 $^{\circ}$ C | 8 SO |
| MAX6120EUR | -40 $^{\circ}$ C to +85 $^{\circ}$ C | 3 SOT23-3 |

MAX6120

Pin Configurations

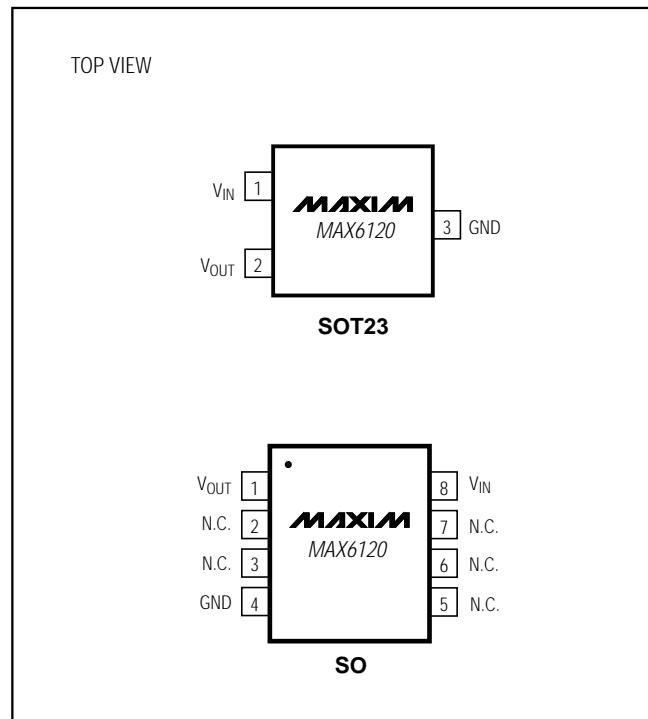

Low-Cost, Micropower, Precision, 3-Terminal, 1.2V Voltage Reference

ABSOLUTE MAXIMUM RATINGS

Supply Voltage (V_{IN})-0.3V to +12V
 V_{OUT} -0.3V to ($V_{IN} + 0.3V$)
 Output Short-Circuit DurationContinuous to Either Supply
 Continuous Power Dissipation ($T_A = +70^\circ\text{C}$)
 SOT23 (derate 4mW/ $^\circ\text{C}$ above $+70^\circ\text{C}$)320mW

Operating Temperature Range-40 $^\circ\text{C}$ to +85 $^\circ\text{C}$
 Storage Temperature Range-65 $^\circ\text{C}$ to +160 $^\circ\text{C}$
 Lead Temperature (soldering, 10sec)+300 $^\circ\text{C}$

Stresses beyond those listed under "Absolute Maximum Ratings" may cause permanent damage to the device. These are stress ratings only, and functional operation of the device at these or any other conditions beyond those indicated in the operational sections of the specifications is not implied. Exposure to absolute maximum rating conditions for extended periods may affect device reliability.

DC ELECTRICAL CHARACTERISTICS

($V_{IN} = 2.4V$, $I_{LOAD} = 0\text{mA}$, $T_A = +25^\circ\text{C}$, unless otherwise noted.)

| PARAMETER | SYMBOL | CONDITIONS | MIN | TYP | MAX | UNITS |
|--|-------------------|---|-------|-------|-------|---------------------------|
| Output Voltage | V_{OUT} | MAX6120EUR (SOT23) | | | | |
| | | $T_A = +25^\circ\text{C}$ | 1.188 | 1.200 | 1.212 | V |
| | | $T_A = T_{MIN}$ to T_{MAX} (Note 2) | 1.176 | | 1.224 | V |
| Output Voltage Temperature Coefficient | TCV_{OUT} | MAX6120EUR (SOT23), $T_A = T_{MIN}$ to T_{MAX} (Note 2) | | 30 | 100 | ppm/ $^\circ\text{C}$ |
| Output Voltage Noise | e_n | 0.1Hz to 10Hz | | 10 | | $\mu\text{Vp-p}$ |
| | | 10Hz to 10kHz | | 400 | | |
| Line Regulation | V_{OUT}/V_{IN} | $V_{IN} = 2.4V$ to 11V, $T_A = T_{MIN}$ to T_{MAX} (Note 1) | | 2 | 30 | $\mu\text{V/V}$ |
| Load Regulation | V_{OUT}/I_{OUT} | $I_{LOAD} = -50\mu\text{A}$ to 400 μA (Note 1) | | 0.1 | 1 | $\mu\text{V}/\mu\text{A}$ |
| Quiescent Supply Current | I_Q | $T_A = +25^\circ\text{C}$ | | 50 | 58 | μA |
| | | $T_A = T_{MIN}$ to T_{MAX} (Note 1) | | | 70 | |
| Change in Supply Current vs. Input Voltage | I_Q/V_{IN} | $V_{IN} = 2.4V$ to 11V | | 1.5 | 5 | $\mu\text{A/V}$ |
| Short-Circuit Output Current | I_{SC} | V_{OUT} shorted to GND | | 4.3 | | mA |
| | | V_{OUT} shorted to V_{IN} | | 400 | | μA |

Note 1: Production testing done at $T_A = +25^\circ\text{C}$, over temperature limits guaranteed by parametric correlation data.

Note 2: Contact factory for availability of a higher-grade, lower-TC option in a SOT23 package.

Typical Operating Characteristics

($V_{IN} = 3V$, $I_{LOAD} = 0\text{mA}$, $T_A = +25^\circ\text{C}$, unless otherwise noted.)

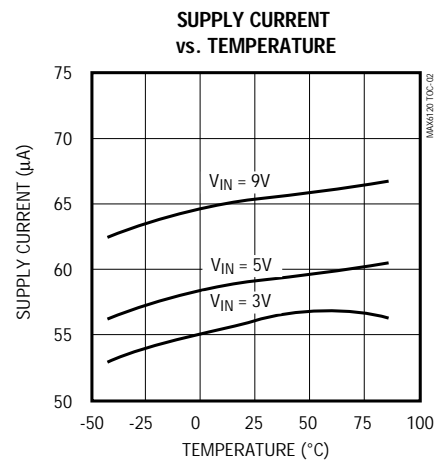
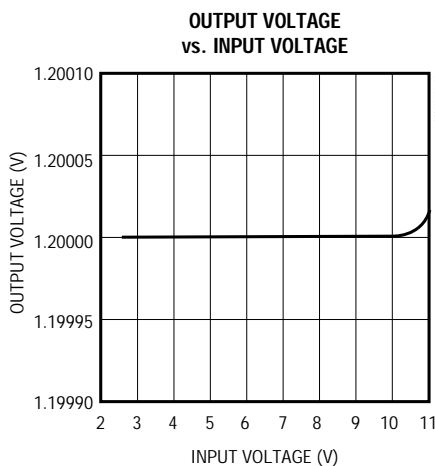
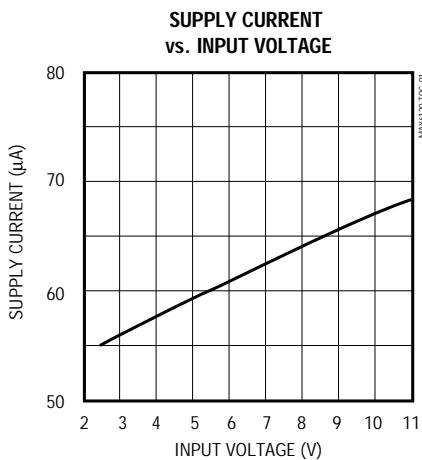

Low-Cost, Micropower, Precision, 3-Terminal, 1.2V Voltage Reference

MAX6120

Typical Operating Characteristics (continued)

($V_{IN} = 3V$, $I_{LOAD} = 0mA$, $T_A = +25^{\circ}C$, unless otherwise noted.)

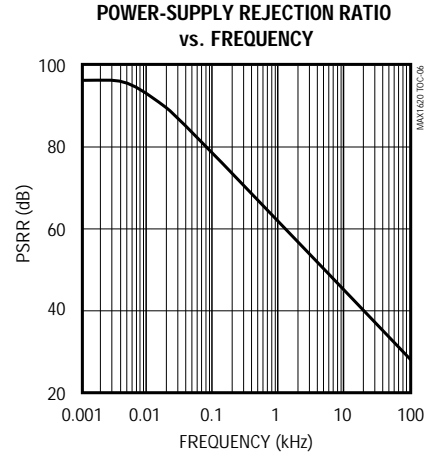
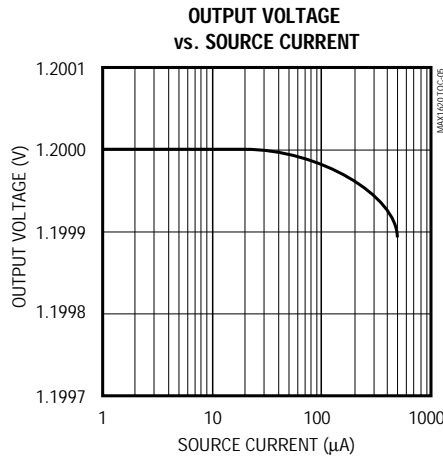
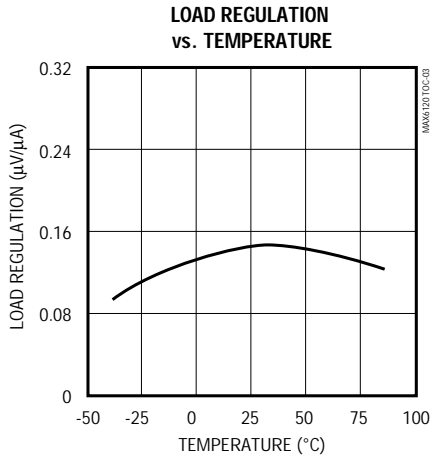

0.1Hz TO 100Hz NOISE

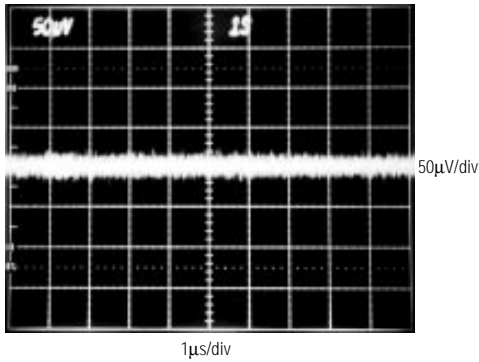

LOAD-TRANSIENT RESPONSE

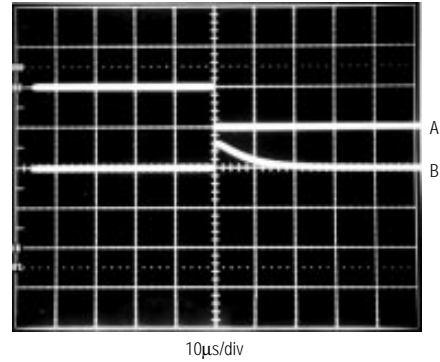

LOAD-TRANSIENT RESPONSE

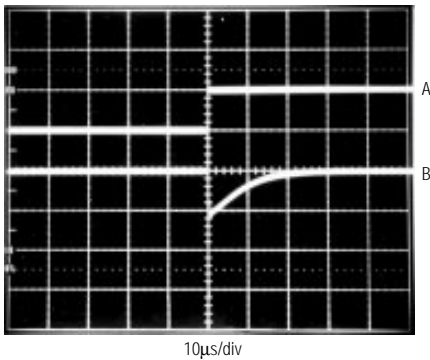

LINE-TRANSIENT RESPONSE

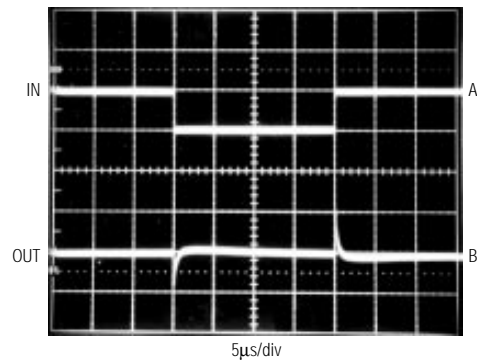

Low-Cost, Micropower, Precision, 3-Terminal, 1.2V Voltage Reference

Pin Description

| PIN | | NAME | FUNCTION |
|-------|---------------|------------------|-------------------------------------|
| SOT23 | SO | | |
| 1 | 8 | V _{IN} | Input Voltage |
| 2 | 1 | V _{OUT} | Reference Output |
| 3 | 4 | GND | Ground |
| — | 2, 3, 5, 6, 7 | N.C. | No Connect—not internally connected |

Applications Information

Input Bypassing

For the best line-transient performance, decouple the input with a 0.1µF ceramic capacitor as shown in the *Typical Operating Circuit*. Locate the capacitor as close to the device pin as possible. Where transient performance is less important, no capacitor is necessary.

Output Bypass

The MAX6120 performs well without an output decoupling capacitor. If your application requires an output charge reservoir (e.g., to decouple the reference from the input of a DAC), then make sure that the total output capacitive load does not exceed 10nF.

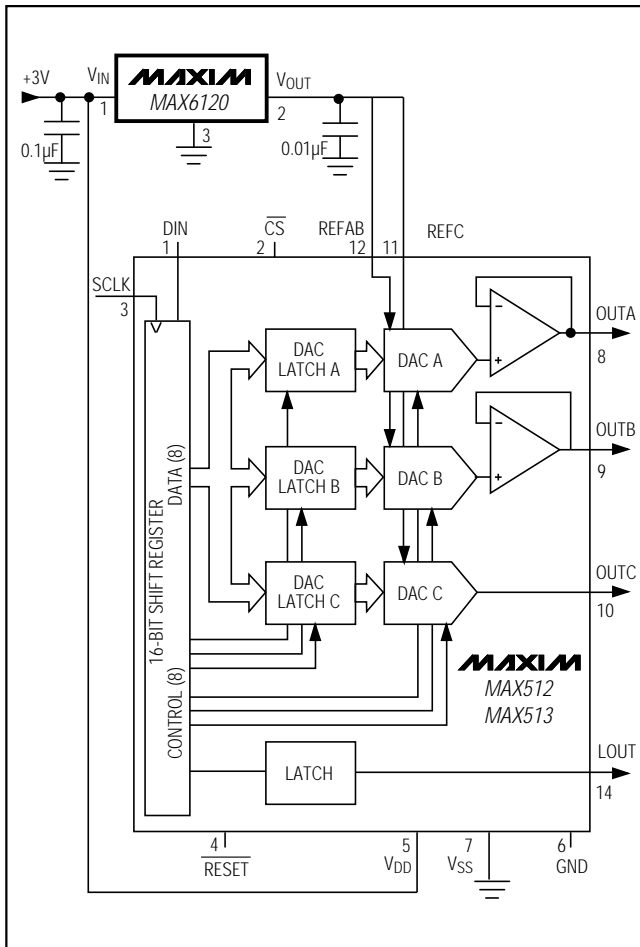

Figure 1. 3V, Triple, 8-Bit Serial DAC

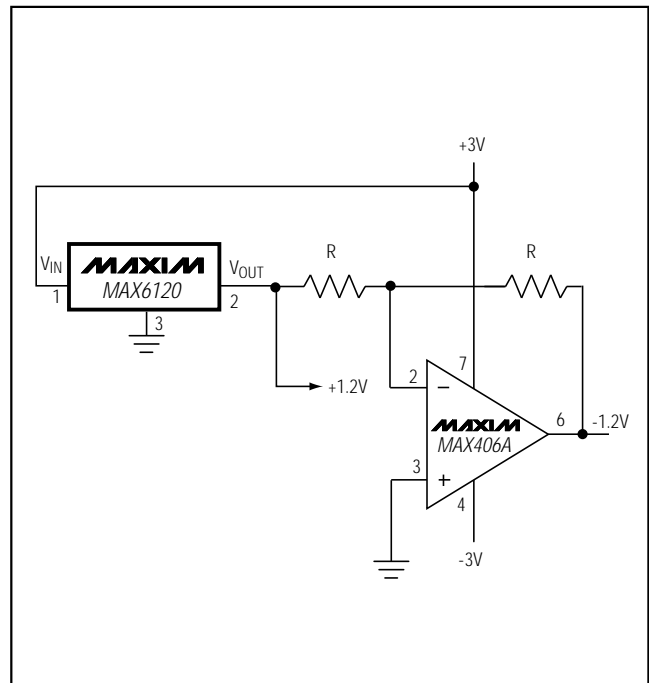

Figure 2. Low-Power ±1.2V Reference

Chip Information

TRANSISTOR COUNT: 39

Low-Cost, Micropower, Precision, 3-Terminal, 1.2V Voltage Reference

Tape-and-Reel Information

MAX6120

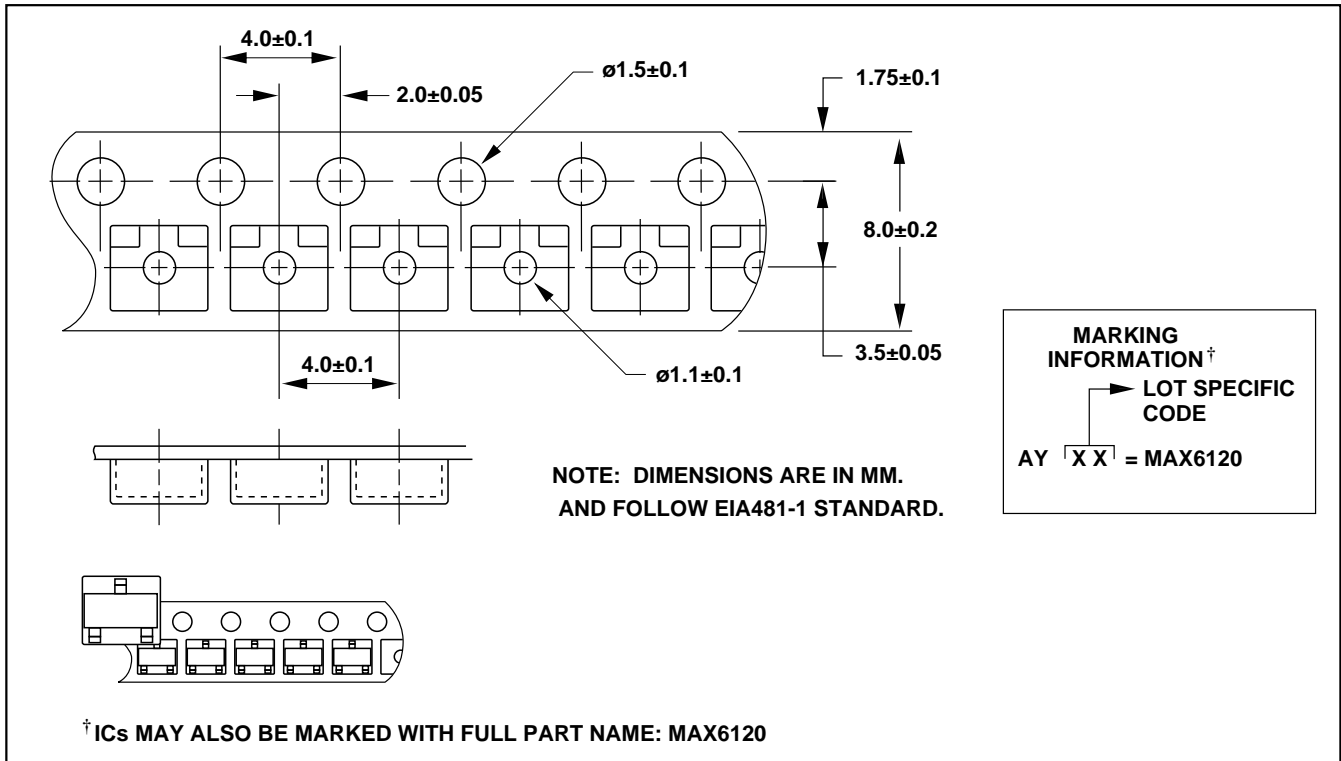

Low-Cost, Micropower, Precision, 3-Terminal, 1.2V Voltage Reference

Package Information

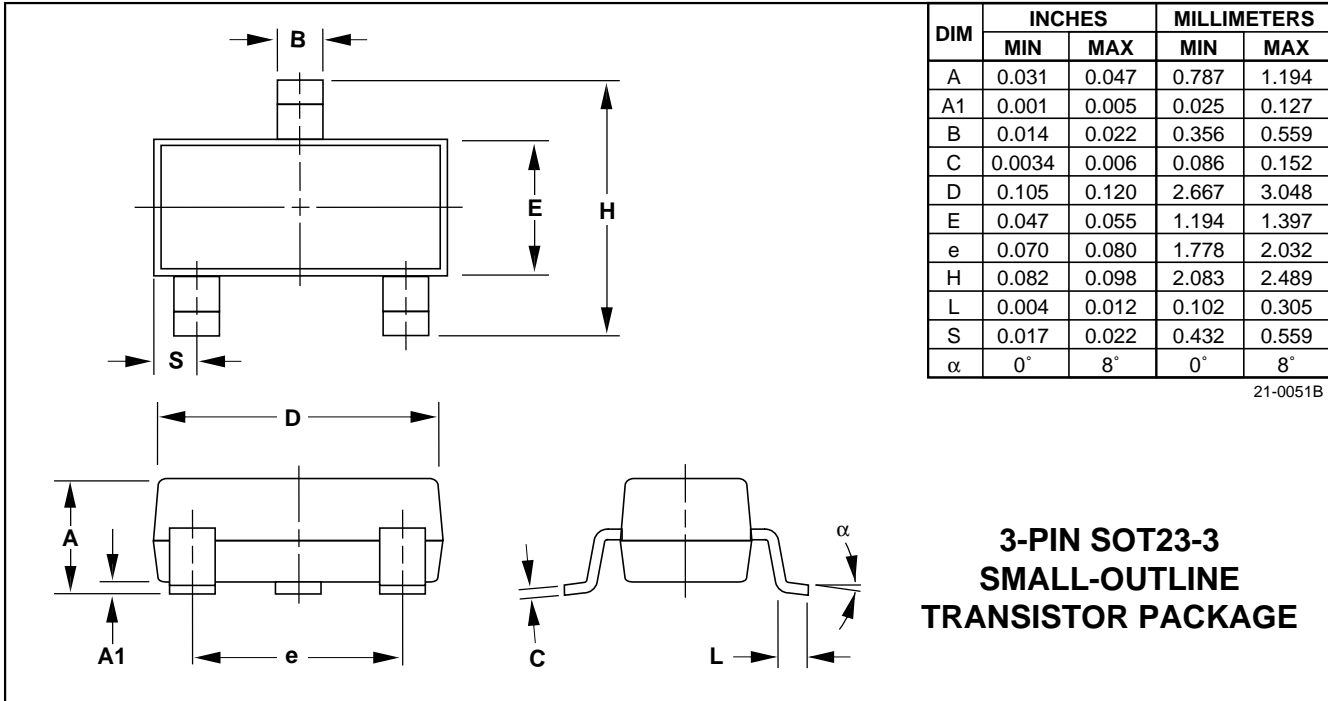

Maxim cannot assume responsibility for use of any circuitry other than circuitry entirely embodied in a Maxim product. No circuit patent licenses are implied. Maxim reserves the right to change the circuitry and specifications without notice at any time.

6 Maxim Integrated Products, 120 San Gabriel Drive, Sunnyvale, CA 94086 (408) 737-7600

Looking for pricing, stock, or lifecycle information?

Click below to explore more details on WIN SOURCE:

 [View MAX6120EUR-T on WIN SOURCE](#)

 [Maxim Integrated](#) Information

Optimize Your Supply Chain with WIN SOURCE Solutions

-  Global Sourcing Solution
-  Obsolete Management
-  Cost Control Management
-  Shortage Management
-  Alternative Solution
-  Excess Inventory Management