



**THE DATASHEET OF  
MAX5582EUP+**





# Buffered, Fast-Settling, Quad, 12-/10-/8-Bit, Voltage-Output DACs

## General Description

The MAX5580–MAX5585 quad, 12-/10-/8-bit, voltage-output, digital-to-analog converters (DACs) offer buffered outputs and a 3 $\mu$ s maximum settling time at the 12-bit level. The DACs operate from a +2.7V to +5.25V analog supply and a separate +1.8V to +5.25V digital supply. The 20MHz, 3-wire, serial interface is compatible with SPI™, QSPI™, MICROWIRE™, and digital signal processor (DSP) protocol applications. Multiple devices can share a common serial interface in direct-access or daisy-chained configuration. The MAX5580–MAX5585 provide two multifunctional, user-programmable, digital I/O ports. The externally selectable power-up states of the DAC outputs are either zero scale, mid-scale, or full scale. Software-selectable FAST and SLOW settling modes decrease settling time in FAST mode, or reduce supply current in SLOW mode.

The MAX5580/MAX5581 are 12-bit DACs, the MAX5582/MAX5583 are 10-bit DACs, and the MAX5584/MAX5585 are 8-bit DACs. The MAX5580/MAX5582/MAX5584 provide unity-gain-configured output buffers, while the MAX5581/MAX5583/MAX5585 provide force-sense-configured output buffers. The MAX5580–MAX5585 operate over the extended -40°C to +85°C temperature range and are available in a space-saving, 6.5mm x 4.4mm, 20-pin, TSSOP package.

SPI/QSPI are trademarks of Motorola, Inc.

MICROWIRE is a trademark of National Semiconductor Corp.

## Features

- ◆ 3 $\mu$ s (max) 12-Bit Settling Time to 0.5 LSB
- ◆ Quad, 12-/10-/8-Bit Serial DACs in TSSOP Package
- ◆  $\pm 1$  LSB (max) INL and DNL at 12-Bit Resolution
- ◆ Two User-Programmable Digital I/O Ports
- ◆ Single +2.7V to +5.25V Analog Supply
- ◆ +1.8V to AV<sub>DD</sub> Digital Supply
- ◆ 20MHz, 3-Wire, SPI-/QSPI-/MICROWIRE-/DSP-Compatible Serial Interface
- ◆ Glitch-Free Outputs Power Up to Zero Scale, Midscale, or Full Scale Controlled by PU Pin
- ◆ Unity-Gain or Force-Sense-Configured Output Buffers

## Applications

Portable Instrumentation  
Automatic Test Equipment (ATE)  
Digital Offset and Gain Adjustment  
Automatic Tuning  
Programmable Voltage and Current Sources  
Programmable Attenuators  
Industrial Process Controls  
Motion Control  
Microprocessor ( $\mu$ P)-Controlled Systems  
Power Amplifier Control  
Fast Parallel-DAC to Serial-DAC Upgrades

Pin Configuration appears at end of data sheet.

## Ordering Information/Selector Guide

| PART         | RESOLUTION (BITS) | INL (LSB max) | OUTPUT BUFFER CONFIGURATION | PIN-PACKAGE  |
|--------------|-------------------|---------------|-----------------------------|--------------|
| MAX5580AEUP+ | 12                | $\pm 1$       | Unity gain                  | 20 TSSOP-EP* |
| MAX5580BEUP+ | 12                | $\pm 4$       | Unity gain                  | 20 TSSOP-EP* |
| MAX5581AEUP+ | 12                | $\pm 1$       | Force sense                 | 20 TSSOP-EP* |
| MAX5581BEUP+ | 12                | $\pm 4$       | Force sense                 | 20 TSSOP-EP* |
| MAX5582EUP+  | 10                | $\pm 1$       | Unity gain                  | 20 TSSOP-EP* |
| MAX5583EUP+  | 10                | $\pm 1$       | Force sense                 | 20 TSSOP-EP* |
| MAX5584EUP+  | 8                 | $\pm 0.5$     | Unity gain                  | 20 TSSOP-EP* |
| MAX5585EUP+  | 8                 | $\pm 0.5$     | Force sense                 | 20 TSSOP-EP* |

+Denotes a lead-free/RoHS-compliant package.

\*EP = Exposed paddle.

Note: All devices are specified over the -40°C to +85°C operating temperature range.



Maxim Integrated Products 1

For pricing delivery, and ordering information please contact Maxim Direct at 1-888-629-4642, or visit Maxim's website at [www.maxim-ic.com](http://www.maxim-ic.com).

MAX5580–MAX5585

# Buffered, Fast-Settling, Quad, 12-/10-/8-Bit, Voltage-Output DACs

## ABSOLUTE MAXIMUM RATINGS

|   |  |
|---|--|
| AVDD to DVDD  | ±6V  |
| AGND to DGND  | ±0.3V                                      |
| AVDD to AGND, DGND                                  | -0.3V to +6V                               |
| DVDD to AGND, DGND                                  | -0.3V to +6V                               |
| FB <sub>-</sub> , OUT <sub>-</sub> ,<br>REF to AGND | -0.3V to the lower of (AVDD + 0.3V) or +6V |
| SCLK, DIN, CS, PU,<br>DSP to DGND                   | -0.3V to the lower of (DVDD + 0.3V) or +6V |
| UPIO1, UPIO2<br>to DGND                             | -0.3V to the lower of (DVDD + 0.3V) or +6V |

|   |                 |
|---|-----------------|
| Maximum Current into Any Pin                          | ±50mA           |
| Continuous Power Dissipation (T <sub>A</sub> = +70°C) |                 |
| 20-Pin TSSOP (derate 21.7mW/°C above +70°C)           | 1739mW          |
| Operating Temperature Range                           | -40°C to +85°C  |
| Storage Temperature Range                             | -65°C to +150°C |
| Junction Temperature                                  | +150°C          |
| Lead Temperature (soldering, 10s)                     | +300°C          |

Stresses beyond those listed under "Absolute Maximum Ratings" may cause permanent damage to the device. These are stress ratings only, and functional operation of the device at these or any other conditions beyond those indicated in the operational sections of the specifications is not implied. Exposure to absolute maximum rating conditions for extended periods may affect device reliability.

## ELECTRICAL CHARACTERISTICS

(AVDD = 2.7V to 5.25V, DVDD = 1.8V to AVDD, VAGND = 0, VDGND = 0, VREF = 2.5V (for AVDD = 2.7V to 5.25V), VREF = 4.096V (for AVDD = 4.5V to 5.25V), R<sub>L</sub> = 10kΩ, C<sub>L</sub> = 100pF, T<sub>A</sub> = T<sub>MIN</sub> to T<sub>MAX</sub>, unless otherwise noted. Typical values are at T<sub>A</sub> = +25°C.) (Note 1)

| PARAMETER                 | SYMBOL | CONDITIONS  | MIN                        | TYP    | MAX          | UNITS |
|---------------------------|--------|---|----------------------------|--------|--------------|-------|
| <b>STATIC ACCURACY</b>    |        |   |                            |        |              |       |
| Resolution                | N      | MAX5580/MAX5581   | 12                         |        | Bits         |       |
|                           |        | MAX5582/MAX5583   | 10                         |        |              |       |
|                           |        | MAX5584/MAX5585   | 8                          |        |              |       |
| Integral Nonlinearity     | INL    | VREF = 2.5V at AVDD = 2.7V and VREF = 4.096V at AVDD = 5.25V (Note 2) | MAX5580A/MAX5581A (12 bit) | ±1     |              | LSB   |
|                           |        |   | MAX5580B/MAX5581B (12 bit) | ±2     | ±4           |       |
|                           |        |   | MAX5582/MAX5583 (10 bit)   | ±0.5   | ±1           |       |
|                           |        |   | MAX5584/MAX5585 (8 bit)    | ±0.125 | ±0.5         |       |
| Differential Nonlinearity | DNL    | Guaranteed monotonic (Note 2)   | ±1                         |        | LSB          |       |
| Offset Error              | VOS    | MAX5580A/MAX5581A (12 bit), decimal code = 250                        | ±5                         |        | mV           |       |
|                           |        | MAX5580B/MAX5581B (12 bit), decimal code = 40                         | ±5                         | ±25    |              |       |
|                           |        | MAX5582/MAX5583 (10 bit), decimal code = 20                           | ±5                         | ±25    |              |       |
|                           |        | MAX5584/MAX5585 (8 bit), decimal code = 5                             | ±5                         | ±25    |              |       |
| Offset-Error Drift        |        |   | 5                          |        | ppm of FS/°C |       |
| Gain Error                | GE     | Full-scale output   | MAX5580A, VREF = 4.096V    | ±1     | ±5           | LSB   |
|                           |        |   | MAX5580A, VREF = 2.5V      | ±1.5   | ±7           |       |
|                           |        |   | MAX5581A, VREF = 4.096V    | ±0.5   | ±4           |       |
|                           |        |   | MAX5581A, VREF = 2.5V      | ±1     | ±5           |       |
|                           |        |   | MAX5580B/MAX5581B (12 bit) | ±20    | ±40          |       |
|                           |        |   | MAX5582/MAX5583 (10 bit)   | ±5     | ±10          |       |
|                           |        |   | MAX5584/MAX5585 (8 bit)    | ±2     | ±3           |       |
| Gain-Error Drift          |        |   | 1                          |        | ppm of FS/°C |       |

# Buffered, Fast-Settling, Quad, 12-/10-/8-Bit, Voltage-Output DACs

MAX5580-MAX5585

## ELECTRICAL CHARACTERISTICS (continued)

( $AV_{DD} = 2.7V$  to  $5.25V$ ,  $DV_{DD} = 1.8V$  to  $AV_{DD}$ ,  $V_{AGND} = 0$ ,  $V_{DGND} = 0$ ,  $V_{REF} = 2.5V$  (for  $AV_{DD} = 2.7V$  to  $5.25V$ ),  $V_{REF} = 4.096V$  (for  $AV_{DD} = 4.5V$  to  $5.25V$ ),  $R_L = 10k\Omega$ ,  $C_L = 100pF$ ,  $T_A = T_{MIN}$  to  $T_{MAX}$ , unless otherwise noted. Typical values are at  $T_A = +25^\circ C$ .) (Note 1)

| PARAMETER  | SYMBOL    | CONDITIONS  | MIN                  | TYP       | MAX             | UNITS         |
|--|-----------|---|----------------------|-----------|-----------------|---------------|
| Power-Supply Rejection Ratio                           | PSRR      | Full-scale output, $AV_{DD} = 2.7V$ to $5.25V$          |                      | 200       |                 | $\mu V/V$     |
| <b>REFERENCE INPUT</b>                                 |           |   |                      |           |                 |               |
| Reference-Input Range                                  | $V_{REF}$ |   | 0.25                 |           | $AV_{DD}$       | V             |
| Reference-Input Resistance                             | $R_{REF}$ | Normal operation (no code dependence)                   | 145                  | 200       |                 | $k\Omega$     |
| Reference Leakage Current                              |           | Shutdown mode   |                      | 0.5       | 1               | $\mu A$       |
| <b>DAC OUTPUT CHARACTERISTICS</b>                      |           |   |                      |           |                 |               |
| Output-Voltage Noise                                   |           | SLOW mode, full scale                                   | Unity gain           | 85        |                 | $\mu V_{RMS}$ |
|  |           |   | Force sense          | 67        |                 |               |
|  |           | FAST mode, full scale                                   | Unity gain           | 140       |                 |               |
|  |           |   | Force sense          | 110       |                 |               |
| Output-Voltage Range (Note 3)                          |           | Unity-gain output                                       | 0                    |           | $AV_{DD}$       | V             |
|  |           | Force-sense output                                      | 0                    |           | $AV_{DD} / 2$   |               |
| DC Output Impedance                                    |           |   |                      | 38        |                 | $\Omega$      |
| Short-Circuit Current                                  |           | $AV_{DD} = 5V$ , $OUT_+$ to AGND, full scale, FAST mode |                      | 57        |                 | mA            |
|  |           | $AV_{DD} = 3V$ , $OUT_+$ to AGND, full scale, FAST mode |                      | 45        |                 |               |
| Power-Up Time  |           | From $DV_{DD}$ , applied until interface is functional  |                      | 30        | 60              | $\mu s$       |
| Wake-Up Time   |           | Coming out of shutdown, outputs settled                 |                      | 40        |                 | $\mu s$       |
| Output $OUT_+$ and $FB_+$ Open-Circuit Leakage Current |           | Programmed in shutdown mode, force-sense outputs only   |                      | 0.01      |                 | $\mu A$       |
| <b>DIGITAL OUTPUTS (UPIO_)</b>                         |           |   |                      |           |                 |               |
| Output High Voltage                                    | $V_{OH}$  | $I_{SOURCE} = 0.5mA$                                    |                      |           | $DV_{DD} - 0.5$ | V             |
| Output Low Voltage                                     | $V_{OL}$  | $I_{SINK} = 2mA$  |                      |           | 0.4             | V             |
| <b>DIGITAL INPUTS (SCLK, CS, DIN, DSP, UPIO_)</b>      |           |   |                      |           |                 |               |
| Input High Voltage                                     | $V_{IH}$  | $DV_{DD} \geq 2.7V$                                     | 2.4                  |           |                 | V             |
|  |           | $DV_{DD} < 2.7V$  | $0.7 \times DV_{DD}$ |           |                 |               |
| Input Low Voltage                                      | $V_{IL}$  | $DV_{DD} > 3.6V$  |                      |           | 0.8             | V             |
|  |           | $2.7V \leq DV_{DD} \leq 3.6V$                           |                      |           | 0.6             |               |
|  |           | $DV_{DD} < 2.7V$  |                      |           | 0.2             |               |
| Input Leakage Current                                  | $I_{IN}$  |   |                      | $\pm 0.1$ | $\pm 1$         | $\mu A$       |
| Input Capacitance                                      | $C_{IN}$  |   |                      | 10        |                 | pF            |

# Buffered, Fast-Settling, Quad, 12-/10-/8-Bit, Voltage-Output DACs

## ELECTRICAL CHARACTERISTICS (continued)

( $A_{V_{DD}} = 2.7V$  to  $5.25V$ ,  $DV_{DD} = 1.8V$  to  $A_{V_{DD}}$ ,  $V_{AGND} = 0$ ,  $V_{DGND} = 0$ ,  $V_{REF} = 2.5V$  (for  $A_{V_{DD}} = 2.7V$  to  $5.25V$ ),  $V_{REF} = 4.096V$  (for  $A_{V_{DD}} = 4.5V$  to  $5.25V$ ),  $R_L = 10k\Omega$ ,  $C_L = 100pF$ ,  $T_A = T_{MIN}$  to  $T_{MAX}$ , unless otherwise noted. Typical values are at  $T_A = +25^\circ C$ .) (Note 1)

| PARAMETER                                       | SYMBOL      | CONDITIONS  | MIN   | TYP           | MAX       | UNITS      |
|---|-------------|---|---|---------------|-----------|------------|
| <b>PU INPUT</b>                                 |             |   |   |               |           |            |
| Input High Voltage                              | $V_{IH-PU}$ |   | $DV_{DD} - 200mV$                                     |               |           | V          |
| Input Low Voltage                               | $V_{IL-PU}$ |   |   |               | 200       | mV         |
| Input Leakage Current                           | $I_{IN-PU}$ | PU still considered floating when connected to a tri-state bus  |   |               | $\pm 200$ | nA         |
| <b>DYNAMIC PERFORMANCE</b>                      |             |   |   |               |           |            |
| Voltage-Output Slew Rate                        | SR          | FAST mode   |   | 3.6           |           | V/ $\mu s$ |
|   |             | SLOW mode   |   | 1.6           |           |            |
| Voltage-Output Settling Time (Note 4), Figure 5 | ts          | FAST mode   | MAX5580/MAX5581 from code 322 to code 4095 to 0.5 LSB | 2             | 3         | $\mu s$    |
|   |             |   | MAX5582/MAX5583 from code 10 to code 1023 to 0.5 LSB  | 1.5           | 3         |            |
|   |             |   | MAX5584/MAX5585 from code 3 to code 255 to 0.5 LSB    | 1             | 2         |            |
|   |             | SLOW mode   | MAX5580/MAX5581 from code 322 to code 4095 to 0.5 LSB | 3             | 6         |            |
|   |             |   | MAX5582/MAX5583 from code 10 to code 1023 0.5 LSB     | 2.5           | 6         |            |
|   |             |   | MAX5584/MAX5585 from code 3 to code 255 to 0.5 LSB    | 2             | 4         |            |
| FB_ Input Voltage                               |             |   | 0   | $V_{REF} / 2$ |           | V          |
| FB_ Input Current                               |             |   |   |               | 0.1       | $\mu A$    |
| Reference -3dB Bandwidth (Note 5)               |             | Unity gain  |   | 200           |           | kHz        |
|   |             | Force sense   |   | 150           |           |            |
| Digital Feedthrough                             |             | $\overline{CS} = DV_{DD}$ , code = zero scale, any digital input from 0 to $DV_{DD}$ and $DV_{DD}$ to 0, $f = 100kHz$ |   | 0.1           |           | nV-s       |
| Digital-to-Analog Glitch Impulse                |             | Major carry transition  |   | 2             |           | nV-s       |
| DAC-to-DAC Crosstalk                            |             | (Note 6)  |   | 15            |           | nV-s       |

# Buffered, Fast-Settling, Quad, 12-/10-/8-Bit, Voltage-Output DACs

## ELECTRICAL CHARACTERISTICS (continued)

( $V_{DD} = 2.7V$  to  $5.25V$ ,  $DV_{DD} = 1.8V$  to  $V_{DD}$ ,  $V_{AGND} = 0$ ,  $V_{DGND} = 0$ ,  $V_{REF} = 2.5V$  (for  $V_{DD} = 2.7V$  to  $5.25V$ ),  $V_{REF} = 4.096V$  (for  $V_{DD} = 4.5V$  to  $5.25V$ ),  $R_L = 10k\Omega$ ,  $C_L = 100pF$ ,  $T_A = T_{MIN}$  to  $T_{MAX}$ , unless otherwise noted. Typical values are at  $T_A = +25^\circ C$ .) (Note 1)

| PARAMETER                    | SYMBOL                            | CONDITIONS   | MIN         | TYP | MAX      | UNITS   |
|------------------------------|-----------------------------------|--|-------------|-----|----------|---------|
| <b>POWER REQUIREMENTS</b>    |                                   |  |             |     |          |         |
| Analog Supply Voltage Range  | $V_{DD}$                          |  | 2.70        |     | 5.25     | V       |
| Digital Supply Voltage Range | $DV_{DD}$                         |  | 1.8         |     | $V_{DD}$ | V       |
| Operating Supply Current     | $I_{AVDD} + I_{DVDD}$             | SLOW mode, all digital inputs at DGND or DVDD, no load, $V_{REF} = 4.096V$ | Unity gain  | 0.9 | 1.6      | mA      |
|                              |                                   |  | Force sense | 1.6 | 2.4      |         |
|                              |                                   | FAST mode, all digital inputs at DGND or DVDD, no load, $V_{REF} = 4.096V$ | Unity gain  | 1.6 | 4        |         |
|                              |                                   |  | Force sense | 2.3 | 4        |         |
| Shutdown Supply Current      | $I_{AVDD(SHDN)} + I_{DVDD(SHDN)}$ | No clocks, all digital inputs at DGND or DVDD, all DACs in shutdown mode   |             | 0.5 | 1        | $\mu A$ |

**Note 1:** For the force-sense versions,  $FB_+$  is connected to its respective  $OUT_+$ , and  $V_{OUT}(\max) = V_{REF} / 2$ , unless otherwise noted.

**Note 2:** Linearity guaranteed from decimal code 250 to code 4095 for the MAX5580A/MAX5581A (12 bit, A grade), code 40 to code 4095 for the MAX5580B/MAX5581B (12 bit, B grade), code 20 to code 1023 for the MAX5582/MAX5583 (10 bit), and code 5 to code 255 for the MAX5584/MAX5585 (8 bit).

**Note 3:** Represents the functional range. The linearity is guaranteed at  $V_{REF} = 2.5V$  (for  $V_{DD}$  from 2.7V to 5.25V), and  $V_{REF} = 4.096V$  (for  $V_{DD} = 4.5V$  to 5.25V). See the *Typical Operating Characteristics* section for linearity at other voltages.

**Note 4:** Guaranteed by design.

**Note 5:** The reference -3dB bandwidth is measured with a 0.1V<sub>p-p</sub> sine wave on  $V_{REF}$  and with full-scale input code.

**Note 6:** DC crosstalk is measured as follows: outputs of DACA–DACD are set to full scale and the output of DACD is measured. While keeping DACD unchanged, the outputs of DACA–DACC are transitioned to zero scale and the  $\Delta V_{OUT}$  of DACD is measured.

MAX5580–MAX5585

# Buffered, Fast-Settling, Quad, 12-/10-/8-Bit, Voltage-Output DACs

## TIMING CHARACTERISTICS—DSP Mode Disabled (3V, 3.3V, 5V Logic) (Figure 1)

(DV<sub>DD</sub> = 2.7V to 5.25V, AGND = DGND = 0, T<sub>A</sub> = T<sub>MIN</sub> to T<sub>MAX</sub>, unless otherwise noted.)

| PARAMETER   | SYMBOL                      | CONDITIONS   | MIN | TYP | MAX | UNITS |
|---|-----------------------------|--|-----|-----|-----|-------|
| SCLK Frequency  | f <sub>SCLK</sub>           | 2.7V < DV <sub>DD</sub> < 5.25V  |     |     | 20  | MHz   |
| SCLK Pulse-Width High   | t <sub>CH</sub>             | (Note 7)   | 20  |     |     | ns    |
| SCLK Pulse-Width Low  | t <sub>CL</sub>             | (Note 7)   | 20  |     |     | ns    |
| $\overline{\text{CS}}$ Fall to SCLK Rise Setup Time   | t <sub>CSS</sub>            |  | 10  |     |     | ns    |
| SCLK Rise to $\overline{\text{CS}}$ Rise Hold Time  | t <sub>C<sub>SH</sub></sub> |  | 5   |     |     | ns    |
| SCLK Rise to $\overline{\text{CS}}$ Fall Setup Time   | t <sub>C<sub>S0</sub></sub> |  | 10  |     |     | ns    |
| DIN to SCLK Rise Setup Time   | t <sub>DS</sub>             |  | 12  |     |     | ns    |
| DIN to SCLK Rise Hold Time  | t <sub>DH</sub>             |  | 5   |     |     | ns    |
| SCLK Rise to DOUTDC1 Valid Propagation Delay  | t <sub>DO1</sub>            | C <sub>L</sub> = 20pF, UPIO <sub>-</sub> = DOUTDC1 mode  |     |     | 30  | ns    |
| SCLK Fall to DOUT <sub>-</sub> Valid Propagation Delay                                      | t <sub>DO2</sub>            | C <sub>L</sub> = 20pF, UPIO <sub>-</sub> = DOUTDC0 or DOUTRB mode  |     |     | 30  | ns    |
| $\overline{\text{CS}}$ Rise to SCLK Rise Hold Time  | t <sub>CS1</sub>            | MICROWIRE and SPI modes 0 and 3  | 10  |     |     | ns    |
| $\overline{\text{CS}}$ Pulse-Width High   | t <sub>CSW</sub>            |  | 45  |     |     | ns    |
| <b>UPIO<sub>-</sub> TIMING CHARACTERISTICS</b>  |                             |  |     |     |     |       |
| DOUT Tri-State Time when Exiting DOUTDC0, DOUTDC1, and UPIO Modes                           | t <sub>DOZ</sub>            | C <sub>L</sub> = 20pF, from end of write cycle to UPIO <sub>-</sub> in high impedance                    |     |     | 100 | ns    |
| DOUTRB Tri-State Time from $\overline{\text{CS}}$ Rise                                      | t <sub>DRBZ</sub>           | C <sub>L</sub> = 20pF, from rising edge of $\overline{\text{CS}}$ to UPIO <sub>-</sub> in high impedance |     |     | 20  | ns    |
| DOUTRB Tri-State Enable Time from 8th SCLK Rise   | t <sub>ZEN</sub>            | C <sub>L</sub> = 20pF, from 8th rising edge of SCLK to UPIO <sub>-</sub> driven out of tri-state         | 0   |     |     | ns    |
| $\overline{\text{LDAC}}$ Pulse-Width Low  | t <sub>LDL</sub>            | Figure 5   | 20  |     |     | ns    |
| $\overline{\text{LDAC}}$ Effective Delay  | t <sub>LDS</sub>            | Figure 6   | 100 |     |     | ns    |
| $\overline{\text{CLR}}$ , $\overline{\text{MID}}$ , $\overline{\text{SET}}$ Pulse-Width Low | t <sub>CMS</sub>            | Figure 5   | 20  |     |     | ns    |
| GPO Output Settling Time  | t <sub>GP</sub>             | Figure 6   |     |     | 100 | ns    |
| GPO Output High-Impedance Time  | t <sub>GPZ</sub>            |  |     |     | 100 | ns    |

# Buffered, Fast-Settling, Quad, 12-/10-/8-Bit, Voltage-Output DACs

## TIMING CHARACTERISTICS—DSP Mode Disabled (1.8V Logic) (Figure 1)

(DV<sub>DD</sub> = 1.8V to 2.7V, AGND = DGND = 0, T<sub>A</sub> = T<sub>MIN</sub> to T<sub>MAX</sub>, unless otherwise noted.)

| PARAMETER   | SYMBOL            | CONDITIONS   | MIN | TYP | MAX | UNITS |
|---|-------------------|--|-----|-----|-----|-------|
| SCLK Frequency  | f <sub>SCLK</sub> | 1.8V < DV <sub>DD</sub> < 2.7V   |     |     | 10  | MHz   |
| SCLK Pulse-Width High   | t <sub>CH</sub>   | (Note 7)   | 40  |     |     | ns    |
| SCLK Pulse-Width Low  | t <sub>CL</sub>   | (Note 7)   | 40  |     |     | ns    |
| $\overline{\text{CS}}$ Fall to SCLK Rise Setup Time   | t <sub>CSS</sub>  |  | 20  |     |     | ns    |
| SCLK Rise to $\overline{\text{CS}}$ Rise Hold Time  | t <sub>CSH</sub>  |  | 5   |     |     | ns    |
| SCLK Rise to $\overline{\text{CS}}$ Fall Setup Time   | t <sub>CS0</sub>  |  | 10  |     |     | ns    |
| DIN to SCLK Rise Setup Time   | t <sub>DS</sub>   |  | 20  |     |     | ns    |
| DIN to SCLK Rise Hold Time  | t <sub>DH</sub>   |  | 5   |     |     | ns    |
| SCLK Rise to DOUTDC1 Valid Propagation Delay  | t <sub>DO1</sub>  | C <sub>L</sub> = 20pF, UPIO <sub>-</sub> = DOUTDC1 mode  |     |     | 60  | ns    |
| SCLK Fall to DOUT <sub>-</sub> Valid Propagation Delay                                      | t <sub>DO2</sub>  | C <sub>L</sub> = 20pF, UPIO <sub>-</sub> = DOUTDC0 or DOUTRB mode  |     |     | 60  | ns    |
| $\overline{\text{CS}}$ Rise to SCLK Rise Hold Time  | t <sub>CS1</sub>  | MICROWIRE and SPI modes 0 and 3  | 20  |     |     | ns    |
| $\overline{\text{CS}}$ Pulse-Width High   | t <sub>CSW</sub>  |  | 90  |     |     | ns    |
| <b>UPIO<sub>-</sub> TIMING CHARACTERISTICS</b>  |                   |  |     |     |     |       |
| DOUT Tri-State Time when Exiting DOUTDC0, DOUTDC1, and UPIO Modes                           | t <sub>DOZ</sub>  | C <sub>L</sub> = 20pF, from end of write cycle to UPIO <sub>-</sub> in high impedance                    |     |     | 200 | ns    |
| DOUTRB Tri-State Time from $\overline{\text{CS}}$ Rise                                      | t <sub>DRBZ</sub> | C <sub>L</sub> = 20pF, from rising edge of $\overline{\text{CS}}$ to UPIO <sub>-</sub> in high impedance |     |     | 40  | ns    |
| DOUTRB Tri-State Enable Time from 8th SCLK Rise   | t <sub>ZEN</sub>  | C <sub>L</sub> = 20pF, from 8th rising edge of SCLK to UPIO <sub>-</sub> driven out of tri-state         | 0   |     |     | ns    |
| $\overline{\text{LDAC}}$ Pulse-Width Low  | t <sub>LDL</sub>  | Figure 5   | 40  |     |     | ns    |
| $\overline{\text{LDAC}}$ Effective Delay  | t <sub>LDS</sub>  | Figure 6   | 200 |     |     | ns    |
| $\overline{\text{CLR}}$ , $\overline{\text{MID}}$ , $\overline{\text{SET}}$ Pulse-Width Low | t <sub>CMS</sub>  | Figure 5   | 40  |     |     | ns    |
| GPO Output Settling Time  | t <sub>GP</sub>   | Figure 6   |     |     | 200 | ns    |
| GPO Output High-Impedance Time  | t <sub>GPZ</sub>  |  |     |     | 200 | ns    |

MAX5580-MAX5585

# Buffered, Fast-Settling, Quad, 12-/10-/8-Bit, Voltage-Output DACs

## TIMING CHARACTERISTICS—DSP Mode Enabled (3V, 3.3V, 5V Logic) (Figure 2)

(DV<sub>DD</sub> = 2.7V to 5.25V, AGND = DGND = 0, T<sub>A</sub> = T<sub>MIN</sub> to T<sub>MAX</sub>, unless otherwise noted.)

| PARAMETER   | SYMBOL             | CONDITIONS   | MIN | TYP | MAX | UNITS |
|---|--------------------|--|-----|-----|-----|-------|
| SCLK Frequency  | f <sub>SCLK</sub>  | 2.7V < DV <sub>DD</sub> < 5.25V  |     |     | 20  | MHz   |
| SCLK Pulse-Width High   | t <sub>CH</sub>    | (Note 7)   | 20  |     |     | ns    |
| SCLK Pulse-Width Low  | t <sub>CL</sub>    | (Note 7)   | 20  |     |     | ns    |
| $\overline{\text{CS}}$ Fall to SCLK Fall Setup Time   | t <sub>css</sub>   |  | 10  |     |     | ns    |
| DSP Fall to SCLK Fall Setup Time  | t <sub>DSS</sub>   |  | 10  |     |     | ns    |
| SCLK Fall to $\overline{\text{CS}}$ Rise Hold Time  | t <sub>CSH</sub>   |  | 5   |     |     | ns    |
| SCLK Fall to $\overline{\text{CS}}$ Fall Delay  | t <sub>CS0</sub>   |  | 10  |     |     | ns    |
| SCLK Fall to DSP Fall Delay   | t <sub>DS0</sub>   |  | 10  |     |     | ns    |
| DIN to SCLK Fall Setup Time   | t <sub>DS</sub>    |  | 12  |     |     | ns    |
| DIN to SCLK Fall Hold Time  | t <sub>DH</sub>    |  | 5   |     |     | ns    |
| SCLK Rise to DOUT_ Valid Propagation Delay  | t <sub>DO1</sub>   | C <sub>L</sub> = 20pF, UPIO_ = DOUTDC1 or DOUTRB mode  |     |     | 30  | ns    |
| SCLK Fall to DOUT_ Valid Propagation Delay  | t <sub>DO2</sub>   | C <sub>L</sub> = 20pF, UPIO_ = DOUTDC0 mode  |     |     | 30  | ns    |
| $\overline{\text{CS}}$ Rise to SCLK Fall Hold Time  | t <sub>CS1</sub>   | MICROWIRE and SPI modes 0 and 3  | 10  |     |     | ns    |
| $\overline{\text{CS}}$ Pulse-Width High   | t <sub>CSW</sub>   |  | 45  |     |     | ns    |
| DSP Pulse-Width High  | t <sub>DSW</sub>   |  | 20  |     |     | ns    |
| DSP Pulse-Width Low   | t <sub>DSPWL</sub> | (Note 8)   | 20  |     |     | ns    |
| <b>UPIO_ TIMING CHARACTERISTICS</b>   |                    |  |     |     |     |       |
| DOUT Tri-State Time when Exiting DOUTDC0, DOUTDC1, and UPIO Modes                           | t <sub>DOZ</sub>   | C <sub>L</sub> = 20pF, from end of write cycle to UPIO_ in high impedance                    |     |     | 100 | ns    |
| DOUTRB Tri-State Time from $\overline{\text{CS}}$ Rise                                      | t <sub>DRBZ</sub>  | C <sub>L</sub> = 20pF, from rising edge of $\overline{\text{CS}}$ to UPIO_ in high impedance |     |     | 20  | ns    |
| DOUTRB Tri-State Enable Time from 8th SCLK Fall   | t <sub>ZEN</sub>   | C <sub>L</sub> = 20pF, from 8th falling edge of SCLK to UPIO_ driven out of tri-state        | 0   |     |     | ns    |
| $\overline{\text{LDAC}}$ Pulse-Width Low  | t <sub>LDL</sub>   | Figure 5   | 20  |     |     | ns    |
| $\overline{\text{LDAC}}$ Effective Delay  | t <sub>LDS</sub>   | Figure 6   | 100 |     |     | ns    |
| $\overline{\text{CLR}}$ , $\overline{\text{MID}}$ , $\overline{\text{SET}}$ Pulse-Width Low | t <sub>CMS</sub>   | Figure 5   | 20  |     |     | ns    |
| GPO Output Settling Time  | t <sub>GP</sub>    | Figure 6   |     |     | 100 | ns    |
| GPO Output High-Impedance Time  | t <sub>GPZ</sub>   |  |     |     | 100 | ns    |

# Buffered, Fast-Settling, Quad, 12-/10-/8-Bit, Voltage-Output DACs

MAX5580-MAX5585

## TIMING CHARACTERISTICS—DSP Mode Enabled (1.8V Logic) (Figure 2)

(DV<sub>DD</sub> = 1.8V to 2.7V, AGND = DGND = 0, T<sub>A</sub> = T<sub>MIN</sub> to T<sub>MAX</sub>, unless otherwise noted.)

| PARAMETER   | SYMBOL             | CONDITIONS   | MIN | TYP | MAX | UNITS |
|---|--------------------|--|-----|-----|-----|-------|
| SCLK Frequency  | f <sub>SCLK</sub>  | 1.8V < DV <sub>DD</sub> < 2.7V   |     |     | 10  | MHz   |
| SCLK Pulse-Width High   | t <sub>CH</sub>    | (Note 7)   | 40  |     |     | ns    |
| SCLK Pulse-Width Low  | t <sub>CL</sub>    | (Note 7)   | 40  |     |     | ns    |
| $\overline{\text{CS}}$ Fall to SCLK Fall Setup Time   | t <sub>CSS</sub>   |  | 20  |     |     | ns    |
| $\overline{\text{DSP}}$ Fall to SCLK Fall Setup Time  | t <sub>DSS</sub>   |  | 20  |     |     | ns    |
| SCLK Fall to $\overline{\text{CS}}$ Rise Hold Time  | t <sub>CSH</sub>   |  | 5   |     |     | ns    |
| SCLK Fall to $\overline{\text{CS}}$ Fall Delay  | t <sub>CS0</sub>   |  | 10  |     |     | ns    |
| SCLK Fall to $\overline{\text{DSP}}$ Fall Delay   | t <sub>DS0</sub>   |  | 15  |     |     | ns    |
| DIN to SCLK Fall Setup Time   | t <sub>DS</sub>    |  | 20  |     |     | ns    |
| DIN to SCLK Fall Hold Time  | t <sub>DH</sub>    |  | 5   |     |     | ns    |
| SCLK Rise to DOUT_ Valid Propagation Delay  | t <sub>DO1</sub>   | C <sub>L</sub> = 20pF, UPIO_ = DOUTDC1 or DOUTRB mode  |     |     | 60  | ns    |
| SCLK Fall to DOUT_ Valid Propagation Delay  | t <sub>DO2</sub>   | C <sub>L</sub> = 20pF, UPIO_ = DOUTDC0 mode  |     |     | 60  | ns    |
| $\overline{\text{CS}}$ Rise to SCLK Fall Hold Time  | t <sub>CS1</sub>   | MICROWIRE and SPI modes 0 and 3  | 20  |     |     | ns    |
| $\overline{\text{CS}}$ Pulse-Width High   | t <sub>CSW</sub>   |  | 90  |     |     | ns    |
| $\overline{\text{DSP}}$ Pulse-Width High  | t <sub>DSW</sub>   |  | 40  |     |     | ns    |
| $\overline{\text{DSP}}$ Pulse-Width Low   | t <sub>DSPWL</sub> | (Note 8)   | 40  |     |     | ns    |
| <b>UPIO_ TIMING CHARACTERISTICS</b>   |                    |  |     |     |     |       |
| DOUT Tri-State Time when Exiting DOUTDC0, DOUTDC1, and UPIO Modes                           | t <sub>DOZ</sub>   | C <sub>L</sub> = 20pF, from end of write cycle to UPIO_ in high impedance                    |     |     | 200 | ns    |
| DOUTRB Tri-State Time from $\overline{\text{CS}}$ Rise                                      | t <sub>DRBZ</sub>  | C <sub>L</sub> = 20pF, from rising edge of $\overline{\text{CS}}$ to UPIO_ in high impedance |     |     | 40  | ns    |
| DOUTRB Tri-State Enable Time from 8th SCLK Fall   | t <sub>ZEN</sub>   | C <sub>L</sub> = 20pF, from 8th falling edge of SCLK to UPIO_ driven out of tri-state        | 0   |     |     | ns    |
| $\overline{\text{LDAC}}$ Pulse-Width Low  | t <sub>LDL</sub>   | Figure 5   | 40  |     |     | ns    |
| $\overline{\text{LDAC}}$ Effective Delay  | t <sub>LDS</sub>   | Figure 6   | 200 |     |     | ns    |
| $\overline{\text{CLR}}$ , $\overline{\text{MID}}$ , $\overline{\text{SET}}$ Pulse-Width Low | t <sub>CMS</sub>   | Figure 5   | 40  |     |     | ns    |
| GPO Output Settling Time  | t <sub>GP</sub>    | Figure 6   |     |     | 200 | ns    |
| GPO Output High-Impedance Time  | t <sub>GPZ</sub>   |  |     |     | 200 | ns    |

**Note 7:** In some daisy-chain modes, data is required to be clocked in on one clock edge and the shifted data clocked out on the following edge. In the case of a 0.5 clock-period delay, it is necessary to increase the minimum high/low clock times to 25ns (2.7V) or 50ns (1.8V).

**Note 8:** The falling edge of  $\overline{\text{DSP}}$  starts a DSP-type bus cycle, provided that  $\overline{\text{CS}}$  is also active low to select the device.  $\overline{\text{DSP}}$  active low and  $\overline{\text{CS}}$  active low must overlap by a minimum of 10ns (2.7V) or 20ns (1.8V).  $\overline{\text{CS}}$  can be permanently low in this mode of operation.

# Buffered, Fast-Settling, Quad, 12-/10-/8-Bit, Voltage-Output DACs

## Typical Operating Characteristics

( $V_{DD} = DV_{DD} = 5V$ ,  $V_{REF} = 4.096V$ ,  $R_L = 10k\Omega$ ,  $C_L = 100pF$ , speed mode = FAST, PU = floating,  $T_A = +25^\circ C$ , unless otherwise noted.)

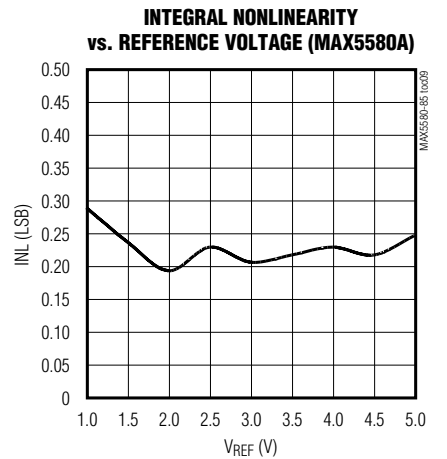
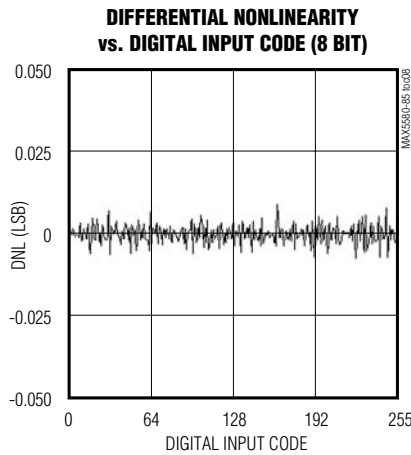
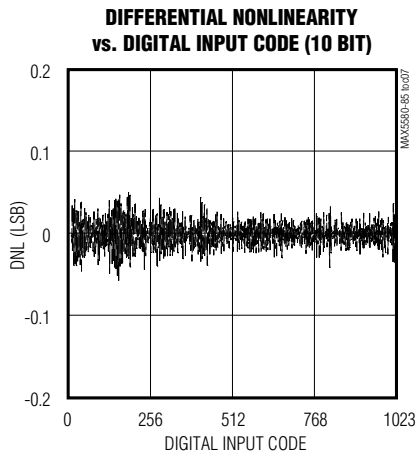
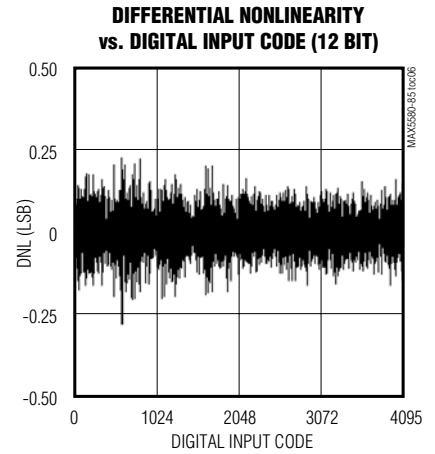
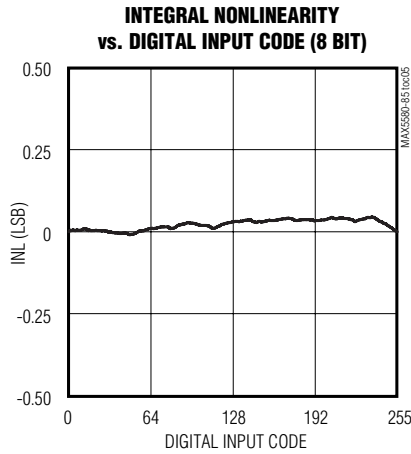
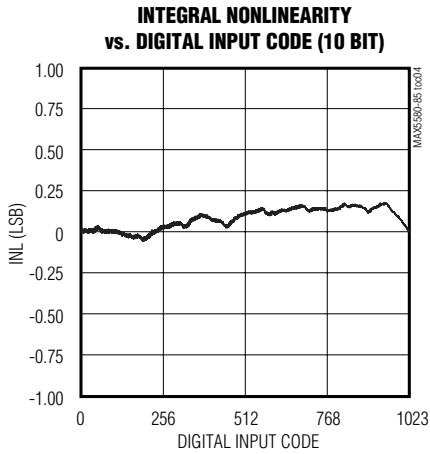
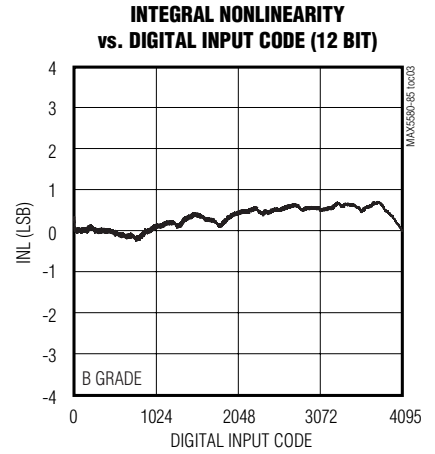
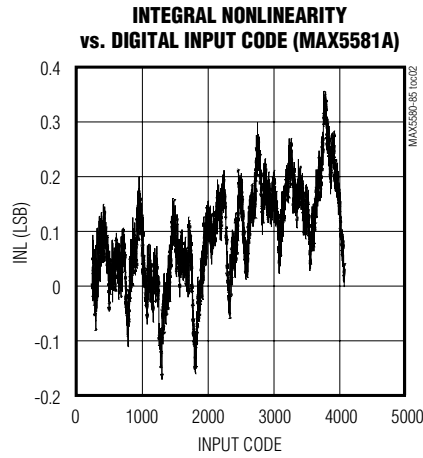
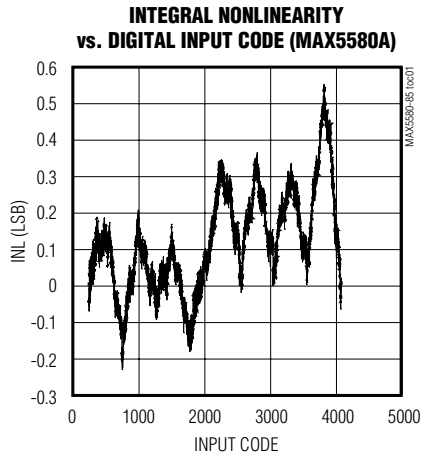

# Buffered, Fast-Settling, Quad, 12-/10-/8-Bit, Voltage-Output DACs

## Typical Operating Characteristics (continued)

( $V_{DD} = DV_{DD} = 5V$ ,  $V_{REF} = 4.096V$ ,  $R_L = 10k\Omega$ ,  $C_L = 100pF$ , speed mode = FAST, PU = floating,  $T_A = +25^\circ C$ , unless otherwise noted.)

MAX5580-MAX5585

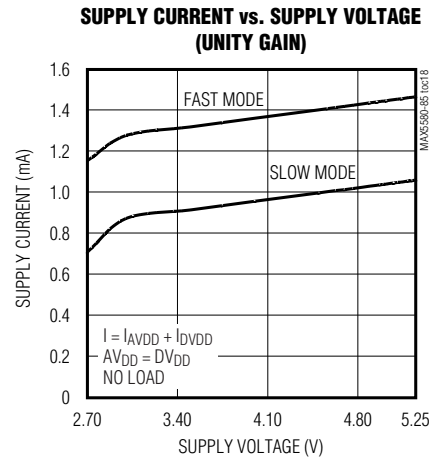
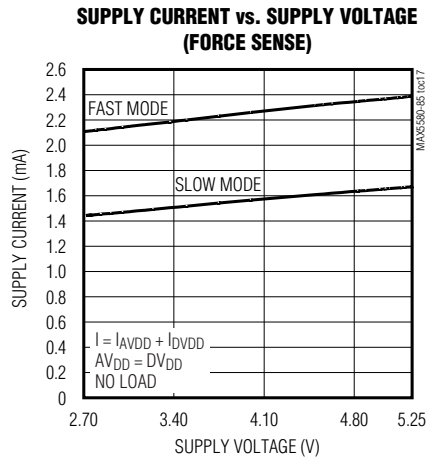
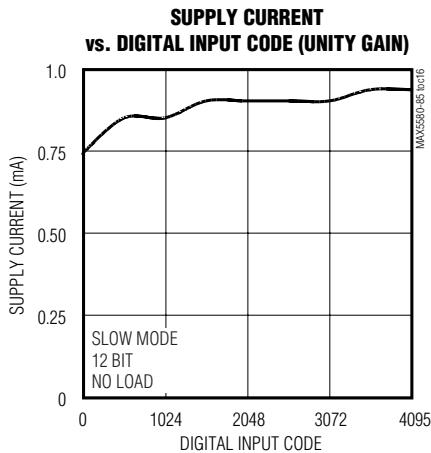
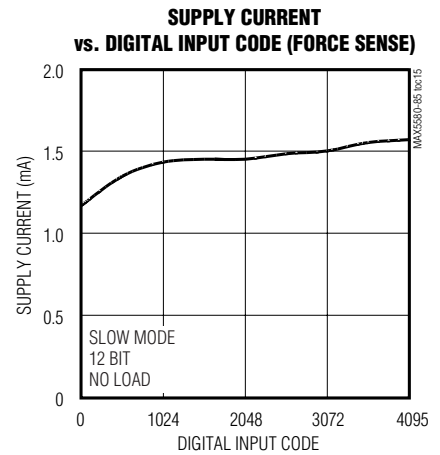
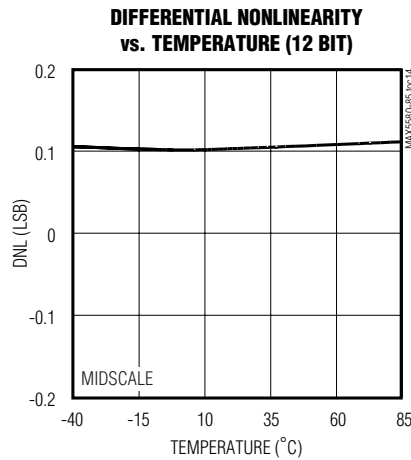
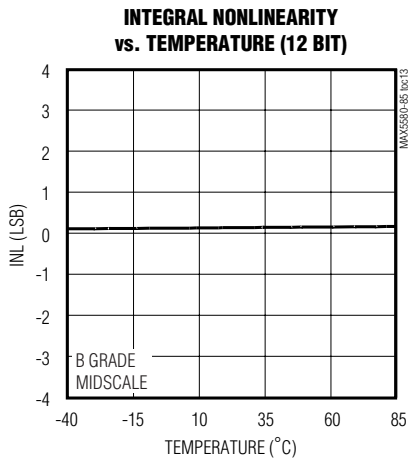
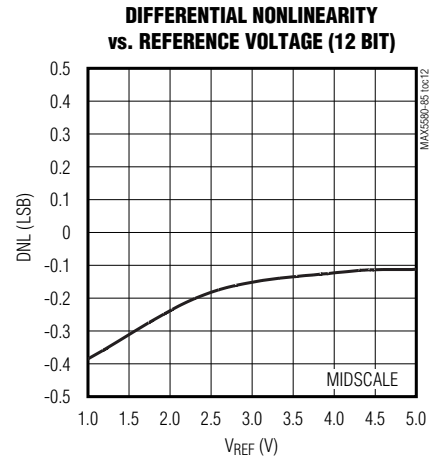
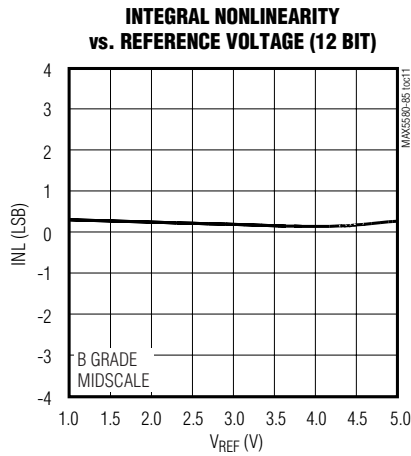
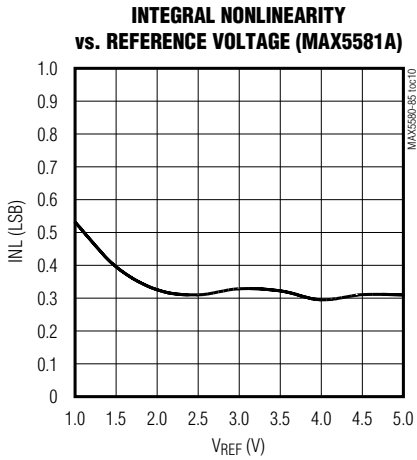

# Buffered, Fast-Settling, Quad, 12-/10-/8-Bit, Voltage-Output DACs

## Typical Operating Characteristics (continued)

( $V_{DD} = DV_{DD} = 5V$ ,  $V_{REF} = 4.096V$ ,  $R_L = 10k\Omega$ ,  $C_L = 100pF$ , speed mode = FAST, PU = floating,  $T_A = +25^\circ C$ , unless otherwise noted.)

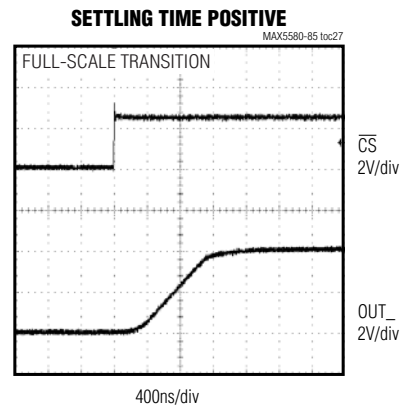
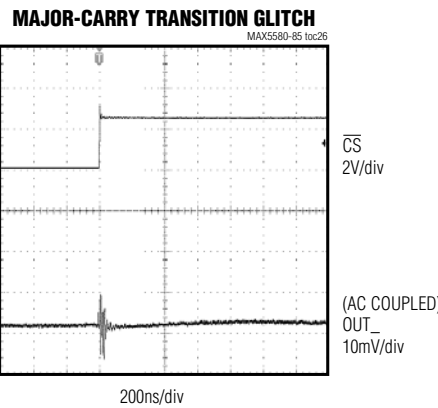
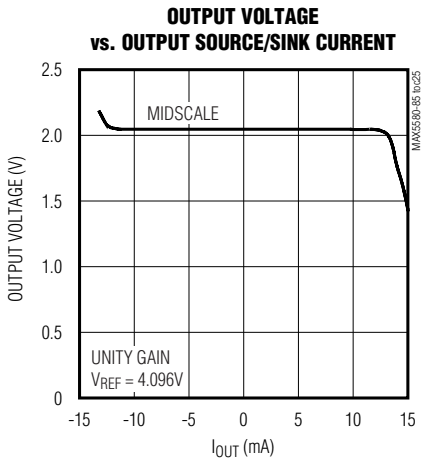
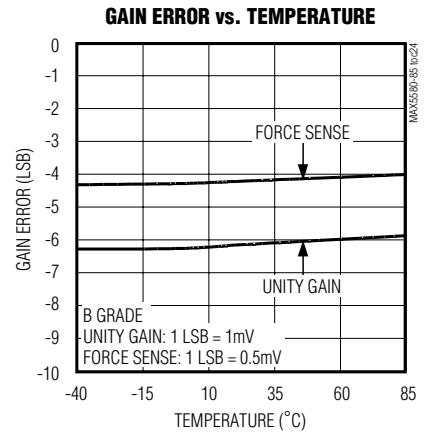
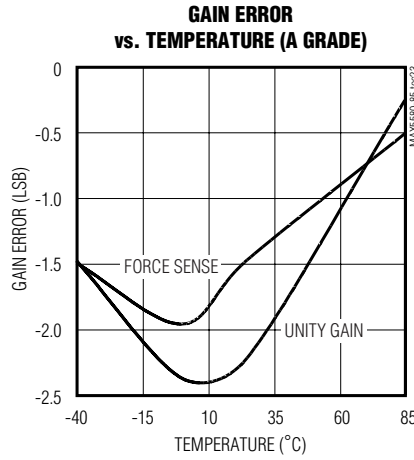
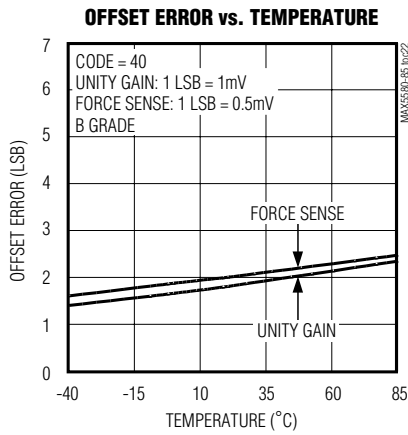
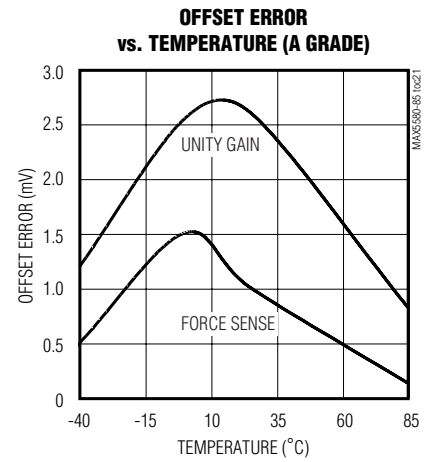
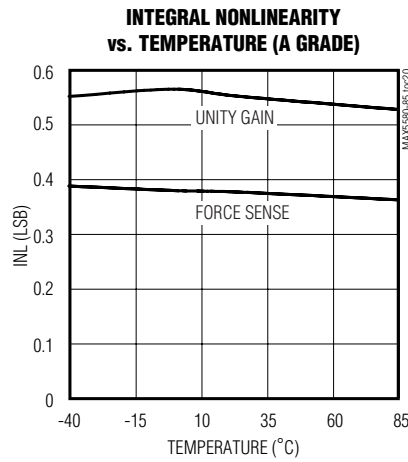
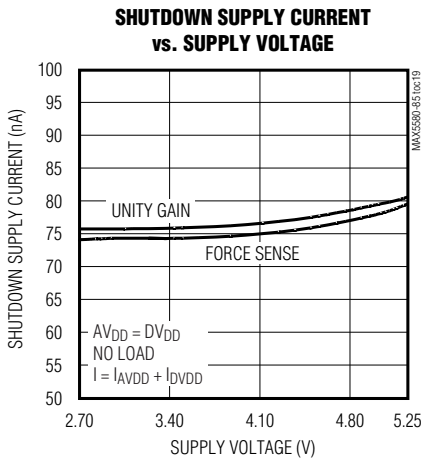

# Buffered, Fast-Settling, Quad, 12-/10-/8-Bit, Voltage-Output DACs

## Typical Operating Characteristics (continued)

( $A_{VDD} = DV_{DD} = 5V$ ,  $V_{REF} = 4.096V$ ,  $R_L = 10k\Omega$ ,  $C_L = 100pF$ , speed mode = FAST, PU = floating,  $T_A = +25^\circ C$ , unless otherwise noted.)

MAX5580-MAX5585

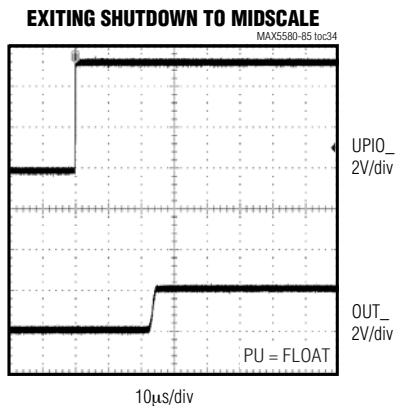
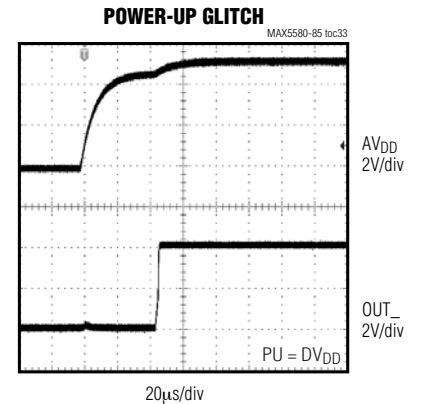
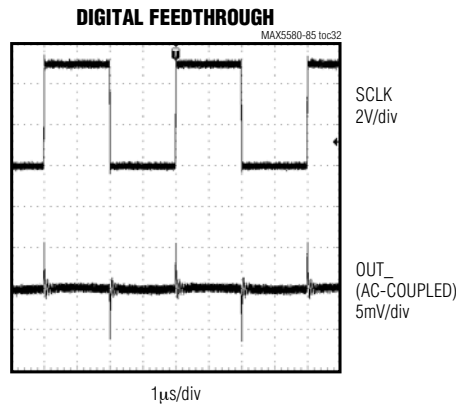
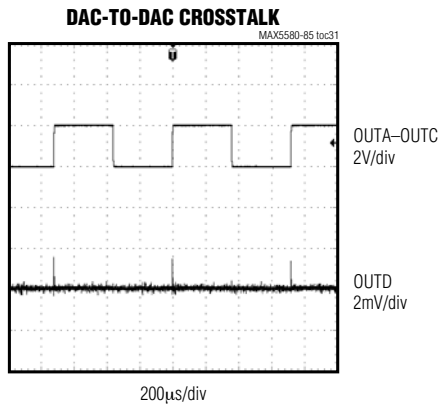
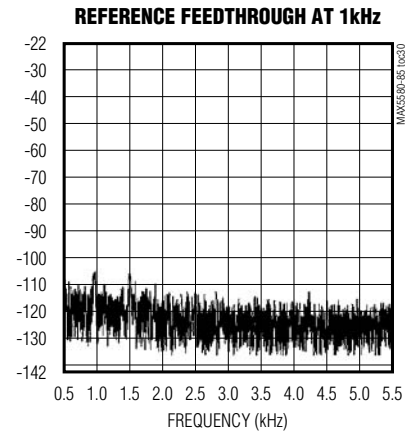
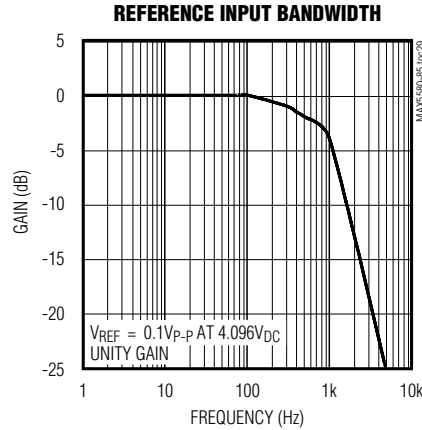
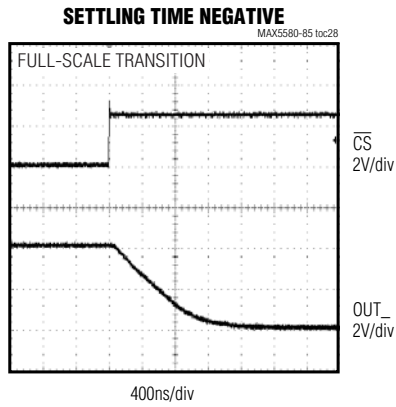

# Buffered, Fast-Settling, Quad, 12-/10-/8-Bit, Voltage-Output DACs

## Pin Description

| PIN                           |                               | NAME                    | FUNCTION   |
|-------------------------------|-------------------------------|-------------------------|--|
| MAX5580<br>MAX5582<br>MAX5584 | MAX5581<br>MAX5583<br>MAX5585 |                         |  |
| 1                             | 1                             | AGND                    | Analog Ground  |
| 2                             | 2                             | AVDD                    | Analog Supply  |
| 3, 5, 17, 19                  | —                             | N.C.                    | No Connection. Not internally connected.   |
| —                             | 3                             | FBB                     | Feedback for DACB  |
| 4                             | 4                             | OUTB                    | DACB Output  |
| —                             | 5                             | FBA                     | Feedback for DACA  |
| 6                             | 6                             | OUTA                    | DACA Output  |
| 7                             | 7                             | PU                      | Power-Up State Select Input. Connect PU to DVDD to set OUT_ to full scale upon power-up. Connect PU to DGND to set OUT_ to zero scale upon power-up. Float PU to set OUT_ to midscale upon power-up. |
| 8                             | 8                             | $\overline{\text{CS}}$  | Active-Low Chip-Select Input   |
| 9                             | 9                             | SCLK                    | Serial Clock Input   |
| 10                            | 10                            | DIN                     | Serial Data Input  |
| 11                            | 11                            | UPIO1                   | User-Programmable Input/Output 1   |
| 12                            | 12                            | UPIO2                   | User-Programmable Input/Output 2   |
| 13                            | 13                            | DVDD                    | Digital Supply   |
| 14                            | 14                            | DGND                    | Digital Ground   |
| 15                            | 15                            | $\overline{\text{DSP}}$ | Clock Enable. Connect $\overline{\text{DSP}}$ to DVDD to clock in data on the rising edge of SCLK. Connect $\overline{\text{DSP}}$ to DGND to clock in data on the falling edge of SCLK.             |
| 16                            | 16                            | OUTD                    | DACD Output  |
| —                             | 17                            | FBD                     | Feedback for DACD  |
| 18                            | 18                            | OUTC                    | DACC Output  |
| —                             | 19                            | FBC                     | Feedback for DACC  |
| 20                            | 20                            | REF                     | Reference Input  |
| —                             | —                             | EP                      | Exposed Pad. Connect to AGND.  |

# Buffered, Fast-Settling, Quad, 12-/10-/8-Bit, Voltage-Output DACs

## Functional Diagrams

MAX5580-MAX5585

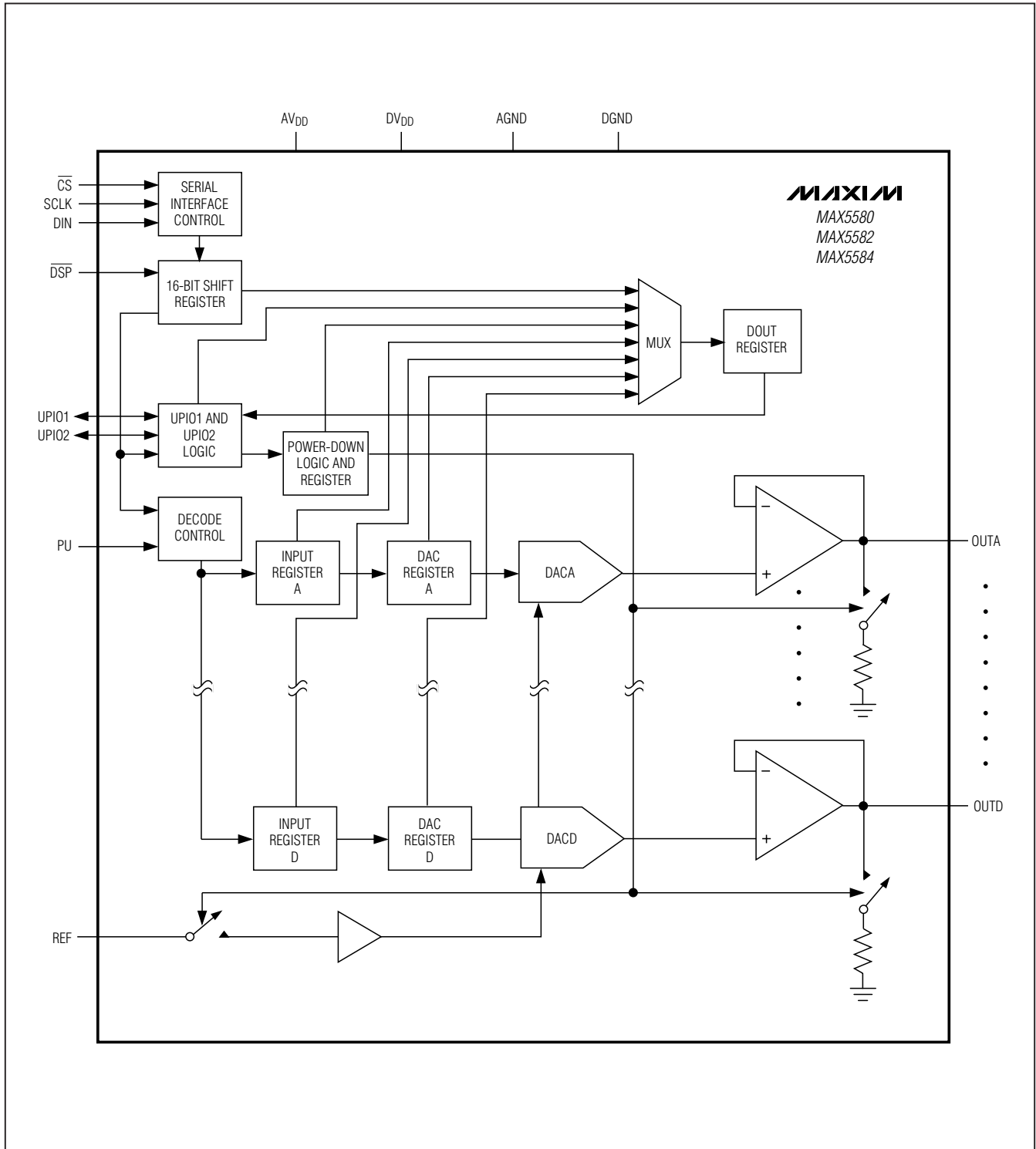

# Buffered, Fast-Settling, Quad, 12-/10-/8-Bit, Voltage-Output DACs

Functional Diagrams (continued)

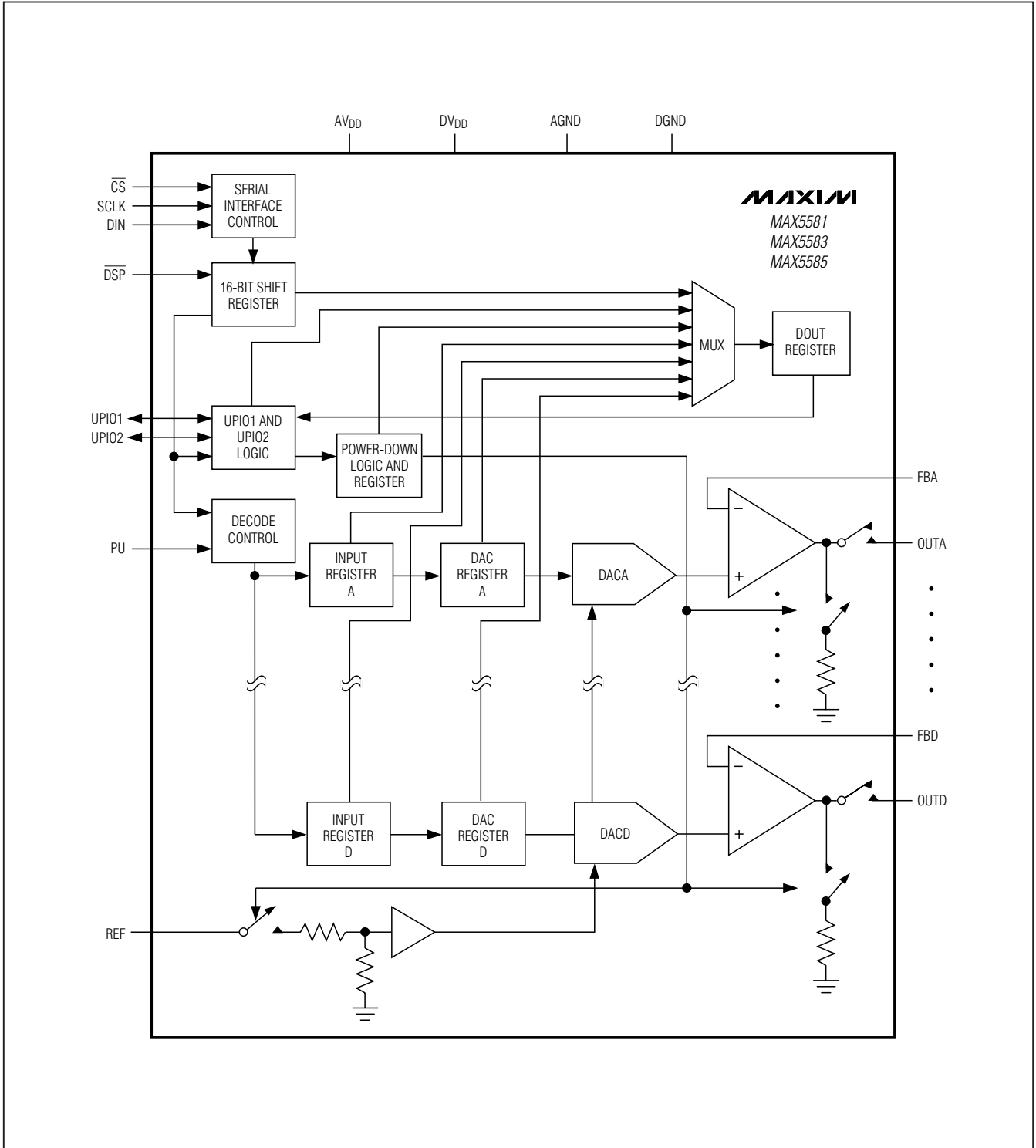

# Buffered, Fast-Settling, Quad, 12-/10-/8-Bit, Voltage-Output DACs

## Detailed Description

The MAX5580-MAX5585 quad, 12-/10-/8-bit, voltage-output DACs offer buffered outputs and a 3 $\mu$ s maximum settling time at the 12-bit level. The DACs operate from a single 2.7V to 5.25V analog supply and a separate 1.8V to AV<sub>DD</sub> digital supply. The MAX5580-MAX5585 include an input register and DAC register for each channel and a 16-bit data-in/data-out shift register. The 3-wire serial interface is compatible with SPI, QSPI, MICROWIRE, and DSP applications. The MAX5580-MAX5585 provide two user-programmable digital I/O ports, which are programmed through the serial interface. The externally selectable power-up states of the DAC outputs are either zero scale, midscale, or full scale.

### Reference Input

The reference input, REF, accepts both AC and DC values with a voltage range extending from analog ground (AGND) to AV<sub>DD</sub>. The voltage at REF sets the full-scale output of the DACs. Determine the output voltage using the following equations:

Unity-gain versions:

$$V_{OUT\_} = (V_{REF} \times CODE) / 2^N$$

Force-sense versions (FB<sub>-</sub> connected to OUT<sub>-</sub>):

$$V_{OUT} = 0.5 \times (V_{REF} \times CODE) / 2^N$$

where CODE is the numeric value of the DAC's binary input code and N is the bits of resolution. For the MAX5580/MAX5581, N = 12 and CODE ranges from 0 to 4095. For the MAX5582/MAX5583, N = 10 and CODE ranges from 0 to 1023. For the MAX5584/MAX5585, N = 8 and CODE ranges from 0 to 255. Use the miniature MAX6126 low-dropout, ultra-low-noise reference for optimum performance.

### Output Buffers

The DACA-DACD output-buffer amplifiers of the MAX5580-MAX5585 are unity-gain stable with rail-to-rail output voltage swings and a typical slew rate of 3.6V/ $\mu$ s (FAST mode). The MAX5580/MAX5582/MAX5584 provide unity-gain outputs, while the MAX5581/MAX5583/MAX5585 provide force-sense outputs. For the MAX5581/MAX5583/MAX5585, access to the output amplifier's inverting input provides flexibility in output gain setting and signal conditioning (see the *Applications Information* section).

The MAX5580-MAX5585 offer FAST and SLOW settling-time modes. In the SLOW mode, the settling time is 6 $\mu$ s (max), and the supply current is 1.6mA (max). In the FAST mode, the settling time is 3 $\mu$ s (max), and the supply current is 4mA (max). See the *Digital Interface* section for settling-time mode programming details.

Use the serial interface to set the shutdown output impedance of the amplifiers to 1k $\Omega$  or 100k $\Omega$  for the MAX5580/MAX5582/MAX5584 and 1k $\Omega$  or high impedance for the MAX5581/MAX5583/MAX5585. The DAC outputs can drive a 10k $\Omega$  (typ) load and are stable with up to 500pF (typ) of capacitive load.

### Power-On Reset

At power-up, all DAC outputs power up to full scale, midscale, or zero scale, depending on the configuration of the PU input. Connect PU to DV<sub>DD</sub> to set OUT<sub>-</sub> to full scale upon power-up. Connect PU to digital ground (DGND) at power-up to set OUT<sub>-</sub> to zero scale. Leave PU floating to set OUT<sub>-</sub> to midscale.

### Digital Interface

The MAX5580-MAX5585 use a 3-wire serial interface that is compatible with SPI, QSPI, MICROWIRE, and DSP protocol applications (Figures 1 and 2). Connect  $\overline{DSP}$  to DV<sub>DD</sub> before power-up to clock data in on the rising edge of SCLK. Connect  $\overline{DSP}$  to DGND before power-up to clock data in on the falling edge of SCLK. After power-up, the device enters DSP frame-sync mode on the first rising edge of  $\overline{DSP}$ . Refer to the *MAX5580-MAX5585 Programmer's Handbook* for details.

The MAX5580-MAX5585 include a 16-bit input shift register. The data is loaded into the input shift register through the serial interface. The 16 bits can be sent in two serial 8-bit packets or one 16-bit word ( $\overline{CS}$  must remain low until all 16 bits are transferred). The data is loaded MSB first. For the MAX5580/MAX5581, the 16 bits consist of 4 control bits (C3-C0) and 12 data bits (D11-D0) (see Table 1). For the 10-bit MAX5582/MAX5583 devices, D11-D2 are the data bits and D1 and D0 are sub-bits. For the 8-bit MAX5584/MAX5585 devices, D11-D4 are the data bits and D3-D0 are sub-bits. Set all sub-bits to zero for optimum performance.

Each DAC channel includes two registers: an input register and the DAC register. At power-up, the DAC output is set according to the state of PU. The DACs are double-buffered, which allows any of the following for each channel:

- Loading the input register without updating the DAC register
- Loading and updating the DAC register without updating the input register
- Updating the DAC register from the input register
- Updating the input and DAC registers simultaneously

# Buffered, Fast-Settling, Quad, 12-/10-/8-Bit, Voltage-Output DACs

Table 1. Serial Write Data Format

| MSB          |    |    |    | 16 BITS OF SERIAL DATA |     |    |    |    |    |    |    |    |    |    |    | LSB |
|--------------|----|----|----|------------------------|-----|----|----|----|----|----|----|----|----|----|----|-----|
| CONTROL BITS |    |    |    | DATA BITS              |     |    |    |    |    |    |    |    |    |    |    |     |
| C3           | C2 | C1 | C0 | D11                    | D10 | D9 | D8 | D7 | D6 | D5 | D4 | D3 | D2 | D1 | D0 |     |

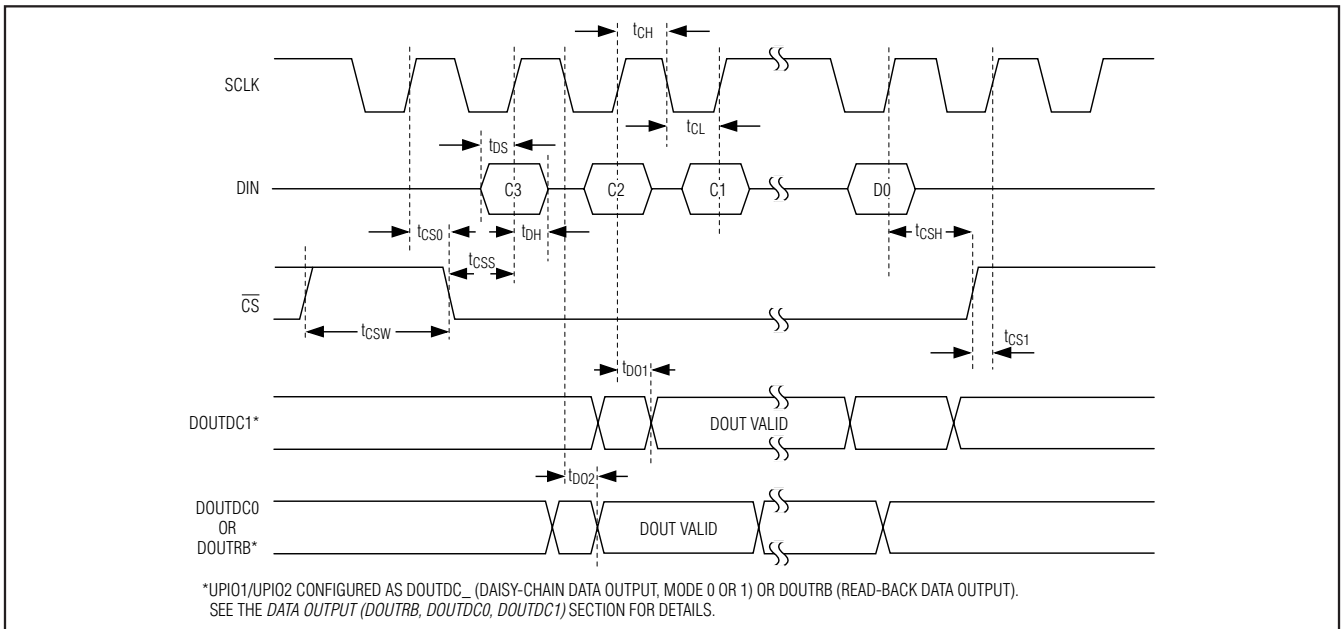

Figure 1. Serial-Interface Timing Diagram (DSP Mode Disabled)

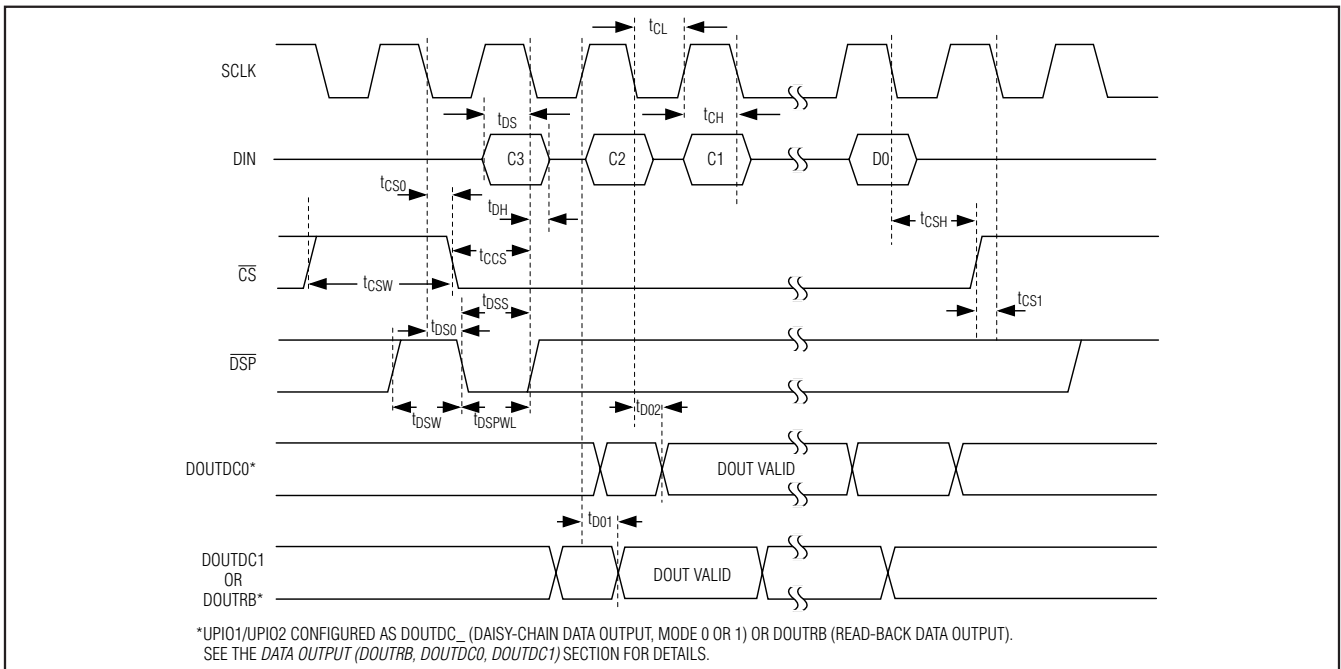

Figure 2. Serial-Interface Timing Diagram (DSP Mode Enabled)

# Buffered, Fast-Settling, Quad, 12-/10-/8-Bit, Voltage-Output DACs

## Serial-Interface Programming Commands

Tables 2a, 2b, and 2c provide all the serial-interface programming commands for the MAX5580-MAX5585. Table 2a shows the basic DAC programming commands, Table 2b gives the advanced-feature programming commands, and Table 2c provides the 24-bit read commands. Figures 3 and 4 provide serial-interface diagrams for write operations.

## Loading Input and DAC Registers

The MAX5580-MAX5585 contain a 16-bit shift register that is followed by a 12-bit input register and a 12-bit DAC register for each channel (see the *Functional Diagrams*). Tables 3, 4, and 5 highlight a few of the commands that handle the loading of the input and DAC registers. See Table 2a for all DAC programming commands.

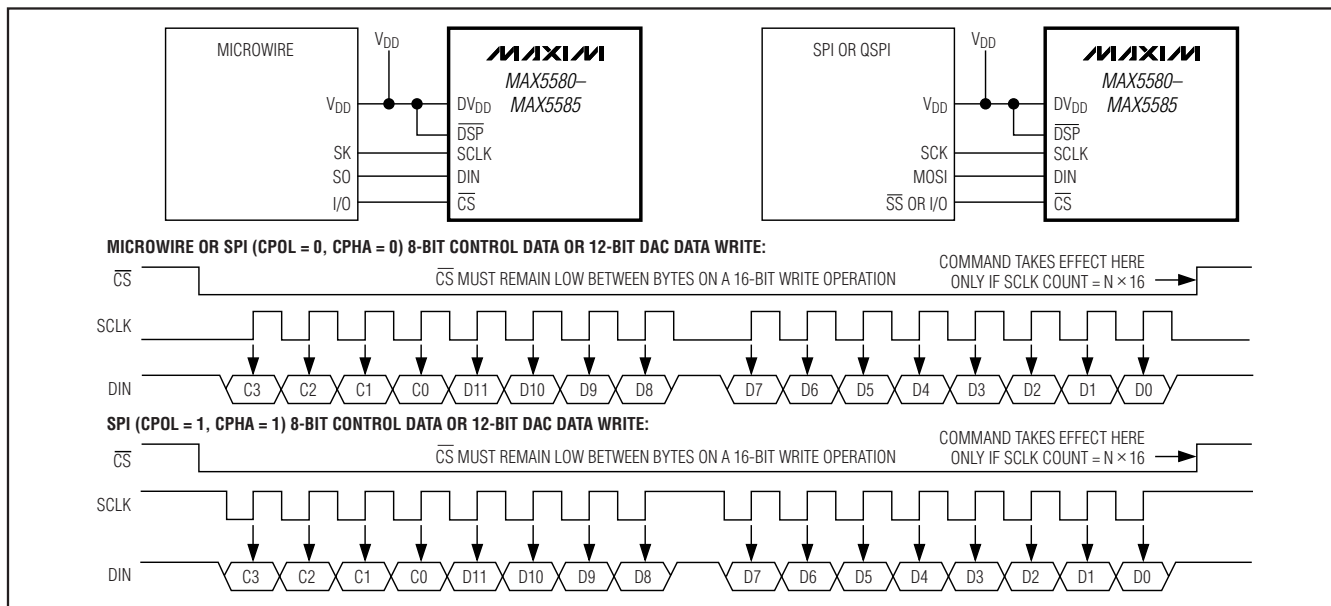

Figure 3. MICROWIRE and SPI Single DAC Writes (CPOL = 0, CPHA = 0 or CPOL = 1, CPHA = 1)

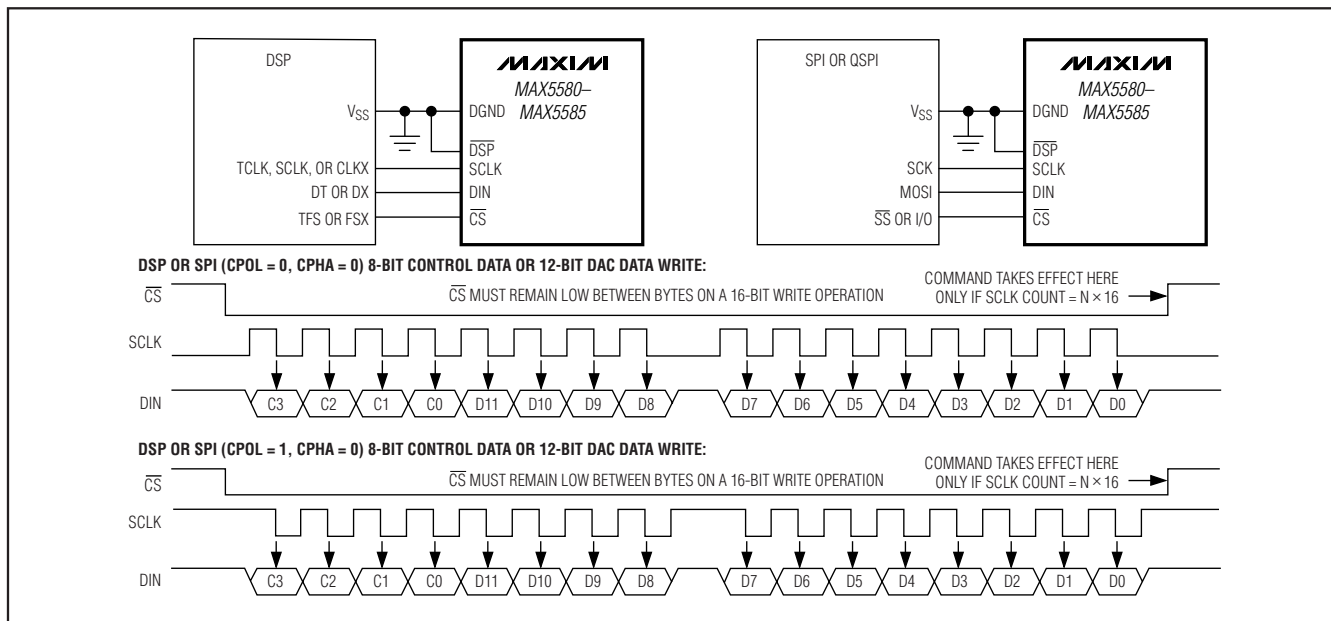

Figure 4. DSP and SPI Single DAC Writes (CPOL = 0, CPHA = 1 or CPOL = 1, CPHA = 0)

# Buffered, Fast-Settling, Quad, 12-/10-/8-Bit, Voltage-Output DACs

**Table 2a. DAC Programming Commands**

| DATA                         | CONTROL BITS |    |    |    | DATA BITS |     |    |    |    |    |    |    |      |      |      |      | FUNCTION  |
|------------------------------|--------------|----|----|----|-----------|-----|----|----|----|----|----|----|------|------|------|------|---|
|                              | C3           | C2 | C1 | C0 | D11       | D10 | D9 | D8 | D7 | D6 | D5 | D4 | D3   | D2   | D1   | D0   |   |
| <b>INPUT REGISTERS (A-D)</b> |              |    |    |    |           |     |    |    |    |    |    |    |      |      |      |      |   |
| DIN                          | 0            | 0  | 0  | 0  | D11       | D10 | D9 | D8 | D7 | D6 | D5 | D4 | D3/0 | D2/0 | D1/0 | D0/0 | Load DACA input register from shift register; DACA output register is unchanged; DACA output is unchanged.* |
| DIN                          | 0            | 0  | 0  | 1  | D11       | D10 | D9 | D8 | D7 | D6 | D5 | D4 | D3/0 | D2/0 | D1/0 | D0/0 | Load DACA output register from shift register; input register is unchanged; DACA output is updated.*        |
| DIN                          | 0            | 0  | 1  | 0  | D11       | D10 | D9 | D8 | D7 | D6 | D5 | D4 | D3/0 | D2/0 | D1/0 | D0/0 | Load DACA input register and output register from shift register; DACA output is updated.*                  |
| DIN                          | 0            | 0  | 1  | 1  | D11       | D10 | D9 | D8 | D7 | D6 | D5 | D4 | D3/0 | D2/0 | D1/0 | D0/0 | Load DACB input register from shift register; DACB output register is unchanged; DACB output is unchanged.* |
| DIN                          | 0            | 1  | 0  | 0  | D11       | D10 | D9 | D8 | D7 | D6 | D5 | D4 | D3/0 | D2/0 | D1/0 | D0/0 | Load DACB output register from shift register; input register is unchanged. DACB output is updated.*        |
| DIN                          | 0            | 1  | 0  | 1  | D11       | D10 | D9 | D8 | D7 | D6 | D5 | D4 | D3/0 | D2/0 | D1/0 | D0/0 | Load DACB input register and output register from shift register; DACB output is updated.*                  |
| DIN                          | 0            | 1  | 1  | 0  | D11       | D10 | D9 | D8 | D7 | D6 | D5 | D4 | D3/0 | D2/0 | D1/0 | D0/0 | Load DACC input register from shift register; DACC output register is unchanged; DACC output is unchanged.* |
| DIN                          | 0            | 1  | 1  | 1  | D11       | D10 | D9 | D8 | D7 | D6 | D5 | D4 | D3/0 | D2/0 | D1/0 | D0/0 | Load DACC output register from shift register; input register is unchanged; DACC output is updated.*        |
| DIN                          | 1            | 0  | 0  | 0  | D11       | D10 | D9 | D8 | D7 | D6 | D5 | D4 | D3/0 | D2/0 | D1/0 | D0/0 | Load DACC input register and output register from shift register; DACC output is updated.*                  |
| DIN                          | 1            | 0  | 0  | 1  | D11       | D10 | D9 | D8 | D7 | D6 | D5 | D4 | D3/0 | D2/0 | D1/0 | D0/0 | Load DACD input register from shift register; DACD output register is unchanged; DACD output is unchanged.* |
| DIN                          | 1            | 0  | 1  | 0  | D11       | D10 | D9 | D8 | D7 | D6 | D5 | D4 | D3/0 | D2/0 | D1/0 | D0/0 | Load DACD output register from shift register; input register is unchanged; DACD output is updated.*        |

# Buffered, Fast-Settling, Quad, 12-/10-/8-Bit, Voltage-Output DACs

Table 2a. DAC Programming Commands (continued)

| DATA                         | CONTROL BITS |    |    | DATA BITS |     |     |    |    |    |    |    |    |      |      |      | FUNCTION |   |
|------------------------------|--------------|----|----|-----------|-----|-----|----|----|----|----|----|----|------|------|------|----------|---|
|                              | C3           | C2 | C1 | C0        | D11 | D10 | D9 | D8 | D7 | D6 | D5 | D4 | D3   | D2   | D1   |          | D0  |
| <b>INPUT REGISTERS (A-D)</b> |              |    |    |           |     |     |    |    |    |    |    |    |      |      |      |          |   |
| DIN                          | 1            | 0  | 1  | 1         | D11 | D10 | D9 | D8 | D7 | D6 | D5 | D4 | D3/0 | D2/0 | D1/0 | D0/0     | Load DACD input register and output register from shift register; DACD output is updated.*                                    |
| DIN                          | 1            | 1  | 0  | 0         | D11 | D10 | D9 | D8 | D7 | D6 | D5 | D4 | D3/0 | D2/0 | D1/0 | D0/0     | Load all DAC input registers from the shift register; all DAC output registers are unchanged; all DAC outputs are unchanged.* |
| DIN                          | 1            | 1  | 0  | 1         | D11 | D10 | D9 | D8 | D7 | D6 | D5 | D4 | D3/0 | D2/0 | D1/0 | D0/0     | Load all DAC input and output registers from shift register; DAC outputs are updated.*  |

\*For the MAX5582/MAX5583 (10-bit version), D11–D2 are the significant bits and D1 and D0 are sub-bits. For the MAX5584/MAX5585 (8-bit version), D11–D4 are the significant bits and D3–D0 are sub-bits. Set all sub-bits to zero during the write commands.

Table 2b. Advanced-Feature Programming Commands

| DATA                           | CONTROL BITS |    |    | DATA BITS |     |     |    |    |       |       |       |       |       |       |       | FUNCTION |   |    |  |
|--------------------------------|--------------|----|----|-----------|-----|-----|----|----|-------|-------|-------|-------|-------|-------|-------|----------|---|----|--|
|                                | C3           | C2 | C1 | C0        | D11 | D10 | D9 | D8 | D7    | D6    | D5    | D4    | D3    | D2    | D1    |          | D0  |    |  |
| <b>SELECT BITS</b>             |              |    |    |           |     |     |    |    |       |       |       |       |       |       |       |          |   |    |  |
| DIN                            | 1            | 1  | 1  | 0         | 0   | 0   | 0  | X  | X     | X     | X     | X     | X     | X     | MD    | MC       | MB  | MA | Load DAC_ output register from input register when M_ is one; DAC_ output register is unchanged if M_ is zero. |
| <b>SHUTDOWN-MODE BITS</b>      |              |    |    |           |     |     |    |    |       |       |       |       |       |       |       |          |   |    |  |
| DIN                            | 1            | 1  | 1  | 0         | 0   | 1   | 0  | X  | PDD1  | PDD0  | PDC1  | PDC0  | PDB1  | PDB0  | PDA1  | PDA0     | Write DAC_ shutdown-mode bits; see Table 8.       |    |  |
| DIN                            | 1            | 1  | 1  | 0         | 0   | 1   | 1  | X  | X     | X     | X     | X     | X     | X     | X     | X        | Read DAC_ shutdown-mode bits.                     |    |  |
| DOUTr                          | X            | X  | X  | X         | X   | X   | X  | X  | PDD1  | PDD0  | PDC1  | PDC0  | PDB1  | PDB0  | PDA1  | PDA0     |   |    |  |
| <b>UPIO CONFIGURATION BITS</b> |              |    |    |           |     |     |    |    |       |       |       |       |       |       |       |          |   |    |  |
| DIN                            | 1            | 1  | 1  | 0         | 1   | 0   | 0  | X  | UPSL2 | UPSL1 | UP3   | UP2   | UP1   | UP0   | X     | X        | Write UPIO configuration bits; see Table 18.      |    |  |
| DIN                            | 1            | 1  | 1  | 0         | 1   | 0   | 1  | X  | X     | X     | X     | X     | X     | X     | X     | X        | Read UPIO configuration bits.                     |    |  |
| DOUTr                          | X            | X  | X  | X         | X   | X   | X  | X  | UP3-2 | UP2-2 | UP1-2 | UP0-2 | UP3-1 | UP2-1 | UP1-1 | UP0-1    |   |    |  |
| <b>SETTLING-TIME-MODE BITS</b> |              |    |    |           |     |     |    |    |       |       |       |       |       |       |       |          |   |    |  |
| DIN                            | 1            | 1  | 1  | 0         | 1   | 1   | 0  | X  | X     | X     | X     | X     | SPDD  | SPDC  | SPDB  | SPDA     | Write DAC_ settling-time-mode bits; see Table 11. |    |  |

# Buffered, Fast-Settling, Quad, 12-/10-/8-Bit, Voltage-Output DACs

**Table 2b. Advanced-Feature Programming Commands (continued)**

| DATA                                       | CONTROL BITS |    |    |    | DATA BITS |     |    |    |    |      |     |     |      |      |      |      | Function                           |  |
|--|--------------|----|----|----|-----------|-----|----|----|----|------|-----|-----|------|------|------|------|------------------------------------|--|
|  | C3           | C2 | C1 | C0 | D11       | D10 | D9 | D8 | D7 | D6   | D5  | D4  | D3   | D2   | D1   | D0   |                                    |  |
| DIN  | 1            | 1  | 1  | 0  | 1         | 1   | 1  | X  | X  | X    | X   | X   | X    | X    | X    | X    | Read DAC_ settling-time-mode bits. |  |
| DOUTR                                      | X            | X  | X  | X  | X         | X   | X  | X  | X  | X    | X   | X   | SPDD | SPDC | SPDB | SPDA |                                    |  |
| <b>DAC CPOL/CPHA BITS</b>                  |              |    |    |    |           |     |    |    |    |      |     |     |      |      |      |      |                                    |  |
| DIN  | 1            | 1  | 1  | 1  | 0         | 0   | 0  | 0  | X  | X    | X   | X   | X    | X    | X    | CPOL | CPHA                               | Write CPOL, CPHA control bits.   |
| DIN  | 1            | 1  | 1  | 1  | 0         | 0   | 1  | 1  | X  | X    | X   | X   | X    | X    | X    | X    | X                                  | Read CPOL, CPHA control bits.  |
| DOUTR                                      | X            | X  | X  | X  | X         | X   | X  | X  | X  | X    | X   | X   | X    | X    | X    | CPOL | CPHA                               |  |
| <b>UPIO_AS GPI (GENERAL-PURPOSE INPUT)</b> |              |    |    |    |           |     |    |    |    |      |     |     |      |      |      |      |                                    |  |
| DIN  | 1            | 1  | 1  | 1  | 0         | 0   | 1  | X  | X  | X    | X   | X   | X    | X    | X    | X    | X                                  | Read UPIO_ inputs (valid only when UPIO1 or UPIO2 is configured as a general-purpose input); see Table 21. |
| DOUTRB                                     | X            | X  | X  | X  | X         | X   | X  | X  | X  | RTP2 | LF2 | LR2 | RTP1 | LF1  | LR1  |      |                                    |  |
| <b>OTHER COMMANDS</b>                      |              |    |    |    |           |     |    |    |    |      |     |     |      |      |      |      |                                    |  |
| DIN  | 1            | 1  | 1  | 1  | 1         | 1   | 0  | 0  | X  | X    | X   | X   | X    | X    | X    | X    | X                                  | Command is ignored.  |
| DIN  | 1            | 1  | 1  | 1  | 1         | 1   | 0  | 1  | X  | X    | X   | X   | X    | X    | X    | X    | X                                  | Command is ignored.  |
| DIN  | 1            | 1  | 1  | 1  | 1         | 1   | 0  | 1  | X  | X    | X   | X   | X    | X    | X    | X    | X                                  | Command is ignored.  |
| DIN  | 1            | 1  | 1  | 1  | 1         | 1   | 1  | 1  | 1  | 1    | 1   | 1   | 1    | 1    | 1    | 1    | 1                                  | 16-bit no-op command. all DACs are unaffected.   |

X = Don't care.

# Buffered, Fast-Settling, Quad, 12-/10-/8-Bit, Voltage-Output DACs

Table 2c. 24-Bit Read Commands

| DATA                             | CONTROL BITS |    |    |    |     |     |     |     | DATA BITS |     |     |     |     |     |     |     |     |     |     |     |     |     |    |    | FUNCTION |    |    |    |    |    |    |    |    |   |   |   |  |  |
|----------------------------------|--------------|----|----|----|-----|-----|-----|-----|-----------|-----|-----|-----|-----|-----|-----|-----|-----|-----|-----|-----|-----|-----|----|----|----------|----|----|----|----|----|----|----|----|---|---|---|--|--|
|                                  | C3           | C2 | C1 | C0 | D27 | D26 | D25 | D24 | D23       | D22 | D21 | D20 | D19 | D18 | D17 | D16 | D15 | D14 | D13 | D12 | D11 | D10 | D9 | D8 |          | D7 | D6 | D5 | D4 | D3 | D2 | D1 | D0 |   |   |   |  |  |
| READ INPUT AND DAC REGISTERS A–D |              |    |    |    |     |     |     |     |           |     |     |     |     |     |     |     |     |     |     |     |     |     |    |    |          |    |    |    |    |    |    |    |    |   |   |   |  |  |
| DIN                              | 1            | 1  | 1  | 1  | 0   | 1   | 0   | X   | 1         | 1   | 1   | 1   | 1   | 1   | 1   | 1   | 1   | 1   | 1   | 1   | 1   | 1   | 1  | 1  | 1        | 1  | 1  | 1  | 1  | 1  | 1  | 1  | 1  | 1 | 1 | 1 | X  | Read input register A and DAC register A (all 24 bits).**† |
| DOUTRB                           | X            | X  | X  | X  | X   | X   | X   | X   | X         | X   | X   | X   | X   | X   | X   | X   | X   | X   | X   | X   | X   | X   | X  | X  | X        | X  | X  | X  | X  | X  | X  | X  | X  | X | X | X | D0/X   |  |
| DIN                              | 1            | 1  | 1  | 1  | 0   | 1   | 1   | X   | 1         | 1   | 1   | 1   | 1   | 1   | 1   | 1   | 1   | 1   | 1   | 1   | 1   | 1   | 1  | 1  | 1        | 1  | 1  | 1  | 1  | 1  | 1  | 1  | 1  | 1 | 1 | 1 | X  | Read input register B and DAC register B (all 24 bits).**† |
| DOUTRB                           | X            | X  | X  | X  | X   | X   | X   | X   | X         | X   | X   | X   | X   | X   | X   | X   | X   | X   | X   | X   | X   | X   | X  | X  | X        | X  | X  | X  | X  | X  | X  | X  | X  | X | X | X | D0/X   |  |
| DIN                              | 1            | 1  | 1  | 1  | 1   | 0   | 0   | X   | 1         | 1   | 1   | 1   | 1   | 1   | 1   | 1   | 1   | 1   | 1   | 1   | 1   | 1   | 1  | 1  | 1        | 1  | 1  | 1  | 1  | 1  | 1  | 1  | 1  | 1 | 1 | X | Read input register C and DAC register C (all 24 bits).**† |  |
| DOUTRB                           | X            | X  | X  | X  | X   | X   | X   | X   | X         | X   | X   | X   | X   | X   | X   | X   | X   | X   | X   | X   | X   | X   | X  | X  | X        | X  | X  | X  | X  | X  | X  | X  | X  | X | X | X | D0/X   |  |
| DIN                              | 1            | 1  | 1  | 1  | 1   | 0   | 1   | X   | 1         | 1   | 1   | 1   | 1   | 1   | 1   | 1   | 1   | 1   | 1   | 1   | 1   | 1   | 1  | 1  | 1        | 1  | 1  | 1  | 1  | 1  | 1  | 1  | 1  | 1 | 1 | X | Read input register D and DAC register D (all 24 bits).**† |  |
| DOUTRB                           | X            | X  | X  | X  | X   | X   | X   | X   | X         | X   | X   | X   | X   | X   | X   | X   | X   | X   | X   | X   | X   | X   | X  | X  | X        | X  | X  | X  | X  | X  | X  | X  | X  | X | X | X | D0/X   |  |

X = Don't care.

\*\*D23–D12 represent the 12-bit data from the appropriate DAC output register. D11–D0 represent the 12-bit data from the corresponding input register. For the MAX5582/MAX5583, bits D13, D12, D1, and D0 are don't-care bits. For the MAX5584/MAX5585, bits D15–D12 and D3–D0 are don't-care bits.

†During readback, all ones (0xFF) must be clocked into DIN for all 24 bits. No command can be issued before all 24 bits have been clocked out. CS must be kept low while all 24 bits are clocked out.

# Buffered, Fast-Settling, Quad, 12-/10-/8-Bit, Voltage-Output DACs

## DAC Programming Examples:

To load input register A from the shift register, leaving DAC register A unchanged (DAC output unchanged), use the command in Table 3.

The MAX5580–MAX5585 can load all the input registers (A–D) simultaneously from the shift register, leaving the DAC registers unchanged (DAC output unchanged), by using the command in Table 4.

To load all the input registers (A–D) and all the DAC registers (A–D) simultaneously, use the command in Table 5.

For the 10-bit and 8-bit versions, set sub-bits = 0 for best performance.

## Advanced-Feature Programming Commands Select Bits (M<sub>l</sub>)

The select bits allow synchronous updating of any combination of channels. The select bits command the loading of the DAC register from the input register of each channel. Set the select bit M<sub>l</sub> = 1 to load the DAC register “\_” with data from the input register “\_”, where “\_” is replaced with A, B, C, or D, depending on the selected channel. Setting the select bit M<sub>l</sub> = 0 results in no action for that channel (Table 6).

### Select Bits Programming Example:

To load DAC register B from input register B while keeping other channels (A, C, D) unchanged, set MB = 1 and M<sub>l</sub> = 0 (Table 7).

**Table 3. Load Input Register A from Shift Register**

| DATA | CONTROL BITS |   |   |   | DATA BITS |     |    |    |    |    |    |    |      |      |      |      |
|------|--------------|---|---|---|-----------|-----|----|----|----|----|----|----|------|------|------|------|
| DIN  | 0            | 0 | 0 | 0 | D11       | D10 | D9 | D8 | D7 | D6 | D5 | D4 | D3/0 | D2/0 | D1/0 | D0/0 |

**Table 4. Load Input Registers (A–D) from Shift Register**

| DATA | CONTROL BITS |   |   |   | DATA BITS |     |    |    |    |    |    |    |      |      |      |      |
|------|--------------|---|---|---|-----------|-----|----|----|----|----|----|----|------|------|------|------|
| DIN  | 1            | 1 | 0 | 0 | D11       | D10 | D9 | D8 | D7 | D6 | D5 | D4 | D3/0 | D2/0 | D1/0 | D0/0 |

**Table 5. Load Input Registers (A–D) and DAC Registers (A–D) from Shift Register**

| DATA | CONTROL BITS |   |   |   | DATA BITS |     |    |    |    |    |    |    |      |      |      |      |
|------|--------------|---|---|---|-----------|-----|----|----|----|----|----|----|------|------|------|------|
| DIN  | 1            | 1 | 0 | 1 | D11       | D10 | D9 | D8 | D7 | D6 | D5 | D4 | D3/0 | D2/0 | D1/0 | D0/0 |

**Table 6. Select Bits (M<sub>l</sub>)**

| DATA | CONTROL BITS |   |   |   |   |   |   |   | DATA BITS |   |   |   |    |    |    |    |
|------|--------------|---|---|---|---|---|---|---|-----------|---|---|---|----|----|----|----|
| DIN  | 1            | 1 | 1 | 0 | 0 | 0 | X | X | X         | X | X | X | MD | MC | MB | MA |

X = Don't care.

**Table 7. Select Bits Programming Example**

| DATA | CONTROL BITS |   |   |   |   |   |   |   | DATA BITS |   |   |   |   |   |   |   |
|------|--------------|---|---|---|---|---|---|---|-----------|---|---|---|---|---|---|---|
| DIN  | 1            | 1 | 1 | 0 | 0 | 0 | X | X | X         | X | X | X | 0 | 0 | 1 | 0 |

X = Don't care.

# Buffered, Fast-Settling, Quad, 12-/10-/8-Bit, Voltage-Output DACs

## Shutdown-Mode Bits (PD\_0, PD\_1)

Use the shutdown-mode bits and control bits to shut down each DAC independently. The shutdown-mode bits determine the output state of the selected channels. The shutdown-control bits put the selected channels into shutdown mode. To select the shutdown mode for DACA–DACD, set PD\_0 and PD\_1 according to Table 8 (where “\_” is replaced with one of the selected channels (A–D)). The three possible states for unity-gain versions are 1) normal operation, 2) shutdown with

1k $\Omega$  output impedance, and 3) shutdown with 100k $\Omega$  output impedance. The three possible states for force-sense versions are 1) normal operation, 2) shutdown with 1k $\Omega$  output impedance, and 3) shutdown with the output in a high-impedance state. Table 9 shows the commands for writing to the shutdown-mode bits. Table 10 shows an example of writing the shutdown-control bits. This command shuts down DACA with 1k $\Omega$  to ground and shuts down DACB–DACD with 100k $\Omega$  to ground.

Always write the shutdown-mode-bits command first and then write the shutdown-control-bits command to properly shut down the selected channels. The shutdown-control-bits command can be written at any time after the shutdown-mode-bits command. It does not have to immediately follow the shutdown-mode-bits command.

## Settling-Time-Mode Bits (SPD\_)

The settling-time-mode bits select the settling time (FAST mode or SLOW mode) of the MAX5580–MAX5585. Set SPD\_ = 1 to select FAST mode or set SPD\_ = 0 to select SLOW mode, where “\_” is replaced by A, B, C, or D, depending on the selected channel (Table 11). FAST mode provides a 3 $\mu$ s maximum settling time, and SLOW mode provides a 6 $\mu$ s maximum settling time.

**Table 8. Shutdown-Mode Bits**

| PD_1 | PD_0 | DESCRIPTION   |
|------|------|---|
| 0    | 0    | Shutdown with 1k $\Omega$ termination to ground on DAC_ output.   |
| 0    | 1    | Shutdown with 100k $\Omega$ termination to ground on DAC_ output for unity-gain versions. Shutdown with high-impedance output for force-sense versions. |
| 1    | 0    | Ignored.  |
| 1    | 1    | DAC_ is powered up in its normal operating mode.  |

**Table 9. Shutdown-Mode Write Command**

| DATA | CONTROL BITS |   |   |   |   |   |   |   | DATA BITS |      |      |      |      |      |      |      |
|------|--------------|---|---|---|---|---|---|---|-----------|------|------|------|------|------|------|------|
| DIN  | 1            | 1 | 1 | 0 | 0 | 1 | 0 | X | PDD1      | PDD0 | PDC1 | PDC0 | PDB1 | PDB0 | PDA1 | PDA0 |

X = Don't care.

**Table 10. Shutdown-Mode-Bits Write Example**

| DATA | CONTROL BITS |   |   |   |   |   |   |   | DATA BITS |   |   |   |   |   |   |   |
|------|--------------|---|---|---|---|---|---|---|-----------|---|---|---|---|---|---|---|
| DIN  | 1            | 1 | 1 | 0 | 0 | 1 | 0 | X | 0         | 1 | 0 | 1 | 0 | 1 | 0 | 0 |

X = Don't care.

**Table 11. Settling-Time-Mode Write Command**

| DATA | CONTROL BITS |   |   |   |   |   |   |   | DATA BITS |   |   |   |      |      |      |      |
|------|--------------|---|---|---|---|---|---|---|-----------|---|---|---|------|------|------|------|
| DIN  | 1            | 1 | 1 | 0 | 1 | 1 | 0 | X | X         | X | X | X | SPDD | SPDC | SPDB | SPDA |

X = Don't care.

# Buffered, Fast-Settling, Quad, 12-/10-/8-Bit, Voltage-Output DACs

## Settling-Time-Mode Write Example:

To configure DACA and DACD into FAST mode and DACB and DACC into SLOW mode, use the command in Table 12.

To read back the settling-time-mode bits, use the command in Table 13.

### CPOL and CPHA Control Bits

The CPOL and CPHA control bits of the MAX5580-MAX5585 are defined the same as the CPOL and CPHA bits in the SPI standard. Set the DAC's CPOL and CPHA bits to CPOL = 0 and CPHA = 0 or CPOL = 1 and CPHA = 1 for MICROWIRE and SPI applications requiring the clocking of data in on the ris-

ing edge of SCLK. Set the DAC's CPOL and CPHA bits to CPOL = 0 and CPHA = 1 or CPOL = 1 and CPHA = 0 for DSP and SPI applications, requiring the clocking of data in on the falling edge of SCLK (refer to the *Programmer's Handbook* and see Table 14 for details). At power-up, if  $\overline{DSP} = DV_{DD}$ , the default value of CPHA is zero and if  $\overline{DSP} = DGND$ , the default value of CPHA is one. The default value of CPOL is zero at power-up.

To write to the CPOL and CPHA bits, use the command in Table 15.

To read back the device's CPOL and CPHA bits, use the command in Table 16.

**Table 12. Settling-Time-Mode Write Example**

| DATA | CONTROL BITS |   |   |   |   |   |   |   | DATA BITS |   |   |   |   |   |   |   |
|------|--------------|---|---|---|---|---|---|---|-----------|---|---|---|---|---|---|---|
| DIN  | 1            | 1 | 1 | 0 | 1 | 1 | 0 | X | X         | X | X | X | 1 | 0 | 0 | 1 |

X = Don't care.

**Table 13. Settling-Time-Mode Read Command**

| DATA               | CONTROL BITS |   |   |   |   |   |   |   | DATA BITS |   |   |   |      |      |      |      |
|--------------------|--------------|---|---|---|---|---|---|---|-----------|---|---|---|------|------|------|------|
| DIN                | 1            | 1 | 1 | 0 | 1 | 1 | 1 | 1 | X         | X | X | X | X    | X    | X    | X    |
| DOU <sub>TRB</sub> | X            | X | X | X | X | X | X | X | X         | X | X | X | SPDD | SPDC | SPDB | SPDA |

X = Don't care.

**Table 14. CPOL and CPHA Bits**

| CPOL | CPHA | DESCRIPTION   |
|------|------|---|
| 0    | 0    | Default values at power-up when $\overline{DSP}$ is connected to $DV_{DD}$ . Data is clocked in on the rising edge of SCLK. |
| 0    | 1    | Default values at power-up when $\overline{DSP}$ is connected to $DGND$ . Data is clocked in on the falling edge of SCLK.   |
| 1    | 0    | Data is clocked in on the falling edge of SCLK.   |
| 1    | 1    | Data is clocked in on the rising edge of SCLK.  |

**Table 15. CPOL and CPHA Write Command**

| DATA | CONTROL BITS |   |   |   |   |   |   |   | DATA BITS |   |   |   |   |   |      |      |
|------|--------------|---|---|---|---|---|---|---|-----------|---|---|---|---|---|------|------|
| DIN  | 1            | 1 | 1 | 1 | 0 | 0 | 0 | 0 | X         | X | X | X | X | X | CPOL | CPHA |

X = Don't care.

**Table 16. CPOL and CPHA Read Command**

| DATA               | CONTROL BITS |   |   |   |   |   |   |   | DATA BITS |   |   |   |   |   |      |      |
|--------------------|--------------|---|---|---|---|---|---|---|-----------|---|---|---|---|---|------|------|
| DIN                | 1            | 1 | 1 | 1 | 0 | 0 | 0 | 1 | X         | X | X | X | X | X | X    | X    |
| DOU <sub>TRB</sub> | X            | X | X | X | X | X | X | X | X         | X | X | X | X | X | CPOL | CPHA |

X = Don't care.

# Buffered, Fast-Settling, Quad, 12-/10-/8-Bit, Voltage-Output DACs

### UPIO Bits (UPSL1, UPSL2, UP0-UP3)

The MAX5580-MAX5585 provide two user-programmable input/output (UPIO) ports: UPIO1 and UPIO2. These ports have 15 possible configurations, as shown in Table 21. UPIO1 and UPIO2 can be programmed independently or simultaneously by writing to the UPSL1, UPSL2, and UP0-UP3 bits (Table 17).

Table 18 shows how UPIO1 and UPIO2 are selected for configuration. The UP0-UP3 bits select the desired functions for UPIO1 and/or UPIO2 (Table 21).

### UPIO Programming Example:

To set only UPIO1 as LDAC and leave UPIO2 unchanged, use the command in Table 19.

The UPIO selection and configuration bits can be read back from the MAX5580-MAX5585 when UPIO1 or UPIO2 is configured as a DOUTRB output. Table 20 shows the read-back data format for the UPIO bits. Writing the command in Table 20 initiates a read operation of the UPIO bits. The data is clocked out starting on the 9th clock cycle of the sequence. Bits UP3-2 through UP0-2 provide the UP3-UP0 configuration bits for UPIO2 (Table 21), and bits UP3-1 through UP0-1 provide the UP3-UP0 configuration bits for UPIO1.

**Table 17. UPIO Write Command**

| DATA | CONTROL BITS |   |   |   |   |   |   |   | DATA BITS |       |     |     |     |     |   |   |
|------|--------------|---|---|---|---|---|---|---|-----------|-------|-----|-----|-----|-----|---|---|
| DIN  | 1            | 1 | 1 | 0 | 1 | 0 | 0 | X | UPSL2     | UPSL1 | UP3 | UP2 | UP1 | UP0 | X | X |

X = Don't care.

**Table 18. UPIO Selection Bits (UPSL1 and UPSL2)**

| UPSL2 | UPSL1 | UPIO PORT SELECTED            |
|-------|-------|-------------------------------|
| 0     | 0     | None selected                 |
| 0     | 1     | UPIO1 selected                |
| 1     | 0     | UPIO2 selected                |
| 1     | 1     | Both UPIO1 and UPIO2 selected |

**Table 19. UPIO Programming Example**

| DATA | CONTROL BITS |   |   |   |   |   |   |   | DATA BITS |   |   |   |   |   |   |   |
|------|--------------|---|---|---|---|---|---|---|-----------|---|---|---|---|---|---|---|
| DIN  | 1            | 1 | 1 | 0 | 1 | 0 | 0 | X | 0         | 1 | 0 | 0 | 0 | 0 | X | X |

X = Don't care.

**Table 20. UPIO Read Command**

| DATA   | CONTROL BITS |   |   |   |   |   |   |   | DATA BITS |       |       |       |       |       |       |       |
|--------|--------------|---|---|---|---|---|---|---|-----------|-------|-------|-------|-------|-------|-------|-------|
| DIN    | 1            | 1 | 1 | 0 | 1 | 0 | 1 | X | X         | X     | X     | X     | X     | X     | X     | X     |
| DOUTRB | X            | X | X | X | X | X | X | X | UP3-2     | UP2-2 | UP1-2 | UP0-2 | UP3-1 | UP2-1 | UP1-1 | UP0-1 |

X = Don't care.

# Buffered, Fast-Settling, Quad, 12-/10-/8-Bit, Voltage-Output DACs

## UPIO Configuration

Table 21 lists the possible configurations for UPIO1 and UPIO2. UPIO1 and UPIO2 use the selected function when configured by the UP3–UP0 configuration bits.

### LDAC

$\overline{\text{LDAC}}$  controls the loading of the DAC registers. When  $\overline{\text{LDAC}}$  is high, the DAC registers are latched, and any change in the input registers does not affect the contents of the DAC registers or the DAC outputs. When  $\overline{\text{LDAC}}$  is low, the DAC registers are transparent, and the values stored in the input registers are fed directly to the DAC registers, and the DAC outputs are updated.

Drive  $\overline{\text{LDAC}}$  low to asynchronously load the DAC registers from their corresponding input registers (DACs that are in shutdown remain shut down). The  $\overline{\text{LDAC}}$  input does not require any activity on  $\overline{\text{CS}}$ , SCLK, or DIN to take effect. If  $\overline{\text{LDAC}}$  is brought low coincident with a rising edge of  $\overline{\text{CS}}$  (which executes a serial command modifying the value of either DAC input register), then  $\overline{\text{LDAC}}$  must remain asserted for at least 120ns following the  $\overline{\text{CS}}$  rising edge. This requirement applies only for serial commands that modify the value of the DAC input registers. See Figures 5 and 6 for timing details.

**Table 21. UPIO Configuration Register Bits (UP3–UP0)**

| UPIO CONFIGURATION BITS |     |     |     | FUNCTION                     | DESCRIPTION  |
|-------------------------|-----|-----|-----|------------------------------|--|
| UP3                     | UP2 | UP1 | UP0 |                              |  |
| 0                       | 0   | 0   | 0   | $\overline{\text{LDAC}}$     | Active-Low Load DAC Input. Drive low to asynchronously load all DAC registers with data from input registers.  |
| 0                       | 0   | 0   | 1   | $\overline{\text{SET}}$      | Active-Low Input. Drive low to set all input and DAC registers to full scale.  |
| 0                       | 0   | 1   | 0   | $\overline{\text{MID}}$      | Active-Low Input. Drive low to set all input and DAC registers to midscale.  |
| 0                       | 0   | 1   | 1   | $\overline{\text{CLR}}$      | Active-Low Input. Drive low to set all input and DAC registers to zero scale.  |
| 0                       | 1   | 0   | 0   | $\overline{\text{PDL}}$      | Active-Low Power-Down Lockout Input. Drive low to disable software shutdown.   |
| 0                       | 1   | 0   | 1   | Reserved                     | This mode is reserved. Do not use.   |
| 0                       | 1   | 1   | 0   | $\overline{\text{SHDN1K}}$   | Active-Low 1k $\Omega$ Shutdown Input. Overrides PD_1 and PD_0 settings. For the MAX5580/MAX5582/MAX5584, drive $\overline{\text{SHDN1K}}$ low to pull OUTA–OUTD to AGND with 1k $\Omega$ . For the MAX5581/MAX5583/MAX5585, drive $\overline{\text{SHDN1K}}$ low to leave OUTA–OUTD high impedance. |
| 0                       | 1   | 1   | 1   | $\overline{\text{SHDN100K}}$ | Active-Low 100k $\Omega$ Shutdown Input. Overrides PD_1 and PD_0 settings. For the MAX5580/MAX5582/MAX5584, drive $\overline{\text{SHDN100K}}$ low to pull OUTA–OUTD to AGND with 100k $\Omega$ . For the MAX5581/MAX5583/MAX5585, drive low to leave OUTA–OUTD high impedance.                      |
| 1                       | 0   | 0   | 0   | DOU $\overline{\text{TRB}}$  | Data Read-Back Output  |
| 1                       | 0   | 0   | 1   | DOU $\overline{\text{TDC0}}$ | Mode 0 Daisy-Chain Data Output. Data is clocked out on the falling edge of SCLK.   |
| 1                       | 0   | 1   | 0   | DOU $\overline{\text{TDC1}}$ | Mode 1 Daisy-Chain Data Output. Data is clocked out on the rising edge of SCLK.  |
| 1                       | 0   | 1   | 1   | GPI                          | General-Purpose Logic Input  |
| 1                       | 1   | 0   | 0   | G $\overline{\text{POL}}$    | General-Purpose Logic-Low Output   |
| 1                       | 1   | 0   | 1   | G $\overline{\text{POH}}$    | General-Purpose Logic-High Output  |
| 1                       | 1   | 1   | 0   | TOGG                         | Toggle Input. Toggles DAC outputs between data in input registers and data in DAC registers. Drive low to set all DAC outputs to values stored in input registers. Drive high to set all DAC outputs to values stored in DAC registers.  |
| 1                       | 1   | 1   | 1   | $\overline{\text{FAST}}$     | Fast/Slow Settling-Time-Mode Input. Drive low to select FAST (3 $\mu$ s) mode or drive high to select SLOW (6 $\mu$ s) settling mode. Overrides the SPDA–SPDD settings.  |

# Buffered, Fast-Settling, Quad, 12-/10-/8-Bit, Voltage-Output DACs

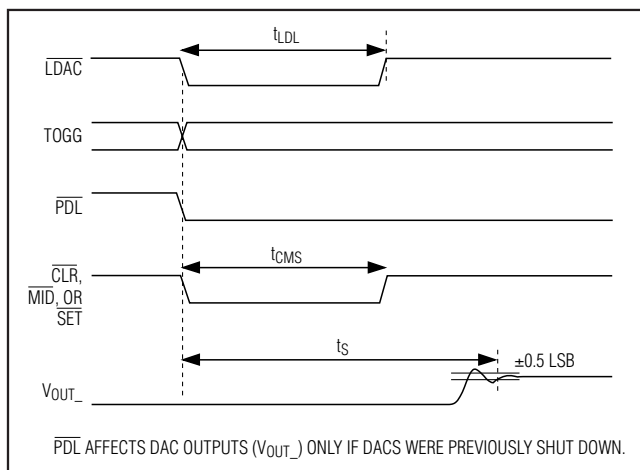

Figure 5. Asynchronous Signal Timing

## SET, MID, CLR

The  $\overline{\text{SET}}$ ,  $\overline{\text{MID}}$ , and  $\overline{\text{CLR}}$  signals force the DAC outputs to full scale, midscale, or zero scale (Figure 5). These signals cannot be active at the same time.

The active-low  $\overline{\text{SET}}$  input forces the DAC outputs to full scale when  $\overline{\text{SET}}$  is low. When  $\overline{\text{SET}}$  is high, the DAC outputs follow the data in the DAC registers.

The active-low  $\overline{\text{MID}}$  input forces the DAC outputs to midscale when  $\overline{\text{MID}}$  is low. When  $\overline{\text{MID}}$  is high, the DAC outputs follow the data in the DAC registers.

The active-low  $\overline{\text{CLR}}$  input forces the DAC outputs to zero scale when  $\overline{\text{CLR}}$  is low. When  $\overline{\text{CLR}}$  is high, the DAC outputs follow the data in the DAC registers.

If  $\overline{\text{CLR}}$ ,  $\overline{\text{MID}}$ , or  $\overline{\text{SET}}$  signals go low during a write command, reload the data to ensure accurate results.

## Power-Down Lockout (PDL)

The  $\overline{\text{PDL}}$  active-low, software-shutdown lockout input overrides (not overwrites) the PD\_0 and PD\_1 shutdown-mode bits.  $\overline{\text{PDL}}$  cannot be active at the same time as  $\overline{\text{SHDN1K}}$  or  $\overline{\text{SHDN100K}}$  (see the *Shutdown Mode (SHDN1K, SHDN100K)* section).

If the PD\_0 and PD\_1 bits command the DAC to shut down prior to  $\overline{\text{PDL}}$  going low, the DAC returns to shutdown mode immediately after  $\overline{\text{PDL}}$  goes high, unless the PD\_0 and PD\_1 bits were modified through the serial interface in the meantime.

## Shutdown Mode (SHDN1K, SHDN100K)

The  $\overline{\text{SHDN1K}}$  and  $\overline{\text{SHDN100K}}$  are active-low signals that override (not overwrite) the PD\_1 and PD\_0 bit settings. For the MAX5580/MAX5582/MAX5584, drive

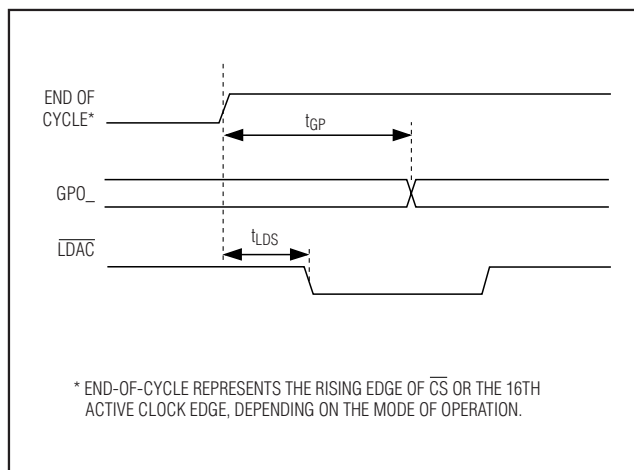

Figure 6. GPO\_ and LDAC Signal Timing

$\overline{\text{SHDN1K}}$  low to select shutdown mode with OUTA-OUTD internally terminated with 1k $\Omega$  to ground, or drive  $\overline{\text{SHDN100K}}$  low to select shutdown with an internal 100k $\Omega$  termination. For the MAX5581/MAX5583/MAX5585, drive  $\overline{\text{SHDN1K}}$  low for shutdown with 1k $\Omega$  output termination, or drive  $\overline{\text{SHDN100K}}$  low for shutdown with high-impedance outputs.

## Data Output (DOUTRB, DOUTDC0, DOUTDC1)

UPIO1 and UPIO2 can be configured as serial data outputs, DOUTRB (data out for read back), DOUTDC0 (data out for daisy-chaining, mode 0), and DOUTDC1 (data out for daisy-chaining, mode 1). The differences between DOUTRB and DOUTDC0 (or DOUTDC1) are as follows:

- The source of read-back data on DOUTRB is the DOUT register. Daisy-chain DOUTDC\_ data comes directly from the shift register.
- Read-back data on DOUTRB is only present after a DAC read command. Daisy-chain data is present on DOUTDC\_ for any DAC write after the first 16 bits are written.
- The DOUTRB idle state ( $\overline{\text{CS}}$  = high) for read back is high impedance. Daisy-chain DOUTDC\_ idles high when inactive to avoid floating the data input in the next device in the daisy-chain.

See Figures 1 and 2 for timing details.

# Buffered, Fast-Settling, Quad, 12-/10-/8-Bit, Voltage-Output DACs

### GPI, GPOL, GPOH

UPIO1 and UPIO2 can each be configured as a general-purpose input (GPI), a general-purpose output low (GPOL), or a general-purpose output high (GPOH).

The GPI can serve to detect interrupts from  $\mu$ Ps or micro-controllers. The GPI has three functions:

- 1) Sample the signal at GPI at the time of the read (RTP1 and RTP2).
- 2) Detect whether a falling edge has occurred since the last read or reset (LF1 and LF2).
- 3) Detect whether a rising edge has occurred since the last read or reset (LR1 and LR2).

RTP1, LF1, and LR1 represent the data read from UPIO1; RTP2, LF2, and LR2 represent the data read from UPIO2.

To issue a read command for the UPIO configured as GPI, use the command in Table 22.

Once the command is issued, RTP1 and RTP2 provide the real-time status (0 or 1) of the inputs at UPIO1 or UPIO2, respectively, at the time of the read. If LF2 or LF1 is one, then a falling edge has occurred on the respective UPIO1 or UPIO2 input since the last read or reset. If LR2 or LR1 is one, then a rising edge has occurred since the last read or reset.

**Table 22. GPI Read Command**

| DATA               | CONTROL BITS |   |   |   |   |   |   |   | DATA BITS |   |      |     |     |      |     |     |
|--------------------|--------------|---|---|---|---|---|---|---|-----------|---|------|-----|-----|------|-----|-----|
| DIN                | 1            | 1 | 1 | 1 | 0 | 0 | 1 | X | X         | X | X    | X   | X   | X    | X   | X   |
| DOU <sub>TRB</sub> | X            | X | X | X | X | X | X | X | X         | X | RTP2 | LF2 | LR2 | RTP1 | LF1 | LR1 |

X = Don't care.

**Table 23. Unipolar Code Table (Gain = +1)**

| DAC CONTENTS |      |      | ANALOG OUTPUT  |
|--------------|------|------|--|
| MSB          | LSB  |      |  |
| 1111         | 1111 | 1111 | +V <sub>REF</sub> (4095 / 4096)                        |
| 1000         | 0000 | 0001 | +V <sub>REF</sub> (2049 / 4096)                        |
| 1000         | 0000 | 0000 | +V <sub>REF</sub> (2048 / 4096) = V <sub>REF</sub> / 2 |
| 0111         | 1111 | 1111 | +V <sub>REF</sub> (2047 / 4096)                        |
| 0000         | 0000 | 0001 | +V <sub>REF</sub> (1 / 4096)                           |
| 0000         | 0000 | 0000 | 0  |

GPOL outputs a constant low, and GPOH outputs a constant high. See Figure 6.

### TOGG

Use the TOGG input to toggle the DAC outputs between the values in the input registers and DAC registers. A delay of greater than 100ns from the end of the previous write command is required before the TOGG signal can be correctly switched between the new value and the previously stored value. When TOGG = 0, the output follows the information in the input registers. When TOGG = 1, the output follows the information in the DAC register (Figure 5).

### FAST

The MAX5580-MAX5585 have two settling-time-mode options: FAST (3 $\mu$ s max) and SLOW (6 $\mu$ s max). To select the FAST mode, drive  $\overline{\text{FAST}}$  low, and to select SLOW mode, drive  $\overline{\text{FAST}}$  high. This overrides (not overwrites) the SPDA-SPDD bit settings.

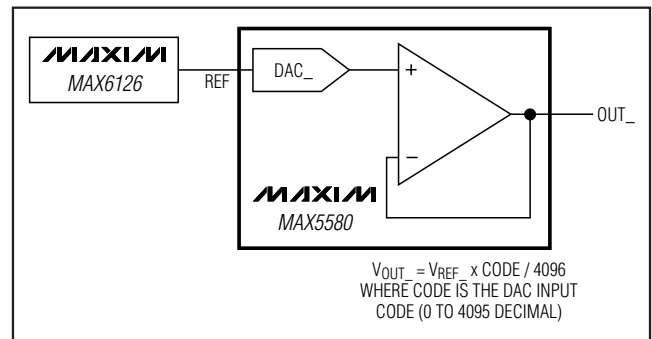

Figure 7. Unipolar Output Circuit

# Buffered, Fast-Settling, Quad, 12-/10-/8-Bit, Voltage-Output DACs

## Applications Information

### Unipolar Output

Figure 7 shows the unity-gain MAX5580 in a unipolar output configuration. Table 23 lists the unipolar output codes.

### Bipolar Output

The MAX5580 outputs can be configured for bipolar operation, as shown in Figure 8. The output voltage is given by the following equation:

$$V_{OUT\_} = V_{REF} \times (\text{CODE} - 2048) / 2048$$

where CODE represents the numeric value of the DAC's binary input code (0 to 4095 decimal). Table 24 shows digital codes and the corresponding output voltage for the circuit in Figure 8.

### Configurable Output Gain

The MAX5581/MAX5583/MAX5585 have force-sense outputs, which provide a direct connection to the inverting terminal of the output op amp, yielding the most flexibility. The force-sense output has the advantage that specific gains can be set externally for a given application. The gain error for the MAX5581/MAX5583/MAX5585 is specified in a unity-gain configuration (op-amp output and inverting terminals connected), and additional gain error results from external resistor tolerances. The force-sense DACs allow many useful circuits to be created with only a few simple external components.

An example of a custom, fixed gain using the MAX5581's force-sense output is shown in Figure 9. In this example, the external reference is set to 1.25V, and the gain is set to +1.1V/V with external discrete resistors to provide an approximate 0 to 1.375V DAC output voltage range.

$$V_{OUT} = [(0.5 \times V_{REF\_} \times \text{CODE}) / 4096] \times [1 + (R2 / R1)]$$

where CODE represents the numeric value of the DAC's binary input code (0 to 4095 decimal).

In this example, R2 = 12kΩ and R1 = 10kΩ to set the gain is 1.1V/V:

$$V_{OUT} = [(0.5 \times 1.25V \times \text{CODE}) / 4096] \times 2.2$$

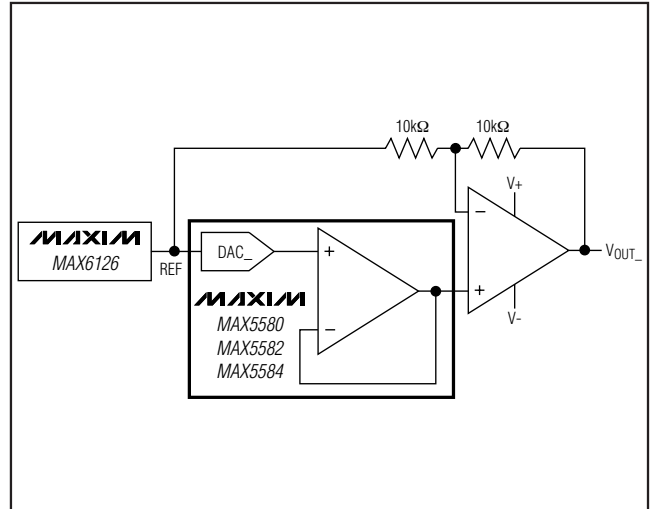

Figure 8. Bipolar Output Circuit

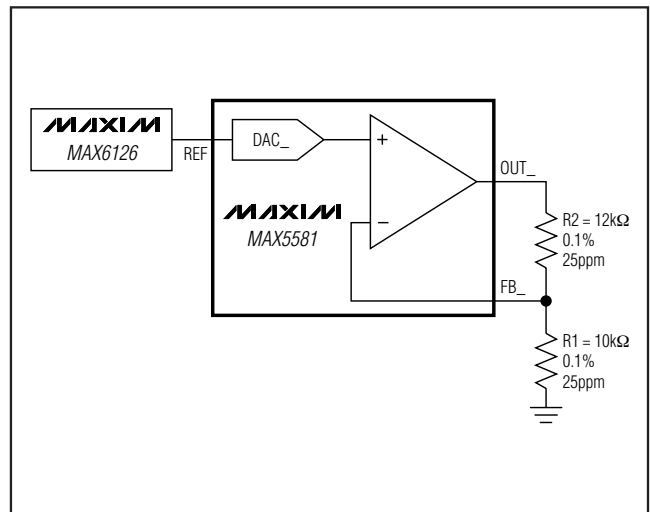

Figure 9. Configurable Output Gain

Table 24. Bipolar Code Table (Gain = +1)

| DAC CONTENTS |      |      | ANALOG OUTPUT               |
|--------------|------|------|-----------------------------|
| MSB          | LSB  |      |                             |
| 1111         | 1111 | 1111 | +VREF (2047 / 2048)         |
| 1000         | 0000 | 0001 | +VREF (1 / 2048)            |
| 1000         | 0000 | 0000 | 0                           |
| 0111         | 1111 | 1111 | -VREF (1 / 2048)            |
| 0000         | 0000 | 0001 | -VREF (2047 / 2048)         |
| 0000         | 0000 | 0000 | -VREF (2048 / 2048) = -VREF |

# Buffered, Fast-Settling, Quad, 12-/10-/8-Bit, Voltage-Output DACs

## Power-Supply and Layout Considerations

Bypass the analog and digital power supplies by using a 10µF capacitor in parallel with a 0.1µF capacitor to AGND and DGND (Figure 10). Minimize lead lengths to reduce lead inductance. Use shielding and/or ferrite beads to further increase isolation.

Digital and AC transient signals coupling to AGND can create noise at the output. Connect AGND to the highest quality ground available. Use proper grounding techniques, such as a multilayer board with a low-

inductance ground plane. Wire-wrapped boards and sockets are not recommended. For optimum system performance, use PC boards with separate analog and digital ground planes. Connect the two ground planes together at the low-impedance power-supply source.

Using separate power supplies for AV<sub>DD</sub> and DV<sub>DD</sub> improves noise immunity. Connect AGND and DGND at the low-impedance power-supply sources (Figure 11).

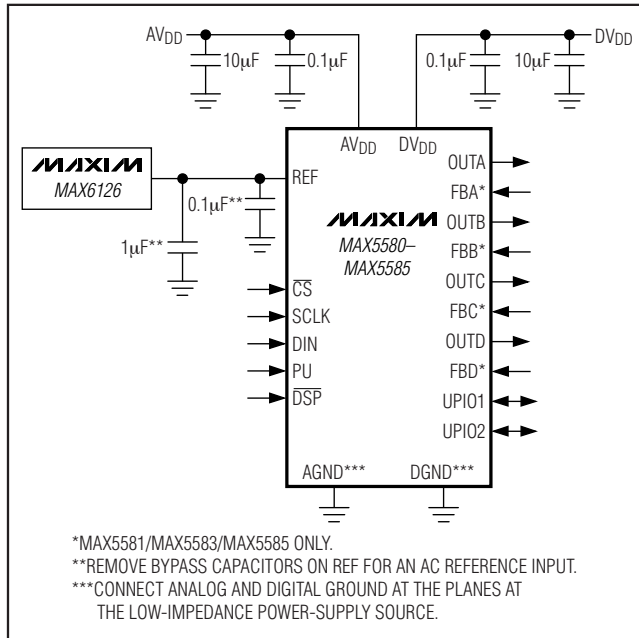

Figure 10. Bypassing Power Supplies AV<sub>DD</sub>, DV<sub>DD</sub>, and REF

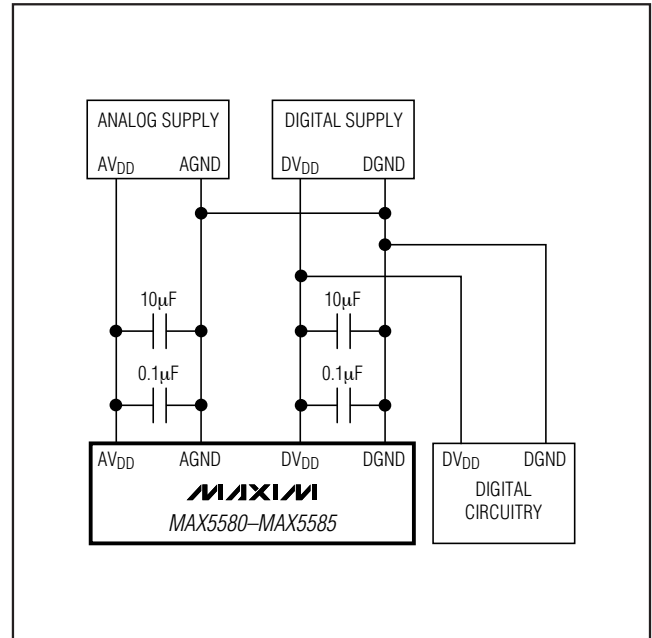
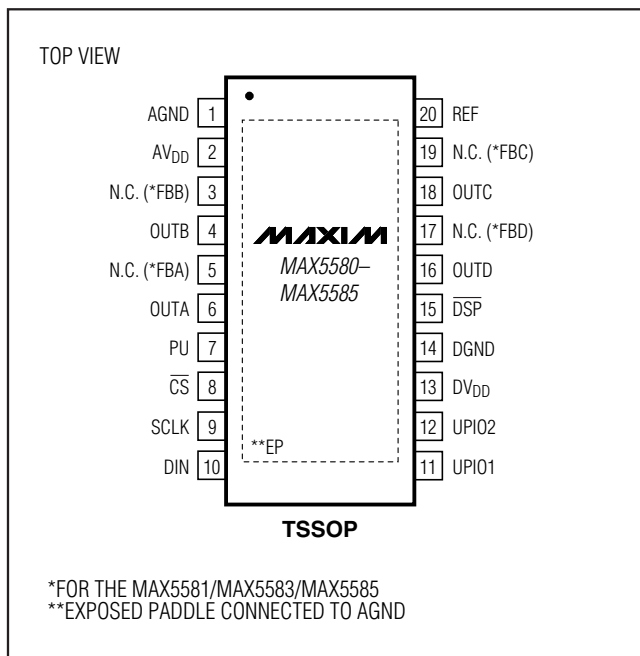

Figure 11. Separate Analog and Digital Power Supplies

# Buffered, Fast-Settling, Quad, 12-/10-/8-Bit, Voltage-Output DACs

## Pin Configuration



## Chip Information

TRANSISTOR COUNT: 24,393

PROCESS: BiCMOS

## Package Information

For the latest package outline information and land patterns, go to [www.maxim-ic.com/packages](http://www.maxim-ic.com/packages).

| PACKAGE TYPE | PACKAGE CODE | DOCUMENT NO.            |
|--------------|--------------|-------------------------|
| 22 TSSOP-EP  | U20E-1       | <a href="#">21-0108</a> |

**MAX5580-MAX5585**

# **Buffered, Fast-Settling, Quad, 12-/10-/8-Bit, Voltage-Output DACs**

## **Revision History**

| <b>REVISION NUMBER</b> | <b>REVISION DATE</b> | <b>DESCRIPTION</b>                       | <b>PAGES CHANGED</b> |
|------------------------|----------------------|--|----------------------|
| 3                      | 7/07                 | Updated EC table specs                   | 6-9                  |
| 4                      | 7/08                 | Removed TQFN information from data sheet | 1, 2, 14, 33-36      |

*Maxim cannot assume responsibility for use of any circuitry other than circuitry entirely embodied in a Maxim product. No circuit patent licenses are implied. Maxim reserves the right to change the circuitry and specifications without notice at any time.*

**34** \_\_\_\_\_ **Maxim Integrated Products, 120 San Gabriel Drive, Sunnyvale, CA 94086 408-737-7600**

## Looking for pricing, stock, or lifecycle information?

Click below to explore more details on WIN SOURCE:

 [View MAX5582EUP+](#) on WIN SOURCE

 [Maxim Integrated](#) Information

## Optimize Your Supply Chain with WIN SOURCE Solutions

-  Global Sourcing Solution
-  Obsolete Management
-  Cost Control Management
-  Shortage Management
-  Alternative Solution
-  Excess Inventory Management