





# MAX5432 Evaluation Kit

## General Description

The MAX5432 evaluation kit (EV kit) is an assembled and tested printed-circuit board (PCB) that evaluates the MAX5432 IC. The MAX5432 is a 32-tap, 50k $\Omega$ , non-volatile, linear digital potentiometer communicating over I<sup>2</sup>C. The MAX5432 features an internal nonvolatile EEPROM used to store the potentiometer's wiper position for initialization during power-up. The EEPROM is programmed through the I<sup>2</sup>C-compatible serial interface, communicating at data rates up to 400kbps. The I<sup>2</sup>C signals can be transmitted through an on-board USB interface circuit using a computer or a user-supplied I<sup>2</sup>C bus along with the PCB interfacing pads.

The EV kit also features Windows 2000/XP/Vista<sup>®</sup>-compatible software that provides a professional user interface for exercising the MAX5432's features. The program is menu driven and offers a graphical user interface (GUI) complete with buttons, track bars, and pulldown menus.

The EV kit is powered from a 3.3V source generated from the EV kit's USB interface circuit, or an external 2.7V to 5.25V DC power supply. The MAX5432 IC is available in two versions, the MAX5432LETA and the MAX5432META; each version has two selectable I<sup>2</sup>C addresses. The MAX5432 EV kit is shipped with a MAX5432LETA IC installed.

The EV kit can also evaluate the MAX5433 (100k $\Omega$ ) after IC replacement (U1). The MAX5433 is also available in two versions; each version has four unique I<sup>2</sup>C addresses.

Windows Vista is a registered trademark of Microsoft Corp.

DESIGNATION	QTY	DESCRIPTION
C1, C3–C10, C17, C26	11	0.1 $\mu$ F $\pm$ 10%, 16V X7R ceramic capacitors (0603) Murata GRM188R71C104K TDK C1608X7R1C104K
C2, C13, C15	3	10 $\mu$ F $\pm$ 20%, 6.3V X5R ceramic capacitors (0805) Murata GRM21BR60J106M TDK C2012X5R0J106M
C11, C12	2	10pF $\pm$ 5%, 50V C0G ceramic capacitors (0603) Murata GRM1885C1H100J TDK C1608C0G1H100J
C14, C16, C21–C25	7	1 $\mu$ F $\pm$ 10%, 10V X5R ceramic capacitors (0603) Murata GRM188R61A105K TDK C1608X5R1A105K

## Features

- ◆ Power-On Recall of Wiper Position from Nonvolatile Memory
- ◆ 2.7V to 5.25V Single-Supply Operation
- ◆ Configurable Device Address
- ◆ On-Board USB Interface Circuit for I<sup>2</sup>C-Compatible Signals
- ◆ USB-PC Connection and Powered (Cable Included)
- ◆ PCB Pads for User-Supplied I<sup>2</sup>C-Compatible Signals
- ◆ PCB Pads for Potentiometer Signals L, W, H
- ◆ Proven USB-Compatible PCB Layout
- ◆ Evaluates the MAX5432LETA, MAX5432META, MAX5433LETA, and MAX5433META in a 3mm x 3mm 8-pin TDFN package
- ◆ Windows 2000/XP/Vista (32-Bit)-Compatible Software
- ◆ Fully Assembled and Tested

## Ordering Information

PART	TYPE
MAX5432EVKIT+	EV Kit

+Denotes lead-free and RoHS-compliant.

## Component List

DESIGNATION	QTY	DESCRIPTION
C18, C19	2	22pF $\pm$ 5%, 50V C0G ceramic capacitors (0603) Murata GRM1885C1H220J TDK C1608C0G1H220J
C20	1	3300pF $\pm$ 10%, 50V X7R ceramic capacitor (0603) Murata GRM188R71H332K TDK C1608X7R1H332K
D1	1	Green LED (0603) Panasonic LNJ314G8TRA
FB1	0	Not installed, ferrite-bead inductor (0603)
JU1	1	3-pin header
JU2–JU6	5	2-pin headers
P1	1	USB series type-B right-angle male receptacle



# MAX5432 Evaluation Kit

## Component List (continued)

DESIGNATION	QTY	DESCRIPTION
R1	1	0 $\Omega$ $\pm$ 5% resistor (0603)
R2	1	220 $\Omega$ $\pm$ 5% resistor (0603)
R3	1	10k $\Omega$ $\pm$ 5% resistor (0603)
R4	1	2.2k $\Omega$ $\pm$ 5% resistor (0603)
R5	1	1.5k $\Omega$ $\pm$ 5% resistor (0603)
R6, R7	2	27 $\Omega$ $\pm$ 5% resistors (0603)
R8–R11	4	2k $\Omega$ $\pm$ 5% resistors (0603)
R12	1	100k $\Omega$ $\pm$ 5% resistor (0603)
U1	1	Nonvolatile linear taper digital potentiometer (8-pin TDFN-EP*) Maxim MAX5432LETA+
U2	1	32-bit microcontroller (68-pin QFN-EP*, 10mm x 10mm) Maxim MAXQ2000-RAX+
U3	1	93C46 type 3-wire EEPROM 16-bit architecture (8-pin SO)
U4	1	UART-to-USB converter (32-pin TQFP, 7mm x 7mm)
U5	1	3.3V regulator (5-pin SC70) Maxim MAX8511EXK33+
U6	1	2.5V regulator (5-pin SC70) Maxim MAX8511EXK25+
U7, U8	2	Low-voltage level translators (10-pin $\mu$ MAX <sup>®</sup> ) Maxim MAX1840EUB+

$\mu$ MAX is a registered trademark of Maxim Integrated Products, Inc.

DESIGNATION	QTY	DESCRIPTION
Y1	1	16MHz crystal
Y2	1	6MHz crystal
—	6	Shunts
—	1	USB high-speed A-to-B cable, 6ft
—	1	PCB: MAX5432 Evaluation Kit+

\*EP = Exposed pad.

## Component Suppliers

SUPPLIER	PHONE	WEBSITE
Murata Mfg. Co., Ltd.	770-436-1300	www.murata.com
Panasonic Corp.	800-344-2112	www.panasonic.com
TDK Corp.	847-803-6100	www.component.tdk.com

**Note:** Indicate that you are using the MAX5432 or MAX5433 when contacting these component suppliers.

## MAX5432 EV Kit Files

FILE	DESCRIPTION
INSTALL.EXE	Installs the EV kit files on the computer
MAX5432.EXE	Application program
FTD2XX.INF	USB driver file
UNINST.INI	Uninstalls the EV kit software
USB_Driver_Help.PDF	USB driver installation help file

**Note:** The MAX5432 EV kit software can be downloaded from [www.maxim-ic.com/evkitsoftware](http://www.maxim-ic.com/evkitsoftware).

## Quick Start

### Required Equipment

Before beginning, the following equipment is needed:

- MAX5432 EV kit (USB cable included)
- A user-supplied Windows 2000/XP/Vista-compatible PC with a spare USB port
- Ohmmeter

**Note:** In the following sections, software-related items are identified by bolding. Text in **bold** refers to items directly from the EV kit software. Text in **bold and underlined** refers to items from the Windows operating system.

### Procedure

The MAX5432 EV kit is fully assembled and tested. Follow the steps below to verify board operation:

- 1) Visit [www.maxim-ic.com/evkitsoftware](http://www.maxim-ic.com/evkitsoftware) to download the latest version of the EV kit software, 5432Rxx.ZIP.

Save the EV kit software to a temporary folder and uncompress the ZIP file.

- 2) Install the EV kit software on the computer by running the INSTALL.EXE program inside the temporary folder. The program files are copied and icons are created in the Windows **Start | Programs** menu.
- 3) Verify that a shunt is installed on pins 1-2 of jumper JU1. This configures the MAX5432 IC's VDD to operate from the 3.3V generated by the USB interface circuit.
- 4) Verify that a shunt is installed on jumpers JU2 and JU3. This configures the I<sup>2</sup>C input pins to receive signals from the USB interface circuit.
- 5) Verify that a shunt is installed on jumper JU4. This configures the MAX5432LETA I<sup>2</sup>C address to 0x50.
- 6) Verify that no shunts are installed on jumpers JU5 and JU6, the L PCB pad is not connected to GND, and the H PCB pad is not connected to the W PCB pad.

# MAX5432 Evaluation Kit

Evaluates: MAX5432/MAX5433

- 7) Connect the ohmmeter across the W and L PCB pads.
- 8) Connect the included USB cable from the PC to the MAX5432 EV kit. A **Building Driver Database** window pops up in addition to a **New Hardware Found** message when installing the USB driver for the first time. If a window similar to the one described above does not appear after 30s, remove the USB cable from the board and reconnect it. Administrator privileges are required to install the USB device driver on Windows 2000/XP/Vista.
- 9) Follow the directions of the **Add New Hardware Wizard** to install the USB device driver. Choose the **Search for the best driver for your device** option. Specify the location of the device driver to be **C:\Program Files\MAX5432** (default installation directory) using the **Browse** button. During device driver installation, Windows may show a warning message indicating that the device driver Maxim uses does not contain a digital signature. This is not an error condition and it is safe to proceed with installation. Refer to the USB\_Driver\_Help.PDF document for additional information.
- 10) Start the MAX5432 EV kit software by opening its icon in the **Start | Programs** menu.
- 11) Observe as the program automatically detects the address of the MAX5432 and starts the main program. After successful connection, the EV kit soft-

ware main window appears in the upper-left corner of the window.

- 12) The MAX5432 EV kit is ready for additional testing.

See the *Detailed Description of Software* section for more information on the software features.

## **Detailed Description of Software**

In the following sections, text in **bold** refers to items directly from the EV kit software.

### **Graphical User Interface (GUI)**

The MAX5432 EV kit software GUI (Figure 1) is a Windows program that provides a convenient means to control the MAX5432. Use the mouse or press the **TAB** key to navigate through the GUI controls. The correct I<sup>2</sup>C write operation is generated to update the MAX5432 internal memory registers when any of these controls are executed.

The software divides EV kit functions into logical blocks. The **Interface** group box indicates the EV kit's **Status**, **Device Address**, **I<sup>2</sup>C Bus Speed**, the last write operation **Command Sent**, and **Data Sent** indicators. This data is used to confirm proper device operation. The **Potentiometer Control** group box changes the wiper position, stores the wiper position from the volatile memory to the nonvolatile memory, and recalls the wiper position from the nonvolatile memory to the

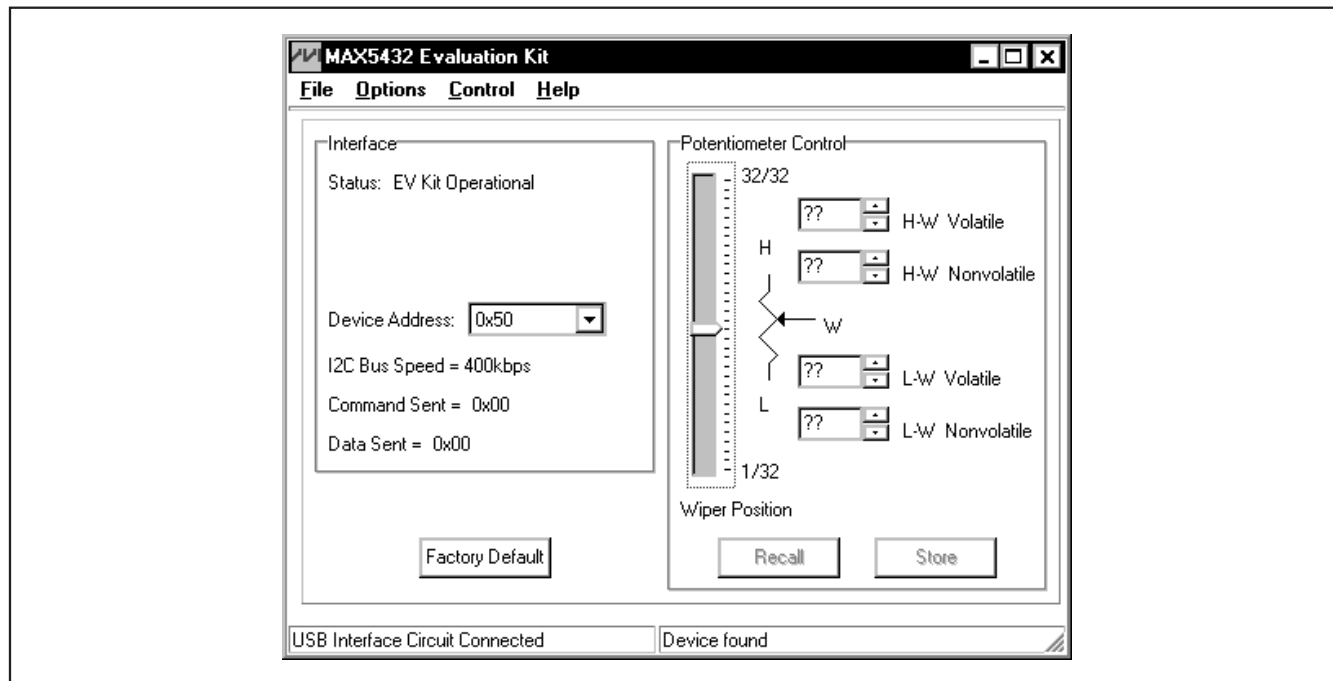

Figure 1. MAX5432 Evaluation Kit Software Main Window

# MAX5432 Evaluation Kit

volatile memory. The bottom-left status bar of the main window provides the USB interface circuit communication status. The bottom-right status bar indicates the presence or absence of the MAX5432 IC. The **Factory Default** button programs the volatile and nonvolatile memory of the potentiometer to midscale position.

## Software Startup

Upon starting the program, the MAX5432 EV kit software automatically searches for the USB interface-circuit connection, and then for the device address. The MAX5432 EV kit enters the normal operating mode when the USB connection is detected and has found the device address. The nonvolatile memory wiper position is then transferred to the volatile memory. Since the MAX5432 does not have read capability, all the spin boxes are set to question marks (??) and the track bar is set to midscale. If the USB connection is not detected, the software prompts the user to retry, exit the program, or enter the demo mode.

## Demo Mode

The MAX5432 EV kit software can enter the demo mode, when the USB connection is not detected, by pressing the **Cancel** button on the **MAX5432 Evaluation Kit Interface Circuit** popup window (Figure 2). The software can also enter the demo mode at any time using the **Options | Demo Mode** pulldown menu item in the main window. When in demo mode, all software communication to the EV kit circuit is disabled; however, most of the software GUI is functional. Demo mode allows the user to evaluate the software without hardware connectivity. To exit demo mode, select **Options | Demo Mode** from the pulldown menu.

## Wiper Position

The **Wiper Position** track bar in the **Potentiometer Control** group box can be used to change the wiper position between the H and L end points. Use the computer mouse or the keyboard **UP** and **DOWN** arrow keys to move the

wiper position between the 32 position points. The wiper position can also be changed by entering a numerical value between 0 and 31 into the **H-W Volatile** or **L-W Volatile** spin boxes, or by selecting the **up/down** buttons of these spin boxes. A change in the **Wiper Position** track bar, or **H-W Volatile/L-W Volatile** spin boxes will write to the volatile memory and the wiper position is updated with the data sent. The data in the nonvolatile memory remains unchanged. The wiper position is shown in the **H-W Volatile** and **L-W Volatile** spin boxes. The **H-W Volatile** spin box shows the wiper position with respect to the H end point and the **L-W Volatile** spin box shows the wiper position with respect to the L end point. During EV kit power-up, the wiper position data in the nonvolatile memory is transferred to the volatile memory and the position of the wiper is updated. The **H-W Volatile**, **L-W Volatile**, **H-W Nonvolatile**, and **L-W Nonvolatile** spin boxes display question marks (??) after initializing the EV kit software because the MAX5432 does not transmit data to the master.

## Nonvolatile Programming

The **H-W Nonvolatile** and **L-W Nonvolatile** spin boxes in the **Potentiometer Control** group box can be used to program the nonvolatile memory of the digital potentiometers. The nonvolatile memory can be changed by entering a numerical value between 0 and 31 into the **H-W Nonvolatile** or **L-W Nonvolatile** spin boxes. The **H-W Nonvolatile** spin box shows the wiper position with respect to the H end point and the **L-W Nonvolatile** spin box shows the wiper position with respect to the L end point. When writing to the nonvolatile memory, the volatile memory and wiper position remain unchanged.

## Volatile/Nonvolatile Data Transferring

The **Potentiometer Control** group box contains the **Store** and **Recall** buttons that are used to transfer data from the volatile memory to the nonvolatile memory and vice versa. When the **Store** button is pressed, the data present in the volatile memory is transferred to the nonvolatile memory.

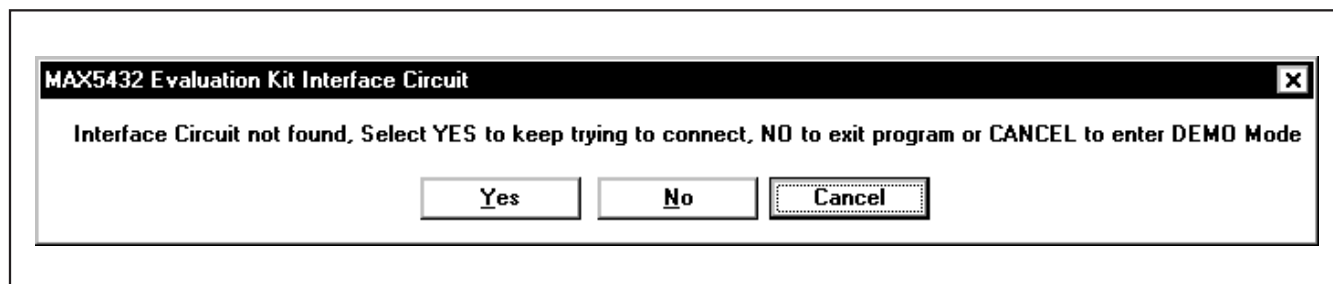

Figure 2. MAX5432 Evaluation Kit Interface Circuit Popup Window

# MAX5432 Evaluation Kit

Evaluates: MAX5432/MAX5433

When the **Recall** button is pressed, the data present in the nonvolatile memory is transferred to the volatile memory and the wiper position is updated. When either **Store** or **Recall** button is pressed, the EV kit software **Data Sent** indicator shows the last known data that is being transferred. These commands do not send any data to the device because the commands transferred data already contained in the volatile or nonvolatile memory.

### Factory Default

Pressing the **Factory Default** button resets the wiper position in the MAX5432 volatile and nonvolatile memory to the factory-default position. The factory-default wiper position is the midscale position.

### Device Address

The **Interface** group box contains a **Device Address** combo box that stores up to four device addresses found by the MAX5432 EV kit software. The MAX5432 EV kit software automatically searches for the MAX5432 during startup using the four possible addresses shown in Table 4. Each of the four unique device addresses found by the software will be stored in the **Device Address** combo box. Use the **Device Address** combo box to select between different devices that share the same bus. If no device is found, the **Device Address** is set to **Auto Detect**. Select the **Auto Detect** option from the **Device Address** combo box to search for new additional device addresses. A maximum of four MAX5432/MAX5433 devices can share the same I<sup>2</sup>C bus.

### Status Indicator

The **Status** indicator in the **Interface** group box displays **EV Kit Operational** when the MAX5432 EV kit enters the normal operating mode after the USB connection is detected and the device address is found. When USB connection is not detected or device is not found, or when the software enters the demo mode, the **Status** indicator displays **Device not found**.

### I<sup>2</sup>C Bus Speed Indicator

The **I<sup>2</sup>C Bus Speed** indicator in the **Interface** group box displays the I<sup>2</sup>C bus speed. The I<sup>2</sup>C bus speed is set to 400kbps by the MAX5432 EV kit software.

### Command Sent Indicator

The **Command Sent** indicator in the **Interface** group box displays the last command sent from the master (software) to the MAX5432. There are four commands available in the MAX5432 IC, as described in Table 1.

### Data Sent Indicator

The **Data Sent** indicator in the **Interface** group box displays the last data sent from the master (software) to the MAX5432. The MAX5432 IC uses the first 5 bits (MSBs, D7–D3) of the data byte to set the wiper position. The last 3 bits (D2, D1, and D0) are “Don’t Care’s.” Refer to the MAX5432/MAX5433 IC data sheet for additional information.

Table 1. MAX5432 I<sup>2</sup>C Command

MAX5432 REGISTER	COMMAND		DESCRIPTION	EV KIT SOFTWARE CONTROL
	BINARY	HEX		
VREG	00010001	0x11	I <sup>2</sup> C data is written to VREG Wiper position updates with I <sup>2</sup> C data No change to NVREG	H-W Volatile L-W Volatile
NVREG	00100001	0x21	I <sup>2</sup> C data is written to NVREG No change to wiper position No change to VREG	H-W Nonvolatile L-W Nonvolatile
VREGxNVREG	01010001	0x51	Copy VREG to NVREG No change to wiper position No change to VREG	Store
NVREGxVREG	01100001	0x61	Copy NVREG to VREG Wiper position updates with NVREG No change to NVREG	Recall

# MAX5432 Evaluation Kit

## Keyboard Navigation

Press the **TAB** key to select each GUI control. The selected control is indicated by a dotted outline. Using **SHIFT+TAB** moves the selection to the previously selected control. Buttons respond to the keyboard's **SPACE** bar. Some controls respond to the keyboard's **UP** and **DOWN** arrow keys. Activate the program's menu bar by pressing the **F10** key, then press the letter of the desired menu item. Most menu items have one letter underlined, indicating their shortcut key.

## Simple I<sup>2</sup>C Commands

There are two methods for communicating with the MAX5432 EV kit, through the normal user-interface panel (Figure 1) or by using low-level SMBus™ commands available through the **2-Wire Interface** utility from the main program's **Options | Interface (Advance Users)** main menu. A window is displayed (Figure 3) that allows I<sup>2</sup>C operations, such as **SMBusReadByte** and **SMBusWriteByte**. Do not use the **SMBusReadByte** operation because the MAX5432 does not send data to the master.

**Note:** The I<sup>2</sup>C dialog boxes accept numeric data in binary, decimal, or hexadecimal. Hexadecimal numbers must be prefixed by \$ or 0x. Binary numbers must be exactly eight binary digits. See Figure 3 for an example

of this tool. Figure 3 shows a simple SMBus write-byte operation using the included 2-wire interface diagnostics tool. In this example, the software is writing data 0xF8 to the register address 0x11 (write to volatile memory) to the device with the device address 0x50. The data sequence sets the MAX5432 wiper position to 32.

Refer to *Application Note 476*, at [www.maxim-ic.com](http://www.maxim-ic.com), for information and comparison of the SMBus and I<sup>2</sup>C protocols.

## General Troubleshooting

**Problem: Software reports it cannot find the interface circuit.**

- Is the interface circuit power LED lit?
- Is the USB cable connected?
- Has Windows plug-and-play detected the board? Bring up **Control Panel -> System -> Device Manager** and look at what device nodes are indicated for USB. If there is an "unknown device" node attached to the USB, delete it—this forces plug-and-play to try again.
- Are jumpers JU1–JU4 properly configured for USB operation?

*SMBus is a trademark of Intel Corporation.*

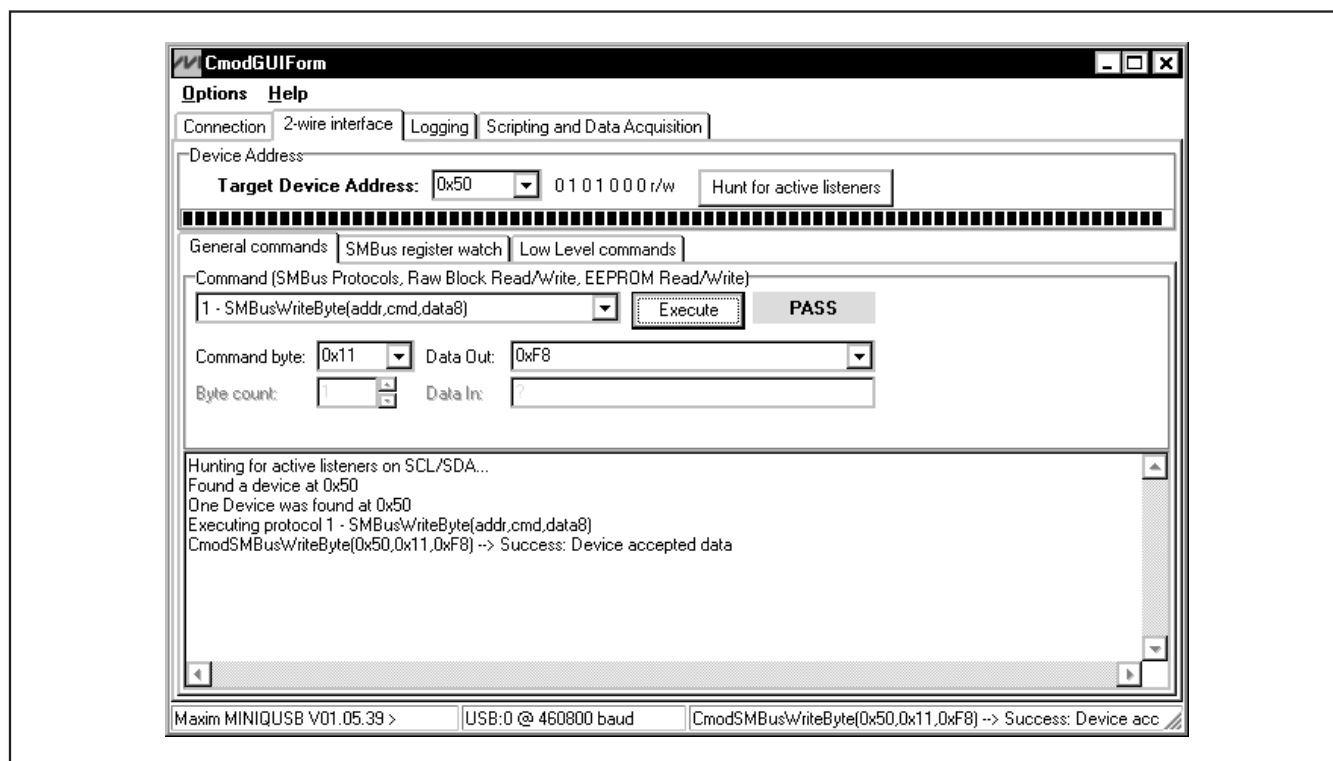

Figure 3. Simple Low-Level 2-Wire Interface

# MAX5432 Evaluation Kit

Evaluates: MAX5432/MAX5433

## Detailed Description of Hardware

The MAX5432 EV kit is an assembled and tested PCB that evaluates the MAX5432 linear digital potentiometer. The MAX5432 has an end-to-end resistance of 50kΩ and the wiper can be programmed among 32 tap positions. The MAX5432 features an internal nonvolatile memory (EEPROM) used to store the wiper position for initialization during power-up. The on-board I<sup>2</sup>C-compatible serial interface can communicate at rates up to 400kbps to program the MAX5432.

The EV kit uses a MAX5432 IC in an 8-pin TDFN package on a proven 2-layer PCB design. The MAX5432 EV kit provides two options to power the MAX5432 IC. It can operate from the 3.3V supply generated from the USB interface circuit, or from a user-supplied 2.7V to 5.25V external DC power supply. The MAX1840 logic level translators (U7, U8) provide proper I<sup>2</sup>C-interface operation when using a 2.7V to 5.25V external power supply.

### Jumper Selection

#### Using an External DC Power Supply

The MAX5432 EV kit can be powered by an external 2.7V to 5.25V DC power supply. The EV kit can still be programmed through the USB interface using the software GUI. To connect the EV kit to an external power supply, disconnect the USB cable and install a shunt on pins 2-3 of jumper JU1. Turn off the power supply and connect the power-supply ground terminal to the

EV kit GND pad; connect the power-supply positive terminal to the VIN pad. Table 2 lists the various options for powering the MAX5432 EV kit.

### I<sup>2</sup>C Clock and Data Inputs

The MAX5432 features clock and data input pins for I<sup>2</sup>C-compatible communication to control the MAX5432 wiper position. The clock and data input pins are driven by the on-board USB interface circuit or the PCB pads, along with the user-supplied external I<sup>2</sup>C-compatible controller. An external I<sup>2</sup>C-compatible controller can be connected to the SCL, SDA, and GND pads to communicate with the MAX5432 IC.

Jumpers JU2 and JU3 select the I<sup>2</sup>C serial-interface signal-control sources for the MAX5432 IC. Table 3 lists the various options for configuring I<sup>2</sup>C input signal controls.

### Address Selection (A0)

The MAX5432 EV kit circuit features a jumper that pulls the MAX5432 A0 address pin to VDD or GND to set the slave address. Table 4 shows four possible slave addresses for the MAX5432. The first 4 bits (MSBs) of the slave addresses are always 0101. Bits A2 and A1 are factory programmed (refer to the MAX5432/MAX5433 IC data sheet). Connect the A0 input to either GND or VDD to select the I<sup>2</sup>C device address for the MAX5432. When using multiple devices, each device must have a unique address to share the I<sup>2</sup>C bus. A maximum of four devices can concurrently share the same bus.

**Table 2. JU1 Jumper Functions (VDD)**

SHUNT POSITION	VDD PIN CONNECTED TO	EV KIT POWERED FROM
1-2*	3.3V	USB interface circuit
2-3	VIN	External power supply (2.7V to 5.25V)
Open	Not connected	Do not use (EV kit will not be powered)

\*Default position.

**Table 3. JU2 and JU3 Jumper Functions (SCL, SDA)**

SHUNT POSITION	I <sup>2</sup> C INTERFACE CONTROL SIGNALS CONNECTED TO	I <sup>2</sup> C INTERFACE SIGNALS CONTROLLED BY
Installed*	USB interface circuit	USB interface circuit and EV kit software
Not installed	PCB pads	User-supplied external I <sup>2</sup> C interface signals

\*Default position.

**Table 4. JU4 Jumper Functions (A0)**

SHUNT POSITION	A0 PIN CONNECTED TO	ADDRESS		PART
		BINARY	HEX	
Installed*	GND	010100A <sub>0</sub> Y	0x50	MAX5432LETA or MAX5433LETA
Not installed	VDD (through resistor R12)	010100A <sub>0</sub> Y	0x52	
Installed	GND	010110A <sub>0</sub> Y	0x58	MAX5432META or MAX5433META
Not installed	VDD (through resistor R12)	010110A <sub>0</sub> Y	0x5A	

\*Default position.

## MAX5432 Evaluation Kit

**Note:** The first 7 bits shown are the address. The Y bit in Table 4 is the I<sup>2</sup>C read/write bit. The I<sup>2</sup>C protocol states that this bit is a 1 for a read operation or a 0 for a write operation. The Y bit is always set to 0 (write only) because these digital potentiometers do not transmit data to the master device (no readback).

### Potentiometer or Variable Resistor With or Without Ground Reference

The MAX5432 EV kit provides an option to configure the MAX5432 as a potentiometer, a variable resistor, a potentiometer with ground reference, or a variable resistor with ground reference, using jumpers JU5 and JU6. Table 5 lists the various JU5 and JU6 jumper options.

### Evaluating the MAX5432META, MAX5433LETA, or MAX5433META

The MAX5432 EV kit can also evaluate the MAX5432META, MAX5433LETA, or the MAX5433META. Remove the MAX5432LETA IC (U1) and replace it with the desired IC. The MAX5432META, MAX5433LETA, and MAX5433META ICs are pin and functional compatible with the MAX5432LETA IC. Refer to the MAX5432/MAX5433 IC data sheet for a complete description of part-to-part differences.

**Table 5. JU5 and JU6 Jumper Functions (L Signal and GND)**

SHUNT POSITION		L AND GND PADS	H AND W PADS	EV KIT FUNCTION
JU5	JU6			
Not installed*	Not installed*	Not connected	Not connected	Potentiometer
Not installed	Installed	Not connected	Connected	Variable resistor
Installed	Not installed	Connected	Not connected	Potentiometer with ground reference
Installed	Installed	Connected	Connected	Variable resistor with ground reference

\*Default position.

# MAX5432 Evaluation Kit

Evaluates: MAX5432/MAX5433

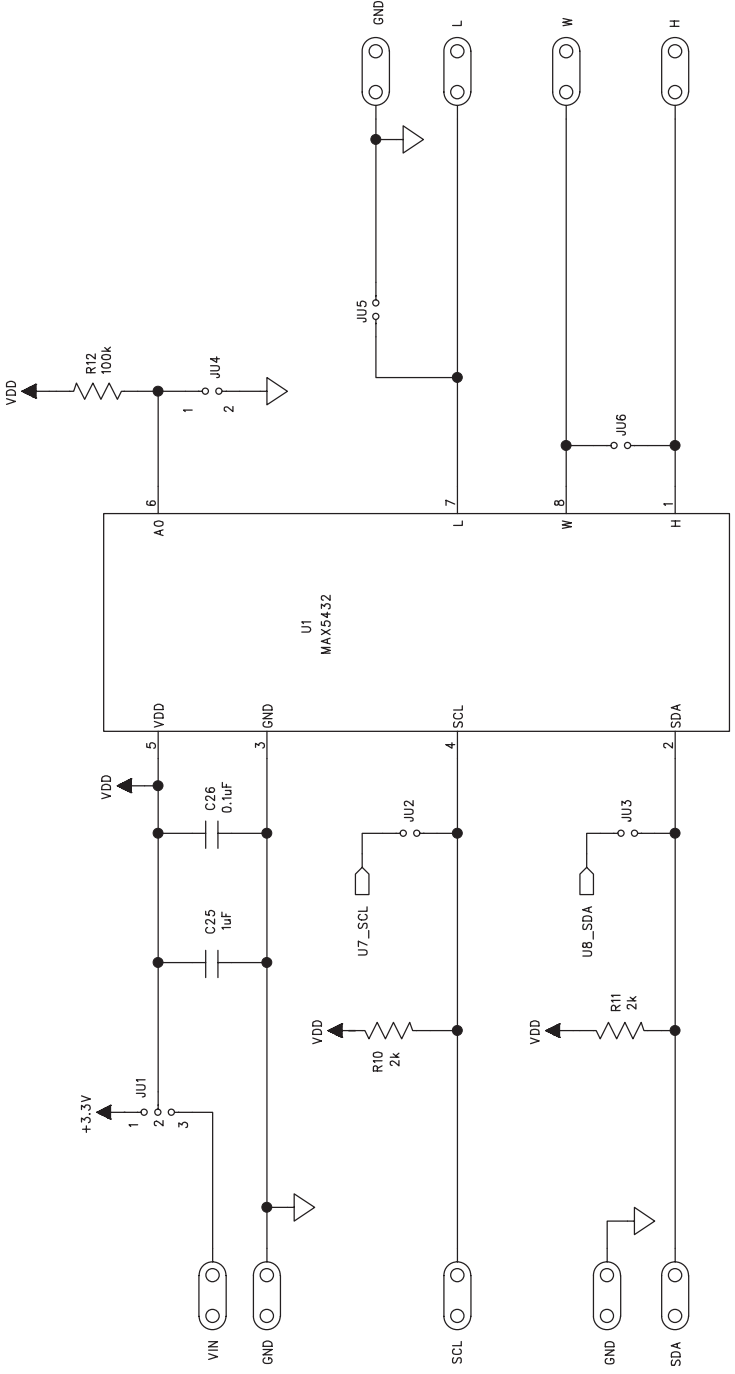

Figure 4a. MAX5432 EV Kit Schematic (Sheet 1 of 2)

# MAX5432 Evaluation Kit

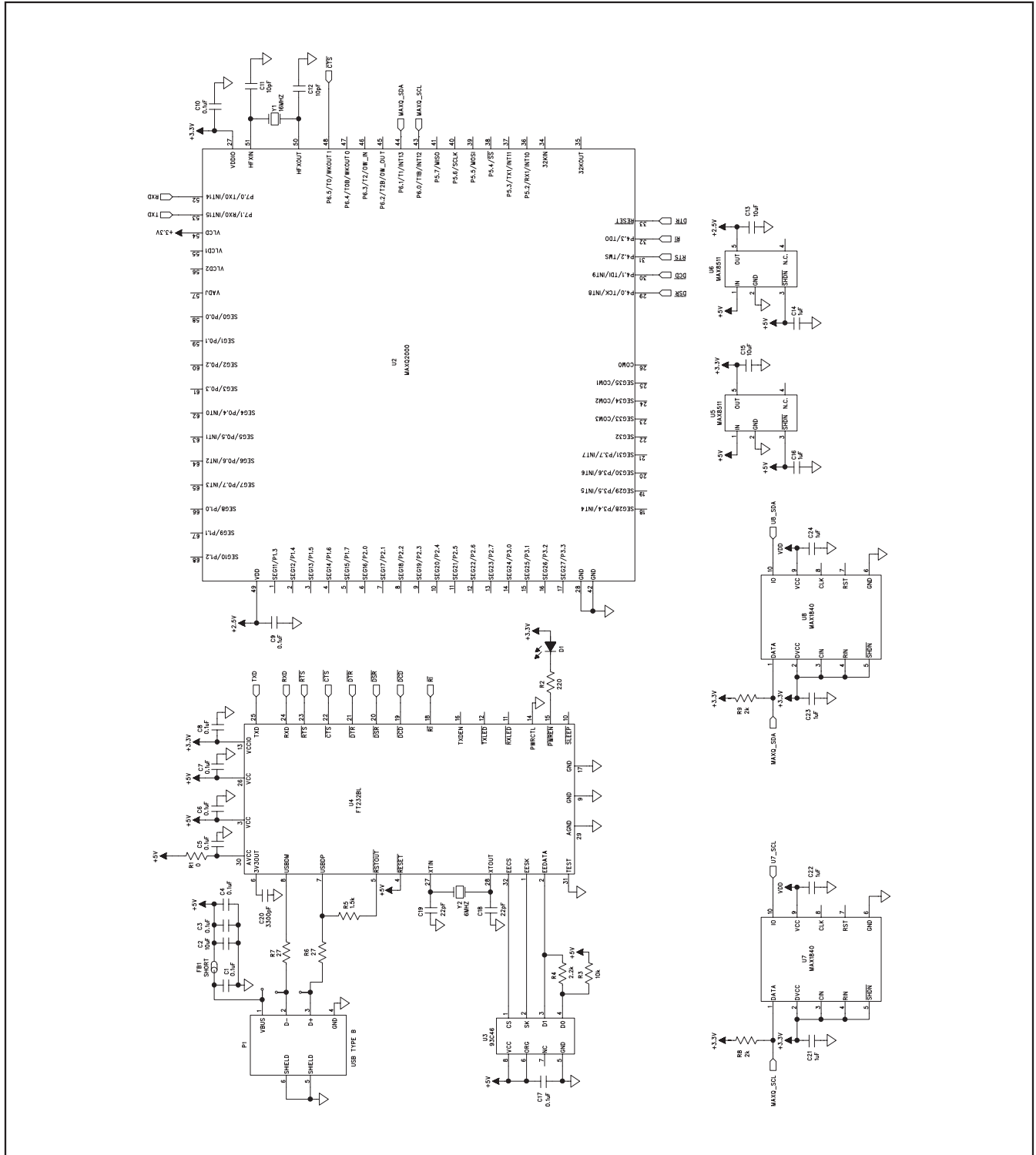

Figure 4b. MAX5432 EV Kit Schematic (Sheet 2 of 2)

# MAX5432 Evaluation Kit

Evaluates: MAX5432/MAX5433

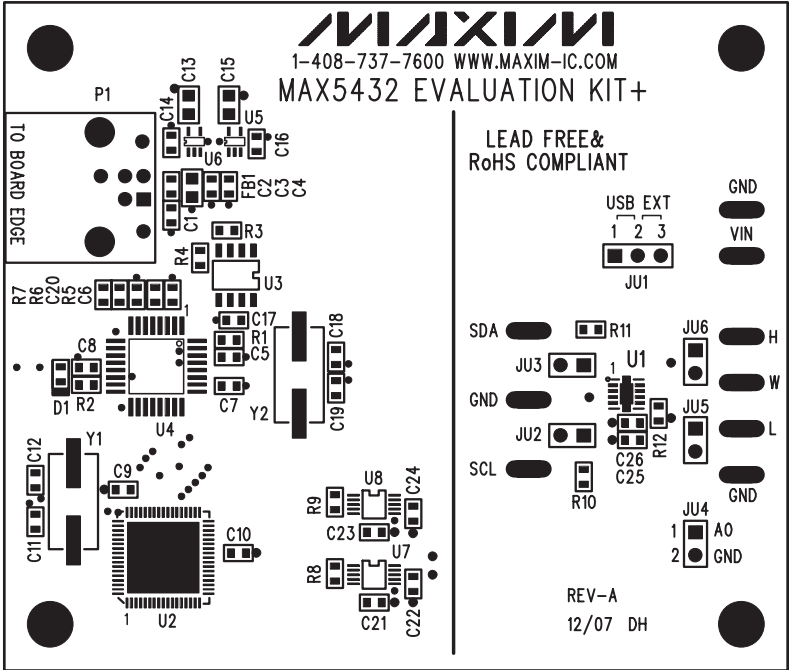

Figure 5. MAX5432 EV Kit Component Placement Guide—Component Side

# MAX5432 Evaluation Kit

**Evaluates: MAX5432/MAX5433**

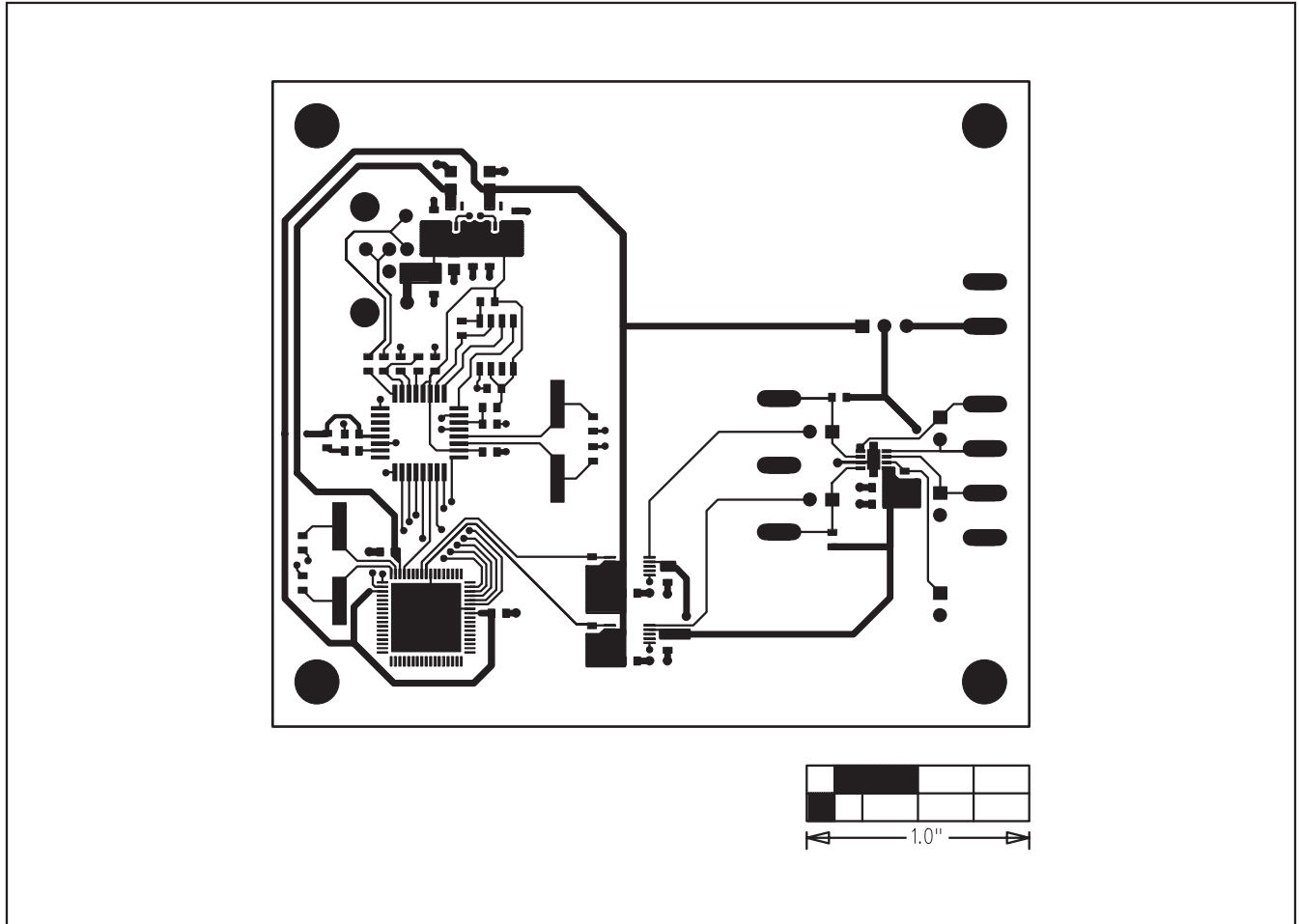

Figure 6. MAX5432 EV Kit PCB Layout—Component Side

# MAX5432 Evaluation Kit

Evaluates: MAX5432/MAX5433

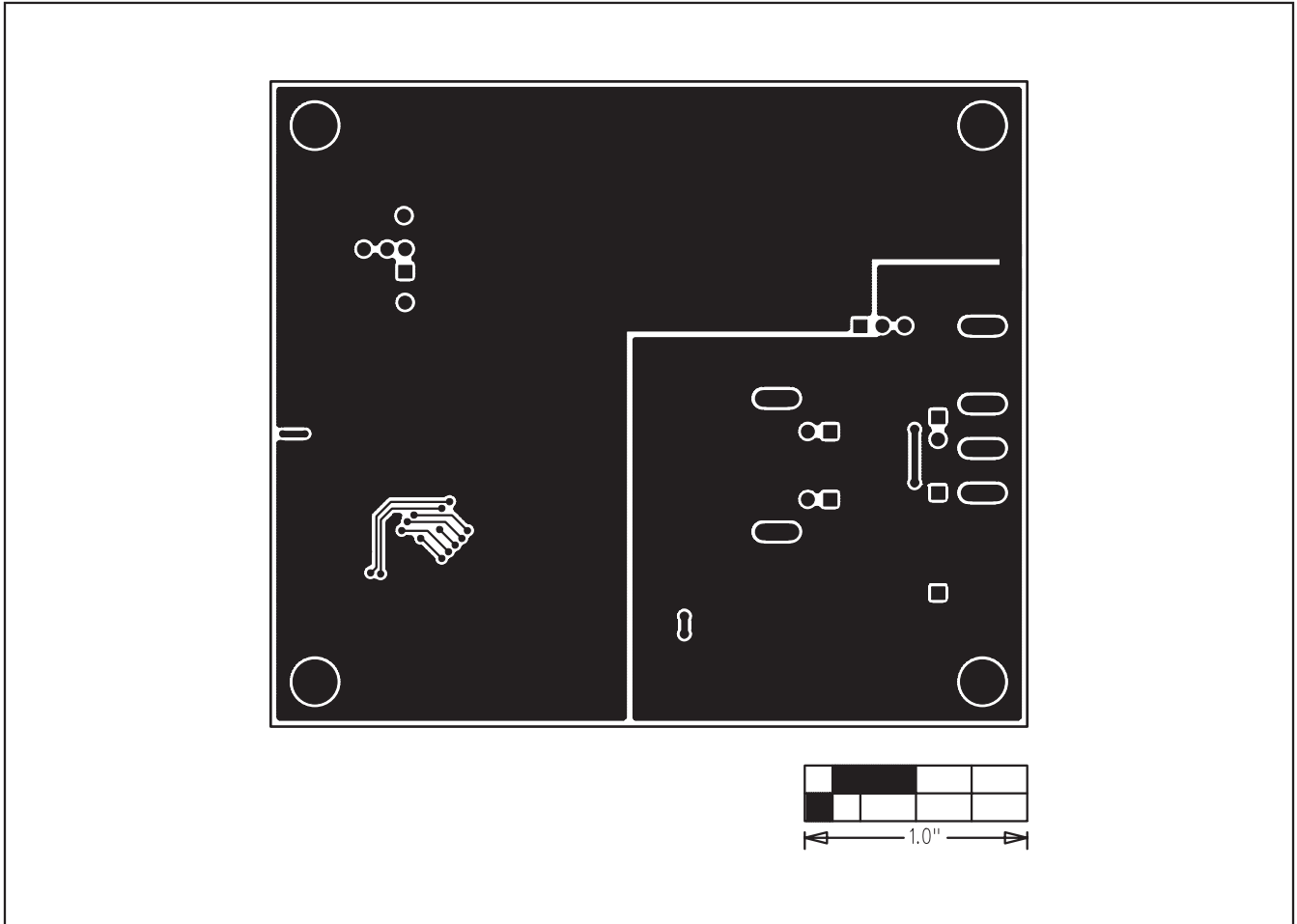

Figure 7. MAX5432 EV Kit PCB Layout—Solder Side

Maxim cannot assume responsibility for use of any circuitry other than circuitry entirely embodied in a Maxim product. No circuit patent licenses are implied. Maxim reserves the right to change the circuitry and specifications without notice at any time.

Maxim Integrated Products, 120 San Gabriel Drive, Sunnyvale, CA 94086 408-737-7600 \_\_\_\_\_ 13

## Looking for pricing, stock, or lifecycle information?

Click below to explore more details on WIN SOURCE:

 [View MAX5432EVKIT+ on WIN SOURCE](#)

 [Maxim Integrated Information](#)

## Optimize Your Supply Chain with WIN SOURCE Solutions

-  Global Sourcing Solution
-  Obsolete Management
-  Cost Control Management
-  Shortage Management
-  Alternative Solution
-  Excess Inventory Management