



**THE DATASHEET OF
MAX531BESD+**





+5V, Low-Power, Voltage-Output, Serial 12-Bit DACs

MAX531/MAX538/MAX539

General Description

The MAX531/MAX538/MAX539 are low-power, voltage-output, 12-bit digital-to-analog converters (DACs) specified for single +5V power-supply operation. The MAX531 can also be operated with $\pm 5V$ supplies. The MAX538/MAX539 draw only 140 μA , and the MAX531 (with internal reference) draws only 260 μA . The MAX538/MAX539 come in 8-pin DIP and SO packages, while the MAX531 comes in 14-pin DIP and SO packages. All parts have been trimmed for offset voltage, gain, and linearity, so no further adjustment is necessary. The MAX538's buffer is fixed at a gain of +1 and the MAX539's buffer at a gain of +2. The MAX531's internal op amp may be configured for a gain of +1 or +2, as well as for unipolar or bipolar output voltages. The MAX531 can also be used as a four-quadrant multiplier without external resistors or op amps. For parallel data inputs, see the MAX530 data sheet.

Applications

- Battery-Powered Test Instruments
- Digital Offset and Gain Adjustment
- Battery-Operated/Remote Industrial Controls
- Machine and Motion Control Devices
- Cellular Telephones

Functional Diagram

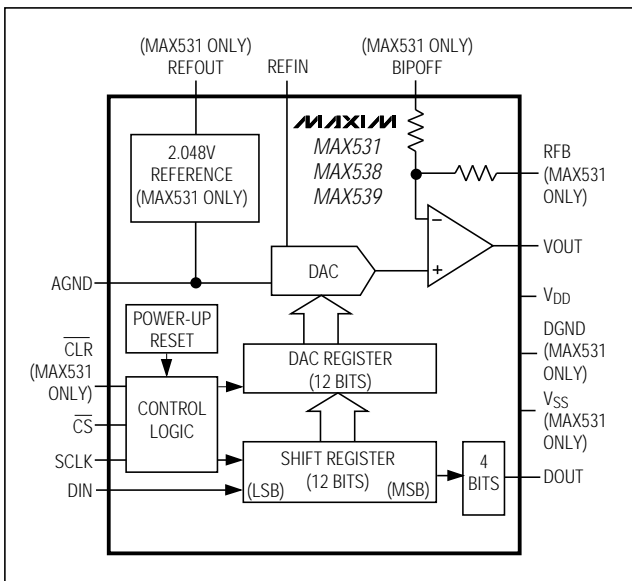

Features

- ◆ Operate from Single +5V Supply
- ◆ Buffered Voltage Output
- ◆ Internal 2.048V Reference (MAX531)
- ◆ 140 μA Supply Current (MAX538/MAX539)
- ◆ INL = $\pm 1/2$ LSB (max)
- ◆ Guaranteed Monotonic over Temperature
- ◆ Flexible Output Ranges:
 - 0V to V_{DD} (MAX531/MAX539)
 - V_{SS} to V_{DD} (MAX531)
 - 0V to 2.6V (MAX531/MAX538)
- ◆ 8-Pin SO/DIP (MAX538/MAX539)
- ◆ Power-On Reset
- ◆ Serial Data Output for Daisy-Chaining

Ordering Information

PART	TEMP. RANGE	PIN-PACKAGE	ERROR (LSB)
MAX531ACPD	0°C to +70°C	14 Plastic DIP	$\pm 1/2$
MAX531BCPD	0°C to +70°C	14 Plastic DIP	± 1
MAX531ACSD	0°C to +70°C	14 SO	$\pm 1/2$
MAX531BCSD	0°C to +70°C	14 SO	± 1
MAX531BC/D	0°C to +70°C	Dice*	± 1

Ordering Information continued at end of data sheet.

*Dice are specified at $T_A = +25^\circ C$ only.

Pin Configurations



Pin Configurations continued at end of data sheet.



+5V, Low-Power, Voltage-Output Serial 12-Bit DACs

ABSOLUTE MAXIMUM RATINGS

V _{DD} to DGND and V _{DD} to AGND	-0.3V, +6V	Continuous Power Dissipation (T _A = +70°C)	
V _{SS} to DGND and V _{SS} to AGND	-6V, +0.3V	8-Pin Plastic DIP (derate 9.09mW/°C above +70°C)	727mW
V _{DD} to V _{SS}	-0.3V, +12V	8-Pin SO (derate 5.88mW/°C above +70°C)	471mW
AGND to DGND	-0.3V, +0.3V	14-Pin Plastic DIP (derate 10.00mW/°C above +70°C)	800mW
Digital Input Voltage to DGND	-0.3V, (V _{DD} + 0.3V)	14-Pin SO (derate 8.33mW/°C above +70°C)	667mW
REFIN	(V _{SS} - 0.3V), (V _{DD} + 0.3V)	Operating Temperature Ranges	
REFOUT to AGND	-0.3V, (V _{DD} + 0.3V)	MAX53_ _C_ _	0°C to +70°C
RFB	(V _{SS} - 0.3V), (V _{DD} + 0.3V)	MAX53_ _E_ _	-40°C to +85°C
BIPOFF	(V _{SS} - 0.3V), (V _{DD} + 0.3V)	Storage Temperature Range	-65°C to +165°C
V _{OUT} (Note 1)	V _{SS} , V _{DD}	Lead Temperature (soldering, 10sec)	+300°C
Continuous Current, Any Pin	-20mA, +20mA		

Note 1: The output may be shorted to V_{DD}, V_{SS}, or AGND if the package power dissipation limit is not exceeded.

Stresses beyond those listed under "Absolute Maximum Ratings" may cause permanent damage to the device. These are stress ratings only, and functional operation of the device at these or any other conditions beyond those indicated in the operational sections of the specifications is not implied. Exposure to absolute maximum rating conditions for extended periods may affect device reliability.

ELECTRICAL CHARACTERISTICS—Single +5V Supply

(V_{DD} = +5V ±10%, V_{SS} = 0V, AGND = DGND = 0V, REFIN = 2.048V (external), RFB = BIPOFF = V_{OUT} (MAX531), C_{REFOUT} = 33μF (MAX531), R_L = 10kΩ, C_L = 100pF, T_A = T_{MIN} to T_{MAX}, unless otherwise noted.)

PARAMETER	SYMBOL	CONDITIONS	MIN	TYP	MAX	UNITS
STATIC PERFORMANCE						
Resolution	N		12			Bits
Relative Accuracy (Note 2)	INL	MAX53_AC/E			±0.5	LSB
		MAX53_BC/E			±1	
Differential Nonlinearity	DNL	Guaranteed monotonic			±1	LSB
Unipolar Offset Error	V _{OS}	MAX53_ _C/E	0		8	LSB
Unipolar Offset Tempco	TCV _{OS}			3		ppm/°C
Gain Error (Note 2)	GE	MAX53_ _C/E			±1	LSB
Gain-Error Tempco				1		ppm/°C
Power-Supply Rejection Ratio (Note 3)	PSRR	4.5V ≤ V _{DD} ≤ 5.5V		0.4	1	LSB/V
VOLTAGE OUTPUT (V_{OUT})						
Output Voltage Range		MAX531 (G = +1), MAX538	0		V _{DD} - 2	V
		MAX531 (G = +2), MAX539	0		V _{DD} - 0.4	
Output Load Regulation		V _{OUT} = 2V, R _L = 2kΩ			1	LSB
Short-Circuit Current	I _{SC}			12		mA
REFERENCE INPUT (REFIN)						
Voltage Range			0		V _{DD} - 2	V
Input Resistance		Code dependent, minimum at code 555 hex	40			kΩ
Input Capacitance		Code dependent (Note 4)	10		50	pF
AC Feedthrough		REFIN = 1kHz, 2Vp-p		-80		dB

+5V, Low-Power, Voltage-Output, Serial 12-Bit DACs

MAX531/MAX538/MAX539

ELECTRICAL CHARACTERISTICS—Single +5V Supply (continued)

($V_{DD} = +5V \pm 10\%$, $V_{SS} = 0V$, $AGND = DGND = 0V$, $REFIN = 2.048V$ (external), $RFB = BIPOFF = V_{OUT}$ (MAX531), $C_{REFOUT} = 33\mu F$ (MAX531), $R_L = 10k\Omega$, $C_L = 100pF$, $T_A = T_{MIN}$ to T_{MAX} , unless otherwise noted.)

PARAMETER	SYMBOL	CONDITIONS	MIN	TYP	MAX	UNITS	
REFERENCE OUTPUT (REFOUT—MAX531 only)							
Reference Output Voltage		$V_{DD} = 5.0V$	$T_A = +25^\circ C$	2.024	2.048	2.072	V
			MAX531BC	2.017		2.079	
			MAX531BE	2.013		2.083	
Temperature Coefficient	$T_{CREFOUT}$	MAX531AC/AE/AM/BM		30	50	ppm/ $^\circ C$	
		MAX531BC/BE		30			
Resistance	R_{REFOUT}	(Note 5)		0.5	2	Ω	
Power-Supply Rejection Ratio	PSRR	$4.5V \leq V_{DD} \leq 5.5V$			300	$\mu V/V$	
Noise Voltage	e_n	0.1Hz to 10kHz		400		μV_{p-p}	
Minimum Required External Capacitor	C_{MIN}		3.3			μF	
DIGITAL INPUTS (DIN, SCLK, \overline{CS}, CLR)							
Input High	V_{IH}		2.4			V	
Input Low	V_{IL}				0.8	V	
Input Current	I_{IN}	$V_{IN} = 0V$ or V_{DD}			± 1	μA	
Input Capacitance	C_{IN}			8		pF	
DIGITAL OUTPUT (DOUT)							
Output High	V_{OH}	$I_{SOURCE} = 2mA$	$V_{DD} - 1$			V	
Output Low	V_{OL}	$I_{SINK} = 2mA$			0.4	V	
DYNAMIC PERFORMANCE							
Voltage-Output Slew Rate	SR	$T_A = +25^\circ C$	0.15	0.25		V/ μs	
Voltage-Output Settling Time		$T_o \pm 1/2LSB$, $V_{OUT} = 2V$		25		μs	
Digital Feedthrough		$\overline{CS} = V_{DD}$, $DIN = 100kHz$		5		nV-s	
Signal-to-Noise plus Distortion	SINAD	$REFIN = 1kHz$, $2V_{p-p}$ ($G = +1$ or $+2$), code = FFF hex		68		dB	
POWER SUPPLY							
Positive Supply Voltage	V_{DD}		4.5		5.5	V	
Power-Supply Current	I_{DD}	All inputs = 0V or V_{DD} , output = no load	MAX531	260	400	μA	
			MAX538, MAX539	140	300		
SWITCHING CHARACTERISTICS							
\overline{CS} Setup Time	t_{CSS}		20			ns	
SCLK Fall to \overline{CS} Fall Hold Time	t_{CSH0}		15			ns	
SCLK Fall to \overline{CS} Rise Hold Time	t_{CSH1}		0			ns	
SCLK High Width	t_{CH}		35			ns	
SCLK Low Width	t_{CL}		35			ns	
DIN Setup Time	t_{DS}		45			ns	
DIN Hold Time	t_{DH}		0			ns	
DOUT Valid Propagation Delay	t_{DO}	$C_L = 50pF$			80	ns	
\overline{CS} High Pulse Width	t_{CSW}		20			ns	
CLR Pulse Width	t_{CLR}		25			ns	
\overline{CS} Rise to SCLK Rise Setup Time	t_{CS1}		50			ns	

+5V, Low-Power, Voltage-Output, Serial 12-Bit DACs

MAX531/MAX538/MAX539

ELECTRICAL CHARACTERISTICS—Dual Supplies (MAX531 Only)

($V_{DD} = +5V \pm 10\%$, $V_{SS} = -5V \pm 10\%$, $AGND = DGND = 0V$, $REFIN = 2.048V$ (external), $RFB = BIPOFF = VOUT$, $C_{REFOUT} = 33\mu F$, $R_L = 10k\Omega$, $C_L = 100pF$, $T_A = T_{MIN}$ to T_{MAX} , unless otherwise noted.)

PARAMETER	SYMBOL	CONDITIONS	MIN	TYP	MAX	UNITS	
Resolution	N		12			Bits	
Relative Accuracy	INL	Tested at $V_{DD} = 5V$, $V_{SS} = -5V$			± 0.5	LSB	
			MAX531AC/E				
					± 1		
Differential Nonlinearity	DNL	Guaranteed monotonic			± 1	LSB	
Bipolar Offset Error	V_{OS}	$BIPOFF = REFIN$, MAX531_C/E			± 8	LSB	
Bipolar Offset Tempco	TCV_{OS}	$BIPOFF = REFIN$		3		ppm/ $^{\circ}C$	
Gain Error (Unipolar or Bipolar)	GEU	MAX531_C/E			± 1	LSB	
Gain-Error Tempco				1		ppm/ $^{\circ}C$	
Power-Supply Rejection Ratio (Note 3)	PSRR	$4.5V \leq V_{DD} \leq 5.5V$, $-5.5V \leq V_{SS} \leq -4.5V$		0.4	1	LSB/V	
REFERENCE INPUT (REFIN)							
Voltage Range			$V_{SS} + 2$		$V_{DD} - 2$	V	
Input Resistance		Code dependent, minimum at code 555 hex	40			k Ω	
Input Capacitance		Code dependent (Note 4)	10		50	pF	
AC Feedthrough		$REFIN = 1kHz$, 2.0Vp-p		-80		dB	
REFERENCE OUTPUT (REFOUT—MAX531 only)							
Reference Output Voltage		$V_{DD} = 5.0V$	$T_A = +25^{\circ}C$	2.024	2.048	2.072	V
			MAX531BC	2.017		2.079	
			MAX531BE	2.013		2.083	
Temperature Coefficient	TC_{REFOUT}	MAX531AC/AE/AM/BM		30	50	ppm/ $^{\circ}C$	
		MAX531BC/BE		30			
Resistance	R_{REFOUT}	(Note 5)		0.5	2	Ω	
Power-Supply Rejection Ratio	PSRR	$4.5V \leq V_{DD} \leq 5.5V$			300	$\mu V/V$	
Noise Voltage	e_n	0.1Hz to 10kHz		400		$\mu Vp-p$	
Minimum Required External Capacitor	C_{MIN}		3.3			μF	
DIGITAL INPUTS (DIN, SCLK, \overline{CS})							
Input High	V_{IH}		2.4			V	
Input Low	V_{IL}				0.8	V	
Input Current	I_{IN}	$V_{IN} = 0V$ or V_{DD}			± 1	μA	
Input Capacitance	C_{IN}			8		pF	
DIGITAL OUTPUT (DOUT)							
Output High	V_{OH}	$I_{SOURCE} = 2mA$	$V_{DD} - 1$			V	
Output Low	V_{OL}	$I_{SINK} = 2mA$			0.4	V	

+5V, Low-Power, Voltage-Output, Serial 12-Bit DACs

MAX531/MAX538/MAX539

ELECTRICAL CHARACTERISTICS—Dual Supplies (MAX531 Only) (continued)

($V_{DD} = +5V \pm 10\%$, $V_{SS} = -5V \pm 10\%$, $AGND = DGND = 0V$, $REFIN = 2.048V$ (external), $RFB = BIPOFF = VOUT$, $C_{REFOUT} = 33\mu F$, $R_L = 10k\Omega$, $C_L = 100pF$, $T_A = T_{MIN}$ to T_{MAX} , unless otherwise noted.)

PARAMETER	SYMBOL	CONDITIONS	MIN	TYP	MAX	UNITS
VOLTAGE OUTPUT (VOUT)						
Output Voltage Range		MAX531 (G = +1)	$V_{SS} + 2$	$V_{DD} - 2$		V
		MAX531 (G = +2)	$V_{SS} + 0.4$	$V_{DD} - 0.4$		
Output Load Regulation		$VOUT = 2V$, $R_L = 2k\Omega$			1	LSB
Short-Circuit Current	I_{SC}			12		mA
DYNAMIC PERFORMANCE						
Voltage-Output Slew Rate	SR		0.15	0.25		V/ μs
Voltage-Output Settling Time		To $\pm 1/2$ LSB, $VOUT = 2V$		25		μs
Digital Feedthrough		Step 000 hex to FFF hex		5		nV-s
Signal-to-Noise plus Distortion	SINAD	REFIN = 1kHz, 2Vp-p, (G = +1)		68		dB
		REFIN = 1kHz, 2Vp-p, (G = +2)		68		
POWER SUPPLY						
Positive Supply Voltage	V_{DD}		4.5		5.5	V
Negative Supply Voltage	V_{SS}		-5.5		0	V
Positive Supply Current	I_{DD}	All inputs = 0V or V_{DD} , no load		260	400	μA
Negative Supply Current	I_{SS}	All inputs = 0V or V_{DD} , no load		-120	-200	μA
SWITCHING CHARACTERISTICS						
\overline{CS} Setup Time	t_{CSS}		20			ns
SCLK Fall to \overline{CS} Fall Hold Time	t_{CSH0}		15			ns
SCLK Fall to \overline{CS} Rise Hold Time	t_{CSH1}		0			ns
SCLK High Width	t_{CH}		35			ns
SCLK Low Width	t_{CL}		35			ns
DIN Setup Time	t_{DS}		45			ns
DIN Hold Time	t_{DH}		0			ns
DOUT Valid Propagation Delay	t_{DO}	$C_L = 50pF$			80	ns
\overline{CS} High Pulse Width	t_{CSW}		20			ns
\overline{CLR} Pulse Width	t_{CLR}		25			ns
\overline{CS} Rise to SCLK Rise Setup Time	t_{CS1}		50			ns

Note 2: In single-supply operation, INL and GE calculated from code 11 to code 4095. Tested at $V_{DD} = +5V$.

Note 3: This specification applies to both gain-error power-supply rejection ratio and offset-error power-supply rejection ratio.

Note 4: Guaranteed by design.

Note 5: Tested at $I_{OUT} = 100\mu A$. The reference can typically source up to 5mA (see *Typical Operating Characteristics*).

+5V, Low-Power, Voltage-Output, Serial 12-Bit DACs

Typical Operating Characteristics

($V_{DD} = +5V$, $V_{REFIN} = 2.048V$, $T_A = +25^\circ C$, unless otherwise noted.)

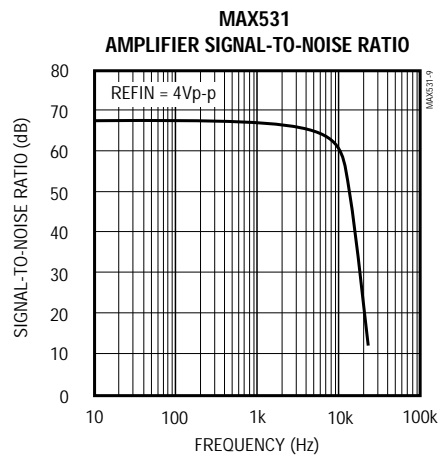
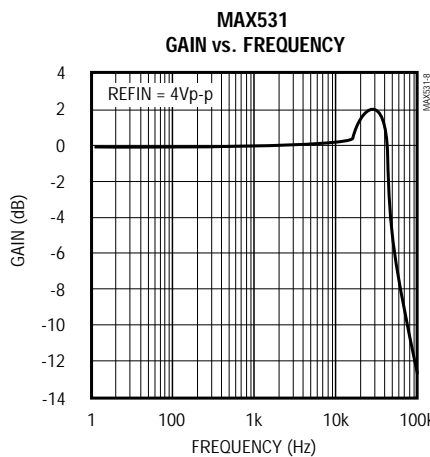
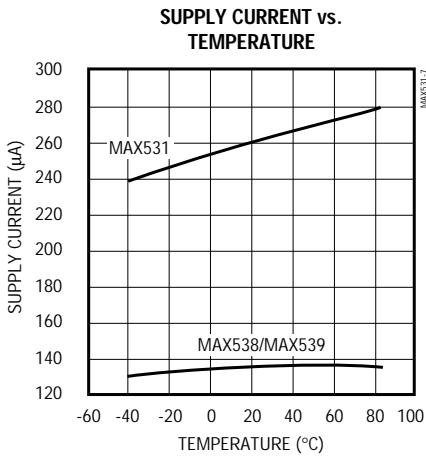
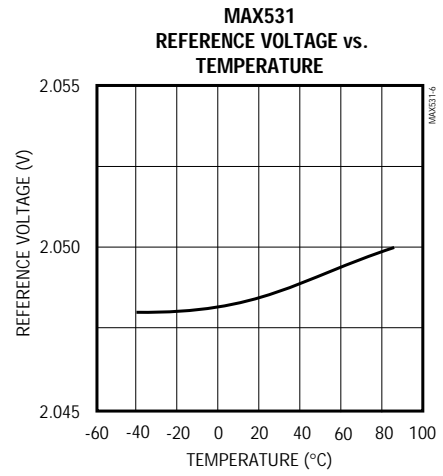
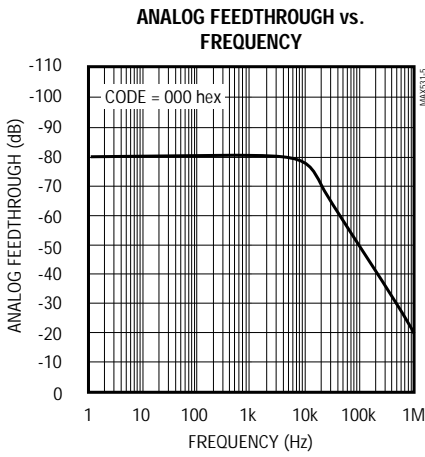
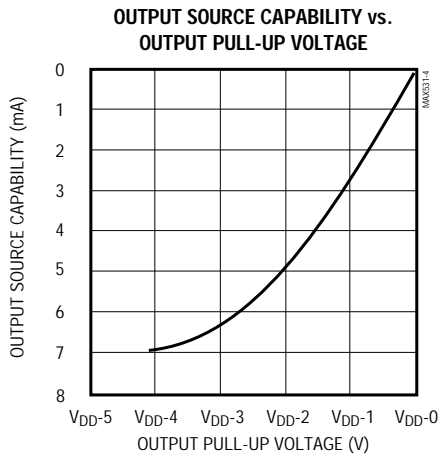
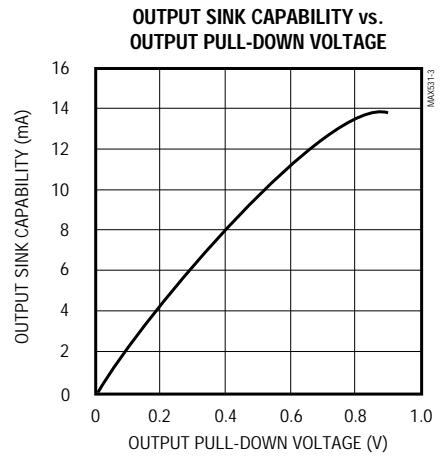

+5V, Low-Power, Voltage-Output, Serial 12-Bit DACs

MAX531/MAX538/MAX539

Typical Operating Characteristics (continued)

($V_{DD} = +5V$, $V_{REFIN} = 2.048V$, $T_A = +25^\circ C$, unless otherwise noted.)

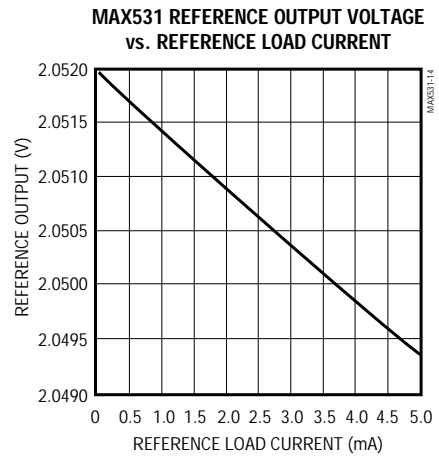

DIGITAL FEEDTHROUGH

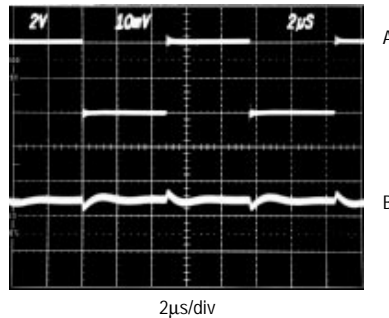

$\overline{CS} = \text{HIGH}$
A: DIN = 4Vp-p, 100kHz
B: VOUT, 10mV/div

NEGATIVE SETTLING TIME (MAX531)

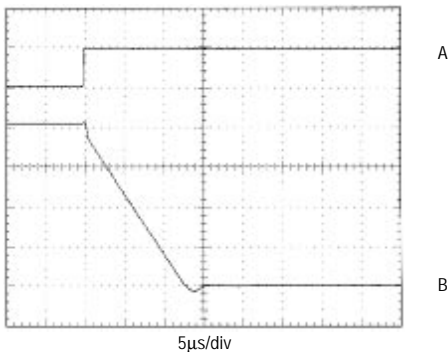

$V_{DD} = \pm 5V$, $V_{REFIN} = 2V$, BIPOLAR CONFIGURATION
A: CS RISING EDGE, 5V/div
B: VOUT, NO LOAD, 1V/div

POSITIVE SETTLING TIME (MAX531)

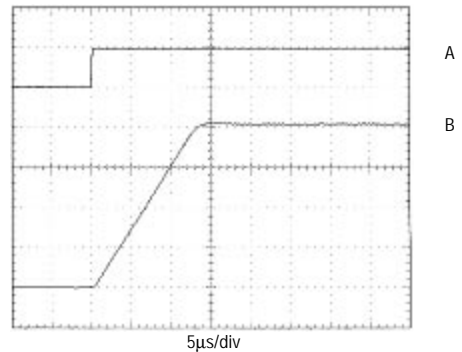

$V_{DD} = \pm 5V$, $V_{REFIN} = 2V$, BIPOLAR CONFIGURATION
A: CS RISING EDGE, 5V/div
B: VOUT, NO LOAD, 1V/div

+5V, Low-Power, Voltage-Output Serial 12-Bit DACs

Pin Description

PIN		NAME	FUNCTION
MAX531	MAX538 MAX539		
1	—	BIPOFF	Bipolar Offset/Gain Resistor
2	1	DIN	Serial Data Input
3	—	$\overline{\text{CLR}}$	Clear. Asynchronously sets DAC register to 000 hex.
4	2	SCLK	Serial Clock Input
5	3	$\overline{\text{CS}}$	Chip Select, active low
6	4	DOUT	Serial Data Output for daisy-chaining
7	—	DGND	Digital Ground
8	5	AGND	Analog Ground
9	6	REFIN	Reference Input
10	—	REFOUT	Reference Output, 2.048V
11	—	V _{SS}	Negative Power Supply
12	7	VOUT	DAC Output
13	8	V _{DD}	Positive Power Supply
14	—	RFB	Feedback Resistor

Detailed Description

General DAC Discussion

The MAX531/MAX538/MAX539 use an “inverted” R-2R ladder network with a single-supply CMOS op amp to convert 12-bit digital data to analog voltage levels (see *Functional Diagram*). The term “inverted” describes the ladder network because the REFIN pin in current-output DACs is the summing junction, or virtual ground, of an op amp. However, such use would result in the output voltage being the inverse of the reference voltage. The MAX531/MAX538/MAX539’s topology makes the output the same polarity as the reference input.

An internal reset circuit forces the DAC register to reset to 000 hex on power-up. Additionally, a clear $\overline{\text{CLR}}$ pin, when held low, sets the DAC register to 000 hex. $\overline{\text{CLR}}$ operates asynchronously and independently from the chip-select ($\overline{\text{CS}}$) pin.

Buffer Amplifier

The output buffer is a unity-gain stable, rail-to-rail output, BiCMOS op amp. Input offset voltage and CMRR are trimmed to achieve better than 12-bit performance. Settling time is 25 μ s to 0.01% of final value. The settling time is considerably longer when the DAC code is initially set to 000 hex, because at this code the op amp is completely debiased. Start from code 001 hex if necessary. The output is short-circuit protected and can drive a 2k Ω load with more than 100pF load capacitance.



Figure 1. Timing Diagram

+5V, Low-Power, Voltage-Output, Serial 12-Bit DACs



Figure 2. Reference Noise vs. Frequency

Internal Reference (MAX531 only)

The on-chip reference is laser trimmed to generate 2.048V at REFOUT. The output stage can source and sink current, so REFOUT can settle to the correct voltage quickly in response to code-dependent loading changes. Typically, source current is 5mA and sink current is 100 μA .

REFOUT connects the internal reference to the R-2R DAC ladder at REFIN. The R-2R ladder draws 50 μA maximum load current. If any other connection is made to REFOUT, ensure that the total load current is less than 100 μA to avoid gain errors.

For applications requiring very low-noise performance, connect a 33 μF capacitor from REFOUT to AGND. If noise is not a concern, a lower value capacitor (3.3 μF min) may be used. To reduce noise further, insert a buffered RC filter between REFOUT and REFIN (Figure 2). The reference bypass capacitor, C_{REFOUT} , is still required for reference stability. In applications not requiring the reference, connect REFOUT to V_{DD} or use the MAX538 or MAX539 (no internal reference).

External Reference

An external reference in the range ($V_{\text{SS}} + 2\text{V}$) to ($V_{\text{DD}} - 2\text{V}$) may be used with the MAX531 in dual-supply operation. With the MAX538/MAX539 or the MAX531 in single-supply use, the reference must be positive and may not exceed $V_{\text{DD}} - 2\text{V}$. The reference voltage determines the DAC's full-scale output. The DAC input resistance is code dependent and is minimum (40k Ω) at code 555 hex and virtually infi-

nite at code 000 hex. REFIN's input capacitance is also code dependent and has a 50pF maximum value at several codes. Because of the code-dependent nature of reference input impedances, a high-quality, low-output-impedance amplifier (such as the MAX480 low-power, precision op amp) should be used.

If an upgrade to the internal reference is required, the 2.5V MAX873A is suitable: $\pm 15\text{mV}$ initial accuracy, $\text{TCV}_{\text{OUT}} = 7\text{ppm}/^\circ\text{C}$ (max).

Logic Interface

The MAX531/MAX538/MAX539 logic inputs are designed to be compatible with TTL or CMOS logic levels. However, to achieve the lowest power dissipation, drive the digital inputs with rail-to-rail CMOS logic. With TTL logic levels, the power requirement increases by a factor of approximately 2.

Serial Clock and Update Rate

Figure 1 shows the MAX531/MAX538/MAX539 timing. The maximum serial clock rate is given by $1 / (t_{\text{CH}} + t_{\text{CL}})$, approximately 14MHz. The digital update rate is limited by the chip-select period, which is $16 \times (t_{\text{CH}} + t_{\text{CL}}) + t_{\text{CSW}}$. This equals a 1.14 μs , or 877kHz, update rate. However, the DAC settling time to 12 bits is 25 μs , which may limit the update rate to 40kHz for full-scale step transitions.

Applications Information

Refer to Figures 3a and 3b for typical operating connections.

Serial Interface

The MAX531/MAX538/MAX539 use a three-wire serial interface that is compatible with SPI™, QSPI™ (CPOL = CPHA = 0), and Microwire™ standards as shown in Figures 4 and 5. The DAC is programmed by writing two 8-bit words (see Figure 1 and the *Functional Diagram*). Sixteen bits of serial data are clocked into the DAC MSB first with the MSB preceded by four fill (dummy) bits. The four dummy bits are not normally needed. They are required **only** when DACs are daisy-chained. Data is clocked in on SCLK's rising edge while $\overline{\text{CS}}$ is low. The serial input data is held in a 16-bit serial shift register. On $\overline{\text{CS}}$'s rising edge, the 12 least significant bits are transferred to the DAC register and update the DAC. With $\overline{\text{CS}}$ high, data cannot be clocked into the MAX531/MAX538/MAX539.

The MAX531/MAX538/MAX539 input data in 16-bit blocks. The SPI and Microwire interfaces output data in 8-bit blocks, thereby requiring two write cycles to input data to the DAC. The QSPI interface allows variable data input from eight to 16 bits, and can be loaded into the DAC in one write cycle.

*SPI and QSPI are trademarks of Motorola, Inc.
Microwire is a trademark of National Semiconductor Corp.*

+5V, Low-Power, Voltage-Output, Serial 12-Bit DACs

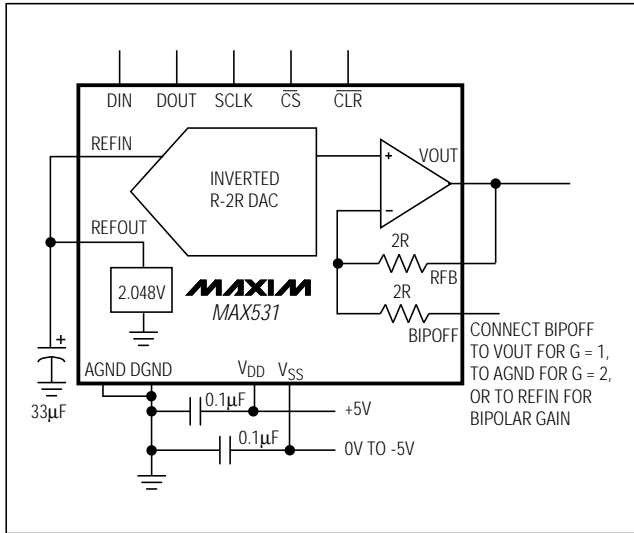

Figure 3a. MAX531 Typical Operating Circuit

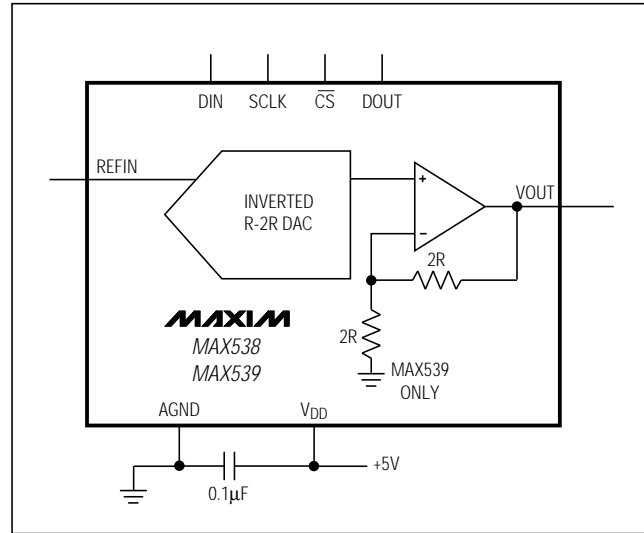

Figure 3b. MAX538/MAX539 Typical Operating Circuit

Daisy-Chaining Devices

The serial output, DOUT, allows cascading of two or more DACs. The data at DIN appears at DOUT, delayed by 16 clock cycles plus one clock width. For low power, DOUT is a CMOS output that does not require an external pull-up resistor. DOUT does **not** go into a high-impedance state when \overline{CS} is high. DOUT changes on SCLK's falling edge when \overline{CS} is low. When \overline{CS} is high, DOUT remains in the state of the last data bit.

Any number of MAX531/MAX538/MAX539 DACs can be daisy-chained by connecting the DOUT of one device to the DIN of the next device in the chain. For proper timing, ensure that t_{CL} (\overline{CS} low to SCLK high) is greater than $t_{DO} + t_{DS}$.

Unipolar Configuration

The MAX531 is configured for a gain of +1 (0V to V_{REFIN} unipolar output) by connecting BIPOFF and RFB to VOUT (Figure 6). The converter operates from either single or dual supplies in this configuration. See Table 1 for the DAC-latch contents (input) vs. the analog VOUT (output). In this range, $1\text{LSB} = V_{REFIN} (2^{-12})$. The MAX538 is internally configured for unipolar gain = +1 operation.

A gain of +2 (0V to $2V_{REFIN}$ unipolar output) is set up by connecting BIPOFF to AGND and RFB to VOUT (Figure 7). Table 2 shows the DAC-latch contents vs. VOUT. The MAX531 operates from either single or dual

supplies in this mode. In this range, $1\text{LSB} = (2)(V_{REFIN}) (2^{-12}) = (V_{REFIN})(2^{-11})$. The MAX539 is internally configured for unipolar gain = +2 operation.

Bipolar Configuration

A bipolar range is set up by connecting BIPOFF to REFOUT and RFB to VOUT, and operating from dual ($\pm 5\text{V}$) supplies (Figure 8). Table 3 shows the DAC-latch contents (input) vs. VOUT (output). In this range, $1\text{LSB} = V_{REFIN} (2^{-11})$.

Four-Quadrant Multiplication

The MAX531 can be used as a four-quadrant multiplier by connecting BIPOFF to REFOUT and RFB to VOUT, using (1) an offset binary digital code, (2) bipolar power supplies, using dual power supplies, and (3) a bipolar analog input at REFOUT within the range $V_{SS} + 2\text{V}$ to $V_{DD} - 2\text{V}$, as shown in Figure 9.

In general, a 12-bit DAC's output is $(D)(V_{REFIN})(G)$, where "G" is the gain (+1 or +2) and "D" is the binary representation of the digital input divided by 2^{12} or 4096. This formula is precise for unipolar operation. However, for bipolar, offset binary operation, the MSB is really a polarity bit. No resolution is lost, as there are the same number of steps. The output voltage, however, has been shifted from a range of, for example, 0V to 4.096V ($G = +2$) to a range of -2.048V to $+2.048\text{V}$.

Keep in mind that when using the DAC as a four-quadrant multiplier, the scale is skewed. Negative full scale is $-V_{REFIN}$, while positive full scale is $+V_{REFIN} - 1\text{LSB}$.

+5V, Low-Power, Voltage-Output, Serial 12-Bit DACs

MAX531/MAX538/MAX539



Figure 4. Microwire Connection



Figure 5. SPI/QSPI Connection



Figure 6. Unipolar Configuration (0V to +2.048V Output)



Figure 7. Unipolar Configuration (0V to +4.096V Output)

Table 1. Unipolar Binary Code Table (0V to VREFIN Output), Gain = +1

INPUT	OUTPUT
1111 1111 1111	$(V_{REFIN}) \frac{4095}{4096}$
1000 0000 0001	$(V_{REFIN}) \frac{2049}{4096}$
1000 0000 0000	$(V_{REFIN}) \frac{2048}{4096} = +V_{REFIN} / 2$
0111 1111 1111	$(V_{REFIN}) \frac{2047}{4096}$
0000 0000 0001	$(V_{REFIN}) \frac{1}{4096}$
0000 0000 0000	0V

Table 2. Unipolar Binary Code Table (0V to 2VREFIN Output), Gain = +2

INPUT	OUTPUT
1111 1111 1111	$+2 (V_{REFIN}) \frac{4095}{4096}$
1000 0000 0001	$+2 (V_{REFIN}) \frac{2049}{4096}$
1000 0000 0000	$+2 (V_{REFIN}) \frac{2048}{4096} = +V_{REFIN}$
0111 1111 1111	$+2 (V_{REFIN}) \frac{2047}{4096}$
0000 0000 0001	$+2 (V_{REFIN}) \frac{1}{4096}$
0000 0000 0000	0V

+5V, Low-Power, Voltage-Output, Serial 12-Bit DACs

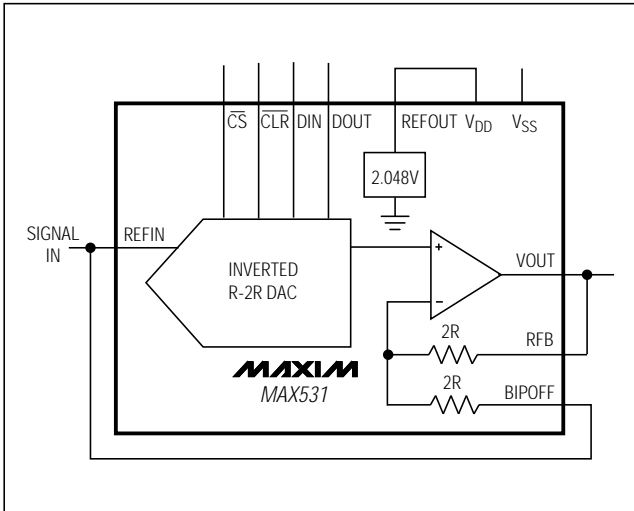

Figure 9. MAX531 Connected as Four-Quadrant Multiplier. The unused REFOUT is connected to V_{DD}.

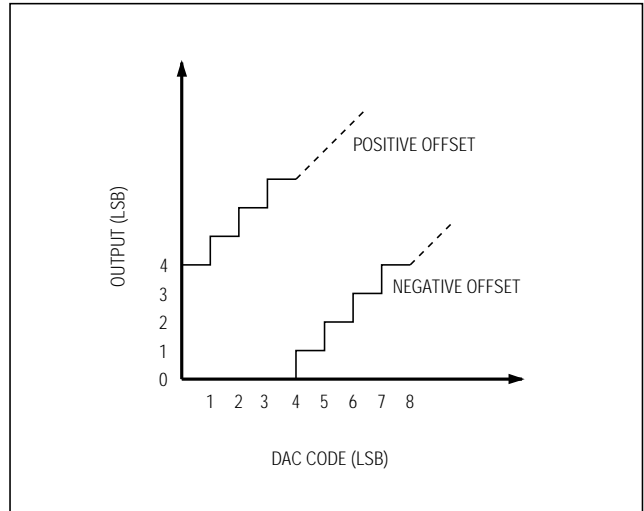

Figure 10. Single-Supply Offset

AC Considerations

Digital Feedthrough

High-speed serial data at any of the digital input or output pins may couple through the DAC package and cause internal stray capacitance to appear at the DAC output as noise, even though \overline{CS} is held high (see *Typical Operating Characteristics*). This digital feedthrough is tested by holding \overline{CS} high, transmitting 555 hex from DIN to DOUT.

Analog Feedthrough

Because of internal stray capacitance, higher frequency analog input signals may couple to the output as shown in the Analog Feedthrough vs. Frequency graph in the *Typical Operating Characteristics*. It is tested by holding \overline{CS} high, setting the DAC code to all 0s, and sweeping REF_{IN}.

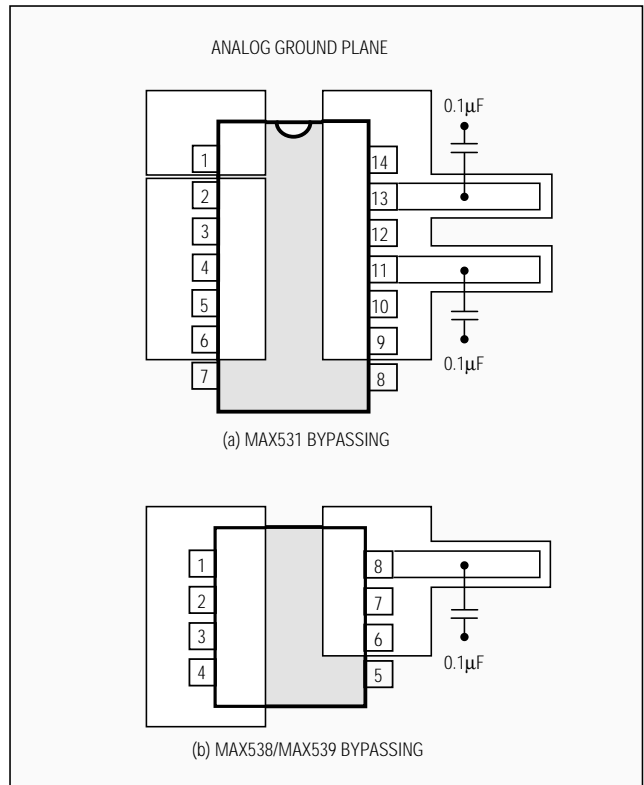

Figure 11. Power-Supply Bypassing

+5V, Low-Power, Voltage-Output, Serial 12-Bit DACs

Ordering Information (continued)

PART	TEMP. RANGE	PIN-PACKAGE	ERROR (LSB)
MAX531AEPD	-40°C to +85°C	14 Plastic DIP	±1/2
MAX531BEPD	-40°C to +85°C	14 Plastic DIP	±1
MAX531AESD	-40°C to +85°C	14 SO	±1/2
MAX531BESD	-40°C to +85°C	14 SO	±1
MAX538 ACPA	0°C to +70°C	8 Plastic DIP	±1/2
MAX538BCPA	0°C to +70°C	8 Plastic DIP	±1
MAX538ACSA	0°C to +70°C	8 SO	±1/2
MAX538BCSA	0°C to +70°C	8 SO	±1
MAX538BC/D	0°C to +70°C	Dice*	±1
MAX538AEPA	-40°C to +85°C	8 Plastic DIP	±1/2
MAX538BEPA	-40°C to +85°C	8 Plastic DIP	±1
MAX538AESA	-40°C to +85°C	8 SO	±1/2
MAX538BESA	-40°C to +85°C	8 SO	±1
MAX539 ACPA	0°C to +70°C	8 Plastic DIP	±1/2
MAX539BCPA	0°C to +70°C	8 Plastic DIP	±1
MAX539ACSA	0°C to +70°C	8 SO	±1/2
MAX539BCSA	0°C to +70°C	8 SO	±1
MAX539BC/D	0°C to +70°C	Dice*	±1
MAX539AEPA	-40°C to +85°C	8 Plastic DIP	±1/2
MAX539BEPA	-40°C to +85°C	8 Plastic DIP	±1
MAX539AESA	-40°C to +85°C	8 SO	±1/2
MAX539BESA	-40°C to +85°C	8 SO	±1

*Dice are specified at T_A = +25°C only.

Pin Configurations (continued)



Chip Topography

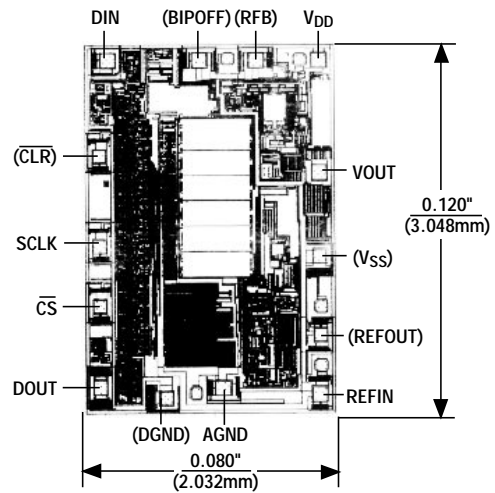

() ARE FOR MAX531 ONLY.

TRANSISTOR COUNT: 922
SUBSTRATE CONNECTED TO V_{DD}

+5V, Low-Power, Voltage-Output, Serial 12-Bit DACs

Package Information

MAX531/MAX538/MAX539

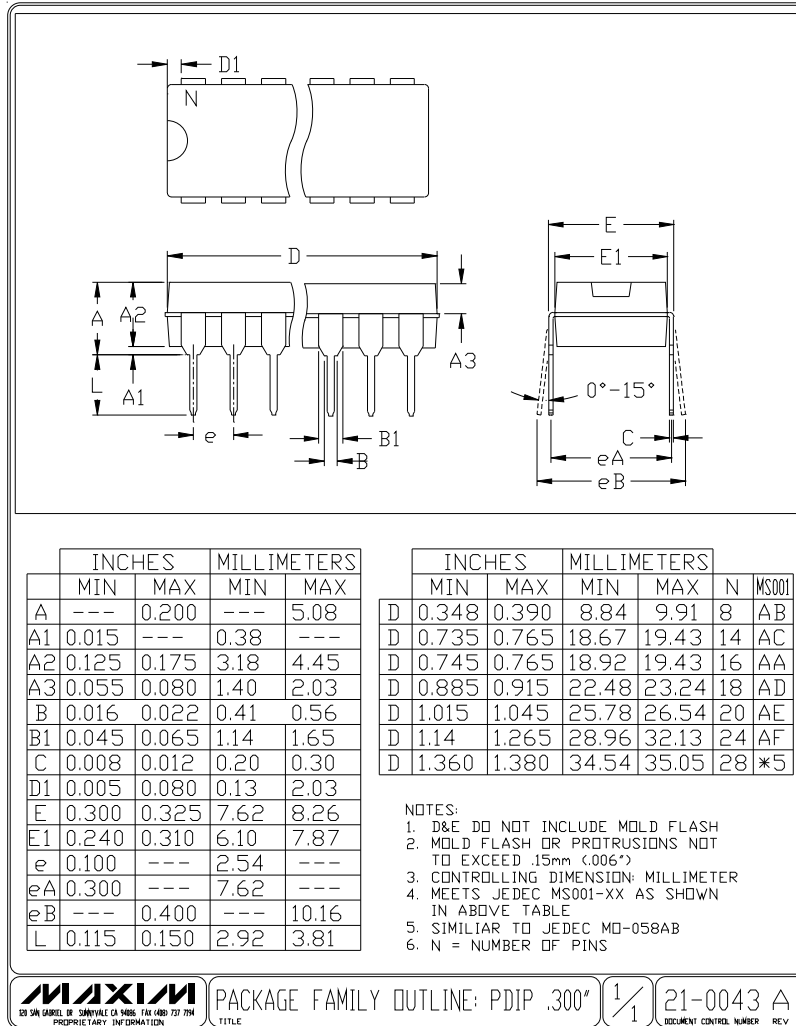

+5V, Low-Power, Voltage-Output, Serial 12-Bit DACs

Package Information (continued)

	INCHES		MILLIMETERS	
	MIN	MAX	MIN	MAX
A	0.053	0.069	1.35	1.75
A1	0.004	0.010	0.10	0.25
B	0.014	0.019	0.35	0.49
C	0.007	0.010	0.19	0.25
e	0.050		1.27	
E	0.150	0.157	3.80	4.00
H	0.228	0.244	5.80	6.20
h	0.010	0.020	0.25	0.50
L	0.016	0.050	0.40	1.27

	INCHES		MILLIMETERS		N	MS012
	MIN	MAX	MIN	MAX		
D	0.189	0.197	4.80	5.00	8	A
D	0.337	0.344	8.55	8.75	14	B
D	0.386	0.394	9.80	10.00	16	C

NOTES:
 1. D&E DO NOT INCLUDE MOLD FLASH
 2. MOLD FLASH OR PROTRUSIONS NOT TO EXCEED .15mm (.006")
 3. LEADS TO BE COPLANAR WITHIN .102mm (.004")
 4. CONTROLLING DIMENSION: MILLIMETER
 5. MEETS JEDEC MS012-XX AS SHOWN IN ABOVE TABLE
 6. N = NUMBER OF PINS

MAXIM
120 SAN GABRIEL DRIVE, SUNNYVALE, CA 94086-1774 FAX (408) 737-7700
 PROPRIETARY INFORMATION

PACKAGE FAMILY OUTLINE: SOIC .150" $\frac{1}{1}$ 21-0041 A
TITLE DOCUMENT CONTROL NUMBER REV

Maxim cannot assume responsibility for use of any circuitry other than circuitry entirely embodied in a Maxim product. No circuit patent licenses are implied. Maxim reserves the right to change the circuitry and specifications without notice at any time.

16 Maxim Integrated Products, 120 San Gabriel Drive, Sunnyvale, CA 94086 (408) 737-7600

Looking for pricing, stock, or lifecycle information?

Click below to explore more details on WIN SOURCE:

 [View MAX531BESD+ on WIN SOURCE](#)

 [Maxim Integrated](#) Information

Optimize Your Supply Chain with WIN SOURCE Solutions

-  Global Sourcing Solution
-  Obsolete Management
-  Cost Control Management
-  Shortage Management
-  Alternative Solution
-  Excess Inventory Management