



**THE DATASHEET OF
MAX4039EUB+T**





Low IBIAS, +1.4V/800nA, Rail-to-Rail Op Amps with +1.2V Buffered Reference

General Description

The single MAX4036/MAX4037 and dual MAX4038/MAX4039 operational amplifiers operate from a single +1.4V to +3.6V (without reference) or +1.8V to +3.6V (with reference) supply and consume only 800nA of supply current per amplifier, and 1.1μA for the optional reference. The MAX4036/MAX4038 feature a common-mode input voltage range from 0V to $V_{DD} - 0.4V$ at $V_{DD} = 1.4V$. The MAX4037/MAX4039 feature a 1.232V voltage reference capable of sourcing 100μA and sinking 20μA.

The MAX4036–MAX4039s' rail-to-rail outputs drive 5kΩ loads to within 25mV of the rails. Ultra-low supply current, low operating voltage, and rail-to-rail outputs make the MAX4036–MAX4039 ideal for use in single-cell lithium-ion (Li+), or two-cell NiCd/NiMH/alkaline battery-powered applications.

The MAX4036 is available in an SC70 package, the MAX4037 in a SOT23 package, and the MAX4038/MAX4039 in UCSP™, μMAX®, and TDFN packages.

Applications

Battery-Powered/Solar-Powered Systems
 Portable Medical Instrumentation
 Pagers and Cell Phones
 Micropower Thermostats and Potentiostats
 Electrometer Amplifiers
 Remote Sensor Amplifiers
 Active Badges
 pH Meters

Pin Configurations and Selector Guide appear at end of data sheet.

μMAX is a registered trademark and UCSP is a trademark of Maxim Integrated Products, Inc.

Functional Diagram

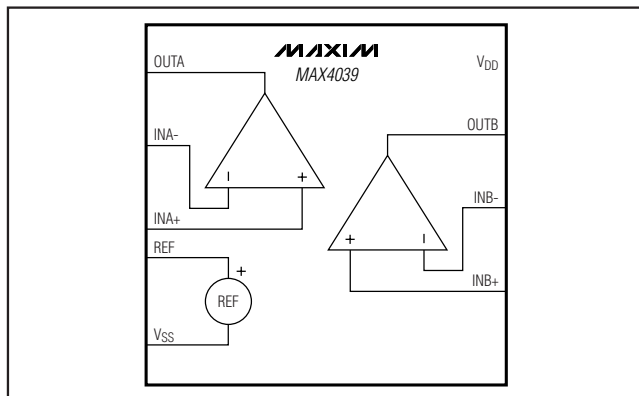

Features

- ◆ Ultra-Low 800nA per Amplifier Supply Current
- ◆ Ultra-Low 1.4V Supply Voltage Operation (1.8V for MAX4037/MAX4039)
- ◆ Rail-to-Rail Outputs Drive 5kΩ and 5000pF Load
- ◆ 1.232V ±0.5%, 120ppm/°C (max) Reference (MAX4037/MAX4039)
- ◆ No External Reference Bypass Capacitor Required
- ◆ No Phase Reversal for Overdriven Inputs
- ◆ Low 1.0pA (typ) Input Bias Current
- ◆ Low 200μV Input Offset Voltage
- ◆ Unity-Gain Stable
- ◆ Available in Tiny UCSP, SC70, SOT23, TDFN, and μMAX Packages
- ◆ Available in -40°C to +125°C Temperature Range (MAX4036A/MAX4038A)

Ordering Information

| PART | TEMP RANGE | PIN-PACKAGE | TOP MARK |
|---------------|-----------------|-------------|----------|
| MAX4036EXK-T | -40°C to +85°C | 5 SC70 | AFR |
| MAX4036AAXK+T | -40°C to +125°C | 5 SC70 | ASN |
| MAX4037EUT-T | -40°C to +85°C | 6 SOT23 | ABRX |
| MAX4038ETA-T | -40°C to +85°C | 8 TDFN-EP* | AGO |
| MAX4038EUA | -40°C to +85°C | 8 μMAX | — |
| MAX4038EBL-T | -40°C to +85°C | 9 UCSP | AEG |
| MAX4038AAUA | -40°C to +125°C | 8 μMAX | — |

+Denotes a lead(Pb)-free/RoHS-compliant package.

-Denotes a package containing lead.

*EP = Exposed pad.

Ordering Information continued at end of data sheet.

Typical Operating Circuit

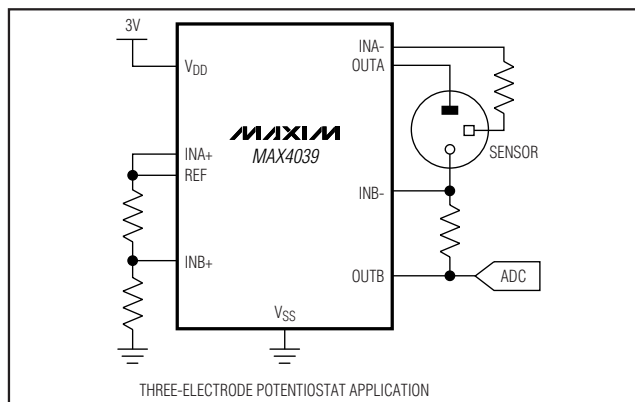

THREE-ELECTRODE POTENTIOSTAT APPLICATION



Low IBIAS, +1.4V/800nA, Rail-to-Rail Op Amps with +1.2V Buffered Reference

ABSOLUTE MAXIMUM RATINGS

| | | | |
|--|--|--|-----------------|
| V _{DD} to V _{SS} | -0.3V to +4.0V | 9-Bump UCSP (derate 5.2mW/°C above +70°C)..... | 412mW |
| INA+, INB+, INA-, INB-, IN+, IN-, OUTA, OUTB, OUT, REF | (V _{SS} - 0.3V) to (V _{DD} + 0.3V) | 10-Pin μMAX (derate 5.6mW/°C above +70°C)..... | 444mW |
| OUTA, OUTB, OUT, REF Shorted to V _{SS} or V _{DD} | Continuous | 10-Pin TDFN (derate 24.4mW/°C above +70°C) | 1951mW |
| Maximum Continuous Power Dissipation (T _A = +70°C) | | Operating Temperature Range | |
| 5-Pin SC70 (derate 3.1mW/°C above +70°C)..... | 247mW | MAX403_E_..... | -40°C to +85°C |
| 6-Pin SOT23 (derate 8.7mW/°C above +70°C)..... | 696mW | MAX403_A_..... | -40°C to +125°C |
| 8-Pin μMAX (derate 4.5mW/°C above +70°C)..... | 362mW | Junction Temperature | +150°C |
| 8-Pin TDFN (derate 24.4mW/°C above +70°C) | 1951mW | Storage Temperature Range | -65°C to +150°C |
| | | Lead Temperature (soldering, 10s)..... | +300°C |

Stresses beyond those listed under "Absolute Maximum Ratings" may cause permanent damage to the device. These are stress ratings only, and functional operation of the device at these or any other conditions beyond those indicated in the operational sections of the specifications is not implied. Exposure to absolute maximum rating conditions for extended periods may affect device reliability.

ELECTRICAL CHARACTERISTICS

(V_{DD} = +3V, V_{SS} = V_{CM} = 0V, V_{OUT_} = V_{DD}/2, R_L to V_{DD}/2, C_L = 15pF, T_A = +25°C, unless otherwise specified.)

| PARAMETER | SYMBOL | CONDITIONS | | MIN | TYP | MAX | UNITS |
|----------------------|------------------------|---|------------------------|-----|-----|-----|-------|
| Supply Voltage Range | V _{DD} | MAX4036/MAX4038, guaranteed by PSRR tests | | 1.4 | | 3.6 | V |
| | | MAX4037/MAX4039, guaranteed by PSRR and line regulation tests | | 1.8 | | 3.6 | |
| Supply Current | I _{DD} | MAX4036 | V _{DD} = 1.4V | | 0.8 | 1.2 | μA |
| | | | V _{DD} = 3.6V | | 0.9 | 1.3 | |
| | | MAX4037 | V _{DD} = 1.8V | | 1.9 | 2.4 | |
| | | | V _{DD} = 3.6V | | 2.0 | 2.5 | |
| | | MAX4038 | V _{DD} = 1.4V | | 1.7 | 2.3 | |
| | | | V _{DD} = 3.6V | | 1.9 | 2.5 | |
| MAX4039 | V _{DD} = 1.8V | | 2.8 | 4.0 | | | |
| | V _{DD} = 3.6V | | 3.0 | 4.1 | | | |

OPERATIONAL AMPLIFIERS

| | | | | | | |
|---------------------------------|-----------------|---|---|-----------------|-----------------------|----|
| Input Offset Voltage | V _{OS} | | | ±0.2 | ±2.0 | mV |
| Input Bias Current | I _B | (Note 1) | | ±1.0 | ±10 | pA |
| Input Offset Current | I _{OS} | (Note 1) | | ±0.3 | ±20 | pA |
| Input Common-Mode Voltage Range | V _{CM} | Guaranteed by CMRR test | V _{DD} = 1.4V (MAX4036/MAX4038 only) | V _{SS} | V _{DD} - 0.4 | V |
| | | | V _{DD} = 1.8V | V _{SS} | V _{DD} - 0.3 | |
| | | | V _{DD} = 3.3V | V _{SS} | V _{DD} - 0.2 | |
| Common-Mode Rejection Ratio | CMRR | V _{DD} = 1.4V, V _{SS} ≤ V _{CM} ≤ (V _{DD} - 0.4V) (MAX4036/MAX4038 only) | | 50 | 70 | dB |
| | | V _{DD} = 1.8V, V _{SS} ≤ V _{CM} ≤ (V _{DD} - 0.3V) | | 50 | 70 | |
| | | V _{DD} = 3.3V, V _{SS} ≤ V _{CM} ≤ (V _{DD} - 0.2V) | | 56 | 76 | |
| Power-Supply Rejection Ratio | PSRR | 1.4V ≤ V _{DD} ≤ 3.6V (MAX4036/MAX4038 only) | | 62 | 82 | dB |
| | | 1.8V ≤ V _{DD} ≤ 3.6V | | 62 | 84 | |

Low IBIAS, +1.4V/800nA, Rail-to-Rail Op Amps with +1.2V Buffered Reference

MAX4036-MAX4039

ELECTRICAL CHARACTERISTICS (continued)

($V_{DD} = +3V$, $V_{SS} = V_{CM} = 0V$, $V_{OUT_} = V_{DD}/2$, R_L to $V_{DD}/2$, $C_L = 15pF$, $T_A = +25^\circ C$, unless otherwise specified.)

| PARAMETER | SYMBOL | CONDITIONS | MIN | TYP | MAX | UNITS |
|------------------------------------|----------------------------------|---|-------|----------|--------|-------------------|
| Large-Signal Voltage Gain | A_{VOL} | $R_L = 100k\Omega$, $50mV \leq V_{OUT} \leq (V_{DD} - 50mV)$ | 80 | 108 | | dB |
| | | $R_L = 5k\Omega$, $150mV \leq V_{OUT} \leq (V_{DD} - 150mV)$ | 78 | 105 | | |
| Output Voltage Swing High | $V_{DD} - V_{OH}$ | $R_L = 100k\Omega$ | | 2 | 5 | mV |
| | | $R_L = 5k\Omega$ | | 25 | 50 | |
| Output Voltage Swing Low | $V_{OL} - V_{SS}$ | $R_L = 100k\Omega$ | | 2 | 5 | mV |
| | | $R_L = 5k\Omega$ | | 25 | 50 | |
| Output Short-Circuit Current | I_{SCO} | To V_{DD} or V_{SS} | | ± 13 | | mA |
| Gain-Bandwidth Product | GBW | | | 4 | | kHz |
| Phase Margin | θ_M | | | 90 | | Degrees |
| Slew Rate | SR | | | 4 | | V/ms |
| Power-On Time | t_{ON} | (Note 3) | | 0.25 | | ms |
| Input Noise-Voltage Density | e_n | $f = 1kHz$ | | 500 | | nV/ \sqrt{Hz} |
| Capacitive-Load Stability | C_{LOAD} | $A_{VCL} = 1V/V$, no sustained oscillations | | 5000 | | pF |
| REFERENCE (MAX4037/MAX4039) | | | | | | |
| Reference Voltage | V_{REF} | | 1.226 | 1.232 | 1.238 | V |
| Line Regulation | $\Delta V_{REF}/\Delta V_{DD}$ | $V_{DD} = +1.8V$ to $+3.6V$ | | | 0.3 | %/V |
| Load Regulation | $\Delta V_{REF}/\Delta I_{LOAD}$ | $0 \leq I_{LOAD} \leq 100\mu A$, sourcing | | | 0.0015 | %/μA |
| | | $-20\mu A \leq I_{LOAD} \leq 0$, sinking | | | 0.0075 | |
| Reference Output Voltage Noise | e_n | 0.1Hz to 10Hz | | 60 | | μV _{P-P} |
| Output Short-Circuit Current | I_{SCR} | Short to V_{DD} | | 0.25 | | mA |
| | | Short to V_{SS} | | 1.9 | | |
| Capacitive-Load Stability Range | C_{LOAD} | (Note 1) | 0 | | 250 | pF |

ELECTRICAL CHARACTERISTICS

($V_{DD} = +3V$, $V_{SS} = V_{CM} = 0V$, $V_{OUT_} = V_{DD}/2$, R_L to $V_{DD}/2$, $C_L = 15pF$, $T_A = T_{MIN}$ to T_{MAX} , unless otherwise specified.) (Note 2)

| PARAMETER | SYMBOL | CONDITIONS | MIN | TYP | MAX | UNITS |
|----------------------|----------|---|-----------------|-----|-----|-------|
| Supply Voltage Range | V_{DD} | MAX4036/MAX4038, guaranteed by PSRR test | 1.4 | | 3.6 | V |
| | | MAX4037/MAX4039, guaranteed by PSRR and line regulation tests | 1.8 | | 3.6 | |
| Supply Current | I_{DD} | MAX4036 | $V_{DD} = 1.4V$ | | 1.7 | μA |
| | | | $V_{DD} = 3.6V$ | | 1.8 | |
| | | MAX4036A | $V_{DD} = 1.4V$ | | 2.0 | |
| | | | $V_{DD} = 3.6V$ | | 2.1 | |
| | | MAX4037 | $V_{DD} = 1.8V$ | | 3.1 | |
| | | | $V_{DD} = 3.6V$ | | 3.2 | |

Low IBIAS, +1.4V/800nA, Rail-to-Rail Op Amps with +1.2V Buffered Reference

ELECTRICAL CHARACTERISTICS (continued)

($V_{DD} = +3V$, $V_{SS} = V_{CM} = 0V$, $V_{OUT_} = V_{DD}/2$, R_L to $V_{DD}/2$, $C_L = 15pF$, $T_A = T_{MIN}$ to T_{MAX} , unless otherwise specified.) (Note 2)

| PARAMETER | SYMBOL | CONDITIONS | | MIN | TYP | MAX | UNITS | |
|--|--|---|---|----------|---------|----------------|-------------------|--|
| Supply Current | I_{DD} | MAX4038 | $V_{DD} = 1.4V$ | | | 2.9 | μA | |
| | | | $V_{DD} = 3.6V$ | | | 3.2 | | |
| | | MAX4038A | $V_{DD} = 1.4V$ | | | 3.4 | | |
| | | | $V_{DD} = 3.6V$ | | | 3.7 | | |
| | | MAX4039 | $V_{DD} = 1.8V$ | | | 5.2 | | |
| | | | $V_{DD} = 3.6V$ | | | 5.3 | | |
| OPERATIONAL AMPLIFIERS | | | | | | | | |
| Input Offset Voltage | V_{OS} | | | | | ± 8 | mV | |
| Input Offset Voltage Temperature Coefficient | TCV_{OS} | | | | ± 1 | | $\mu V/^{\circ}C$ | |
| Input Bias Current | I_B | | | | | ± 100 | pA | |
| Input Offset Current | I_{OS} | | | | | ± 200 | pA | |
| Input Common-Mode Voltage Range | V_{CM} | Guaranteed by CMRR test | $V_{DD} = 1.4V$ (MAX4036/MAX4038 only) | V_{SS} | | $V_{DD} - 0.4$ | V | |
| | | | $V_{DD} = 1.8V$ | V_{SS} | | $V_{DD} - 0.4$ | | |
| | | | $V_{DD} = 3.3V$ | V_{SS} | | $V_{DD} - 0.2$ | | |
| Common-Mode Rejection Ratio | CMRR | $V_{DD} = 1.4V$, $V_{SS} \leq V_{CM} \leq (V_{DD} - 0.5V)$ (MAX4036/MAX4038 only) | | 44 | | | dB | |
| | | $V_{DD} = 1.8V$, $V_{SS} \leq V_{CM} \leq (V_{DD} - 0.4V)$ | | 50 | | | | |
| | | $V_{DD} = 3.3V$, $V_{SS} \leq V_{CM} \leq (V_{DD} - 0.3V)$ | | 52 | | | | |
| Power-Supply Rejection Ratio | PSRR | $1.4V \leq V_{DD} \leq 3.6V$ (MAX4036/MAX4038 only) | | 60 | | | dB | |
| | | $1.8V \leq V_{DD} \leq 3.6V$ | | 60 | | | | |
| Large-Signal Voltage Gain | A_{VOL} | $R_L = 100k\Omega$, $50mV \leq V_{OUT} \leq (V_{DD} - 50mV)$ | | 75 | | | dB | |
| | | $R_L = 5k\Omega$, $150mV \leq V_{OUT} \leq (V_{DD} - 150mV)$ | | 73 | | | | |
| Output Voltage Swing High | $V_{DD} - V_{OH}$ | $R_L = 100k\Omega$ | | | | 10 | mV | |
| | | $R_L = 5k\Omega$ | | | | 100 | | |
| Output Voltage Swing Low | $V_{OL} - V_{SS}$ | $R_L = 100k\Omega$ | | | | 10 | mV | |
| | | $R_L = 5k\Omega$ | | | | 100 | | |
| REFERENCE (MAX4037/MAX4039) | | | | | | | | |
| Reference Voltage Temperature Coefficient | TCV_{REF} | (Note 1) | MAX4037EUT-T, MAX4039ETB, MAX4039EUB | | 25 | 120 | ppm/ $^{\circ}C$ | |
| | | | MAX4039EBL-T | | 35 | 200 | | |
| Line Regulation | $\frac{\Delta V_{REF}}{\Delta V_{DD}}$ | $V_{DD} = 1.8V$ to $3.6V$ | | | | 0.6 | %/V | |
| Load Regulation | $\frac{\Delta V_{REF}}{\Delta I_{LOAD}}$ | $0 \leq I_{LOAD} \leq 100\mu A$, sourcing | | | | 0.003 | %/ μA | |
| | | $-20\mu A \leq I_{LOAD} \leq 0$, sinking | | | | 0.015 | | |
| Capacitive-Load Stability Range | C_{LOAD} | (Note 1) | | 0 | | 250 | pF | |

Note 1: Guaranteed by design.

Note 2: All devices are production tested at $T_A = +25^{\circ}C$. All temperature limits are guaranteed by design.

Note 3: Output settles within 1% of final value.

Low IBIAS, +1.4V/800nA, Rail-to-Rail Op Amps with +1.2V Buffered Reference

Typical Operating Characteristics

($V_{DD} = 3V$, $V_{SS} = V_{CM} = 0V$, R_L to $V_{DD}/2$, $T_A = +25^\circ C$, unless otherwise noted.)

MAX4036-MAX4039

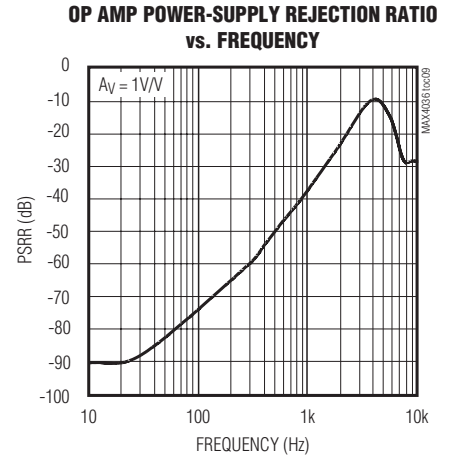
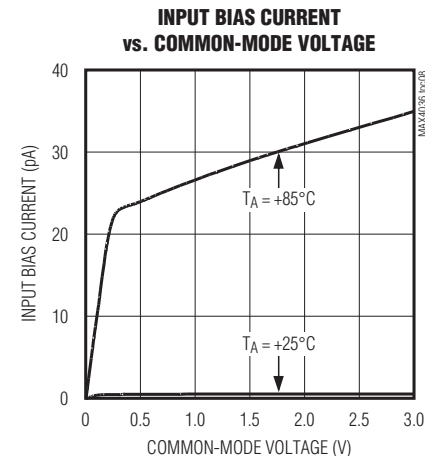
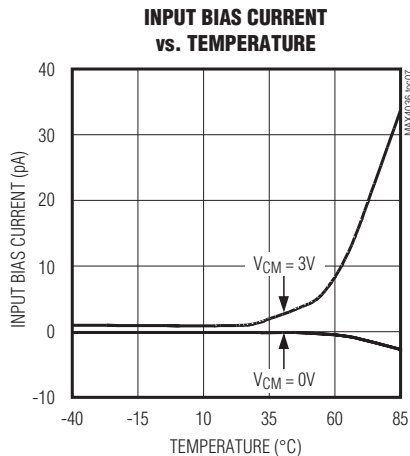
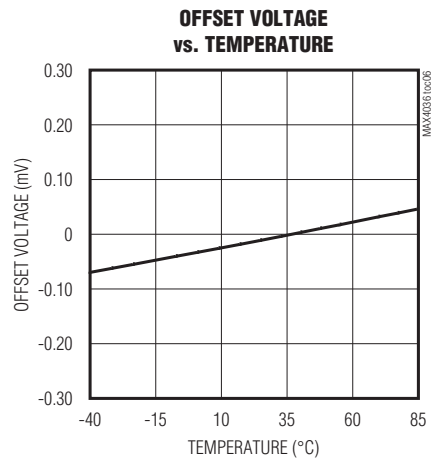
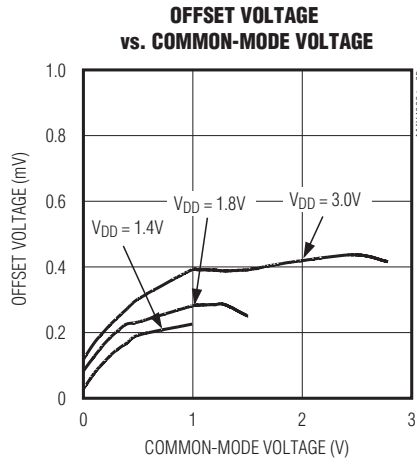
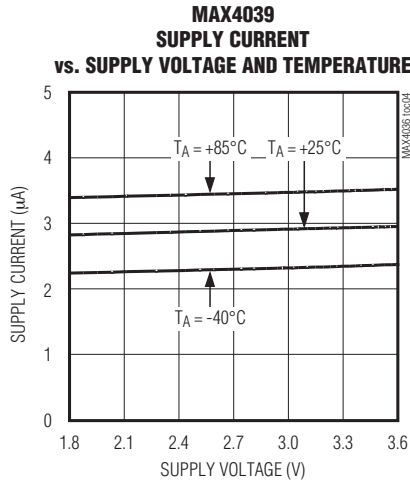
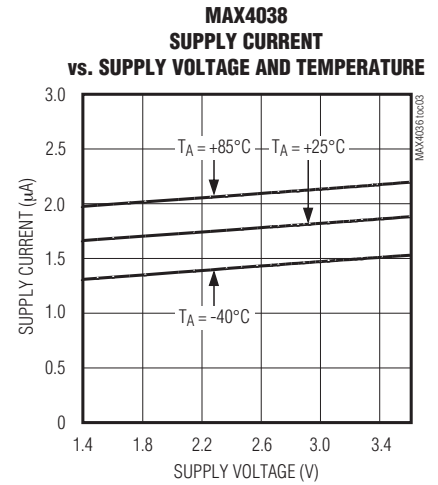
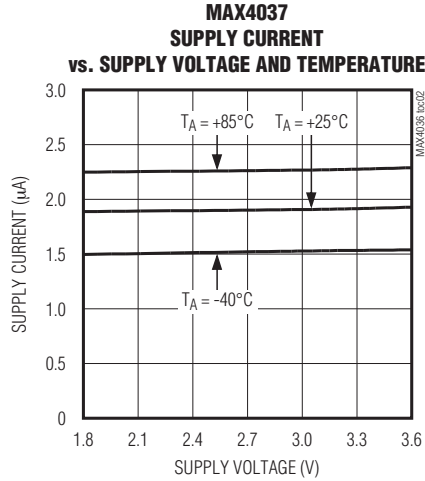
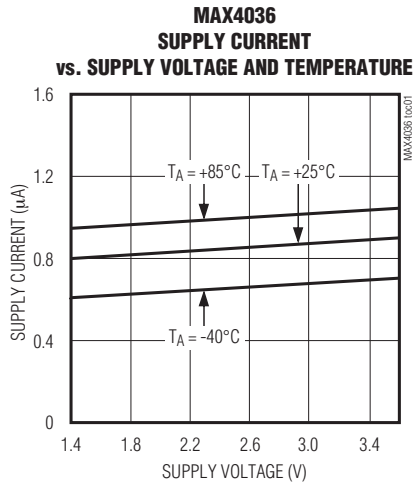

Low IBIAS, +1.4V/800nA, Rail-to-Rail Op Amps with +1.2V Buffered Reference

Typical Operating Characteristics (continued)

($V_{DD} = 3V$, $V_{SS} = V_{CM} = 0V$, R_L to $V_{DD}/2$, $T_A = +25^\circ C$, unless otherwise noted.)

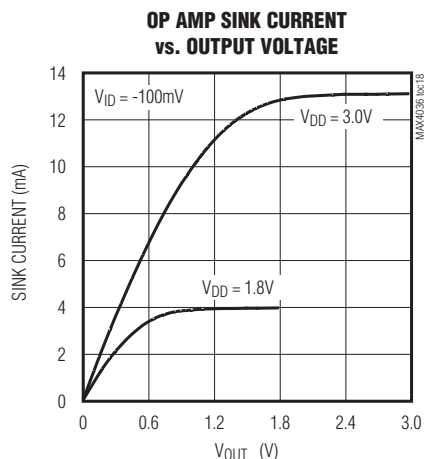
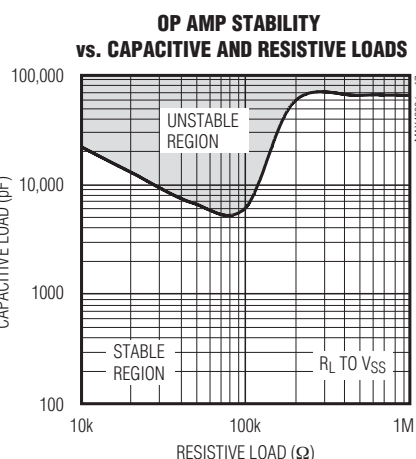
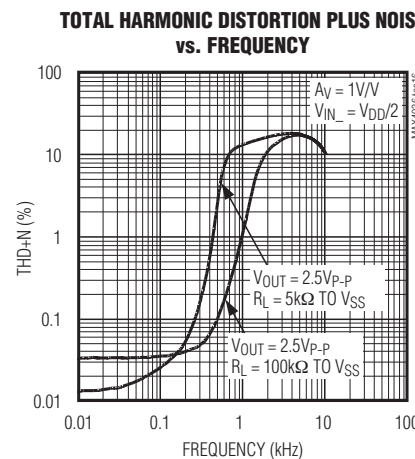
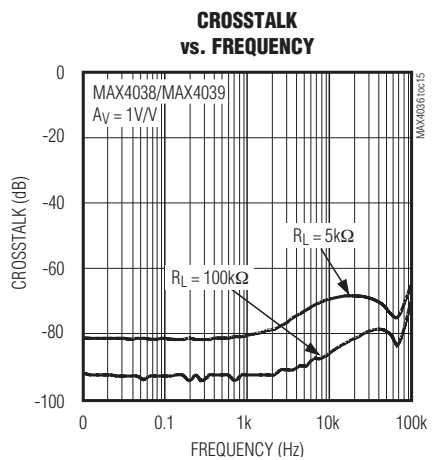
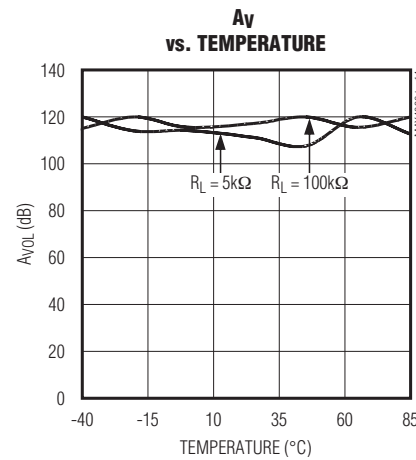
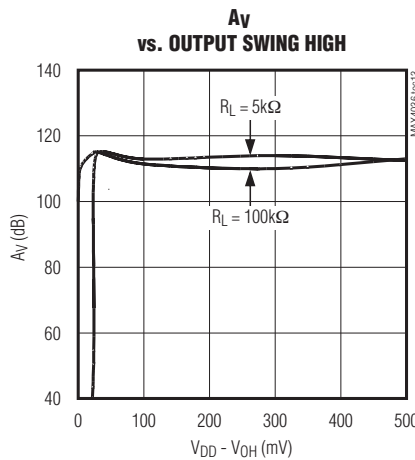
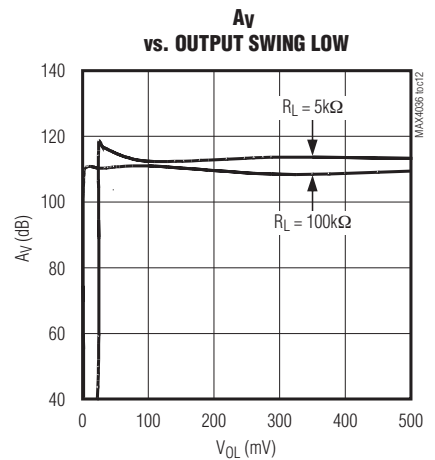
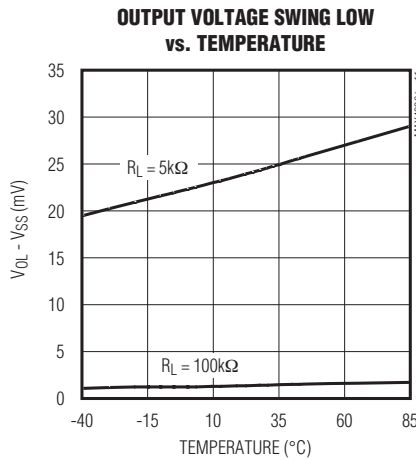
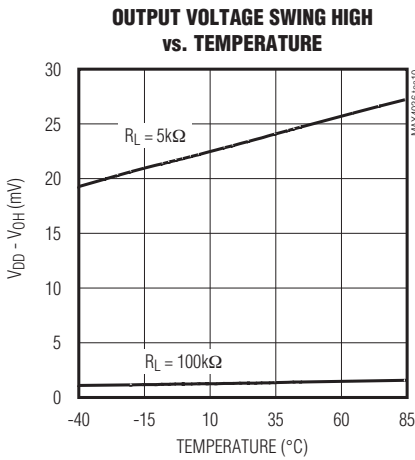

Low IBIAS, +1.4V/800nA, Rail-to-Rail Op Amps with +1.2V Buffered Reference

MAX4036-MAX4039

Typical Operating Characteristics (continued)

($V_{DD} = 3V$, $V_{SS} = V_{CM} = 0V$, R_L to $V_{DD}/2$, $T_A = +25^\circ C$, unless otherwise noted.)

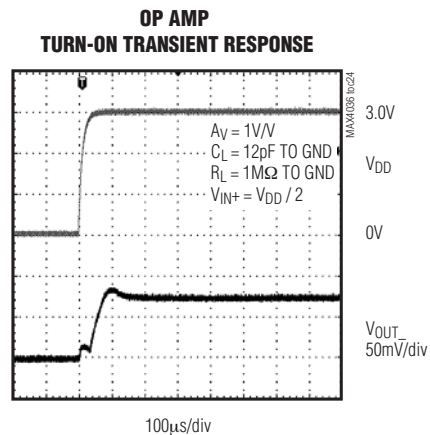
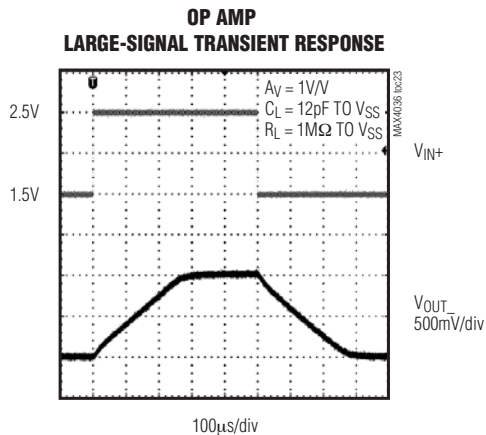
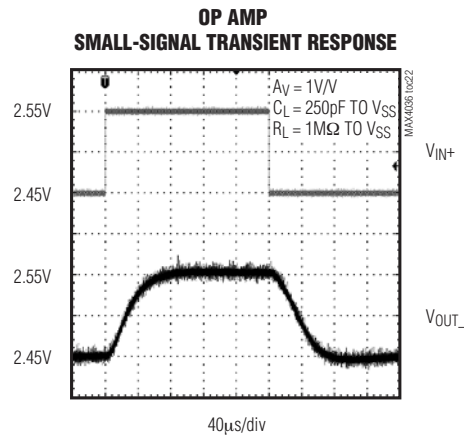
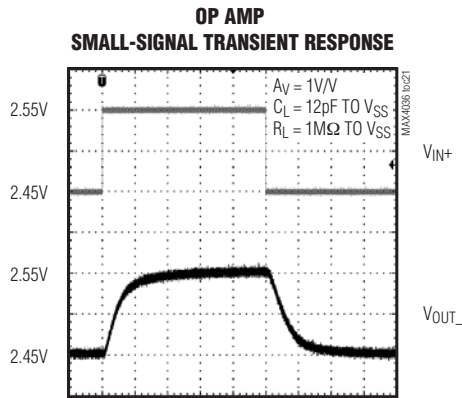
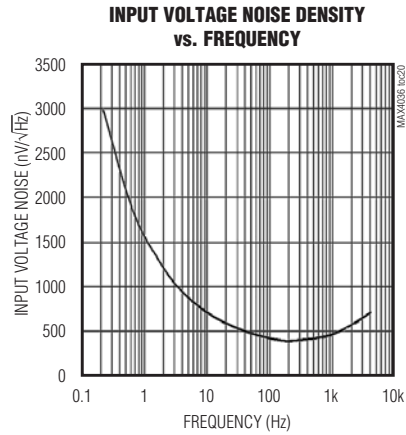
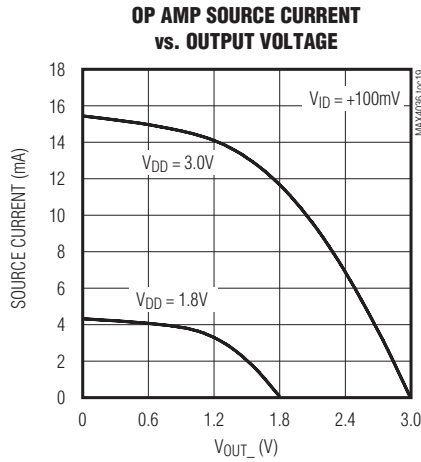

Low IBIAS, +1.4V/800nA, Rail-to-Rail Op Amps with +1.2V Buffered Reference

Typical Operating Characteristics (continued)

($V_{DD} = 3V$, $V_{SS} = V_{CM} = 0V$, R_L to $V_{DD}/2$, $T_A = +25^\circ C$, unless otherwise noted.)

GAIN AND PHASE vs. FREQUENCY

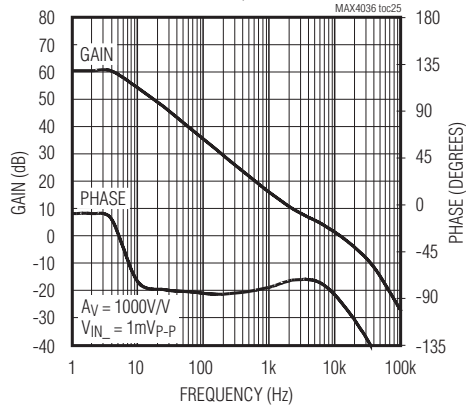

LARGE-SIGNAL GAIN vs. FREQUENCY

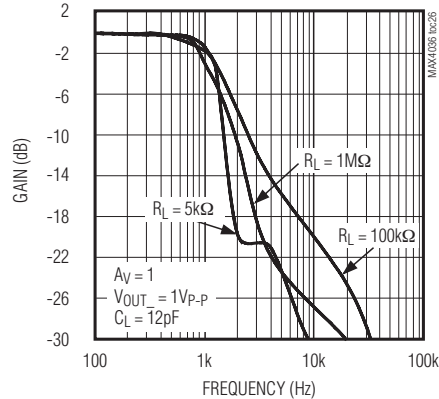

REFERENCE VOLTAGE vs. TEMPERATURE

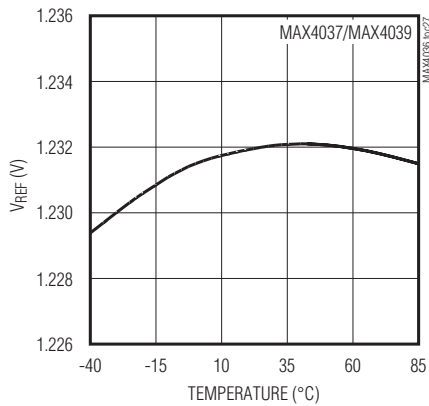

REFERENCE VOLTAGE CHANGE vs. TIME

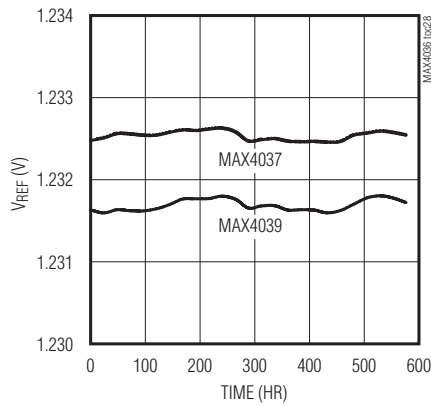

REFERENCE VOLTAGE CHANGE vs. LOAD CURRENT

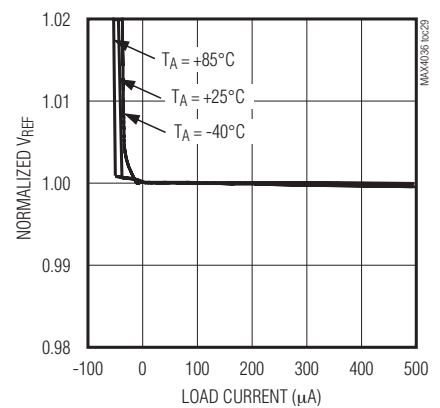

REFERENCE VOLTAGE CHANGE vs. SUPPLY VOLTAGE

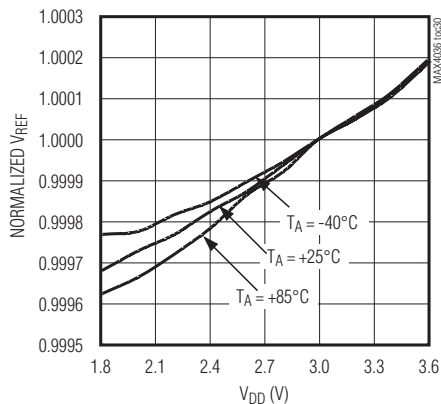

REFERENCE LINE-TRANSIENT RESPONSE

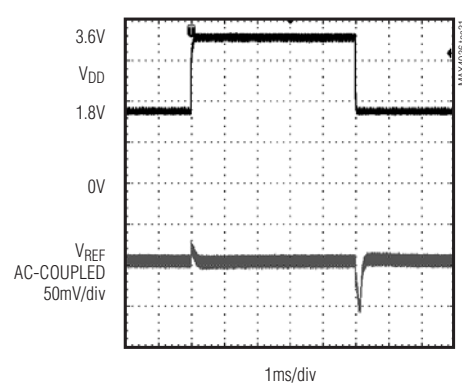

Low IBIAS, +1.4V/800nA, Rail-to-Rail Op Amps with +1.2V Buffered Reference

Typical Operating Characteristics (continued)

($V_{DD} = 3V$, $V_{SS} = V_{CM} = 0V$, R_L to $V_{DD}/2$, $T_A = +25^\circ C$, unless otherwise noted.)

MAX4036-MAX4039

REFERENCE LOAD-TRANSIENT RESPONSE
(SINKING CURRENT)

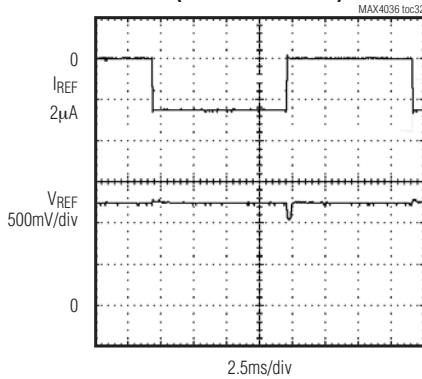

REFERENCE LOAD-TRANSIENT RESPONSE
(SINKING CURRENT)

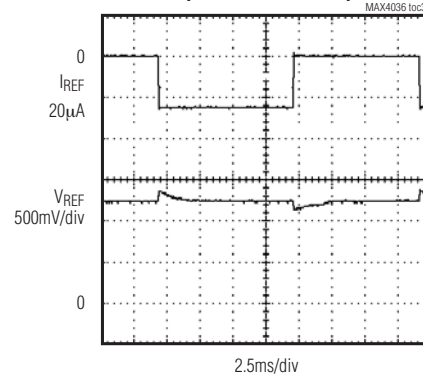

REFERENCE LOAD-TRANSIENT RESPONSE
(SOURCING CURRENT)

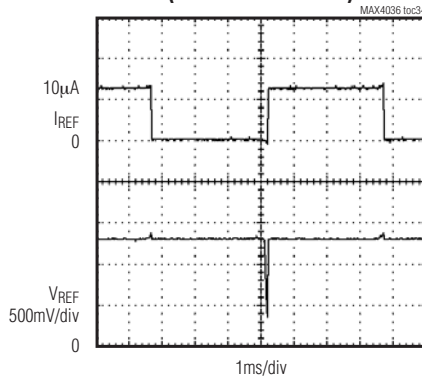

REFERENCE LOAD-TRANSIENT RESPONSE
(SOURCING CURRENT)

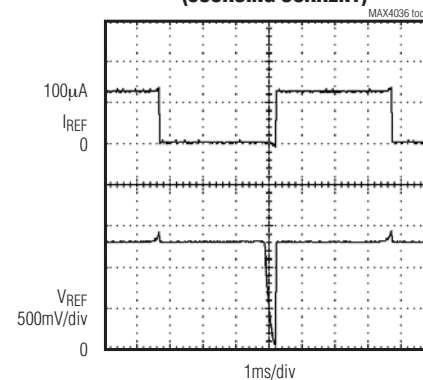

REFERENCE TURN-ON
TRANSIENT RESPONSE

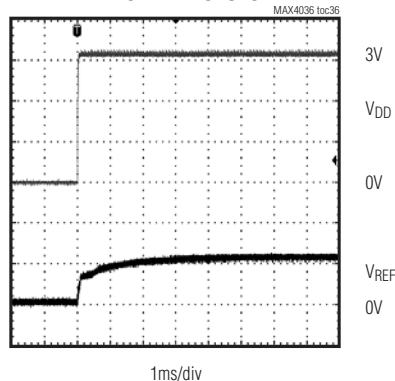

0.1Hz TO 10Hz REFERENCE NOISE

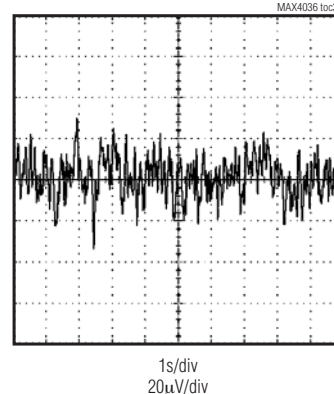

Low IBIAS, +1.4V/800nA, Rail-to-Rail Op Amps with +1.2V Buffered Reference

| | | PIN | | | | NAME | FUNCTION |
|----------------------|---------|----------------------|------|---------------|------|-------------------|---|
| MAX4036/ MAX4036A | MAX4037 | MAX4038/ MAX4038A | | MAX4039 | | | |
| | | μ MAX*/TDFN | UCSP | μ MAX/TDF | UCSP | | |
| 1 | 3 | — | — | — | — | IN+ | Noninverting Amplifier Input |
| 2 | 2 | 4 | A2 | 5 | A2 | V _{SS} | Negative Power-Supply Voltage |
| 3 | 4 | — | — | — | — | IN- | Inverting Amplifier Input |
| 4 | 1 | — | — | — | — | OUT | Amplifier Output |
| 5 | 6 | 8 | C2 | 10 | C2 | V _{DD} | Positive Power-Supply Voltage |
| — | 5 | — | — | 6 | B2 | REF | Reference Voltage Output |
| — | — | 1 | C1 | 1 | C1 | OUTA | Amplifier Output (Channel A) |
| — | — | 2 | B1 | 2 | B1 | INA- | Inverting Amplifier Input (Channel A) |
| — | — | 3 | A1 | 3 | A1 | INA+ | Noninverting Amplifier Input (Channel A) |
| — | — | 5 | A3 | 7 | A3 | INB+ | Noninverting Amplifier Input (Channel B) |
| — | — | 6 | B3 | 8 | B3 | INB- | Inverting Amplifier Input (Channel B) |
| — | — | 7 | C3 | 9 | C3 | OUTB | Amplifier Output (Channel B) |
| — | — | — | B2 | 4 | — | N.C. | No Connection. Not internally connected. |
| — | — | — | — | — | — | EP (TDFN only) | Exposed Paddle. Solder EP to V _{SS} or leave unconnected (TDFN packages only). |

*Both MAX4038/MAX4038A available in μ MAX package only.

Detailed Description

The MAX4036–MAX4039 consume an ultra-low supply current and have rail-to-rail output stages specifically designed for low-voltage operation. The input common-mode voltage range extends from V_{DD} - 0.4V to V_{SS}, although full rail-to-rail input range is possible with degraded performance when operating from a supply voltage above 3.0V. The input offset voltage is typically 200 μ V. Low-operating supply voltage, low supply current, and rail-to-rail outputs make the MAX4036–MAX4039 an excellent choice for precision or general-purpose low-voltage, battery-powered systems.

Rail-to-Rail Outputs

The MAX4036–MAX4039 output stages can drive a 5k Ω load and still swing to within 40mV of the rails. Figure 1 shows the output voltage swing of the MAX4036–MAX4039 configured as a unity-gain buffer, powered from a single 2.4V supply. The output for this setup typically swings from 5mV to V_{DD} - 5mV with a 100k Ω load.

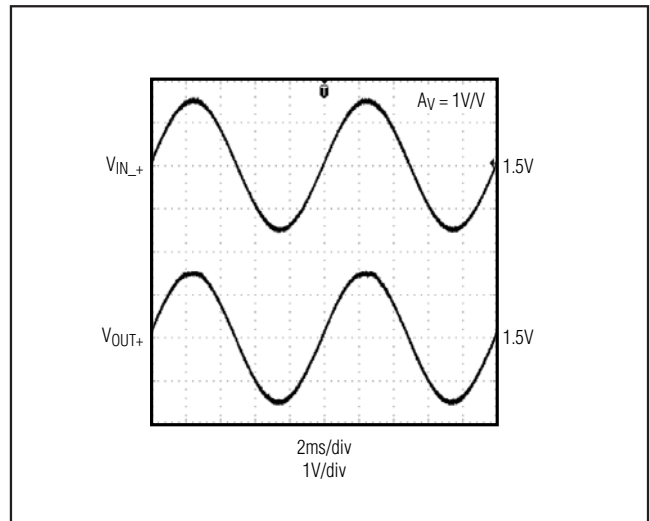

Figure 1. Rail-to-Rail Input/Output Voltage Range

Low IBIAS, +1.4V/800nA, Rail-to-Rail Op Amps with +1.2V Buffered Reference

Applications Information

Power-Supply Considerations

The MAX4036-MAX4039 operate from a single 1.4V (MAX4036/MAX4038) or 1.8V (MAX4037/MAX4039) to 3.6V supply. A high amplifier power-supply rejection ratio of 82dB and the excellent reference line regulation allow the devices to be powered directly from a decaying battery voltage, simplifying design and extending battery life. The MAX4036-MAX4039 are ideally suited for low-voltage battery-powered systems. The *Typical Operating Characteristics* show the changes in supply current and reference output as a function of supply voltage.

Power-Up Settling Time

The MAX4036-MAX4039 typically require 0.25ms to power-up. During this startup time, the output is indeterminate. The application circuit should allow for this initial delay. See the *Typical Operating Characteristics* for amplifier and reference settling time curves.

Driving Capacitive Loads: Op Amps

The MAX4036-MAX4039 amplifier(s) require no output capacitor for stability, and are unity-gain stable for loads up to 5000pF. Applications that require greater capacitive-drive capability should use an isolation resistor between the output and the capacitive load (Figure 2). Note that this solution reduces the gain and output voltage swing because R_{ISO} forms a voltage-divider with the load resistor.

Crossover Distortion

The MAX4036-MAX4039 output stages are capable of sourcing and sinking currents with orders of magnitude greater than the stages' quiescent current, which is less than 1 μ A. This ability to drive heavy loads with such a small quiescent current introduces crossover

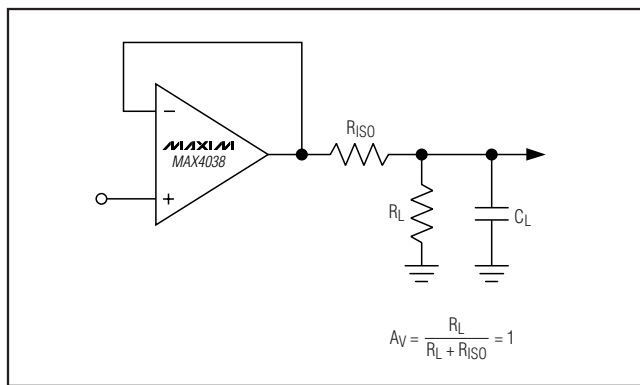

Figure 2. Using a Resistor to Isolate a Capacitive Load from the Op Amp

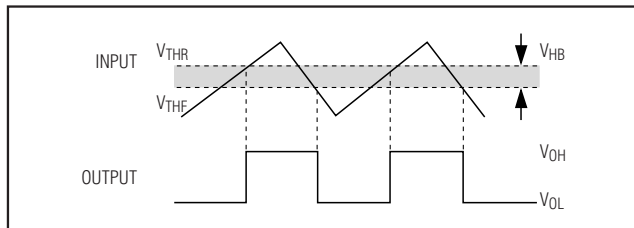

Figure 3. Hysteresis

distortion as the output stage passes between sinking and sourcing. In the crossover regions, the output impedance of the MAX4036-MAX4039 increases substantially, thereby changing the load-driving characteristics. The distortion can be greatly reduced by increasing the load resistance. For applications where low load resistance is required, bias the load such that the output current is always in one direction, to avoid crossover distortion.

Reference Bypassing

The MAX4037/MAX4039 reference requires no external capacitors.

Using the MAX4036-MAX4039 as a Comparator

Although optimized for use as an operational amplifier, the MAX4036-MAX4039 can be used as a rail-to-rail I/O comparator (Figures 3, 4). External hysteresis can be used to minimize the risk of output oscillation. The positive feedback circuit, shown in Figure 4, causes the input threshold to change when the output voltage changes state.

Battery Monitoring Using the MAX4037/MAX4039 and Hysteresis

The internal reference and low operating voltage of the MAX4037/MAX4039 make the devices ideal for battery-monitoring applications. Hysteresis can be set using resistors as shown in Figure 4, and the following design procedure:

- 1) Choose R_3 . The input bias current of IN_{+} is under 100pA over temperature, so a current through R_3 around 100nA maintains accuracy. The current through R_3 at the trip point is V_{REF} / R_3 , or 100nA for $R_3 = 12M\Omega$. $10M\Omega$ is a good practical value.
- 2) Choose the hysteresis voltage (V_{HB}), the voltage between the upper and lower thresholds. In this example, choose $V_{HB} = 50mV$ (see Figure 3).

Low IBIAS, +1.4V/800nA, Rail-to-Rail Op Amps with +1.2V Buffered Reference

3) Calculate R1:

$$\begin{aligned} R1 &= R3 \times \frac{V_{HB}}{V_{DD}} \\ &= 10M\Omega \times \frac{0.5V}{2.4V} \\ &= 210k\Omega \end{aligned}$$

4) Choose the threshold voltage for V_{IN} rising (V_{THR}). In this example, choose $V_{THR} = 2.0V$.

5) Calculate R2:

$$\begin{aligned} R2 &= \frac{1}{\left[\left(\frac{V_{THR}}{V_{REF} \times R1} \right) - \frac{1}{R1} - \frac{1}{R3} \right]} \\ &= \frac{1}{\left[\left(\frac{2.0V}{1.2V \times 210k\Omega} \right) - \frac{1}{210k\Omega} - \frac{1}{10M\Omega} \right]} \\ &= 325k\Omega \end{aligned}$$

6) Verify the threshold voltages with these formulas:
 V_{IN} rising:

$$V_{THR} = V_{REF} \times R1 \times \left(\frac{1}{R1} + \frac{1}{R2} + \frac{1}{R3} \right)$$

V_{IN} falling:

$$V_{THF} = V_{THR} - \left(\frac{R1 \times V_{DD}}{R3} \right)$$

In this application, the MAX4036-MAX4039 supply current will vary, depending on the output state of the comparator.

Power Supplies and Layout

The MAX4036-MAX4039 operate from a single 1.4V (MAX4036/MAX4038) or 1.8V (MAX4037/MAX4039) to 3.6V power supply. Bypass V_{DD} with a 0.1 μ F capacitor to ground to minimize noise.

Good layout techniques optimize performance by decreasing the amount of stray capacitance to the op amp's inputs and outputs. To decrease stray capacitance, minimize trace lengths by placing external components close to the device.

The exposed paddle (EP) on the TDFN packages of the MAX4038 and MAX4039 is internally connected to the device substrate, V_{SS} . Connect the exposed paddle to V_{SS} or leave EP unconnected. Running traces below the exposed paddle is not recommended.

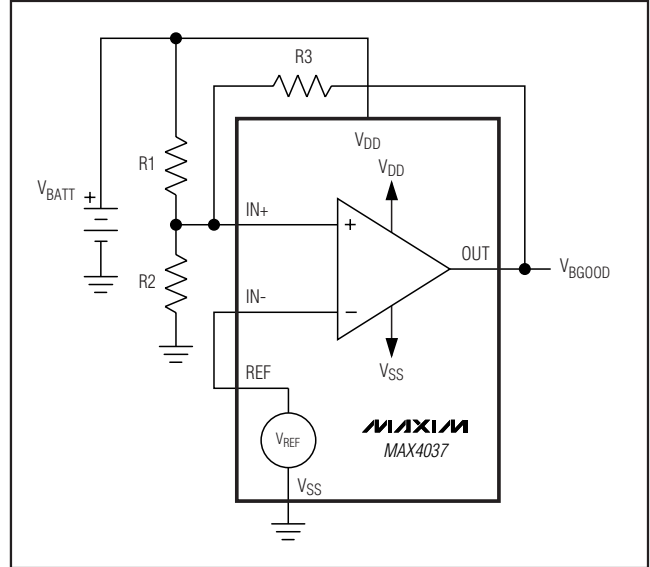

Figure 4. Battery Monitoring

Selector Guide

| PART | NO. OF AMPLIFIERS | REFERENCE |
|---------|-------------------|-----------|
| MAX4036 | 1 | — |
| MAX4037 | 1 | ✓ |
| MAX4038 | 2 | — |
| MAX4039 | 2 | ✓ |

Ordering Information (continued)

| PART | TEMP RANGE | PIN-PACKAGE | TOP MARK |
|--------------|----------------|--------------|----------|
| MAX4039EBL-T | -40°C to +85°C | 9 UCSP | AEH |
| MAX4039ETB-T | -40°C to +85°C | 10 TDFN-EP* | AAN |
| MAX4039EUB | -40°C to +85°C | 10 μ MAX | — |

-Denotes a package containing lead.

*EP = Exposed pad.

Chip Information

MAX4036 TRANSISTOR COUNT: 49
 MAX4037 TRANSISTOR COUNT: 119
 MAX4038 TRANSISTOR COUNT: 146
 MAX4039 TRANSISTOR COUNT: 146
 PROCESS: BiCMOS

Low IBIAS, +1.4V/800nA, Rail-to-Rail Op Amps with +1.2V Buffered Reference

Pin Configurations

MAX4036-MAX4039

TOP VIEW

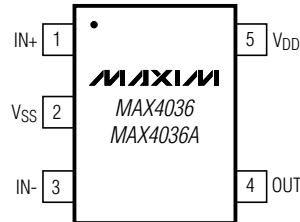

SC70

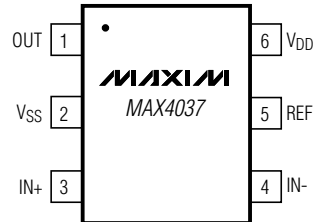

SOT23

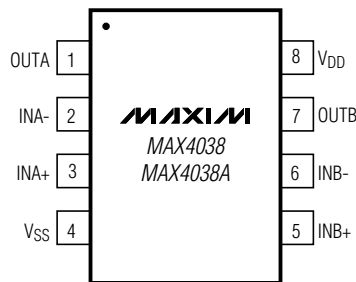

μMAX

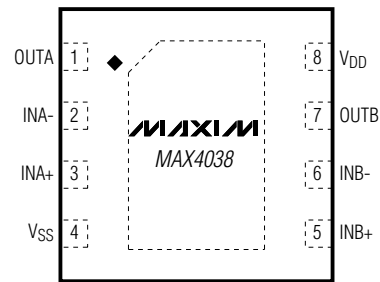

3mm x 3mm x 0.8mm TDFN
TDFN EXPOSED PAD CONNECTED TO V_{SS}.

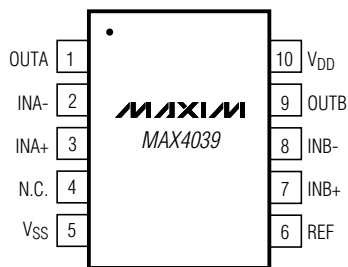

μMAX

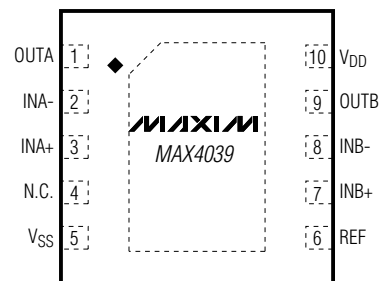

3mm x 3mm x 0.8mm TDFN
TDFN EXPOSED PAD CONNECTED TO V_{SS}.

MAXIM
MAX4038

(BUMP SIDE DOWN)

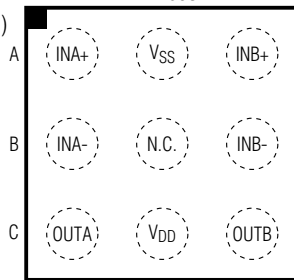

UCSP

MAXIM
MAX4039

(BUMP SIDE DOWN)

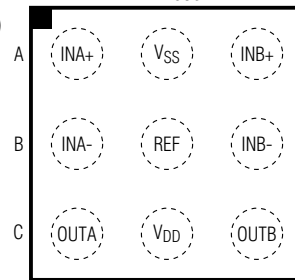

UCSP

Low IBIAS, +1.4V/800nA, Rail-to-Rail Op Amps with +1.2V Buffered Reference

Package Information

For the latest package outline information and land patterns, go to www.maxim-ic.com/packages. Note that a "+", "#", or "-" in the package code indicates RoHS status only. Package drawings may show a different suffix character, but the drawing pertains to the package regardless of RoHS status.

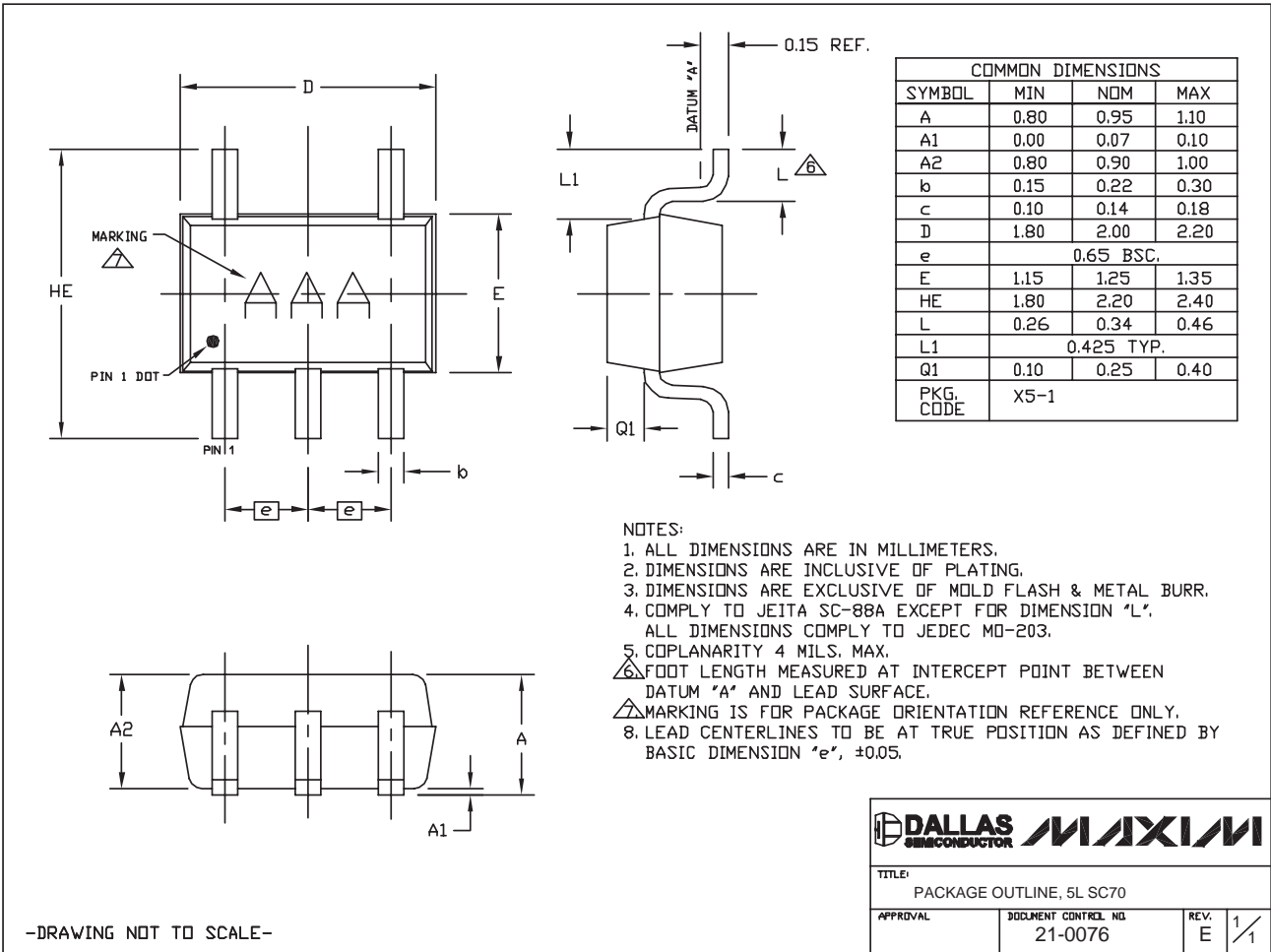

SC70, 5LEPS

DALLAS SEMICONDUCTOR **MAXIM**

TITLE: PACKAGE OUTLINE, 5L SC70

| | | | |
|----------|---------------------------------|-----------|-----|
| APPROVAL | DOCUMENT CONTROL NO. 21-0076 | REV. E | 1/1 |
|----------|---------------------------------|-----------|-----|

Low IBIAS, +1.4V/800nA, Rail-to-Rail Op Amps with +1.2V Buffered Reference

Package Information (continued)

For the latest package outline information and land patterns, go to www.maxim-ic.com/packages. Note that a "+", "#", or "-" in the package code indicates RoHS status only. Package drawings may show a different suffix character, but the drawing pertains to the package regardless of RoHS status.

MAX4036-MAX4039

6LSOT.EPS

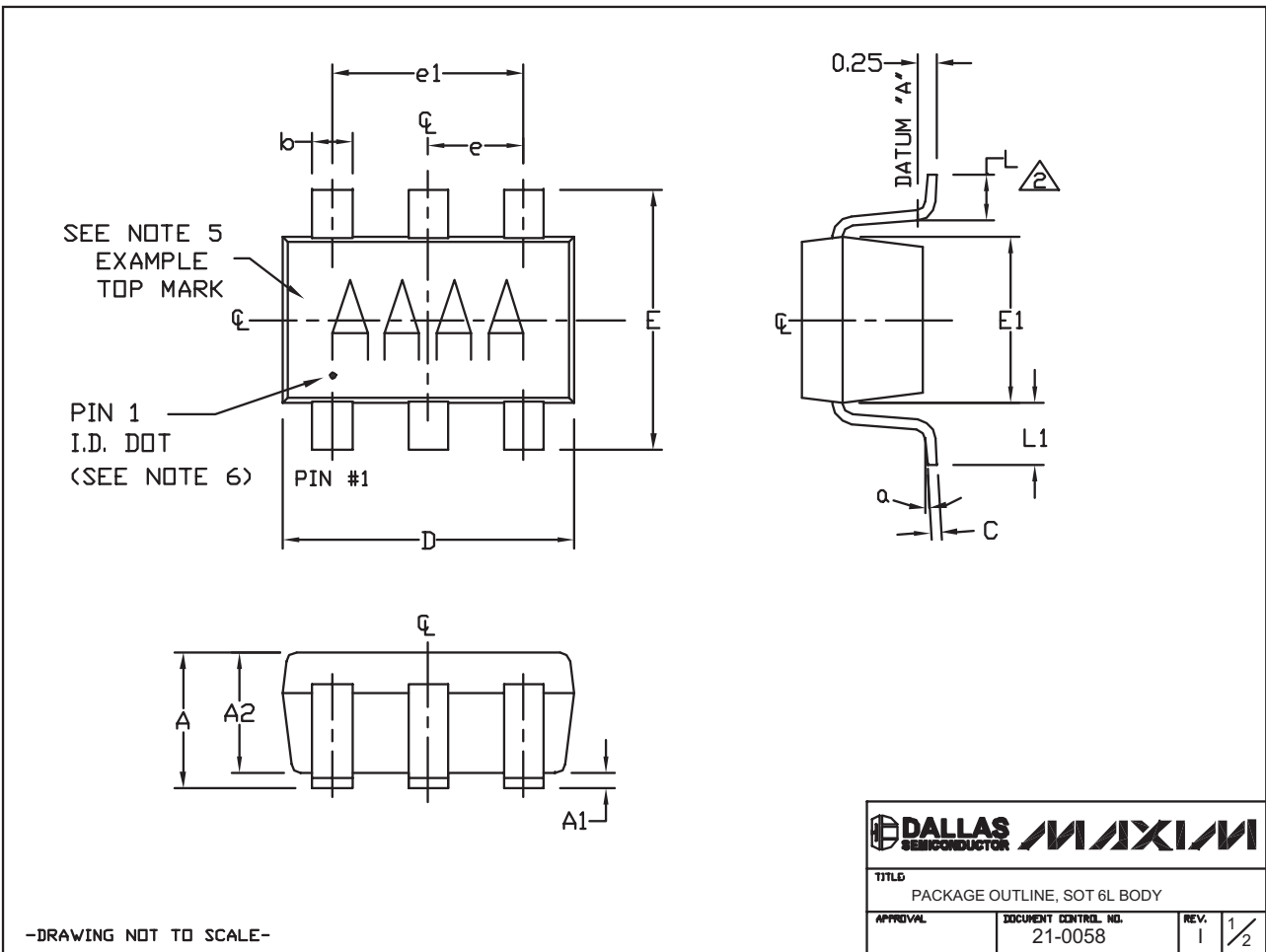

Low IBIAS, +1.4V/800nA, Rail-to-Rail Op Amps with +1.2V Buffered Reference

Package Information (continued)

For the latest package outline information and land patterns, go to www.maxim-ic.com/packages. Note that a "+", "#", or "-" in the package code indicates RoHS status only. Package drawings may show a different suffix character, but the drawing pertains to the package regardless of RoHS status.

NOTES:

1. ALL DIMENSIONS ARE IN MILLIMETERS.
2. FOOT LENGTH MEASURED AT INTERCEPT POINT BETWEEN DATUM A & LEAD SURFACE.
3. PACKAGE OUTLINE EXCLUSIVE OF MOLD FLASH & METAL BURR. MOLD FLASH, PROTRUSION OR METAL BURR SHOULD NOT EXCEED 0.25mm.
4. PACKAGE OUTLINE INCLUSIVE OF SOLDER PLATING.
5. PIN 1 IS LOWER LEFT PIN WHEN READING TOP MARK FROM LEFT TO RIGHT. (SEE EXAMPLE TOP MARK)
6. PIN 1 I.D. DOT IS 0.3mm ϕ MIN. LOCATED ABOVE PIN 1.
7. MEETS JEDEC MO17B, VARIATION AB.
8. SOLDER THICKNESS MEASURED AT FLAT SECTION OF LEAD BETWEEN 0.08mm AND 0.15mm FROM LEAD TIP.
9. LEAD TO BE COPLANAR WITHIN 0.1mm.
10. NUMBER OF LEADS SHOWN ARE FOR REFERENCE ONLY.
11. MARKING IS FOR PACKAGE ORIENTATION REFERENCE ONLY.

| SYMBOL | MIN | NOMINAL | MAX |
|--------|-----------|---------|------|
| A | 0.90 | 1.25 | 1.45 |
| A1 | 0.00 | 0.05 | 0.15 |
| A2 | 0.90 | 1.10 | 1.30 |
| b | 0.35 | 0.40 | 0.50 |
| C | 0.08 | 0.15 | 0.20 |
| D | 2.80 | 2.90 | 3.00 |
| E | 2.60 | 2.80 | 3.00 |
| E1 | 1.50 | 1.625 | 1.75 |
| L | 0.35 | 0.45 | 0.60 |
| L1 | 0.60 REF. | | |
| e1 | 1.90 BSC. | | |
| e | 0.95 BSC. | | |
| a | 0* | 2.5* | 10* |

PKG CODES:
 U6-1, U6-2, U6-4, U6C-8,
 U6SN-1, U6CN-2, U6S-3, U6F-5,
 U6F-6, U6FH-5, U6FH-6

-DRAWING NOT TO SCALE-

| | | | |
|------------------------------|----------------------|------|-----|
| | | | |
| TITLE | | | |
| PACKAGE OUTLINE, SOT 6L BODY | | | |
| APPROVAL | DOCUMENT CONTROL NO. | REV. | |
| | 21-0058 | 1 | 2/2 |

Low IBIAS, +1.4V/800nA, Rail-to-Rail Op Amps with +1.2V Buffered Reference

Package Information (continued)

For the latest package outline information and land patterns, go to www.maxim-ic.com/packages. Note that a "+", "#", or "-" in the package code indicates RoHS status only. Package drawings may show a different suffix character, but the drawing pertains to the package regardless of RoHS status.

MAX4036-MAX4039

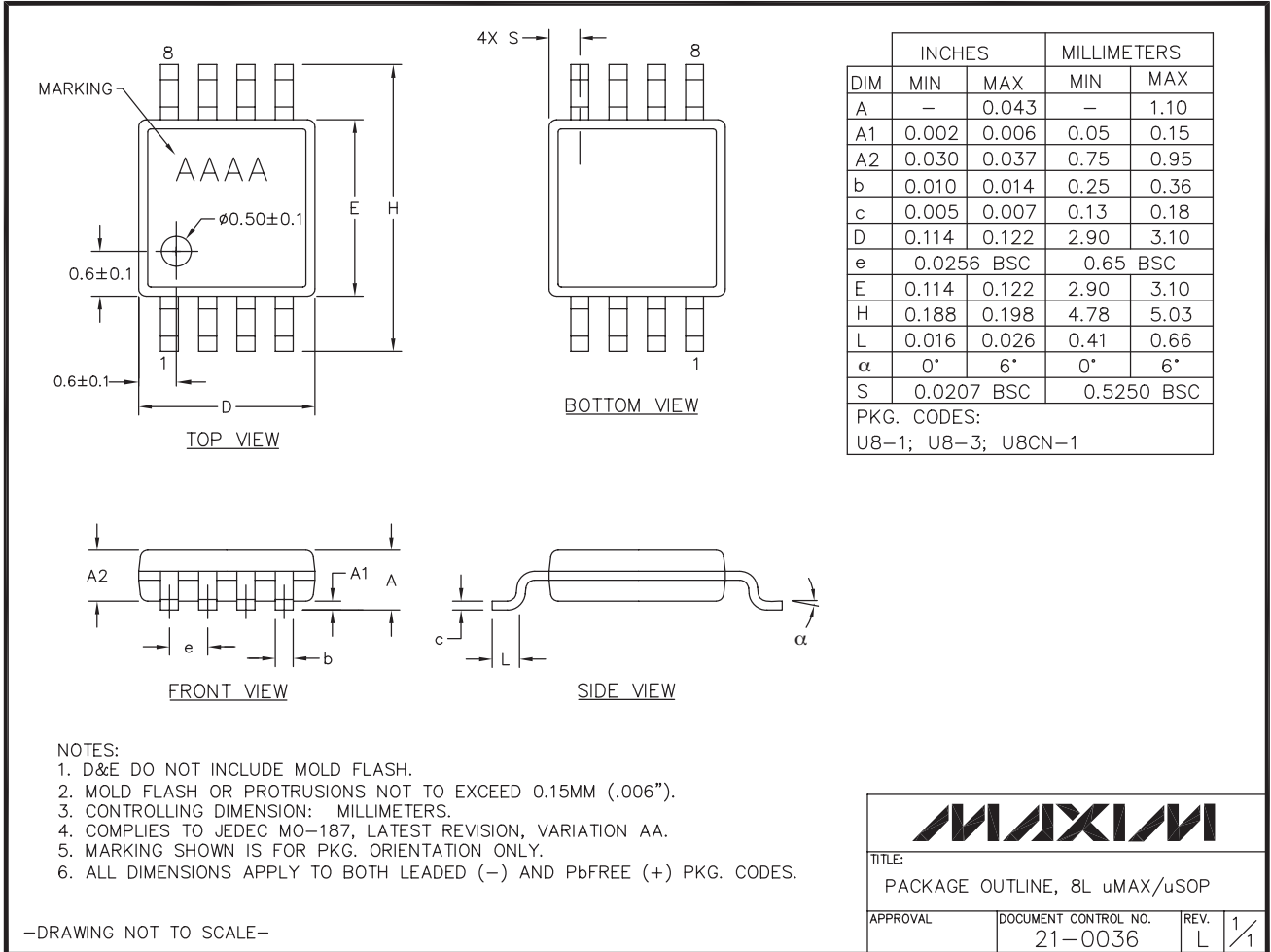

Low IBIAS, +1.4V/800nA, Rail-to-Rail Op Amps with +1.2V Buffered Reference

Package Information (continued)

For the latest package outline information and land patterns, go to www.maxim-ic.com/packages. Note that a "+", "#", or "-" in the package code indicates RoHS status only. Package drawings may show a different suffix character, but the drawing pertains to the package regardless of RoHS status.

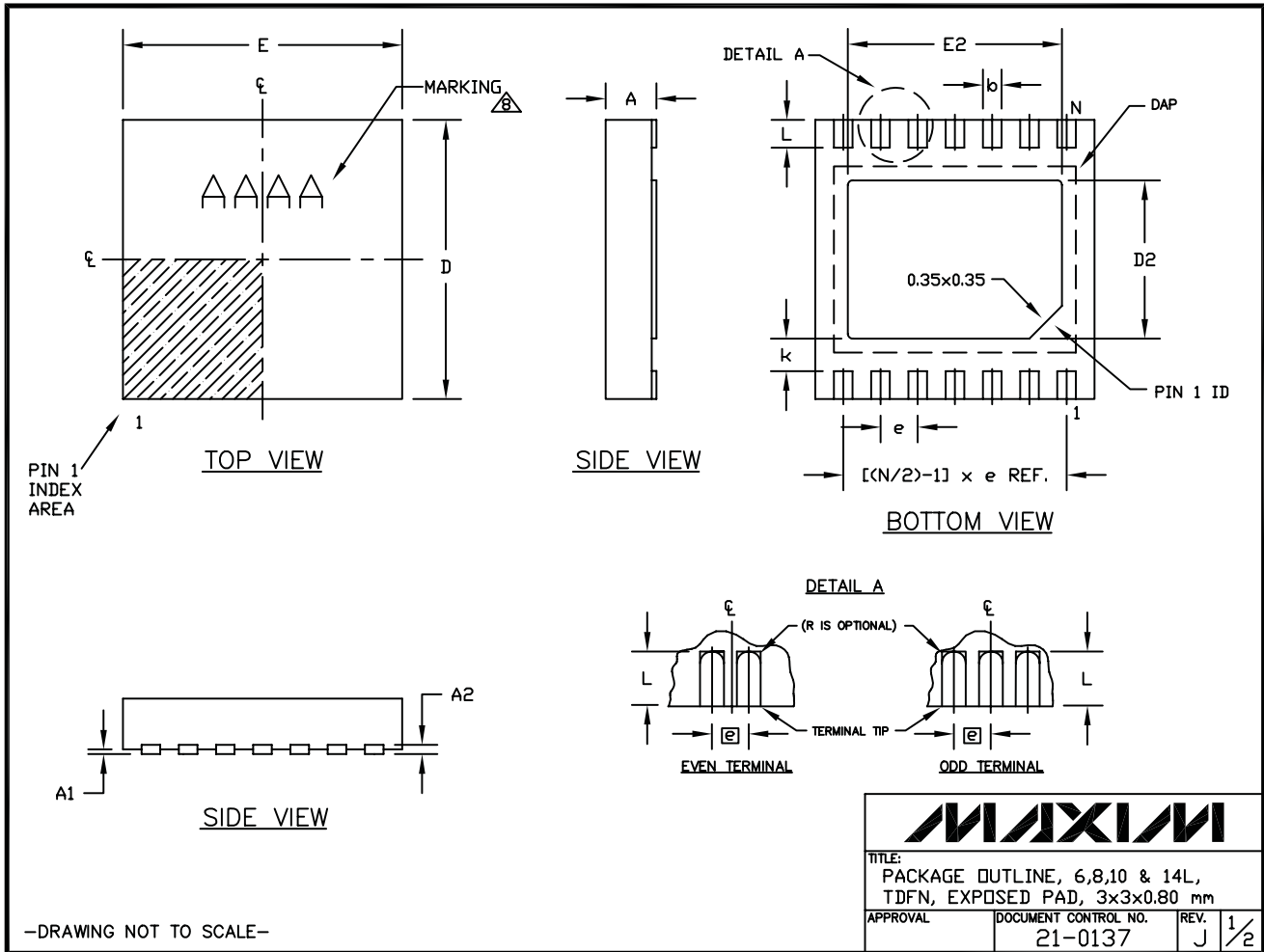

Low IBIAS, +1.4V/800nA, Rail-to-Rail Op Amps with +1.2V Buffered Reference

Package Information (continued)

For the latest package outline information and land patterns, go to www.maxim-ic.com/packages. Note that a "+", "#", or "-" in the package code indicates RoHS status only. Package drawings may show a different suffix character, but the drawing pertains to the package regardless of RoHS status.

MAX4036-MAX4039

| COMMON DIMENSIONS | | |
|-------------------|-----------|------|
| SYMBOL | MIN. | MAX. |
| A | 0.70 | 0.80 |
| D | 2.90 | 3.10 |
| E | 2.90 | 3.10 |
| A1 | 0.00 | 0.05 |
| L | 0.20 | 0.40 |
| k | 0.25 MIN. | |
| A2 | 0.20 REF. | |

| PACKAGE VARIATIONS | | | | | | | |
|--------------------|----|-----------|-----------|----------|----------------|-----------|---------------|
| PKG. CODE | N | D2 | E2 | e | JEDEC SPEC | b | [(N/2)-1] x e |
| T633-2 | 6 | 1.50±0.10 | 2.30±0.10 | 0.95 BSC | MO229 / WEEA | 0.40±0.05 | 1.90 REF |
| T833-2 | 8 | 1.50±0.10 | 2.30±0.10 | 0.65 BSC | MO229 / WEEC | 0.30±0.05 | 1.95 REF |
| T833-3 | 8 | 1.50±0.10 | 2.30±0.10 | 0.65 BSC | MO229 / WEEC | 0.30±0.05 | 1.95 REF |
| T1033-1 | 10 | 1.50±0.10 | 2.30±0.10 | 0.50 BSC | MO229 / WEED-3 | 0.25±0.05 | 2.00 REF |
| T1033MK-1 | 10 | 1.50±0.10 | 2.30±0.10 | 0.50 BSC | MO229 / WEED-3 | 0.25±0.05 | 2.00 REF |
| T1033-2 | 10 | 1.50±0.10 | 2.30±0.10 | 0.50 BSC | MO229 / WEED-3 | 0.25±0.05 | 2.00 REF |
| T1433-1 | 14 | 1.70±0.10 | 2.30±0.10 | 0.40 BSC | ---- | 0.20±0.05 | 2.40 REF |
| T1433-2 | 14 | 1.70±0.10 | 2.30±0.10 | 0.40 BSC | ---- | 0.20±0.05 | 2.40 REF |
| T1433-3F | 14 | 1.70±0.10 | 2.30±0.10 | 0.40 BSC | ---- | 0.20±0.05 | 2.40 REF |

NOTES:

1. ALL DIMENSIONS ARE IN mm. ANGLES IN DEGREES.
2. COPLANARITY SHALL NOT EXCEED 0.08 mm.
3. WARPAGE SHALL NOT EXCEED 0.10 mm.
4. PACKAGE LENGTH/PACKAGE WIDTH ARE CONSIDERED AS SPECIAL CHARACTERISTIC(S).
5. DRAWING CONFORMS TO JEDEC MO229, EXCEPT DIMENSIONS "D2" AND "E2", AND T1433-1 & T1433-2.
6. "N" IS THE TOTAL NUMBER OF LEADS.
7. NUMBER OF LEADS SHOWN ARE FOR REFERENCE ONLY.
8. MARKING IS FOR PACKAGE ORIENTATION REFERENCE ONLY.
9. ALL DIMENSIONS APPLY TO BOTH LEADED (-) AND PbFREE (+) PKG. CODES.

-DRAWING NOT TO SCALE-

| | | |
|---|---------------------------------|------------|
|  | | |
| TITLE: PACKAGE OUTLINE, 6,8,10 & 14L, TDFN, EXPOSED PAD, 3x3x0.80 mm | | |
| APPROVAL | DOCUMENT CONTROL NO. 21-0137 | REV. J 2/2 |

Low IBIAS, +1.4V/800nA, Rail-to-Rail Op Amps with +1.2V Buffered Reference

Package Information (continued)

For the latest package outline information and land patterns, go to www.maxim-ic.com/packages. Note that a "+", "#", or "-" in the package code indicates RoHS status only. Package drawings may show a different suffix character, but the drawing pertains to the package regardless of RoHS status.

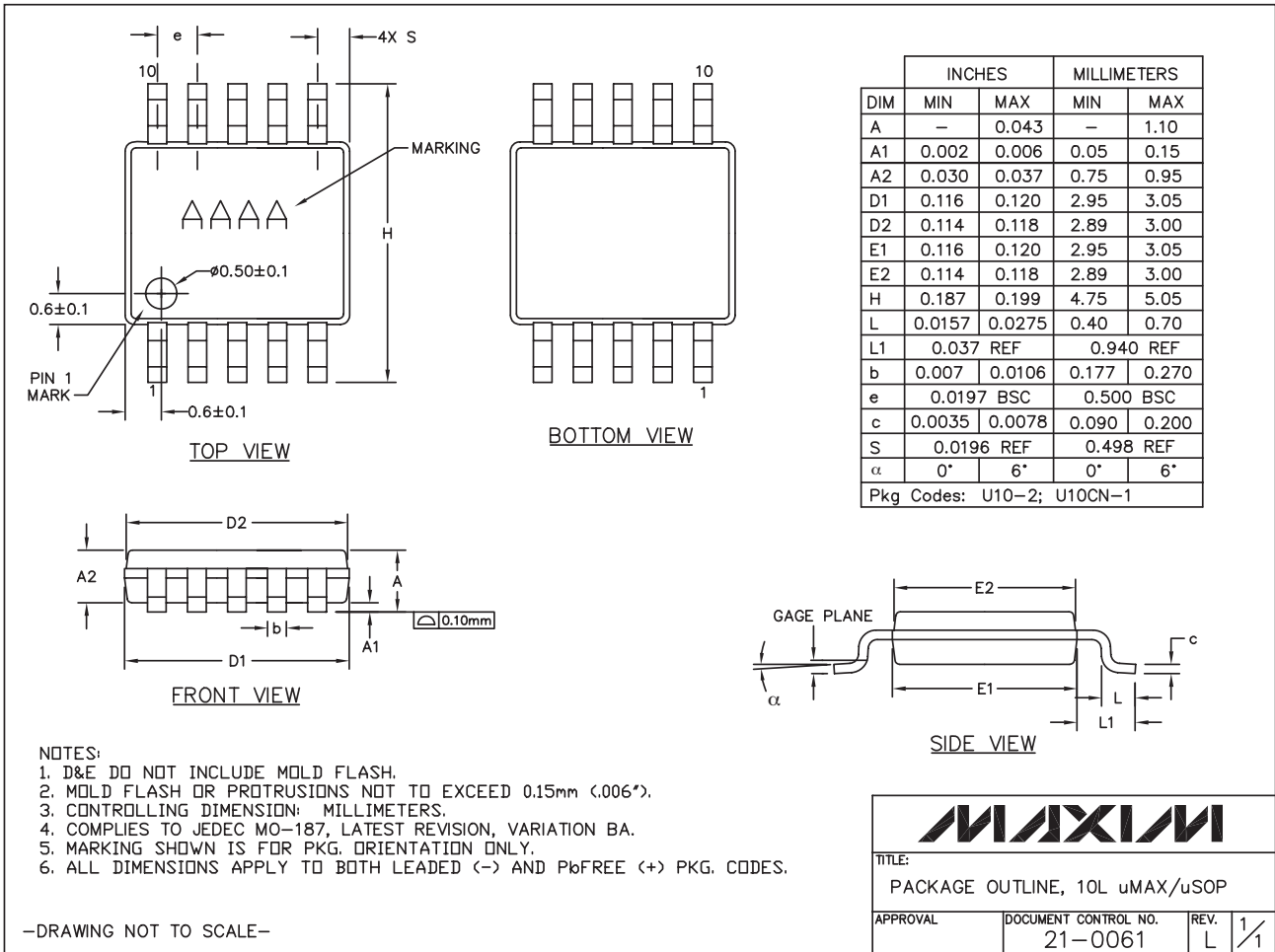

10LUMAX.EPS



| | | |
|--------------------------------|----------------------|-------|
| TITLE: | | |
| PACKAGE OUTLINE, 10L uMAX/uSOP | | |
| APPROVAL | DOCUMENT CONTROL NO. | REV. |
| | 21-0061 | L 1/1 |

Low IBIAS, +1.4V/800nA, Rail-to-Rail Op Amps with +1.2V Buffered Reference

Package Information (continued)

For the latest package outline information and land patterns, go to www.maxim-ic.com/packages. Note that a "+", "#", or "-" in the package code indicates RoHS status only. Package drawings may show a different suffix character, but the drawing pertains to the package regardless of RoHS status.

MAX4036-MAX4039

91LUCSP, 3x3.EPS

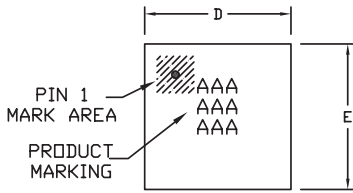

TOP VIEW

| COMMON DIMENSIONS | |
|-------------------|----------------|
| A | 0.62±0.05-0.08 |
| A1 | 0.29±0.02 |
| A2 | 0.33 REF. |
| b | ∅0.35±0.03 |
| D1 | 1.00 BASIC |
| E1 | 1.00 BASIC |
| e | 0.50 BASIC |
| SD | 0.00 BASIC |
| SE | 0.00 BASIC |

| PKG. CODE | VARIABLE DIMENSIONS | | DEPOPULATED SOLDER BALLS |
|-----------|---------------------|-----------|--------------------------|
| | D | E | |
| B9-1 | 1.52±0.05 | 1.52±0.05 | NONE |
| B9-2 | 1.52±0.05 | 1.52±0.05 | B2 |
| B9-3 | 1.52±0.05 | 1.52±0.05 | B1, B2, B3 |
| B9-4 | 1.60±0.05 | 1.60±0.05 | NONE |
| B9-5 | 1.60±0.05 | 1.60±0.05 | B2 |
| B9-6 | 1.60±0.05 | 1.60±0.05 | B1, B2, B3 |
| B9-7 | 1.52±0.05 | 1.52±0.05 | A2, B1, B2, B3, C2 |
| B9-8 | 1.98±0.05 | 1.75±0.05 | B1, B2, B3 |

NOTES:

1. ALL DIMENSIONS ARE IN MILLIMETERS.
2. PRODUCT MARKING: NUMBER OF CHARACTERS AND LINES VARY PER PRODUCT.

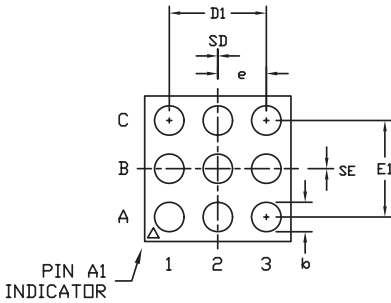

BOTTOM VIEW

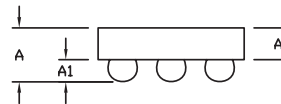

SIDE VIEW

-DRAWING NOT TO SCALE-

| | | |
|----------------------------------|------------------------------|------------|
| | | |
| TITLE: PACKAGE OUTLINE, 3x3 UCSP | | |
| APPROVAL | DOCUMENT CONTROL NO. 21-0093 | REV. L 1/1 |

Low IBIAS, +1.4V/800nA, Rail-to-Rail Op Amps with +1.2V Buffered Reference

Revision History

| REVISION NUMBER | REVISION DATE | DESCRIPTION | PAGES CHANGED |
|------------------------|----------------------|--------------------|----------------------|
| 5 | 11/09 | Updated TOC 20 | 7 |

Maxim cannot assume responsibility for use of any circuitry other than circuitry entirely embodied in a Maxim product. No circuit patent licenses are implied. Maxim reserves the right to change the circuitry and specifications without notice at any time.

22 _____ **Maxim Integrated Products, 120 San Gabriel Drive, Sunnyvale, CA 94086 408-737-7600**

Looking for pricing, stock, or lifecycle information?

Click below to explore more details on WIN SOURCE:

 [View MAX4039EUB+T on WIN SOURCE](#)

 [Maxim Integrated Information](#)

Optimize Your Supply Chain with WIN SOURCE Solutions

-  Global Sourcing Solution
-  Obsolete Management
-  Cost Control Management
-  Shortage Management
-  Alternative Solution
-  Excess Inventory Management