



**THE DATASHEET OF
MAX2640EUT+**



MAX2640/MAX2641

300MHz to 2500MHz SiGe Ultra-Low-Noise Amplifiers

General Description

The MAX2640/MAX2641 are low-cost, ultra-low-noise amplifiers designed for applications in the cellular, PCS, GPS, and 2.4GHz ISM frequency bands. Operating from a single +2.7V to +5.5V supply, these devices consume only 3.5mA of current while providing a low noise figure, high gain, high input IP3, and an operating frequency range that extends from 300MHz to 2500MHz.

The MAX2640 is optimized for 300MHz to 1500MHz applications, with a typical performance of 15.1dB gain, input IP3 of -10dBm, and a noise figure of 0.9dB at 900MHz. The MAX2641 is optimized for 1400MHz to 2500MHz applications, with a typical performance of 14.4dB gain, an input IP3 of -4dBm, and a noise figure of 1.3dB at 1900MHz.

These devices are internally biased, eliminating the need for external bias resistors and chokes. In a typical application, the only external components needed are a two-element input match, input and output blocking capacitors, and a V_{CC} bypass capacitor.

The MAX2640/MAX2641 are designed on a high-frequency, low-noise, advanced silicon-germanium process and are offered in the space-saving, 6-pin SOT23 package.

Applications

- 315MHz/400MHz/900MHz/2.4GHz ISM Radios
- Cellular/PCS Handsets
- GPS Receivers
- Cordless Phones
- Wireless LANs
- Wireless Data

Typical Operating Circuit

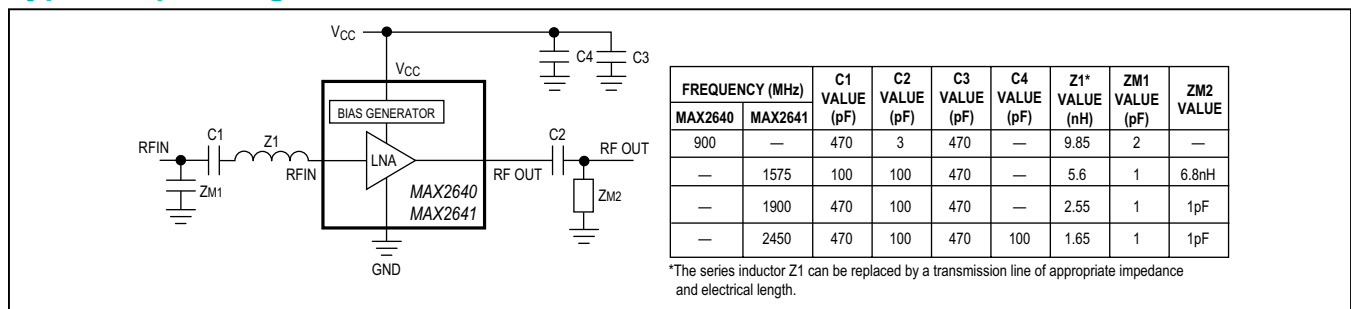

Features

- Wide Operating Frequency Range
MAX2640: 300MHz to 1500MHz
MAX2641: 1400MHz to 2500MHz
- Low Noise Figure
MAX2640: 0.9dB at 900MHz
MAX2641: 1.2dB at 1575MHz
1.3dB at 1900MHz
1.5dB at 2450MHz
- High Gain
MAX2640: 15.1dB at 900MHz
MAX2641: 15.7dB at 1575MHz
14.4dB at 1900MHz
13.5dB at 2450MHz
- High Reverse Isolation
MAX2640: 40dB at 900MHz
MAX2641: 31dB at 1575MHz
30dB at 1900MHz
24dB at 2450MHz
- +2.7V to +5.5V Single-Supply Operation
- Low 3.5mA Supply Current
- Ultra-Small SOT23-6 Package

Ordering Information

PART	TEMP RANGE	PIN-PACKAGE	SOFT TOP MARK
MAX2640EUT-T	-40°C to +85°C	6 SOT23	AAAV
MAX2640EUT+T	-40°C to +85°C	6 SOT23	AAAV
MAX2640AUT+T	-40°C to +125°C	6 SOT23	AAAV
MAX2641EUT-T	-40°C to +85°C	6 SOT23	AAAW
MAX2641EUT+T	-40°C to +125°C	6 SOT23	AAAW

+Denotes a lead(Pb)-free/RoHS-compliant package.
T = Tape and reel.

Pin Configuration appears at end of data sheet.

Absolute Maximum Ratings

V _{CC} to GND	-0.3V to +6V	Operating Temperature Range	
RFIN Power (50Ω source) (Note 1)	+5dBm	MAX2640EUT/MAX2641EUT.....	-40°C to +85°C
Continuous Power Dissipation (T _A = +70°C)		MAX2640AUT.....	-40°C to +125°C
SOT23-6 (derate 8.7mW/°C above +70°C)	696mW	Storage Temperature Range	-65°C to +160°C
		Lead Temperature (soldering, 10s)	+300°C

Stresses beyond those listed under "Absolute Maximum Ratings" may cause permanent damage to the device. These are stress ratings only, and functional operation of the device at these or any other conditions beyond those indicated in the operational sections of the specifications is not implied. Exposure to absolute maximum rating conditions for extended periods may affect device reliability.

Note 1: Pin must be AC-coupled with a DC blocking capacitor.

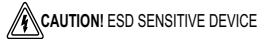

DC Electrical Characteristics

(V_{CC} = +2.7V to +5.5V, T_A = -40°C to +85°C (MAX2640EUT/MAX2641EUT), T_A = -40°C to +125°C (MAX2640AUT), unless otherwise noted. Typical values are at V_{CC} = +3.0V, T_A = +25°C.) Limits at T_A = +25°C are guaranteed by production test. Limits over temperature are guaranteed by design and characterization.

PARAMETER	CONDITIONS	MIN	TYP	MAX	UNITS
Operating Supply Voltage		2.7		5.5	V
Operating Supply Current	T _A = +25°C		3.5	4.7	mA
	T _A = -40°C to +85°C (MAX2640EUT/MAX2641EUT)			6.4	
	T _A = -40°C to +125°C (MAX2640AUT)			7.8	

RF Electrical Characteristics

(V_{CC} = +3.0V, P_{RFIN} = -34dBm, Z_O = 50Ω, T_A = +25°C, unless otherwise noted.) (Notes 2 and 3)

PARAMETER	CONDITIONS	MIN	TYP	MAX	UNITS
MAX2640 (f_{RFIN} = 900MHz)					
RFIN Frequency Range		300		1500	MHz
Gain		12.8	15.1		dB
Gain Variation Over Temperature	T _A = -40°C to +85°C (MAX2640EUT)		0.6	1.7	dB
	T _A = -40°C to +125°C (MAX2640AUT)		0.9	2.5	
Noise Figure	(Note 4)		0.9	1.1	dB
Input Return Loss			-11		dB
Output Return Loss			-14		dB
Reverse Isolation			40		dB
Input 1dB Gain Compression Point			-22		dBm
Input Third-Order Intercept Point	(Note 5)		-10		dBm
MAX2641 (f_{RFIN} = 1900MHz)					
RFIN Frequency Range		1400		2500	MHz
Gain		12.4	14.4		dB
Gain Variation Over Temperature	T _A = T _{MIN} to T _{MAX}		0.9	2.4	dB
Noise Figure	(Note 4)		1.3	1.5	dB
Input Return Loss			-12		dB
Output Return Loss			-12		dB
Reverse Isolation			30		dB
Input 1dB Gain Compression Point			-21		dBm
Input Third-Order Intercept Point	(Note 6)		-4		dBm

RF Electrical Characteristics (continued)

($V_{CC} = +3.0V$, $P_{RFIN} = -34dBm$, $Z_O = 50\Omega$, $T_A = +25^\circ C$, unless otherwise noted.) (Notes 2 and 3)

PARAMETER	CONDITIONS	MIN	TYP	MAX	UNITS
MAX2641 ($f_{RFIN} = 1575MHz$)					
Gain			15.7		dB
Noise Figure	(Note 4)		1.2		dB
Input Return Loss			-8		dB
Output Return Loss			-15		dB
Reverse Isolation			-31		dB
Input 1dB Gain Compression Point			-21		dBm
Input Third-Order Intercept Point	(Note 7)		+1.4		dBm
MAX2641 ($f_{RFIN} = 2450MHz$)					
Gain			13.5		dB
Noise Figure	(Note 4)		1.5		dB
Input Return Loss			-10		dB
Output Return Loss			-11		dB
Reverse Isolation			-24		dB
Input 1dB Gain Compression Point			-19		dBm
Input Third-Order Intercept Point	(Note 8)		-2.5		dBm

Note 2: Guaranteed by design and characterization.

Note 3: Measured using typical operating circuit. Input and output impedance matching networks were optimized for best simultaneous gain and noise-figure performance.

Note 4: External component and circuit losses degrade noise-figure performance. Specification excludes external component and circuit board losses.

Note 5: Measured with two input tones, $f_1 = 899MHz$, $f_2 = 901MHz$, both at -34dBm per tone.

Note 6: Measured with two input tones, $f_1 = 1899MHz$, $f_2 = 1901MHz$, both at -34dBm per tone.

Note 7: Measured with two input tones, $f_1 = 1574MHz$, $f_2 = 1576MHz$, both at -34dBm per tone.

Note 8: Measured with two input tones, $f_1 = 2449MHz$, $f_2 = 2451MHz$, both at -34dBm per tone.

Typical Operating Characteristics

($V_{CC} = +3V$, $P_{RFIN} = -34dBm$, Typical Operating Circuit, $T_A = +25^\circ C$, unless otherwise noted.)

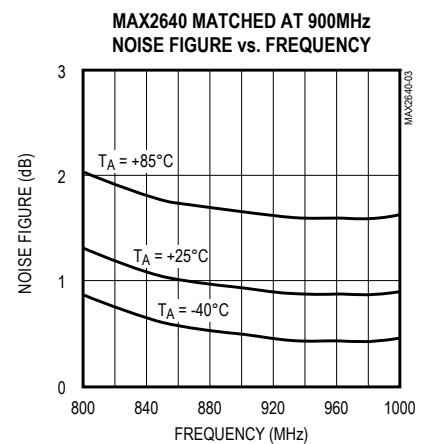
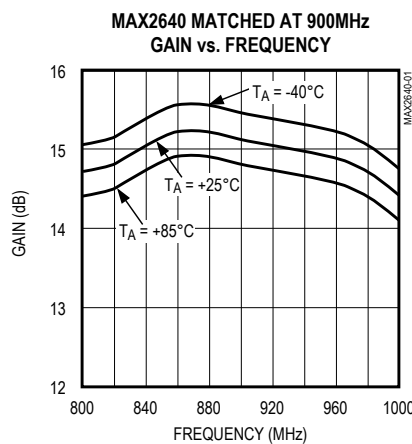
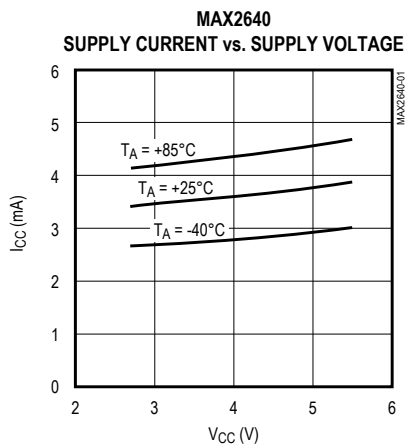

Typical Operating Characteristics (continued)

($V_{CC} = +3V$, $P_{RFIN} = -34dBm$, Typical Operating Circuit, $T_A = +25^\circ C$, unless otherwise noted.)

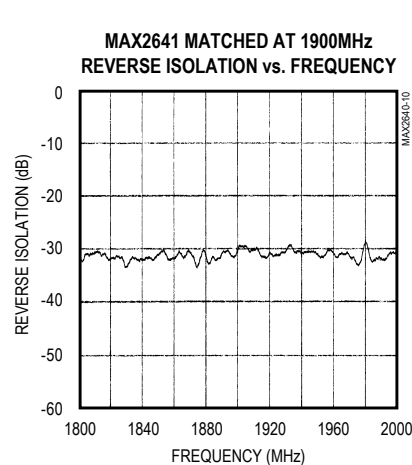
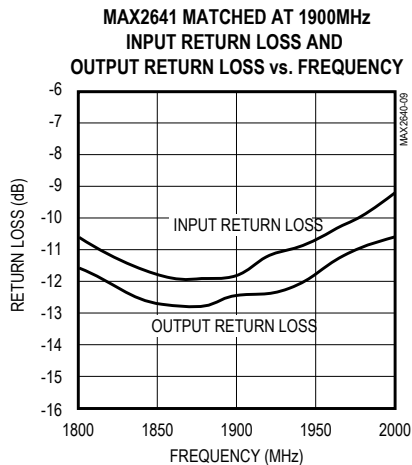
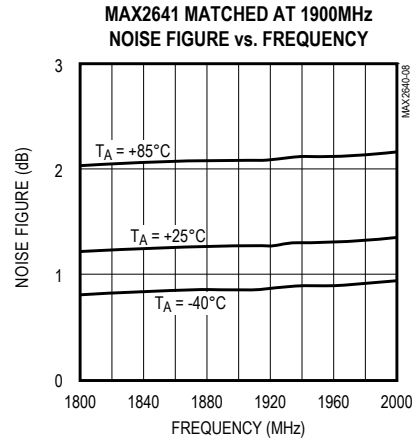
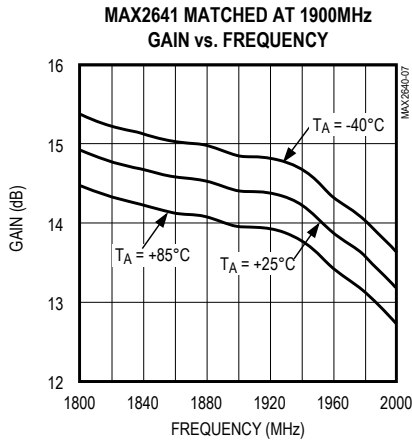
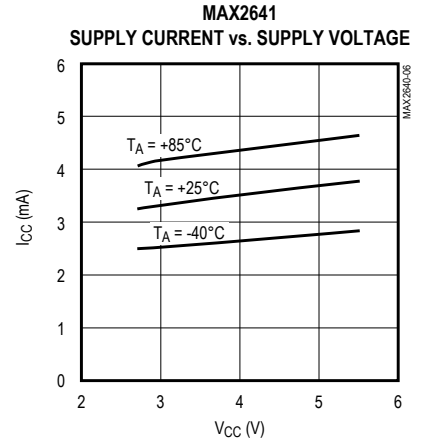
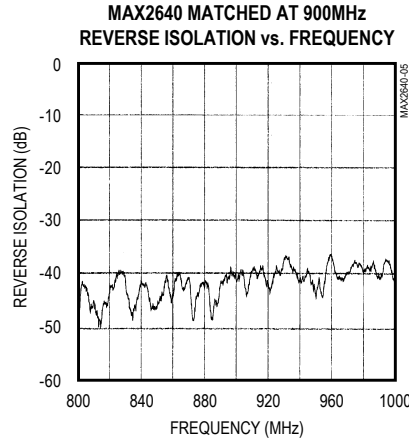
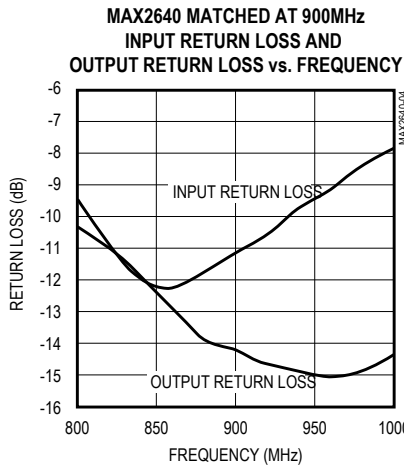

Pin Description

IN	NAME	FUNCTION
1	RFIN	Amplifier Input. AC-couple to this pin with a DC blocking capacitor. Use recommended input matching network (see Typical Operating Circuit).
2, 3, 5	GND	Ground. For optimum performance, provide a low inductance connection to the ground plane.
4	RFOUT	Amplifier Output. Use the recommended series blocking or matching capacitor (see Typical Operating Circuit).
6	V _{CC}	Supply Voltage. Bypass to ground directly at the supply pin. The value of the bypass capacitor is determined by the lowest operating frequency. Additional bypassing may be necessary for long VCC lines (see Typical Operating Circuit).

Detailed Description

The MAX2640 and MAX2641 are ultra-low-noise amplifiers that operate with RF input frequency ranges of 300MHz to 1500MHz (MAX2640) or 1400MHz to 2500MHz (MAX2641). These devices are available in SOT23-6 packages and contain internal bias circuitry to minimize the number of required external components. Their small size and low external component count make them ideal for applications where board space is limited.

Applications Information

External Matching Components

The MAX2640/MAX2641 are easy to use, generally requiring only five external components as shown in the *Typical Operating Circuit*. To reduce external component count further, replace external inductors with microstrip transmission lines. The high reverse isolation allows the tuning of the input matching network without affecting the output match, and vice versa. Select input and output matching networks to obtain the desired combination of gain, noise figure, and return loss performance. The *Typical Operating Circuit* show the recommended input and output matching networks for the MAX2640/MAX2641 at 900MHz and 1900MHz, respectively. These values are optimized for best simultaneous gain, noise figure, and return loss performance. To aid in the design of matching networks for other frequencies, Tables 1 and 2 list typical device S-parameters and Tables 3 and 4 list typical device noise parameters.

Table 1. MAX2640 Typical Scattering Parameters at $V_{CC} = +3V$, $T_A = +25^{\circ}C$

FREQUENCY (MHz)	S11 MAG	PHASE	S21 MAG	PHASE	S12 MAG	PHASE	S22 MAG	PHASE
400	0.907	-35.1	4.62	109.1	0.001	13.5	0.302	108.4
500	0.882	-43.1	4.70	90.4	0.001	64.7	0.33	93.6
600	0.858	-50.8	4.76	70.7	0.001	55.2	0.352	81.5
700	0.832	-58.1	4.80	50.6	0.002	39.4	0.365	69.4
800	0.810	-64.9	4.85	29.5	0.004	64.2	0.384	56.8
900	0.788	-71.0	4.77	9.2	0.005	36.3	0.396	44.7
1000	0.771	-76.6	4.74	-12.0	0.007	28.0	0.412	33.5
1100	0.749	-82.3	4.55	-32.4	0.010	12.3	0.436	21.9
1200	0.735	-88.0	4.48	-53.4	0.013	-10.6	0.455	10.7
1300	0.720	-93.4	4.24	-75.9	0.015	-28.2	0.469	-0.2
1400	0.702	-98.8	4.17	-94.9	0.021	-42.9	0.482	-9.9
1500	0.688	-104.9	3.81	-117.5	0.021	-59.8	0.489	-20.2

Table 2. MAX2641 Typical Scattering Parameters at $V_{CC} = +3V$, $T_A = +25^{\circ}C$

FREQUENCY (MHz)	S11 MAG	PHASE	S21 MAG	PHASE	S12 MAG	PHASE	S22 MAG	PHASE
1500	0.734	-75.5	4.397	-90.5	0.013	-80.3	0.535	17.7
1600	0.717	-80.3	4.209	-109.8	0.016	-91.9	0.514	8.6
1700	0.695	-85.3	4.193	-131.6	0.018	-116.5	0.513	-0.5
1800	0.678	-90.6	3.876	-150.0	0.021	-128.7	0.510	-10.6
1900	0.661	-96.6	3.801	-173.5	0.023	-150.6	0.493	-21.6
2000	0.646	-102.6	3.456	166.9	0.026	-166.6	0.470	-32.0
2100	0.632	-108.8	3.302	146.4	0.028	171.7	0.431	-43.4
2200	0.620	-114.0	2.981	123.6	0.029	150.7	0.403	-56.1
2300	0.610	-119.4	2.781	105.3	0.033	132.2	0.374	-69.4
2400	0.604	-124.6	2.430	82.9	0.032	111.2	0.338	-86.2
2500	0.603	-128.4	2.118	64.7	0.030	95.7	0.316	-98.3

Table 3. MAX2640 Typical Noise Parameters at $V_{CC} = +3V$, $T_A = +25^\circ C$

FREQUENCY (MHz)	f_{MIN} (dB)	$ \Gamma_{opt} $	Γ_{opt} ANGLE	R_N (Ω)
400	0.66	0.56	21	12.5
500	0.69	0.54	25	11.9
600	0.72	0.51	30	11.3
700	0.75	0.48	35	10.8
800	0.78	0.46	40	10.2
900	0.82	0.43	45	9.7
1000	0.85	0.40	50	9.3
1100	0.89	0.37	56	8.8
1200	0.93	0.35	62	8.3
1300	0.97	0.32	68	7.9
1400	1.01	0.29	77	7.4
1500		0.26	84	7.0

Table 4. MAX2641 Typical Noise Parameters at $V_{CC} = +3V$, $T_A = +25^\circ C$

FREQUENCY (MHz)	f_{MIN} (dB)	$ \Gamma_{opt} $	Γ_{opt} ANGLE	R_N (Ω)
1500	1.02	0.43	44	12.4
1600	1.05	0.40	47	11.8
1700	1.08	0.38	50	11.3
1800	1.10	0.36	54	10.8
1900	1.14	0.32	58	10.3
2000	1.17	0.30	62	9.9
2100	1.20	0.28	66	9.4
2200	1.23	0.25	71	9.0
2300	1.27	0.22	77	8.6
2300	1.30	0.19	82	8.3
2500	1.34	0.17	91	8.0

Layout and Power-Supply Bypassing

A properly designed PCB is essential to any RF/micro-wave circuit. Be sure to use controlled impedance lines on all high-frequency inputs and outputs. The power supply should be bypassed with decoupling capacitors located close to the device V_{CC} pins. For long V_{CC} lines, it may be necessary to add additional decoupling capacitors. These additional capacitors can be located further away from the device package.

Proper grounding of the GND pins is essential. If the PCB uses a topside RF ground, connect it directly to all GND pins. For a board where the ground plane is not on the component side, the best technique is to connect the GND pin to the board with a plated through-hole close to the package.

Pin Configuration

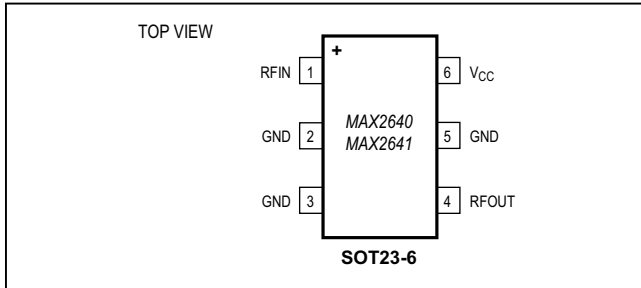

Package Information

For the latest package outline information and land patterns (footprints), go to www.maximintegrated.com/packages. Note that a "+", "#", or "-" in the package code indicates RoHS status only. Package drawings may show a different suffix character, but the drawing pertains to the package regardless of RoHS status.

PACKAGE TYPE	PACKAGE CODE	DOCUMENT NO.	LAND PATTERN NO.
6 SOT23	U6+4	21-0058	90-0175

Revision History

REVISION NUMBER	REVISION DATE	DESCRIPTION	PAGES CHANGED
0	10/98	Initial release	—
1	2/99	Initial release of evaluation kit, added to data sheet	—
2	8/03	Informed customers of ESD sensitive devices	—
3	4/07	Added automotive temperature range	1, 2, 5
4	2/15	Removed automotive reference from data sheet	1

For pricing, delivery, and ordering information, please contact Maxim Direct at 1-888-629-4642, or visit Maxim Integrated's website at www.maximintegrated.com.

Maxim Integrated cannot assume responsibility for use of any circuitry other than circuitry entirely embodied in a Maxim Integrated product. No circuit patent licenses are implied. Maxim Integrated reserves the right to change the circuitry and specifications without notice at any time. The parametric values (min and max limits) shown in the Electrical Characteristics table are guaranteed. Other parametric values quoted in this data sheet are provided for guidance.

Looking for pricing, stock, or lifecycle information?

Click below to explore more details on WIN SOURCE:

 [View MAX2640EUT+ on WIN SOURCE](#)

 [Maxim Integrated Information](#)

Optimize Your Supply Chain with WIN SOURCE Solutions

-  Global Sourcing Solution
-  Obsolete Management
-  Cost Control Management
-  Shortage Management
-  Alternative Solution
-  Excess Inventory Management