



**THE DATASHEET OF
MAX2410EEI+**





Low-Cost RF Up/Downconverter with LNA and PA Driver

MAX2410

General Description

The MAX2410 performs the RF front-end transmit/receive function in time-division-duplex (TDD) communication systems. It operates over a wide frequency range and is optimized for RF frequencies around 1.9GHz. Applications include most popular cordless and PCS standards.

The MAX2410 contains a low-noise amplifier (LNA), a downconverter mixer, a local-oscillator (LO) buffer, an upconverter mixer, and a variable-gain power-amplifier (PA) driver in a low-cost, plastic surface-mount package. The LNA has a 2.4dB (typical) noise figure and a -10dBm input third-order intercept point (IP3). The downconverter mixer has a low 9.8dB noise figure and a 3.3dBm IP3. Image and LO filtering are implemented off-chip for maximum flexibility. The PA driver has 15dB of gain, which can be reduced over a 35dB (typical) range. Power consumption is only 60mW in receive mode or 90mW in transmit mode and drops to less than 0.3µW in shutdown mode.

A similar part, the MAX2411A, features the same functionality as the MAX2410 but offers a differential bidirectional (transmit and receive) IF port. This allows the use of a single IF filter for transmit (TX) and receive (RX). For applications requiring a receive function only, consult the data sheet for the MAX2406, a low-cost downconverter with low-noise amplifier.

Applications

PWT1900	DECT
DCS1800/PCS1900	ISM-Band Transceiver
PHS/PACS	Iridium Handsets

Functional Diagram

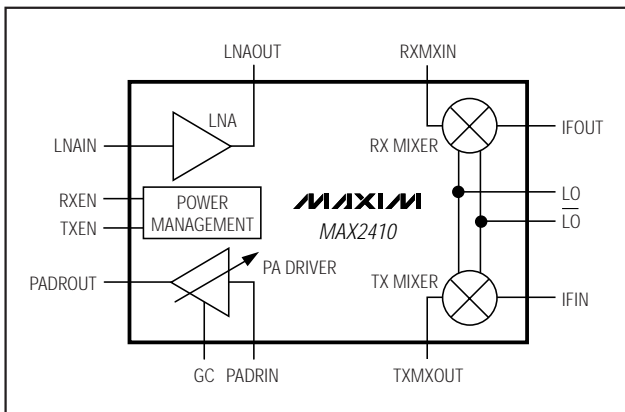

Features

- ♦ **Low-Cost Silicon Bipolar Design**
- ♦ **Integrated Upconvert/Downconvert Function**
- ♦ **Operates from Single +2.7V to +5.5V Supply**
- ♦ **3.2dB Combined Receiver Noise Figure:**
2.4dB (LNA)
9.8dB (Mixer)
- ♦ **Flexible Power-Amplifier Driver:**
18dBm Output Third-Order Intercept (OIP3)
35dB Gain Control Range
- ♦ **LO Buffer for Low LO Drive Level**
- ♦ **Low Power Consumption:**
60mW Receive
90mW Full-Power Transmit
- ♦ **0.3µW Shutdown Mode**
- ♦ **Flexible Power-Down Modes Compatible with MAX2510/MAX2511 IF Transceivers**

Ordering Information

PART	TEMP. RANGE	PIN-PACKAGE
MAX2410EEI	-40°C to +85°C	28 QSOP
MAX2410E/D	-40°C to +85°C	Dice*

*Dice are specified at T_A = +25°C, DC parameters only.

Pin Configuration

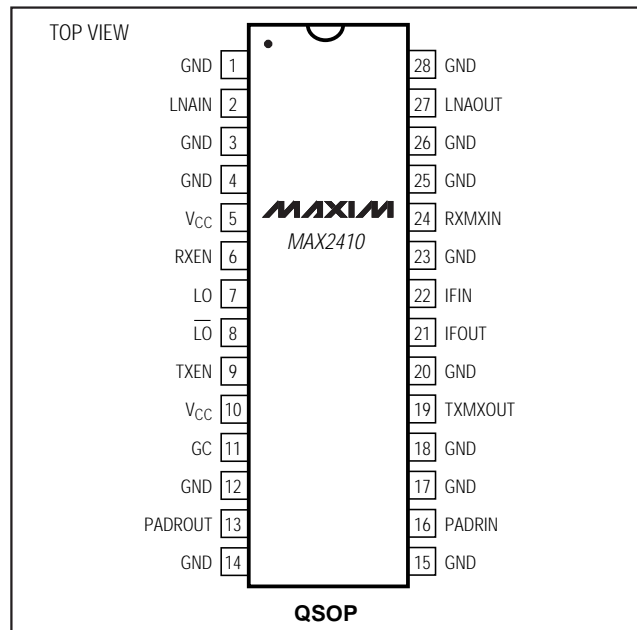

Low-Cost RF Up/Downconverter with LNA and PA Driver

ABSOLUTE MAXIMUM RATINGS

V _{CC} to GND	-0.3V to +6V	Continuous Power Dissipation (T _A = +70°C)	
LNAIN Input Power	+15dBm	QSOP (derate 11mW/°C above +70°C)	909mW
LO, L _O Input Power	+10dBm	Junction Temperature	+150°C
PADRIN Input Power	+10dBm	Operating Temperature Range	-40°C to +85°C
RXMXIN Input Power	+10dBm	Storage Temperature Range	-65°C to +165°C
IFIN Input Power	+10dBm	Lead Temperature (soldering, 10sec)	+300°C
RXEN, TXEN, GC Voltage	-0.3V to (V _{CC} + 0.3V)		

Stresses beyond those listed under "Absolute Maximum Ratings" may cause permanent damage to the device. These are stress ratings only, and functional operation of the device at these or any other conditions beyond those indicated in the operational sections of the specifications is not implied. Exposure to absolute maximum rating conditions for extended periods may affect device reliability.

DC ELECTRICAL CHARACTERISTICS

(V_{CC} = 2.7V to 5.5V, V_{GC} = 3.0V, RXEN = TXEN = 0.6V, IFOUT and PADROUT pulled up to V_{CC} with 50Ω resistors, TXMXOUT pulled up to V_{CC} with 125Ω resistor, LNAOUT pulled up to V_{CC} with 100Ω resistor, all other RF and IF inputs open, T_A = -40°C to +85°C, unless otherwise noted. Typical values are at T_A = +25°C and V_{CC} = 3.0V.)

PARAMETER	CONDITIONS	MIN	TYP	MAX	UNITS
Supply Voltage Range		2.7		5.5	V
Digital Input Voltage High	RXEN, TXEN pins	2.0			V
Digital Input Voltage Low	RXEN, TXEN pins			0.6	V
RXEN Input Bias Current (Note 1)	RXEN = 2V		0.1	1	μA
TXEN Input Bias Current (Note 1)	TXEN = 2V		0.1	1	μA
GC Input Bias Current	GC = 3V, TXEN = 2V		35	46	μA
Supply Current, Receive Mode	RXEN = 2V		20	29.5	mA
Supply Current, Transmit Mode	TXEN = 2V		30	44.5	mA
Supply Current, Standby Mode	RXEN = 2V, TXEN = 2V		160	520	μA
Supply Current, Shutdown Mode	V _{CC} = 3V		0.1	10	μA

AC ELECTRICAL CHARACTERISTICS

(MAX2410 EV kit, V_{CC} = 3.0V, V_{GC} = 2.15V, RXEN = TXEN = low, f_{LO} = 1.5GHz, P_{LO} = -10dBm, f_{LNAIN} = f_{PADRIN} = f_{RXMXIN} = 1.9GHz, P_{LNAIN} = -32dBm, P_{PADRIN} = P_{RXMXIN} = -22dBm, f_{IFIN} = 400MHz, P_{IFIN} = -32dBm. All measurements performed in 50Ω environment. T_A = +25°C, unless otherwise noted.)

PARAMETER	CONDITIONS	MIN	TYP	MAX	UNITS
LOW-NOISE AMPLIFIER (RXEN = High)					
Gain (Note 1)	T _A = +25°C	14.2	16.2	17.4	dB
	T _A = T _{MIN} to T _{MAX}	12.6		19.1	
Noise Figure			2.4		dB
Input IP3	(Note 2)		-10		dBm
Output 1dB Compression			-5		dBm
LO to LNAIN Leakage	RXEN = high or low		-49		dBm
RECEIVE MIXER (RXEN = High)					
Conversion Gain (Note 1)	T _A = +25°C	6.6	8.3	9.8	dB
	T _A = T _{MIN} to T _{MAX}	5.4		10.8	
Noise Figure	Single sideband		9.8		dB
Input IP3	(Note 3)		3.3		dBm
Input 1dB Compression			-8		dBm
IFOUT Frequency	(Notes 1, 4)			450	MHz
Minimum LO Drive Level	(Note 5)		-17		dBm

Low-Cost RF Up/Downconverter with LNA and PA Driver

MAX2410

AC ELECTRICAL CHARACTERISTICS (continued)

(MAX2410 EV kit, $V_{CC} = 3.0V$, $V_{GC} = 2.15V$, $RXEN = TXEN = \text{low}$, $f_{LO} = 1.5GHz$, $P_{LO} = -10dBm$, $f_{LNAIN} = f_{PADRIN} = f_{RXMXIN} = 1.9GHz$, $PLNAIN = -32dBm$, $PPADRIN = PRXMXIN = -22dBm$, $f_{IFIN} = 400MHz$, $PIFIN = -32dBm$. All measurements performed in 50Ω environment. $T_A = +25^\circ C$, unless otherwise noted.)

PARAMETER	CONDITIONS	MIN	TYP	MAX	UNITS
TRANSMIT MIXER (TXEN = high)					
Conversion Gain (Note 1)	$T_A = +25^\circ C$	8.6	10	11.1	dB
	$T_A = T_{MIN}$ to T_{MAX}	7.3		11.8	
Output IP3	(Note 6)		-0.3		dBm
Output 1dB Compression Point			-11.4		dBm
LO Leakage			-52		dBm
Noise Figure	Single sideband		8.2		dB
IFIN Frequency	(Notes 1, 4)			450	MHz
Intermod Spurious Response (Note 7)	$f_{OUT} = 2LO - 2IF = 2.2GHz$		-44		dBc
	$f_{OUT} = 2LO - 3IF = 1.8GHz$		-74		dBc
	$f_{OUT} = 3LO - 6IF = 2.1GHz$		-90		dBc
POWER AMPLIFIER DRIVER (TXEN = high)					
Gain (Note 1)	$T_A = +25^\circ C$	13	15	16.4	dB
	$T_A = T_{MIN}$ to T_{MAX}	12.3		17	
Output IP3	(Note 3)		18		dBm
Output 1dB Compression Point			6.3		dBm
Gain-Control Range			35		dB
Gain-Control Sensitivity	(Note 8)		12		dB/V
LOCAL OSCILLATOR INPUTS (RXEN = TXEN = high)					
Input Relative VSWR Normalized to Standby-Mode Impedance	Receive (TXEN = Low)		1.10		
	Transmit (RXEN = Low)		1.02		
POWER MANAGEMENT (RXEN = TXEN = low)					
Receiver Turn-On Time	(Notes 1, 9)		0.5	2.5	μs
Transmitter Turn-On Time	(Notes 1, 10)		0.3	2.5	μs

Note 1: Guaranteed by design and characterization.

Note 2: Two tones at 1.9GHz and 1.901GHz at -32dBm per tone

Note 3: Two tones at 1.9GHz and 1.901GHz at -22dBm per tone

Note 4: Mixer operation guaranteed to this frequency. For optimum gain, adjust output match. See the *Typical Operating Characteristics* for graphs of IFIN and IFOUT Impedance vs. IF Frequency.

Note 5: At this LO drive level the mixer conversion gain is typically 1dB lower than with -10dBm LO drive.

Note 6: Two tones at 400MHz and 401MHz at -32dBm per tone.

Note 7: Transmit mixer output at -17dBm.

Note 8: Calculated from measurements taken at $V_{GC} = 1.0V$ and $V_{GC} = 1.5V$.

Note 9: Time from RXEN = low to RXEN = high transition until the combined receive gain is within 1dB of its final value. Measured with 47pF blocking capacitors on LNAIN and LNAOUT.

Note 10: Time from TXEN = low to TXEN = high transition until the combined transmit gain is within 1dB of its final value. Measured with 47pF blocking capacitors on PADRIN and PADROUT.

Low-Cost RF Up/Downconverter with LNA and PA Driver

Typical Operating Characteristics

(MAX2410 EV kit, $V_{CC} = 3.0V$, $V_{GC} = 2.15V$, $RXEN = TXEN = \text{low}$, $f_{LO} = 1.5GHz$, $P_{LO} = -10dBm$, $f_{LNAIN} = f_{PADRIN} = f_{RXMXIN} = 1.9GHz$, $PLNAIN = -32dBm$, $PPADRIN = PRXMXIN = -22dBm$, $f_{IFIN} = 400MHz$, $PIFIN = -32dBm$. All measurements performed in 50Ω environment. $T_A = +25^\circ C$, unless otherwise noted. All impedance measurements made directly to pin (no matching network).)

TRANSMIT-MODE SUPPLY CURRENT vs. TEMPERATURE

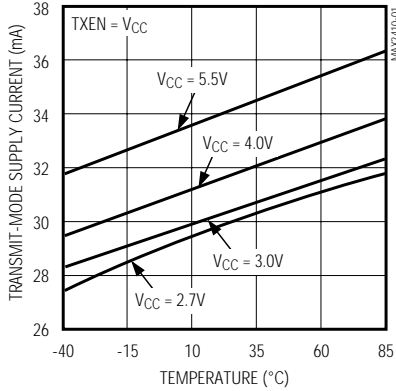

RECEIVE-MODE SUPPLY CURRENT vs. TEMPERATURE

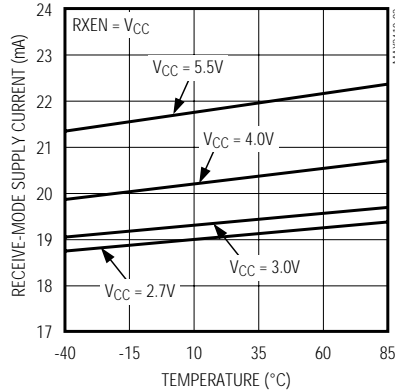

SHUTDOWN SUPPLY CURRENT vs. TEMPERATURE

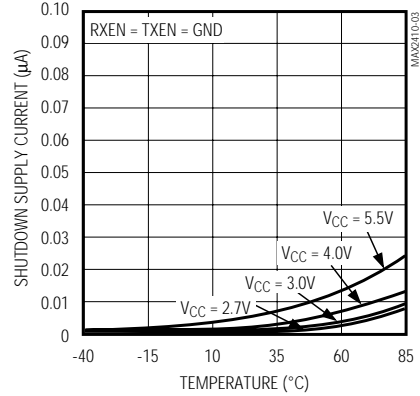

STANDBY SUPPLY CURRENT vs. TEMPERATURE

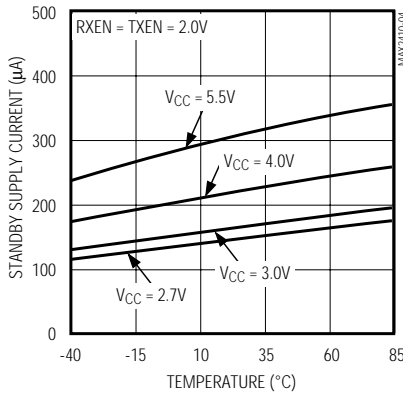

LNA INPUT IMPEDANCE vs. FREQUENCY

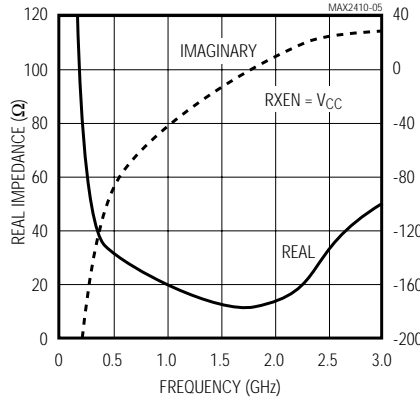

LNA OUTPUT IMPEDANCE vs. FREQUENCY

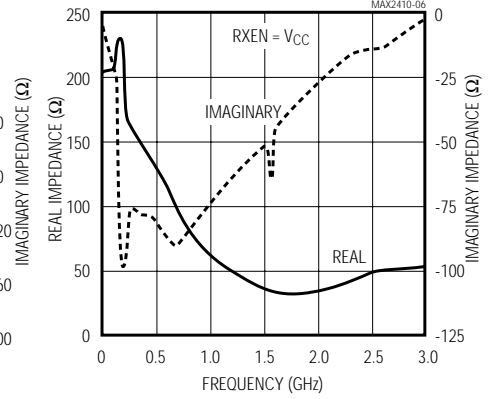

LNA GAIN vs. FREQUENCY

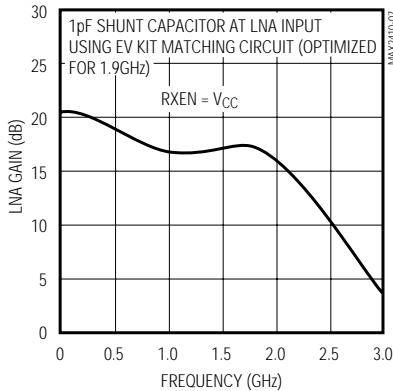

LNA GAIN vs. TEMPERATURE

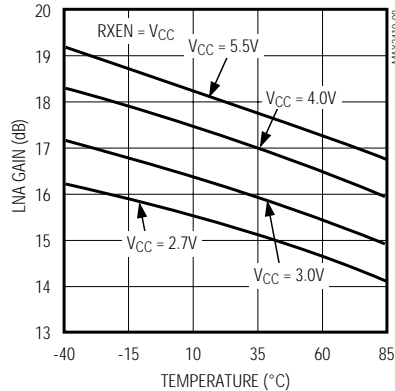

LNA INPUT IP3 vs. TEMPERATURE

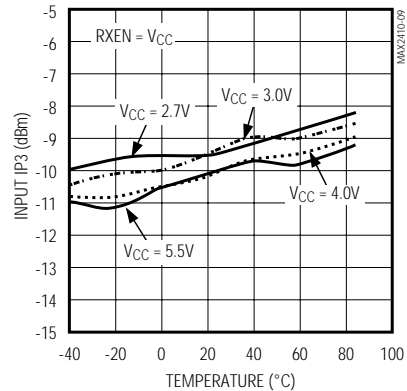

Low-Cost RF Up/Downconverter with LNA and PA Driver

MAX2410

Typical Operating Characteristics (continued)

(MAX2410 EV kit, $V_{CC} = 3.0V$, $V_{GC} = 2.15V$, $RXEN = TXEN = low$, $f_{LO} = 1.5GHz$, $P_{LO} = -10dBm$, $f_{LNAIN} = f_{PADRIN} = f_{RXXMIN} = 1.9GHz$, $P_{LNAIN} = -32dBm$, $P_{PADRIN} = P_{RXXMIN} = -22dBm$, $f_{FIN} = 400MHz$, $P_{FIN} = -32dBm$. All measurements performed in 50Ω environment. $T_A = +25^\circ C$, unless otherwise noted. All impedance measurements made directly to pin (no matching network).)

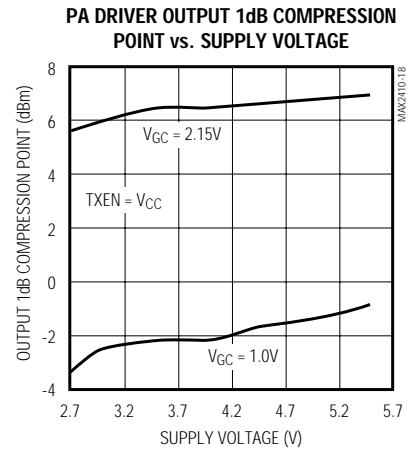
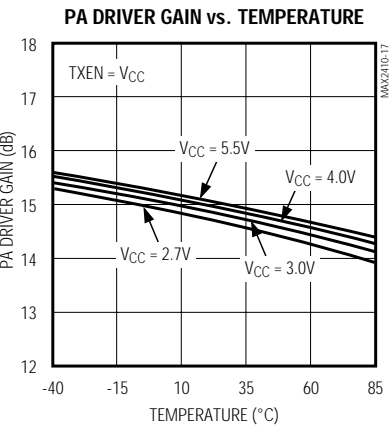
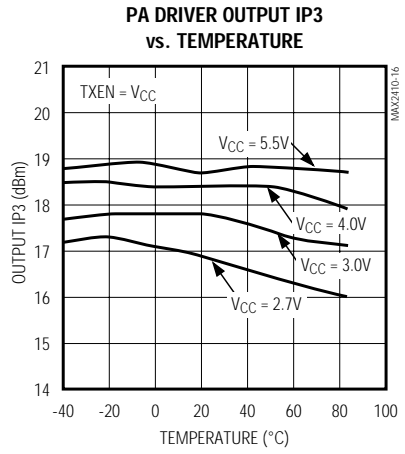
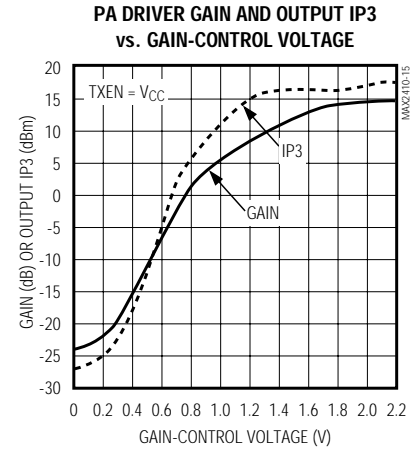
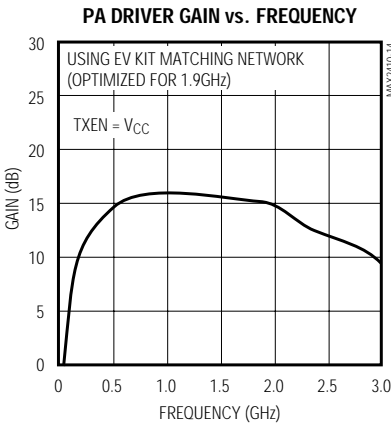
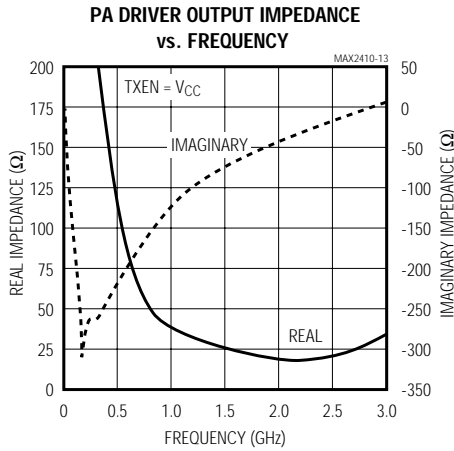
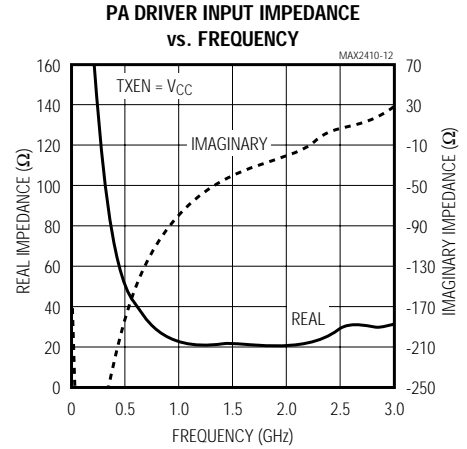
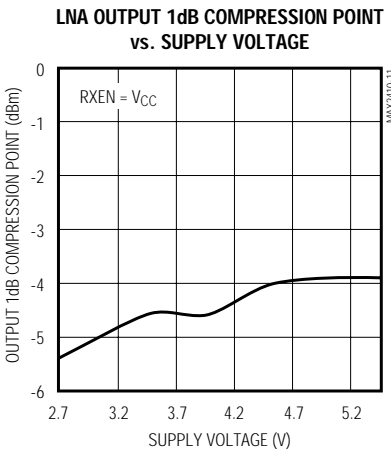
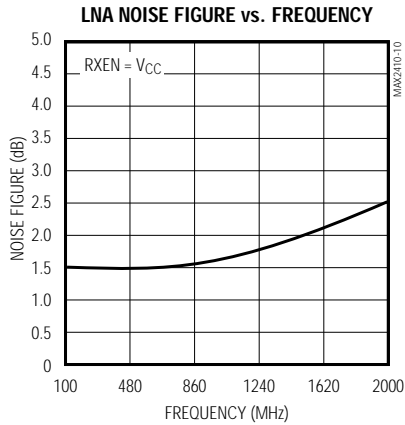

Low-Cost RF Up/Downconverter with LNA and PA Driver

Typical Operating Characteristics (continued)

(MAX2410 EV kit, $V_{CC} = 3.0V$, $V_{GC} = 2.15V$, $RXEN = TXEN = \text{low}$, $f_{LO} = 1.5GHz$, $P_{LO} = -10dBm$, $f_{LNAIN} = f_{PADRIN} = f_{RXMXIN} = 1.9GHz$, $PLNAIN = -32dBm$, $PPADRIN = PRXMXIN = -22dBm$, $f_{IFIN} = 400MHz$, $PIFIN = -32dBm$. All measurements performed in 50Ω environment. $T_A = +25^\circ C$, unless otherwise noted. All impedance measurements made directly to pin (no matching network).)

PA DRIVER NOISE FIGURE vs. FREQUENCY

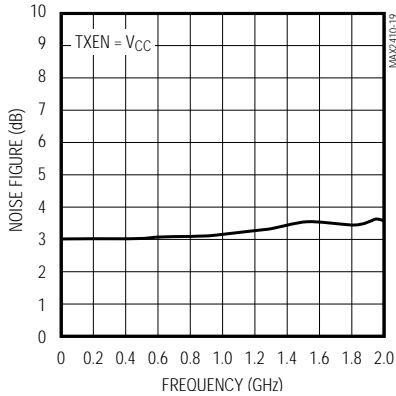

PA DRIVER NOISE FIGURE vs. GAIN-CONTROL VOLTAGE

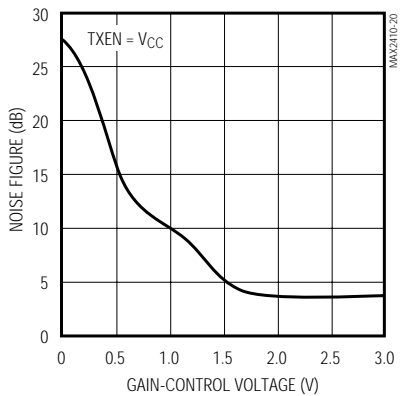

RECEIVE MIXER INPUT IMPEDANCE vs. FREQUENCY

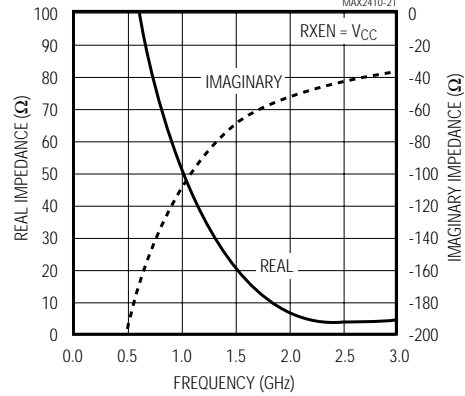

IF OUTPUT IMPEDANCE vs. FREQUENCY

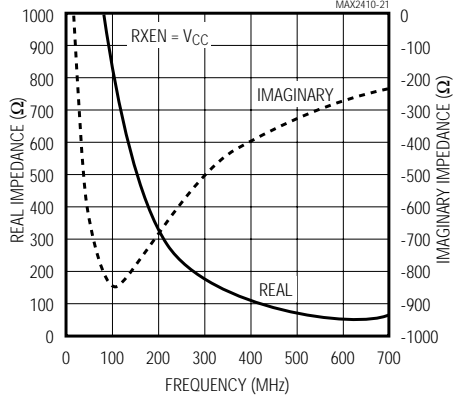

RECEIVE MIXER CONVERSION GAIN vs. TEMPERATURE

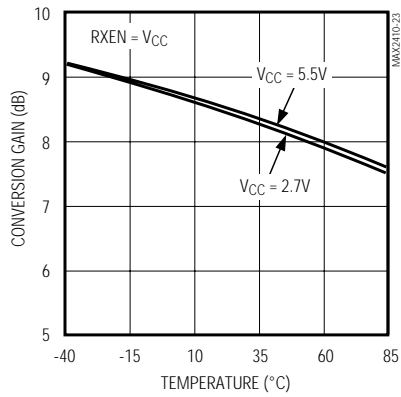

RECEIVE MIXER INPUT IP3 vs. TEMPERATURE

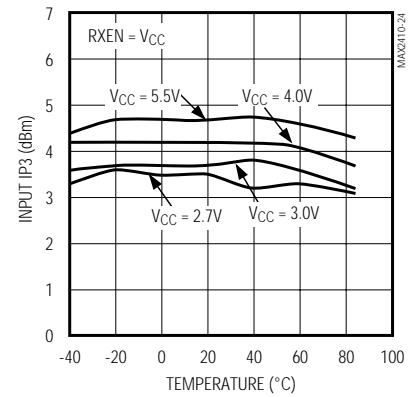

RECEIVE MIXER CONVERSION GAIN vs. RF FREQUENCY

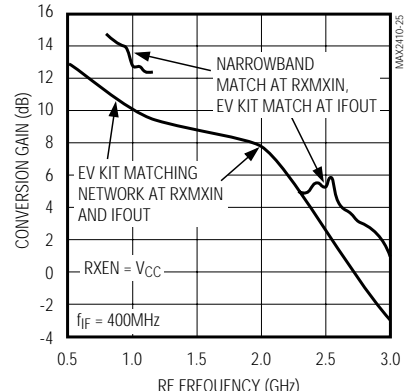

RECEIVE MIXER CONVERSION GAIN AND NOISE FIGURE vs. LO POWER

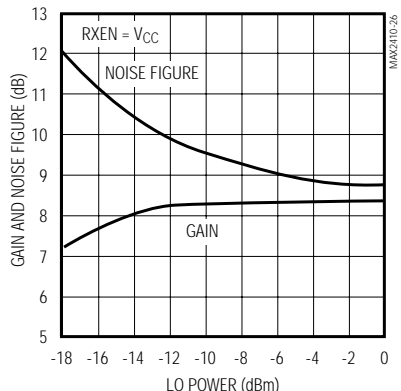

TRANSMIT MIXER OUTPUT IMPEDANCE vs. FREQUENCY

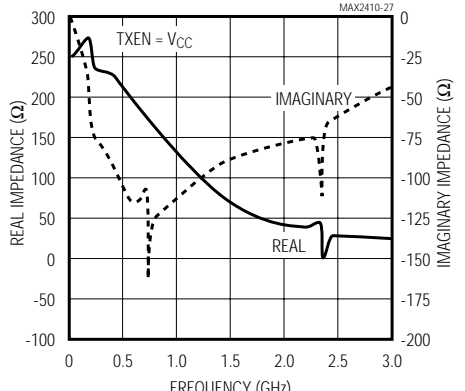

Low-Cost RF Up/Downconverter with LNA and PA Driver

MAX2410

Typical Operating Characteristics (continued)

(MAX2410 EV kit, $V_{CC} = 3.0V$, $V_{GC} = 2.15V$, $RXEN = TXEN = \text{low}$, $f_{LO} = 1.5GHz$, $P_{LO} = -10dBm$, $f_{LNAIN} = f_{PADRIN} = f_{RXMXIN} = 1.9GHz$, $P_{LNAIN} = -32dBm$, $P_{PADRIN} = P_{RXMXIN} = -22dBm$, $f_{IFIN} = 400MHz$, $P_{IFIN} = -32dBm$. All measurements performed in 50Ω environment. $T_A = +25^\circ C$, unless otherwise noted. All impedance measurements made directly to pin (no matching network).)

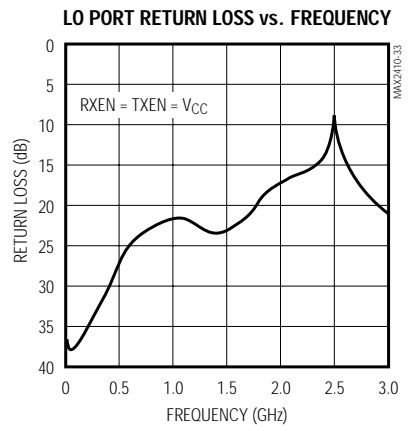
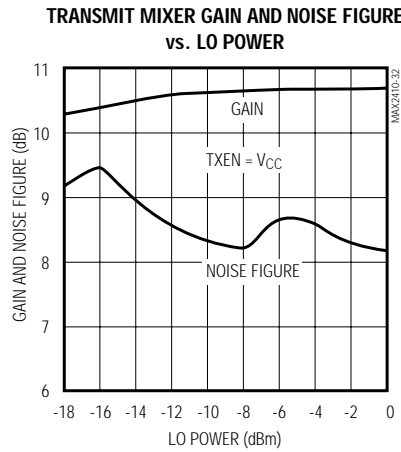
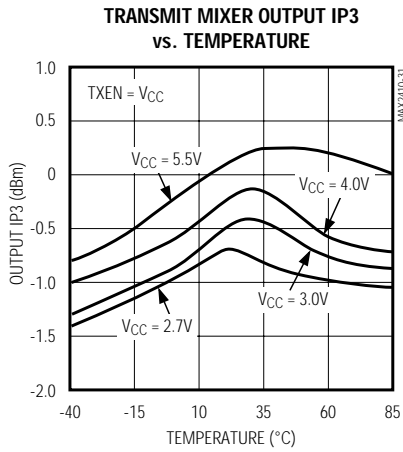
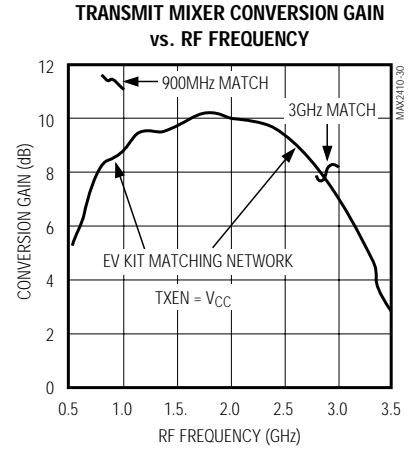
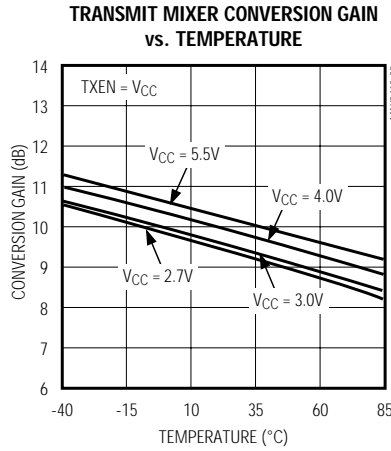
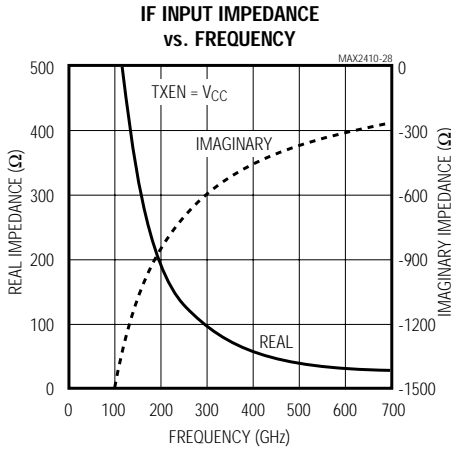

Low-Cost RF Up/Downconverter with LNA and PA Driver

Pin Description

PIN	NAME	FUNCTION
1, 3, 4, 12, 14, 18, 20, 23, 28	GND	Ground. Connect to PC board ground plane with minimal inductance.
2	LNAIN	RF Input to the LNA. AC couple to this pin. At 1.9GHz, LNAIN can be easily matched to 50Ω with one external shunt 1pF capacitor.
5, 10	V _{CC}	Supply Voltage (2.7V to 5.5V). Bypass V _{CC} to GND at each pin with a 47pF capacitor as close to each pin as possible.
6	RXEN	Logic-Level Enable for Receiver Circuitry. A logic high turns on the receiver. When TXEN and RXEN are both at a logic high, the part is placed in standby mode, with a supply current of 160μA (typical). If TXEN and RXEN are both at a logic low, the part is set to shutdown mode, with a supply current of 0.1μA (typical).
7	LO	50Ω Local-Oscillator (LO) Input Port. AC couple to this pin.
8	$\overline{\text{LO}}$	50Ω Inverting Local-Oscillator Input Port. For single-ended operation connect $\overline{\text{LO}}$ directly to GND. If a differential LO signal is available, AC couple the inverted LO signal to this pin.
9	TXEN	Logic-Level Enable for Transmitter Circuitry. A logic high turns on the transmitter. When TXEN and RXEN are both at a logic high, the part is placed in standby mode, with 160μA (typical) supply current. If TXEN and RXEN are both at a logic low, the part is set to shutdown mode, with 0.1μA (typical) supply current.
11	GC	Gain-Control Input for Power-Amplifier Driver. By applying an analog control voltage between 0V and 2.15V, the gain of the PA driver can be adjusted over a 35dB range. Connect to V _{CC} for maximum gain.
13	PADROUT	Power-Amplifier Driver Output. AC couple to this pin. Use external shunt inductor to V _{CC} to match this pin to 50Ω. This also provides DC bias. See the <i>Typical Operating Characteristics</i> for a plot of PADROUT Impedance vs. Frequency.
15, 17	GND	Power-Amplifier Driver Input Ground. Connect to PC board ground plane with minimal inductance.
16	PADRIN	RF Input to Variable-Gain Power-Amplifier Driver. AC couple to this pin. Internally matched to 50Ω. This input typically provides a 2:1 VSWR at 1.9GHz. See the <i>Typical Operating Characteristics</i> for a plot of PADRIN Impedance vs. Frequency.
19	TXMXOUT	RF Output of Transmit Mixer (Upconverter). AC couple to this pin. Use an external shunt inductor to V _{CC} as part of a matching network to 50Ω. This also provides DC bias. See the <i>Typical Operating Characteristics</i> for a plot of TXMXOUT Impedance vs. Frequency.
21	IFOUT	IF Output of Receive Mixer (Downconverter). AC couple to this pin. This output is an open collector and should be pulled up to V _{CC} with an inductor. This inductor can be part of the matching network to the desired IF impedance. Alternatively, a resistor can be placed in parallel to this inductor to set a terminating impedance. See the <i>Typical Operating Circuit</i> for more information.
22	IFIN	IF Input of Transmit Mixer (Upconverter). AC couple to this pin. IFIN presents a high input impedance and typically requires a matching network. See the <i>Typical Operating Characteristics</i> for a plot of IFIN Impedance vs. Frequency.
24	RXMXIN	RF Input to Receive Mixer (Downconverter). AC couple to this pin. This input typically requires a matching network for connecting to an external filter. See the <i>Typical Operating Characteristics</i> for a plot of RXMXIN Impedance vs. Frequency.
25	GND	Receive Mixer Input Ground. Connect to PC board ground plane with minimal inductance.
26	GND	LNA Output Ground. Connect to PC board ground plane with minimal inductance.
27	LNAOUT	LNA Output. AC couple to this pin. This output typically provides a VSWR of better than 2:1 at frequencies from 1.7GHz to 3GHz with no external matching components. At other frequencies, a matching network may be required to match this pin to an external filter. Consult the <i>Typical Operating Characteristics</i> for a plot of LNA Output Impedance vs. Frequency.

Low-Cost RF Up/Downconverter with LNA and PA Driver

Typical Operating Circuit

MAX2410

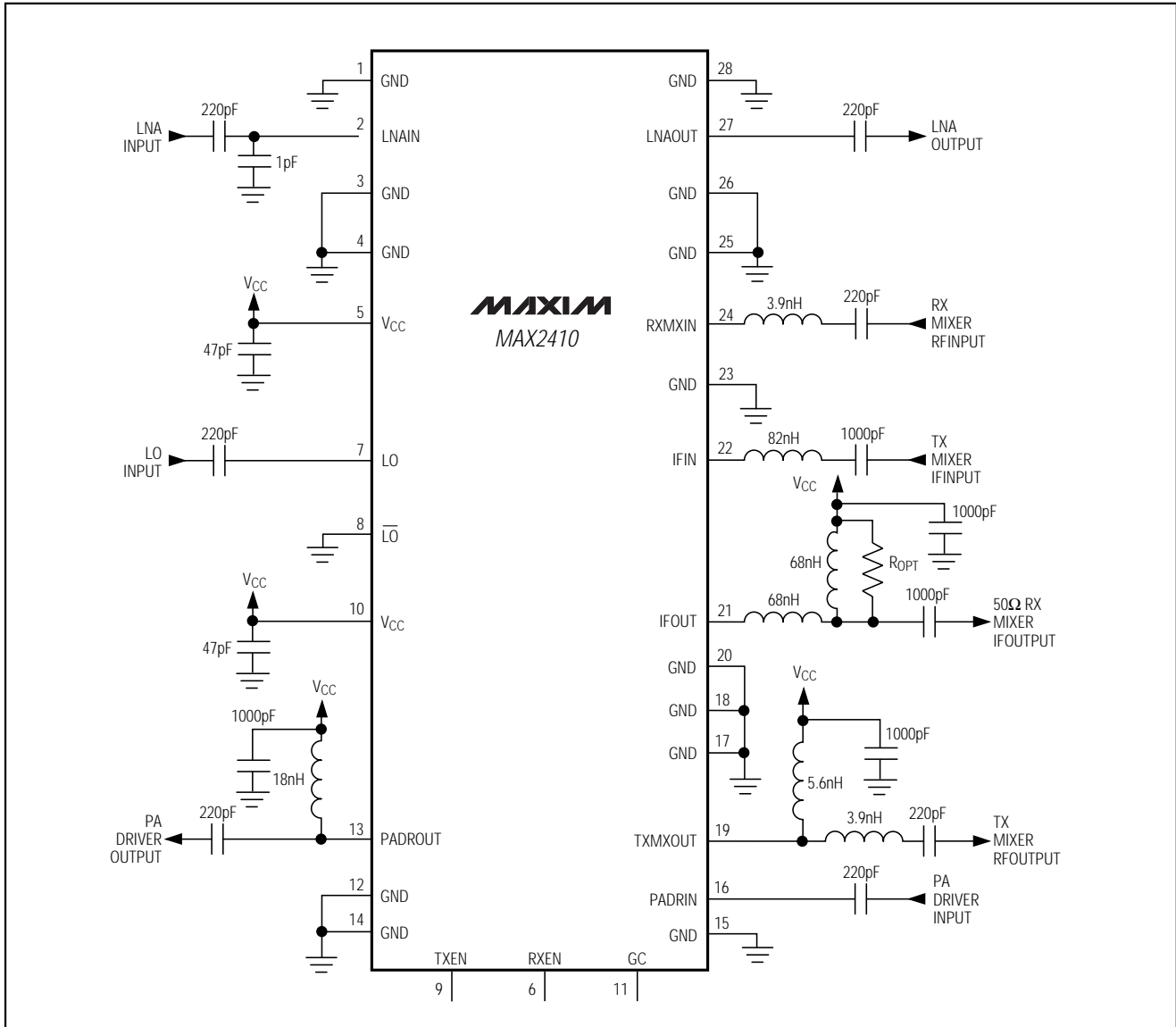

Detailed Description

The MAX2410 consists of five major components: a transmit mixer, a variable-gain power-amplifier (PA) driver, a low-noise amplifier (LNA), a receive mixer, and power-management section.

The following sections describe each block in the MAX2410 Functional Diagram.

Low-Noise Amplifier (LNA)

The LNA is a wideband, single-ended cascode amplifier that can be used over a wide range of frequencies (refer to the LNA Gain vs. Frequency graph in the *Typical Operating Characteristics*). Its port impedances are optimized for operation around 1.9GHz, requiring only a 1pF shunt capacitor at the LNA input for a VSWR of better than 2:1 and a noise figure of 2.4dB. As with every LNA, the input match can be traded off for better noise figure.

Low-Cost RF Up/Downconverter with LNA and PA Driver

PA Driver

The PA driver typically has 15dB of gain, which is adjustable over a 35dB range via the GC pin. At full gain, the PA driver has a noise figure of 3.5dB at 1.9GHz.

For input and output matching information, refer to the *Typical Operating Characteristics* for plots of PA Driver Input and Output Impedance vs. Frequency.

Receive Mixer

The receive mixer is a wideband, double-balanced design with excellent noise figure and linearity. The inputs to the mixer are the RF signal at the RXMXIN pin and the LO inputs at LO and $\overline{\text{LO}}$. The downconverted output signal appears at the IFOUT port. The conversion gain of the receive mixer is typically 8.3dB with a noise figure of 9.8dB.

RF Input

The RXMXIN input is typically connected to the LNA output through an off-chip filter. This input is externally matched to 50 Ω . See the *Typical Operating Circuit* for an example matching network and the RXMXIN Impedance vs. Frequency graph in the *Typical Operating Characteristics*.

Local-Oscillator Inputs

The LO and $\overline{\text{LO}}$ pins are internally terminated with 50 Ω on-chip resistors. AC couple the LO signal to these pins. If a single-ended LO source is used, connect $\overline{\text{LO}}$ directly to ground.

IF Output Port

The MAX2410's receive mixer output appears at the IFOUT pin, an open-collector output that requires an external pull-up inductor to V_{CC}. This inductor can be part of a matching network to the desired IF impedance. Alternatively, a resistor can be placed in parallel with the pull-up inductor to set a terminating impedance.

The MAX2411A, a similar part to the MAX2410, has the same functionality as the MAX2410 but offers a differential, bidirectional (transmit and receive) IF port. This allows sharing of TX and RX IF filters, which for some applications provides a lower cost, smaller solution.

Transmit Mixer

The transmit mixer takes an IF signal at the IFIN pin and upconverts it to an RF frequency at the TXMXOUT pin. The conversion gain is typically 10dB and the output 1dB compression point is typically -11.4dBm at 1.9GHz.

RF Output

The transmit mixer output appears on the TXMXOUT pin. It is an open-collector output that requires an external pull-up inductor to V_{CC} for DC biasing, which can be part of an impedance-matching network. Consult the *Typical Operating Characteristics* for a plot of TXMXOUT Impedance vs Frequency.

IF Input

The IFIN pin is a self-biasing input that must be AC-coupled to the IF source. Refer to the *Typical Operating Characteristics* for plots of Input and Output Impedance vs. Frequency.

Local-Oscillator Inputs

The LO and $\overline{\text{LO}}$ pins are terminated with 50 Ω on-chip resistors. AC couple the LO signal to these pins. If a single-ended LO source is used, connect $\overline{\text{LO}}$ directly to GND.

Advanced System Power Management

RXEN and TXEN are the two separate power-control inputs for the receiver and the transmitter. If both inputs are at logic 0, the part enters shutdown mode and the supply current drops below 1 μ A. When one input is brought to a logic 1, the corresponding function is enabled. If RXEN and TXEN are both set to logic 1, the part enters standby mode as described in the *Standby Mode* section. Table 1 summarizes these operating modes.

Power-down is guaranteed with a control voltage at or below 0.6V. The power-down function is designed to reduce the total power consumption to less than 1 μ A in less than 2.5 μ s. Complete power-up will happen in the same amount of time.

Table 1. Advanced System Power-Management Functions

RXEN	TXEN	FUNCTION
0	0	Shutdown
0	1	Transmit
1	0	Receive
1	1	Standby Mode

Low-Cost RF Up/Downconverter with LNA and PA Driver

Standby Mode

When the TXEN and RXEN pins are both set to logic 1, all functions are disabled and the supply current drops to 160µA (typical). This mode is called standby, and it corresponds to a standby mode on the compatible IF transceiver chips MAX2510 and MAX2511.

Applications Information

Extended Frequency Range

The MAX2410 has been characterized at 1.9GHz for use in PCS-band applications; however, it operates over a much wider frequency range. The LNA gain and noise figure, as well as mixer conversion gain, are plotted over a wide frequency range in the *Typical Operating Characteristics*. When operating the device at RF frequencies other than those specified in the *AC Electrical Characteristics* table, it may be necessary to design or alter the matching networks on the RF ports. If the IF frequency is different than that specified in the *AC Electrical Characteristics* table, the IFIN and IFOUT matching networks must be altered. The *Typical Operating Characteristics* provide Port Impedance Data

vs. Frequency on all RF and IF pins for use in designing matching networks. The LO port (LO and $\overline{\text{LO}}$) is internally terminated with 50Ω resistors and provides a VSWR of approximately 1.2:1 to 2GHz and 2:1 up to 3GHz.

Layout Issues

A properly designed PC board is an essential part of any RF/microwave circuit. Be sure to use controlled impedance lines on all high-frequency inputs and outputs. Use low-inductance connections to ground on all GND pins, and place decoupling capacitors close to all VCC connections.

For the power supplies, a star topology works well. In a star topology, each VCC node in the circuit has its own path to the central VCC, and its own decoupling capacitor which provides a low impedance at the RF frequency of interest. The central VCC node has a large decoupling capacitor as well, to provide good isolation between the different sections of the MAX2410. The MAX2410 EV kit layout can be used as a guide to integrating the MAX2410 into your design.

Typical Application Block Diagram

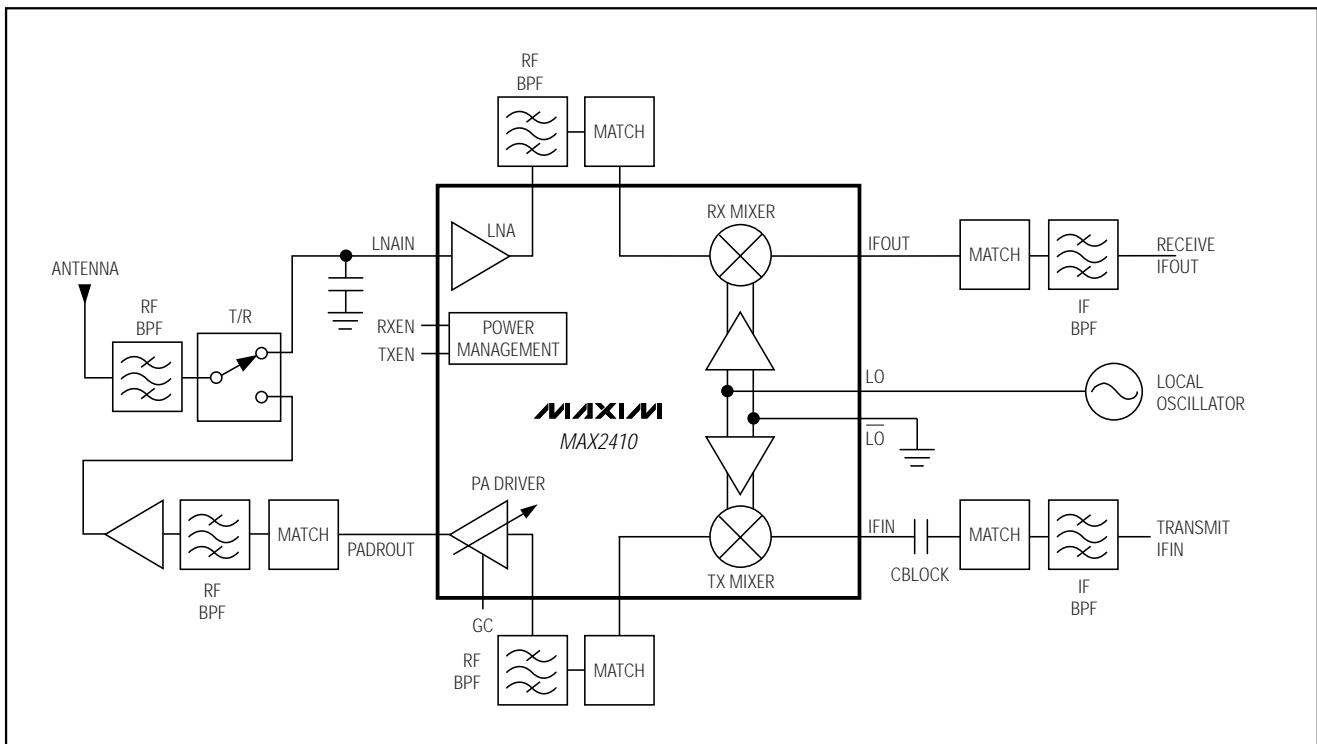

Low-Cost RF Up/Downconverter with LNA and PA Driver

Package Information

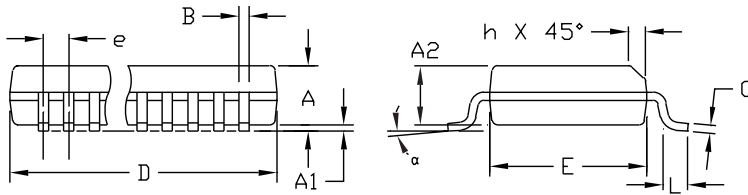
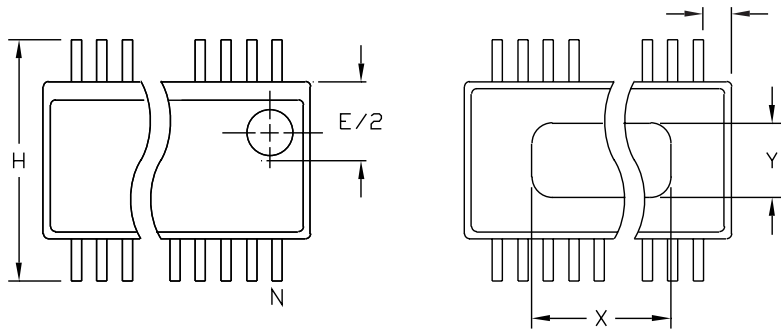

NOTES:

1. D & E DO NOT INCLUDE MOLD FLASH OR PROTRUSIONS
2. MOLD FLASH OR PROTRUSIONS NOT TO EXCEED .006" PER SIDE.
3. HEAT SLUG DIMENSIONS X AND Y APPLY ONLY TO 16 AND 28 LEAD POWER-QSOP PACKAGES.
4. CONTROLLING DIMENSIONS: INCHES.

DIM	INCHES		MILLIMETERS	
	MIN	MAX	MIN	MAX
A	.061	.068	1.55	1.73
A1	.004	.0098	0.102	0.249
A2	.055	.061	1.40	1.55
B	.008	.012	0.20	0.31
C	.0075	.0098	0.191	0.249
D	SEE VARIATIONS			
E	.150	.157	3.81	3.99
e	.025 BSC		0.635 BSC	
H	.230	.244	5.84	6.20
h	.010	.016	0.25	0.41
L	.016	.035	0.41	0.89
N	SEE VARIATIONS			
X	SEE VARIATIONS			
Y	.071	.087	1.803	2.209
α	0°	8°	0°	8°

VARIATIONS:

DIM	INCHES		MILLIMETERS		N
	MIN	MAX	MIN	MAX	
D	.189	.196	4.80	4.98	16 AA
S	.0020	.0070	0.05	0.18	
X	.107	.123	2.72	3.12	
D	.337	.344	8.56	8.74	20 AB
S	.0500	.0550	1.270	1.397	
D	.337	.344	8.56	8.74	24 AC
S	.0250	.0300	0.635	0.762	
D	.386	.393	9.80	9.98	28 AD
S	.0250	.0300	0.635	0.762	
X	.271	.287	6.88	7.29	

MAXIM
 PROPRIETARY INFORMATION
 TITLE
 PACKAGE OUTLINE, QSOP, .150", .025" LEAD PITCH
 APPROVAL DOCUMENT CONTROL NO. REV B 1/1
 21-0055

QSOP-EPS

Looking for pricing, stock, or lifecycle information?

Click below to explore more details on WIN SOURCE:

- ⊖ [View MAX2410EEI+ on WIN SOURCE](#)
- ⊖ [Maxim Integrated Information](#)

Optimize Your Supply Chain with WIN SOURCE Solutions

- ✓ Global Sourcing Solution
- ✓ Obsolete Management
- ✓ Cost Control Management
- ✓ Shortage Management
- ✓ Alternative Solution
- ✓ Excess Inventory Management