



**THE DATASHEET OF  
MAX16025TE+**



# Dual-/Triple-/Quad-Voltage, Capacitor-Adjustable, Sequencing/Supervisory Circuits

## General Description

The MAX16025–MAX16030 are dual-/triple-/quad-voltage monitors and sequencers that are offered in a small TQFN package. These devices offer enormous design flexibility as they allow fixed and adjustable thresholds to be selected through logic inputs and provide sequence timing through small external capacitors. These versatile devices are ideal for use in a wide variety of multivoltage applications.

As the voltage at each monitored input exceeds its respective threshold, its corresponding output goes high after a propagation delay or a capacitor-set time delay. When a voltage falls below its threshold, its respective output goes low after a propagation delay. Each detector circuit also includes its own enable input, allowing the power-good outputs to be shut off independently. The independent output for each detector is available with push-pull or open-drain configuration with the open-drain version capable of supporting voltages up to 28V, thereby allowing them to interface to shutdown and enable inputs of various DC-DC regulators. Each detector can operate independently as four separate supervisory circuits or can be daisy-chained to provide controlled power-supply sequencing.

The MAX16025–MAX16030 also include a reset function that deasserts only after all of the independently monitored voltages exceed their threshold. The reset timeout is internally fixed or can be adjusted externally. These devices are offered in a 4mm x 4mm TQFN package and are fully specified from -40°C to +125°C.

## Applications

Multivoltage Systems  
DC-DC Supplies  
Servers/Workstations  
Storage Systems  
Networking/Telecommunication Equipment

## Selector Guide

PART	MONITORED VOLTAGES	INDEPENDENT OUTPUTS	RESET OUTPUT
MAX16025	2	2 (Open-drain)	Open-drain
MAX16026	2	2 (Push-pull)	Push-pull
MAX16027	3	3 (Open-drain)	Open-drain
MAX16028	3	3 (Push-pull)	Push-pull
MAX16029	4	4 (Open-drain)	Open-drain
MAX16030	4	4 (Push-pull)	Push-pull

## Features

- ◆ 2.2V to 28V Operating Voltage Range
- ◆ Fixed Thresholds for 3.3V, 2.5V, 1.8V, 1.5V, and 1.2V Systems
- ◆ 1.5% Accurate Adjustable Threshold Monitors Voltages Down to 0.5V
- ◆ 2.7% Accurate Fixed Thresholds Over Temperature
- ◆ Fixed (140ms min)/Capacitor-Adjustable Delay Timing
- ◆ Independent Open-Drain/Push-Pull Outputs
- ◆ Enable Inputs for Each Monitored Voltage
- ◆ 9 Logic-Selectable Threshold Options
- ◆ Manual Reset and Tolerance Select (5%/10%) Inputs
- ◆ Small, 4mm x 4mm TQFN Package
- ◆ Fully Specified from -40°C to +125°C

## Ordering Information

PART*	TEMP RANGE	PIN-PACKAGE	PKG CODE
MAX16025TE+	-40°C to +125°C	16 TQFN	T1644-4
MAX16026TE+	-40°C to +125°C	16 TQFN	T1644-4
MAX16027TP+	-40°C to +125°C	20 TQFN	T2044-3
MAX16028TP+	-40°C to +125°C	20 TQFN	T2044-3
MAX16029TG+	-40°C to +125°C	24 TQFN	T2444-4
MAX16030TG+	-40°C to +125°C	24 TQFN	T2444-4

+ Denotes lead-free package.

\*For tape and reel, add a "T" after the "+." All tape and reel orders are available in 2.5k increments.

## Pin Configurations

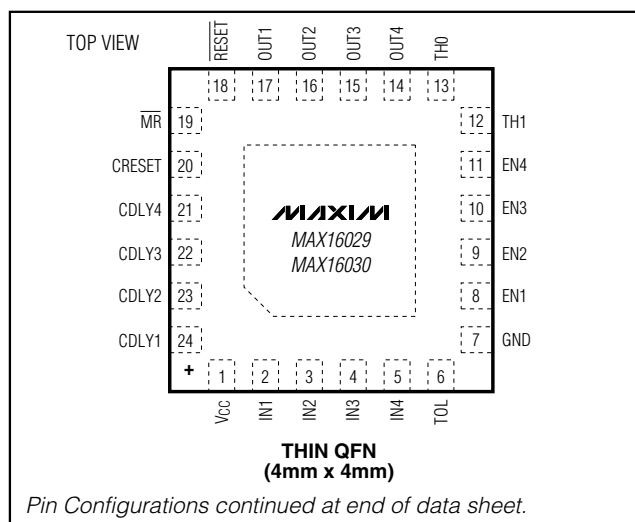

# Dual-/Triple-/Quad-Voltage, Capacitor-Adjustable, Sequencing/Supervisory Circuits

## ABSOLUTE MAXIMUM RATINGS

(All voltages referenced to GND.)

V <sub>CC</sub> .....	-0.3V to +30V	CRESET .....	-0.3V to (V <sub>CC</sub> + 0.3V)
EN1-EN4 .....	-0.3V to (V <sub>CC</sub> + 0.3V)	Input/Output Current (all pins).....	±20mA
OUT1-OUT4 (push-pull).....	-0.3V to (V <sub>CC</sub> + 0.3V)	Continuous Power Dissipation (T <sub>A</sub> = +70°C)	
OUT1-OUT4 (open-drain).....	-0.3V to +30V	16-Pin TQFN (derate 25mW/°C above +70°C) .....	2000mW
RESET (push-pull) .....	-0.3V to (V <sub>CC</sub> + 0.3V)	20-Pin TQFN (derate 25.6mW/°C above +70°C) .....	2051mW
RESET (open-drain) .....	-0.3V to 30V	24-Pin TQFN (derate 27.8mW/°C above +70°C) .....	2222mW
IN1-IN4.....	-0.3V to (V <sub>CC</sub> + 0.3V)	Operating Temperature Range .....	-40°C to +125°C
MR, TOL, TH1, TH0 .....	-0.3V to (V <sub>CC</sub> + 0.3V)	Storage Temperature Range .....	-65°C to +150°C
CDLY1-CDLY4.....	-0.3V to +6V	Junction Temperature .....	+150°C
		Lead Temperature (soldering, 10s) .....	+300°C

Stresses beyond those listed under "Absolute Maximum Ratings" may cause permanent damage to the device. These are stress ratings only, and functional operation of the device at these or any other conditions beyond those indicated in the operational sections of the specifications is not implied. Exposure to absolute maximum rating conditions for extended periods may affect device reliability.

## ELECTRICAL CHARACTERISTICS

(V<sub>CC</sub> = 2.2V to 28V, T<sub>A</sub> = -40°C to +125°C, unless otherwise specified. Typical values are at V<sub>CC</sub> = 3.3V and T<sub>A</sub> = +25°C.) (Note 1)

PARAMETER	SYMBOL	CONDITIONS	MIN	TYP	MAX	UNITS
<b>SUPPLY</b>						
Operating Voltage Range	V <sub>CC</sub>	(Note 2)	2.2		28.0	V
Undervoltage Lockout	UVLO	(Note 2)	1.8	1.9	2.0	V
Undervoltage-Lockout Hysteresis	UVLO <sub>HYST</sub>	V <sub>CC</sub> falling		50		mV
V <sub>CC</sub> Supply Current	I <sub>CC</sub>	All OUT <sub>n</sub> and RESET at logic-high (IN <sub>n</sub> current excluded)	V <sub>CC</sub> = 3.3V	40	75	μA
			V <sub>CC</sub> = 12V	47	75	
			V <sub>CC</sub> = 28V	52	80	
<b>INPUTS (IN<sub>n</sub>)</b>						
IN <sub>n</sub> Thresholds (IN <sub>n</sub> Falling)	V <sub>TH</sub>	3.3V threshold, TOL = GND	2.970	3.052	3.135	V
		3.3V threshold, TOL = V <sub>CC</sub>	2.805	2.888	2.970	
		2.5V threshold, TOL = GND	2.250	2.313	2.375	
		2.5V threshold, TOL = V <sub>CC</sub>	2.125	2.187	2.250	
		1.8V threshold, TOL = GND	1.620	1.665	1.710	
		1.8V threshold, TOL = V <sub>CC</sub>	1.530	1.575	1.620	
		1.5V threshold, TOL = GND	1.350	1.387	1.425	
		1.5V threshold, TOL = V <sub>CC</sub>	1.275	1.312	1.350	
		1.2V threshold, TOL = GND	1.080	1.110	1.140	
		1.2V threshold, TOL = V <sub>CC</sub>	1.020	1.050	1.080	
Adjustable Threshold (IN <sub>n</sub> Falling)	V <sub>TH</sub>	TOL = GND	0.492	0.5	0.508	V
		TOL = V <sub>CC</sub>	0.463	0.472	0.481	
IN <sub>n</sub> Hysteresis (IN <sub>n</sub> Rising)	V <sub>HYST</sub>			0.5		%
IN <sub>n</sub> Input Resistance		Fixed threshold	500	918		kΩ
IN <sub>n</sub> Input Current	I <sub>L</sub>	Adjustable threshold only (V <sub>IN<sub>n</sub></sub> = 1V)	-100		+100	nA

# Dual-/Triple-/Quad-Voltage, Capacitor-Adjustable, Sequencing/Supervisory Circuits

MAX16025-MAX16030

## ELECTRICAL CHARACTERISTICS (continued)

( $V_{CC} = 2.2V$  to  $28V$ ,  $T_A = -40^\circ C$  to  $+125^\circ C$ , unless otherwise specified. Typical values are at  $V_{CC} = 3.3V$  and  $T_A = +25^\circ C$ .) (Note 1)

PARAMETER	SYMBOL	CONDITIONS	MIN	TYP	MAX	UNITS
<b>CRESET AND CDLY_</b>						
CRESET Threshold	$V_{TH-RESET}$	CRESET rising, $V_{CC} = 3.3V$	0.465	0.5	0.535	V
CRESET Charge Current	$I_{CH-RESET}$	$V_{CC} = 3.3V$	380	500	620	nA
CDLY_ Threshold	$V_{TH-CDLY}$	CDLY_ rising, $V_{CC} = 3.3V$	0.95	1	1.05	V
CDLY_ Charge Current	$I_{CH-CDLY}$	$V_{CC} = 3.3V$	200	250	300	nA
<b>DIGITAL LOGIC INPUTS (<math>EN_</math>, <math>\overline{MR}</math>, TOL, TH1, TH0)</b>						
Input Low Voltage	$V_{IL}$				0.4	V
Input High Voltage	$V_{IH}$		1.4			V
TH1, TH0 Logic-Input Floating				0.6		V
TOL, TH1, TH0 Logic-Input Current		$V_{TOL}, V_{TH1}, V_{TH0} = GND$ or $V_{CC}$	-1		+1	$\mu A$
$EN_$ Input Leakage Current		$V_{EN_} = V_{CC}$ or $GND$	-100		+100	nA
$\overline{MR}$ Internal Pullup Current		$V_{CC} = 3.3V$	250	535	820	nA
<b>OUTPUTS (<math>OUT_</math>, <math>\overline{RESET}</math>)</b>						
Output Low Voltage (Open-Drain or Push-Pull)	$V_{OL}$	$V_{CC} \geq 1.2V, I_{SINK} = 90\mu A$			0.3	V
		$V_{CC} \geq 2.25V, I_{SINK} = 0.5mA$			0.3	
		$V_{CC} \geq 4.5V, I_{SINK} = 1mA$			0.35	
Output High Voltage (Push-Pull)	$V_{OH}$	$V_{CC} \geq 3V, I_{SOURCE} = 500\mu A$	$0.8 \times V_{CC}$			V
		$V_{CC} \geq 4.5V, I_{SOURCE} = 800\mu A$	$0.8 \times V_{CC}$			
Output Leakage Current (Open-Drain)	$I_{LKG}$	Output not asserted low, $V_{OUT} = 28V$			1	$\mu A$
Reset Timeout Period	$t_{RP}$	CRESET = $V_{CC}$ , $V_{CC} = 3.3V$	140	190	260	ms
		CRESET open		0.030		
<b>TIMING</b>						
$IN_$ to $OUT_$ Propagation Delay	$t_{DELAY+}$	$IN_$ rising, CDLY_ open		35		$\mu s$
	$t_{DELAY-}$	$IN_$ falling, CDLY_ open		20		
$IN_$ to $\overline{RESET}$ Propagation Delay	$t_{RST-DELAY}$	$IN_$ falling		35		$\mu s$
$\overline{MR}$ Minimum Input Pulse Width		(Note 3)	2			$\mu s$
$EN_$ or $\overline{MR}$ Glitch Rejection				280		ns
$EN_$ to $OUT_$ Delay	$t_{OFF}$	From device enabled to device disabled		3		$\mu s$
	$t_{ON}$	From device disabled to device enabled (CDLY_ open)		30		
$\overline{MR}$ to $\overline{RESET}$ Delay		$\overline{MR}$ falling		3		$\mu s$

**Note 1:** Devices are production tested at  $T_A = +25^\circ C$ . Limits over temperature are guaranteed by design.

**Note 2:** Operating below the UVLO causes all outputs to go low. The outputs are guaranteed to be in the correct state for  $V_{CC}$  down to 1.2V.

**Note 3:** In order to guarantee an assertion, the minimum input pulse width must be greater than  $2\mu s$ .

# Dual-/Triple-/Quad-Voltage, Capacitor-Adjustable, Sequencing/Supervisory Circuits

## Typical Operating Characteristics

( $V_{CC} = 3.3V$ ,  $T_A = +25^\circ C$ , unless otherwise noted.)

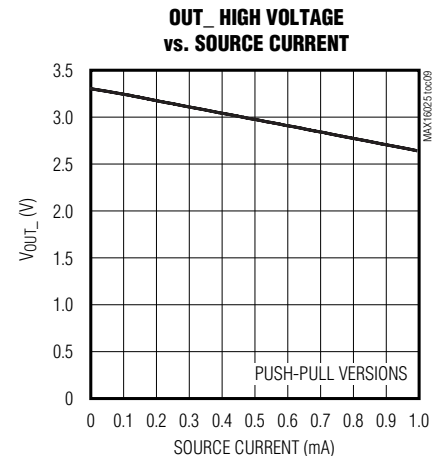
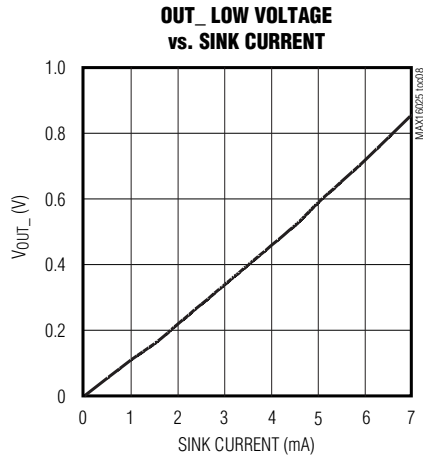
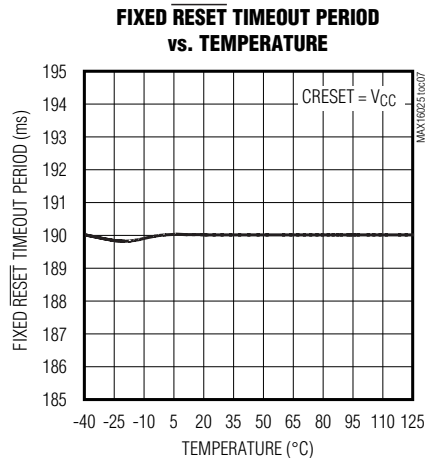
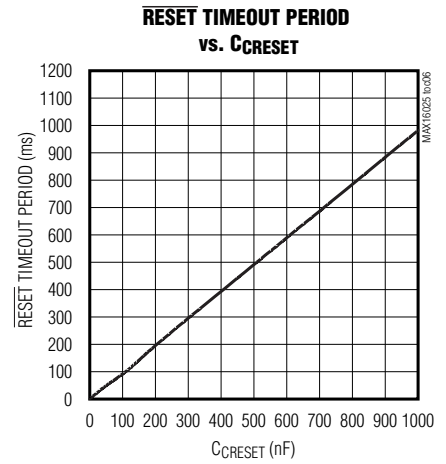
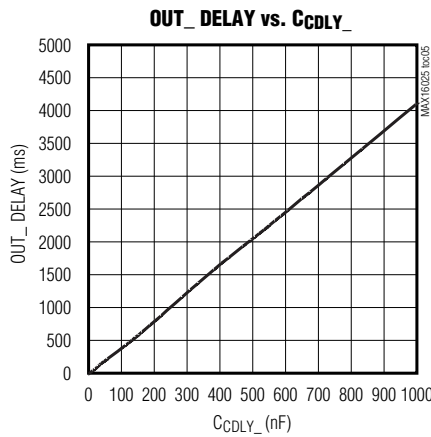
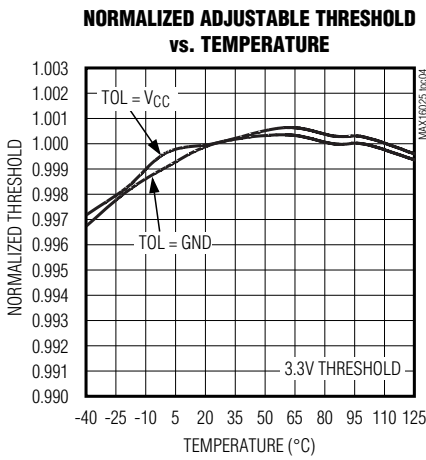
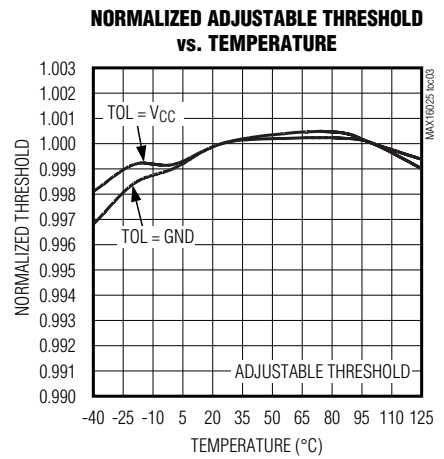
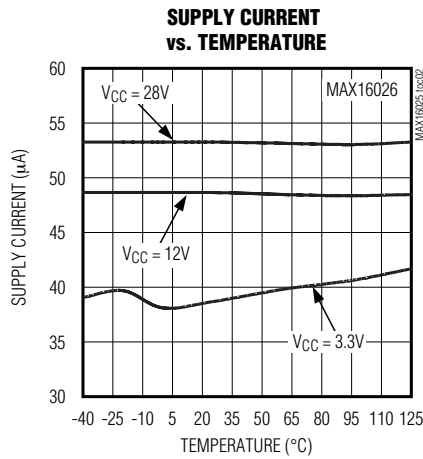
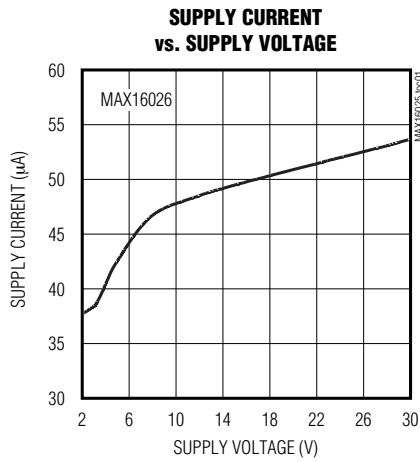

# Dual-/Triple-/Quad-Voltage, Capacitor-Adjustable, Sequencing/Supervisory Circuits

## Typical Operating Characteristics (continued)

( $V_{CC} = 3.3V$ ,  $T_A = +25^\circ C$ , unless otherwise noted.)

MAX16025-MAX16030

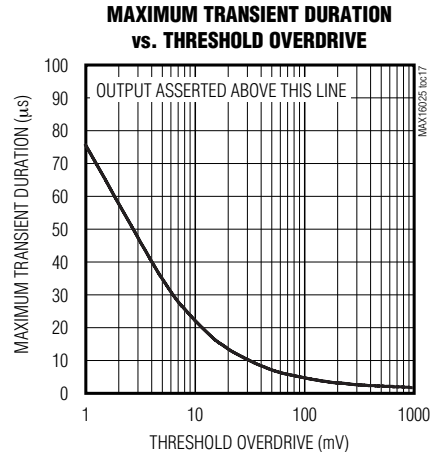
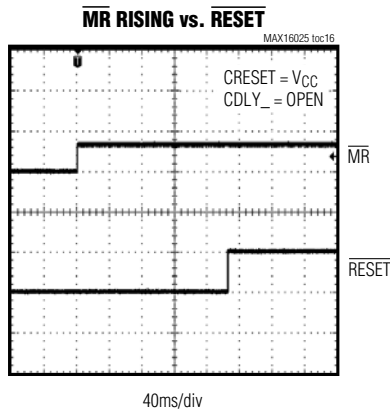
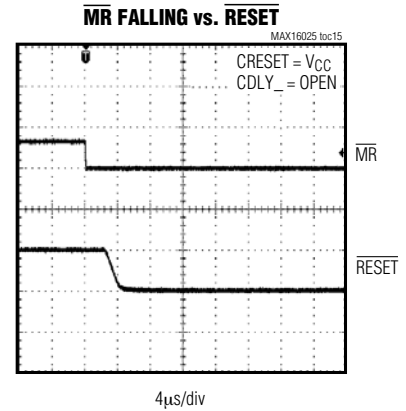
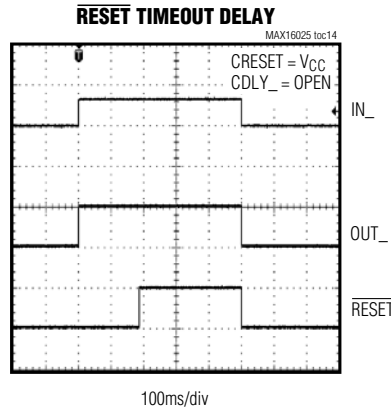
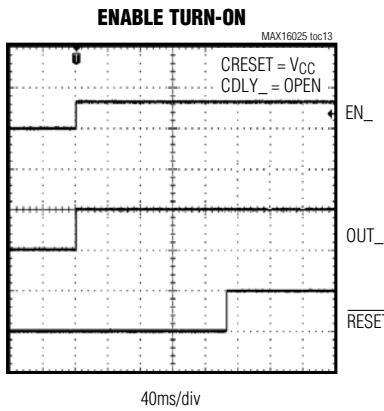
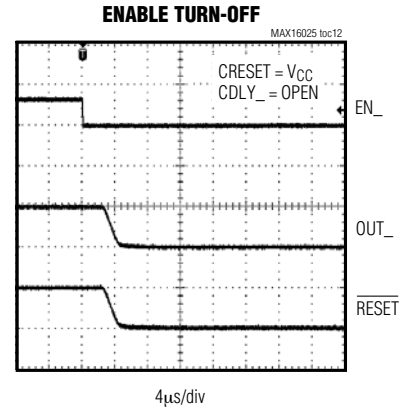
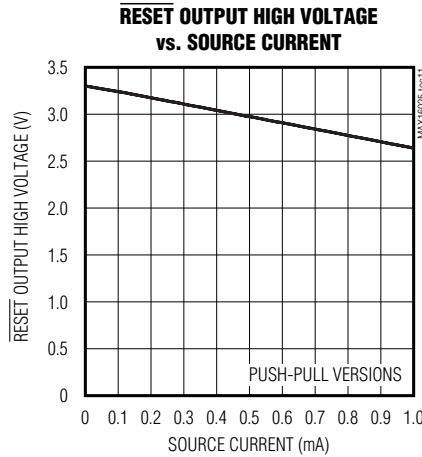
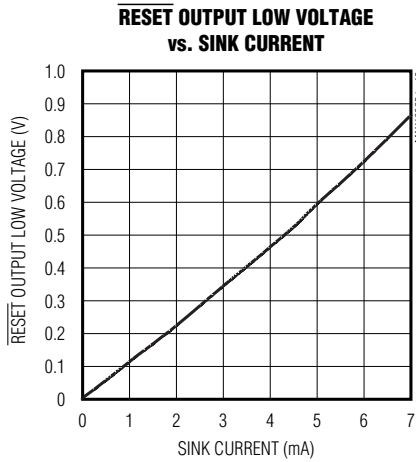

# Dual-/Triple-/Quad-Voltage, Capacitor-Adjustable, Sequencing/Supervisory Circuits

## Pin Description

PIN			NAME	FUNCTION
MAX16025/ MAX16026	MAX16027/ MAX16028	MAX16029/ MAX16030		
1	1	1	VCC	Supply Voltage Input. Connect a 2.2V to 28V supply voltage to power the device. All outputs are low when VCC is below the UVLO. For noisy systems, bypass VCC to GND with a 0.1μF capacitor.
2	2	2	IN1	Monitored Input 1. When the voltage at IN1 exceeds its threshold, OUT1 goes high after the capacitor-adjustable delay period. When the voltage at IN1 falls below its threshold, OUT1 goes low after a propagation delay.
3	3	3	IN2	Monitored Input 2. When the voltage at IN2 exceeds its threshold, OUT2 goes high after the capacitor-adjustable delay period. When the voltage at IN2 falls below its threshold, OUT2 goes low after a propagation delay.
—	4	4	IN3	Monitored Input 3. When the voltage at IN3 exceeds its threshold, OUT3 goes high after the capacitor-adjustable delay period. When the voltage at IN3 falls below its threshold, OUT3 goes low after a propagation delay.
—	—	5	IN4	Monitored Input 4. When the voltage at IN4 exceeds its threshold, OUT4 goes high after the capacitor-adjustable delay period. When the voltage at IN4 falls below its threshold, OUT4 goes low after a propagation delay.
4	5	6	TOL	Threshold Tolerance Input. Connect TOL to GND to select thresholds 5% below nominal. Connect TOL to VCC to select thresholds 10% below nominal.
5	6	7	GND	Ground
6	7	8	EN1	Active-High Logic-Enable Input 1. Driving EN1 low causes OUT1 to go low regardless of the input voltage. Drive EN1 high to enable the monitoring comparator.
7	8	9	EN2	Active-High Logic-Enable Input 2. Driving EN2 low causes OUT2 to go low regardless of the input voltage. Drive EN2 high to enable the monitoring comparator.
—	9	10	EN3	Active-High Logic-Enable Input 3. Driving EN3 low causes OUT3 to go low regardless of the input voltage. Drive EN3 high to enable the monitoring comparator.
—	—	11	EN4	Active-High Logic-Enable Input 4. Driving EN4 low causes OUT4 to go low regardless of the input voltage. Drive EN4 high to enable the monitoring comparator.
8	10	12	TH1	Threshold Select Input 1. Connect TH1 to VCC or GND, or leave it open to select the input-voltage threshold option in conjunction with TH0 (see Table 2).
9	11	13	TH0	Threshold Select Input 0. Connect TH0 to VCC or GND, or leave it open to select the input-voltage threshold option in conjunction with TH1 (see Table 2).
—	—	14	OUT4	Output 4. When the voltage at IN4 is below its threshold or EN4 goes low, OUT4 goes low.
—	12	15	OUT3	Output 3. When the voltage at IN3 is below its threshold or EN3 goes low, OUT3 goes low.
10	13	16	OUT2	Output 2. When the voltage at IN2 is below its threshold or EN2 goes low, OUT2 goes low.

# Dual-/Triple-/Quad-Voltage, Capacitor-Adjustable, Sequencing/Supervisory Circuits

## Pin Description (continued)

MAX16025-MAX16030

PIN			NAME	FUNCTION
MAX16025/ MAX16026	MAX16027/ MAX16028	MAX16029/ MAX16030		
11	14	17	OUT1	Output 1. When the voltage at IN1 is below its threshold or EN1 goes low, OUT1 goes low.
12	15	18	$\overline{\text{RESET}}$	Active-Low Reset Output. $\overline{\text{RESET}}$ asserts low when any of the monitored voltages (IN <sub>n</sub> ) falls below its respective threshold, any EN <sub>n</sub> goes low, or $\overline{\text{MR}}$ is asserted. $\overline{\text{RESET}}$ remains asserted for the reset timeout period after all of the monitored voltages exceed their respective threshold, all EN <sub>n</sub> are high, all OUT <sub>n</sub> are high, and $\overline{\text{MR}}$ is deasserted.
13	16	19	$\overline{\text{MR}}$	Active-Low Manual Reset Input. Pull $\overline{\text{MR}}$ low to assert $\overline{\text{RESET}}$ low. $\overline{\text{RESET}}$ remains low for the reset timeout period after $\overline{\text{MR}}$ is deasserted (as long as all OUT <sub>n</sub> are high).
14	17	20	CRESET	Capacitor-Adjustable Reset Delay Input. Connect an external capacitor from CRESET to GND to set the reset timeout period or connect to V <sub>CC</sub> for the default 140ms minimum reset timeout period. Leave CRESET open for internal propagation delay.
—	—	21	CDLY4	Capacitor-Adjustable Delay Input 4. Connect an external capacitor from CDLY4 to GND to set the IN4 to OUT4 (and EN4 to OUT4) delay period. Leave CDLY4 open for internal propagation delay.
—	18	22	CDLY3	Capacitor-Adjustable Delay Input 3. Connect an external capacitor from CDLY3 to GND to set the IN3 to OUT3 (and EN3 to OUT3) delay period. Leave CDLY3 open for internal propagation delay.
15	19	23	CDLY2	Capacitor-Adjustable Delay Input 2. Connect an external capacitor from CDLY2 to GND to set the IN2 to OUT2 (and EN2 to OUT2) delay period. Leave CDLY2 open for internal propagation delay.
16	20	24	CDLY1	Capacitor-Adjustable Delay Input 1. Connect an external capacitor from CDLY1 to GND to set the IN1 to OUT1 (and EN1 to OUT1) delay period. Leave CDLY1 open for internal propagation delay.
—	—	—	EP	Exposed Pad. EP is internally connected to GND. Connect EP to the ground plane.

**Table 1. Output State\***

EN <sub>n</sub>	IN <sub>n</sub>	OUT <sub>n</sub>
Low	V <sub>IN<sub>n</sub></sub> < V <sub>TH</sub>	Low
High	V <sub>IN<sub>n</sub></sub> < V <sub>TH</sub>	Low
Low	V <sub>IN<sub>n</sub></sub> > V <sub>TH</sub>	Low
High	V <sub>IN<sub>n</sub></sub> > V <sub>TH</sub>	OUT <sub>n</sub> = high (MAX16026/MAX16028/ MAX16030)
		OUT <sub>n</sub> = high impedance (MAX16025/MAX16027/ MAX16029)

\*When V<sub>CC</sub> falls below the UVLO, all outputs go low regardless of the state of EN<sub>n</sub> and V<sub>IN<sub>n</sub></sub>. The outputs are guaranteed to be in the correct state for V<sub>CC</sub> down to 1.2V.

**Table 2. Input-Voltage Threshold Selector**

TH1/TH0 LOGIC	IN1 (ALL VERSIONS) (V)	IN2 (ALL VERSIONS) (V)	IN3 (MAX16027/MAX16028) (V)	IN4 (MAX16029/MAX16030) (V)
Low/Low	3.3	2.5	1.8	1.5
Low/High	3.3	1.8	Adj	Adj
Low/Open	3.3	1.5	Adj	Adj
High/Low	3.3	1.2	1.8	2.5
High/High	2.5	1.8	Adj	Adj
High/Open	3.3	Adj	2.5	Adj
Open/Low	3.3	Adj	Adj	Adj
Open/High	2.5	Adj	Adj	Adj
Open/Open	Adj	Adj	Adj	Adj

# Dual-/Triple-/Quad-Voltage, Capacitor-Adjustable, Sequencing/Supervisory Circuits

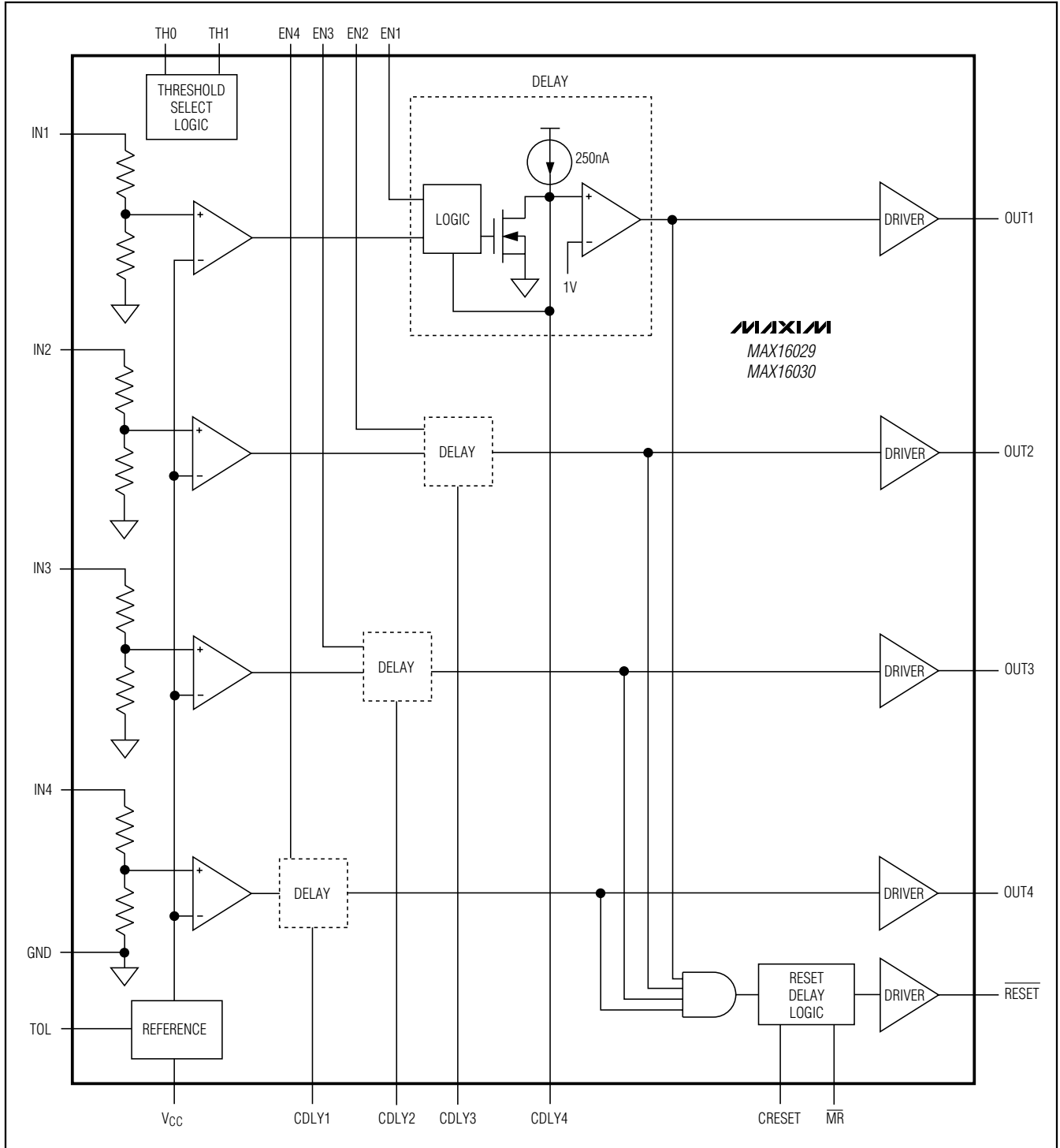

Figure 1. MAX16029/MAX16030 Simplified Functional Diagram

# Dual-/Triple-/Quad-Voltage, Capacitor-Adjustable, Sequencing/Supervisory Circuits

MAX16025-MAX16030

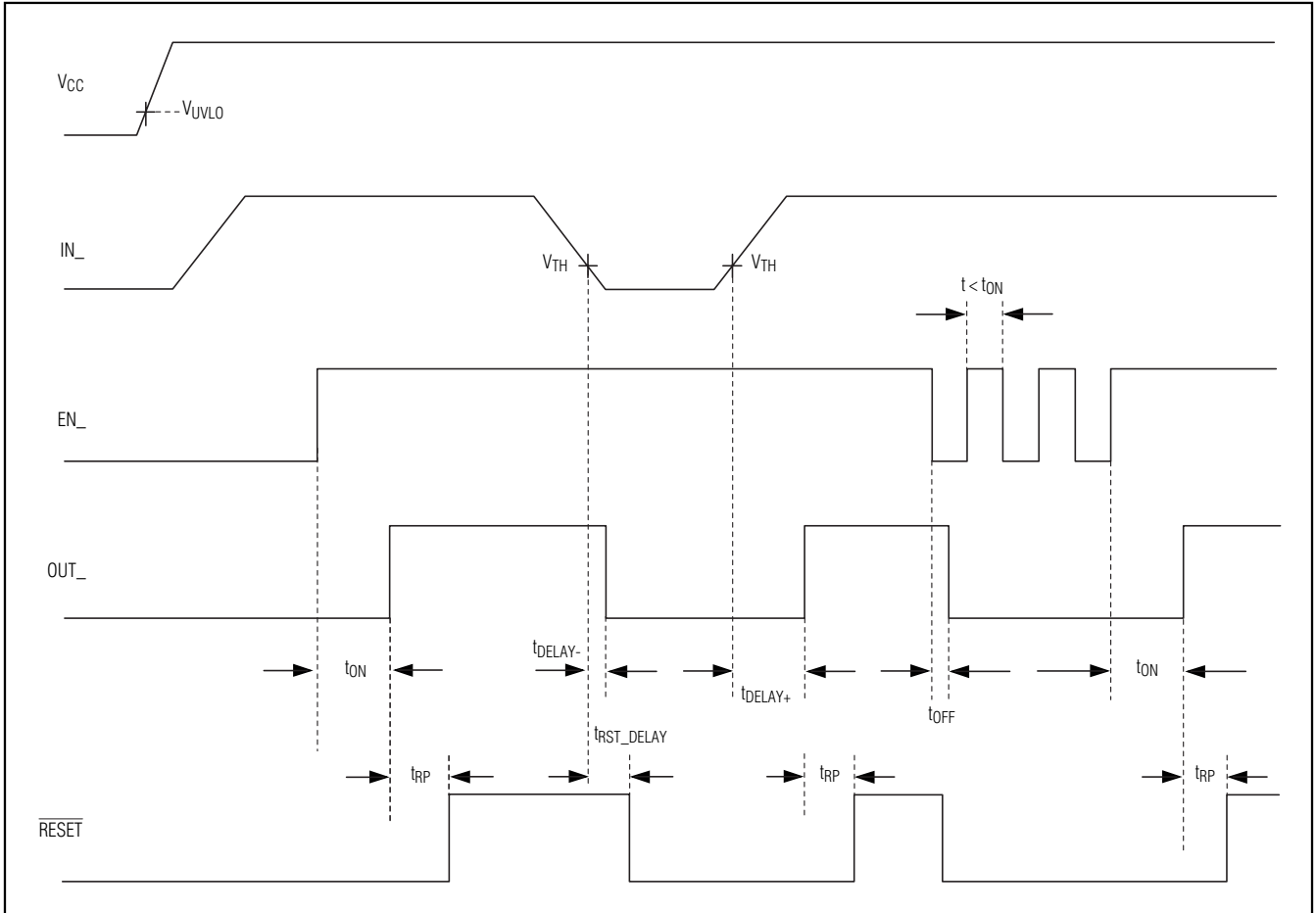

Figure 2. Timing Diagram (CDLY\_Open)

## Detailed Description

The MAX16025-MAX16030 are low-voltage, accurate, dual/triple-/quad-voltage microprocessor ( $\mu$ P) supervisors in a small TQFN package. These devices provide supervisory and sequencing functions for complex multivoltage systems. The MAX16025/MAX16026 monitor two voltages, the MAX16027/MAX16028 monitor three voltages, and the MAX16029/MAX16030 monitor four voltages.

The MAX16025-MAX16030 offer independent outputs and enable functions for each monitored voltage. This configuration allows the device to operate as four separate supervisory circuits or be daisy-chained together to allow controlled sequencing of power supplies during

power-up initialization. When all of the monitored voltages exceed their respective thresholds, an independent reset output deasserts to allow the system processor to operate.

These devices offer enormous flexibility as there are nine threshold options that are selected through two threshold-select logic inputs. Each monitor circuit also offers an independent enable input to allow both digital and analog control of each monitor output. A tolerance select input allows these devices to be used in systems requiring 5% or 10% power-supply tolerances. In addition, the time delays and reset timeout can be adjusted using small capacitors. There is also a fixed 140ms minimum reset timeout feature.

# Dual-/Triple-/Quad-Voltage, Capacitor-Adjustable, Sequencing/Supervisory Circuits

## Applications Information

### Tolerance

The MAX16025–MAX16030 feature a pin-selectable threshold tolerance. Connect TOL to GND to select the thresholds 5% below the nominal value. Connect TOL to V<sub>CC</sub> to select the threshold tolerance 10% below the nominal voltage. Do not leave TOL unconnected.

### Adjustable Input

These devices offer several monitoring options with both fixed and/or adjustable reset thresholds (see Table 2). For the adjustable threshold inputs, the threshold voltage (V<sub>TH</sub>) at each adjustable IN<sub>-</sub> input is typically 0.5V (TOL = GND) or 0.472V (TOL = V<sub>CC</sub>). To monitor a voltage V<sub>INTH</sub>, connect a resistive divider network to the circuit as shown in Figure 3 and use the following equation to calculate the threshold voltage:

$$V_{INTH} = V_{TH} \times \left(1 + \frac{R1}{R2}\right)$$

Choosing the proper external resistors is a balance between accuracy and power use. The input to the voltage monitor is a high-impedance input with a small 100nA leakage current. This leakage current contributes to the overall error of the threshold voltage where the output is asserted. This induced error is proportional to the value of the resistors used to set the threshold. With lower value resistors, this error is reduced, but the amount of power consumed in the resistors increases.

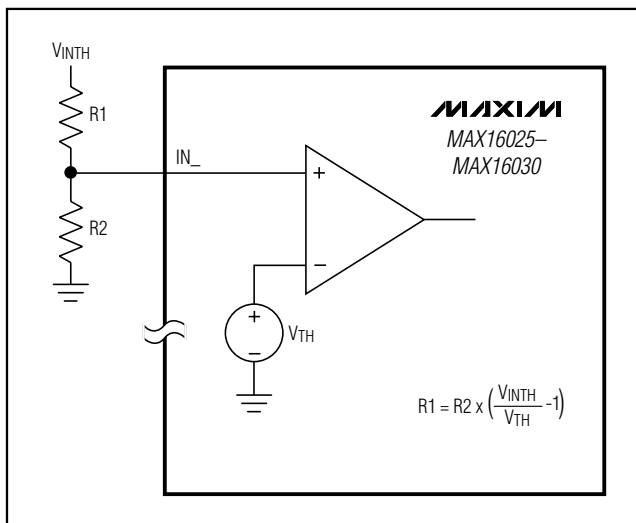

Figure 3. Setting the Adjustable Input

The following equation is provided to help estimate the value of the resistors based on the amount of acceptable error:

$$R1 = \frac{e_A \times V_{INTH}}{I_L}$$

where e<sub>A</sub> is the fraction of the maximum acceptable absolute resistive divider error attributable to the input leakage current (use 0.01 for ±1%), V<sub>INTH</sub> is the voltage at which the output (OUT<sub>-</sub>) should assert, and I<sub>L</sub> is the worst-case IN<sub>-</sub> leakage current (see the *Electrical Characteristics*). Calculate R2 as follows:

$$R2 = \frac{V_{TH} \times R1}{V_{INTH} - V_{TH}}$$

### Unused Inputs

Connect any unused IN<sub>-</sub> and EN<sub>-</sub> inputs to V<sub>CC</sub>.

### OUT<sub>-</sub> Output

An OUT<sub>-</sub> goes low when its respective IN<sub>-</sub> input voltage drops below its specified threshold or when its EN<sub>-</sub> goes low (see Table 1). OUT<sub>-</sub> goes high when EN<sub>-</sub> is high and V<sub>IN<sub>-</sub></sub> is above its threshold after a time delay. The MAX16025/MAX16027/MAX16029 feature open-drain, outputs while the MAX16026/MAX16028/MAX16030 have push-pull outputs. Open-drain outputs require an external pullup resistor to any voltage from 0 to 28V.

### RESET Output

RESET asserts low when any of the monitored voltages (IN<sub>-</sub>) falls below its respective threshold, any EN<sub>-</sub> goes low, or MR is asserted. RESET remains asserted for the reset timeout period after all of the monitored voltages exceed their respective threshold, all EN<sub>-</sub> are high, all OUT<sub>-</sub> are high, and MR is deasserted. The MAX16025/MAX16027/MAX16029 have an open-drain, active-low reset output, while the MAX16026/MAX16028/MAX16030 have a push-pull, active-low reset output. Open-drain RESET requires an external pullup resistor to any voltage from 0 to 28V.

### Adjustable Reset Timeout Period (CRESET)

All of these parts offer an internally fixed reset timeout (140ms min) by connecting CRESET to V<sub>CC</sub>. The reset timeout can also be adjusted by connecting a capacitor from CRESET to GND. When the voltage at CRESET reaches 0.5V, RESET goes high. When RESET goes high, CRESET is immediately held low.

## Dual-/Triple-/Quad-Voltage, Capacitor-Adjustable, Sequencing/Supervisory Circuits

Calculate the reset timeout period as follows:

$$t_{RP} = \frac{V_{TH-RESET}}{I_{CH-RESET}} \times C_{CRESET} + 35 \times 10^{-6}$$

where  $V_{TH-RESET}$  is 0.5V,  $I_{CH-RESET}$  is 0.5 $\mu$ A,  $t_{RP}$  is in seconds, and  $C_{CRESET}$  is in Farads. To ensure timing accuracy and proper operation, minimize leakage at  $C_{CRESET}$ .

### Adjustable Delay (CDLY\_)

When  $V_{IN}$  rises above  $V_{TH}$  with  $EN_+$  high, the internal 250nA current source begins charging an external capacitor connected from  $CDLY_+$  to GND. When the voltage at  $CDLY_+$  reaches 1V,  $OUT_+$  goes high. When  $OUT_+$  goes high,  $CDLY_+$  is immediately held low. Adjust the delay ( $t_{DELAY}$ ) from when  $V_{IN}$  rises above  $V_{TH}$  (with  $EN_+$  high) to  $OUT_+$  going high according to the equation:

$$t_{DELAY} = \frac{V_{TH-CDLY}}{I_{CH-CDLY}} \times C_{CDLY} + 35 \times 10^{-6}$$

where  $V_{TH-CDLY}$  is 1V,  $I_{CH-CDLY}$  is 0.25 $\mu$ A,  $C_{CDLY}$  is in Farads,  $t_{DELAY}$  is in seconds, and  $t_{DELAY+}$  is the internal propagation delay of the device. To ensure timing accuracy and proper operation, minimize leakage at  $CDLY_+$ .

### Manual-Reset Input ( $\overline{MR}$ )

Many  $\mu$ P-based products require manual-reset capability, allowing the operator, a test technician, or external logic circuitry to initiate a reset. A logic-low on  $\overline{MR}$  asserts  $\overline{RESET}$  low.  $\overline{RESET}$  remains asserted while  $\overline{MR}$  is low and during the reset timeout period (140ms fixed or capacitor adjustable) after  $\overline{MR}$  returns high. The  $\overline{MR}$  input has a 500nA internal pullup, so it can be left unconnected, if not used.  $\overline{MR}$  can be driven with TTL or CMOS logic levels, or with open-drain/collector outputs. Connect a normally open momentary switch from  $\overline{MR}$  to GND to create a manual-reset function. External

debounce circuitry is not required. If  $\overline{MR}$  is driven from long cables or if the device is used in a noisy environment, connect a 0.1 $\mu$ F capacitor from  $\overline{MR}$  to GND to provide additional noise immunity.

### Pullup Resistor Values

The exact value of the pullup resistors for the open-drain outputs is not critical, but some consideration should be made to ensure the proper logic levels when the device is sinking current. For example, if  $V_{CC} = 2.25V$  and the pullup voltage is 28V, keep the sink current less than 0.5mA as shown in the *Electrical Characteristics* table. As a result, the pullup resistor should be greater than 56k $\Omega$ . For a 12V pullup, the resistor should be larger than 24k $\Omega$ . Note that the ability to sink current is dependent on the  $V_{CC}$  supply voltage.

### Power-Supply Bypassing

The device operates with a  $V_{CC}$  supply voltage from 2.2V to 28V. When  $V_{CC}$  falls below the UVLO threshold, all the outputs go low and stay low until  $V_{CC}$  falls below 1.2V. For noisy systems or fast rising transients on  $V_{CC}$ , connect a 0.1 $\mu$ F ceramic capacitor from  $V_{CC}$  to GND as close to the device as possible to provide better noise and transient immunity.

### Ensuring Valid Output with $V_{CC}$ Down to 0V (MAX16026/MAX16028/MAX16030 Only)

When  $V_{CC}$  falls below 1.2V, the ability for the output to sink current decreases. In order to ensure a valid output as  $V_{CC}$  falls to 0V, connect a 100k $\Omega$  resistor from  $OUT/\overline{RESET}$  to GND.

### Typical Application Circuits

Figures 4 and 5 show typical applications for the MAX16025–MAX16030. In high-power applications, using an n-channel device reduces the loss across the MOSFETs as it offers a lower drain-to-source on-resistance. However, an n-channel MOSFET requires a sufficient  $V_{GS}$  voltage to fully enhance it for a low  $R_{DS(on)}$ . The application in Figure 4 shows the MAX16027 configured in a multiple-output sequencing application. Figure 5 shows the MAX16029 in a power-supply sequencing application using n-channel MOSFETs.

# Dual-/Triple-/Quad-Voltage, Capacitor-Adjustable, Sequencing/Supervisory Circuits

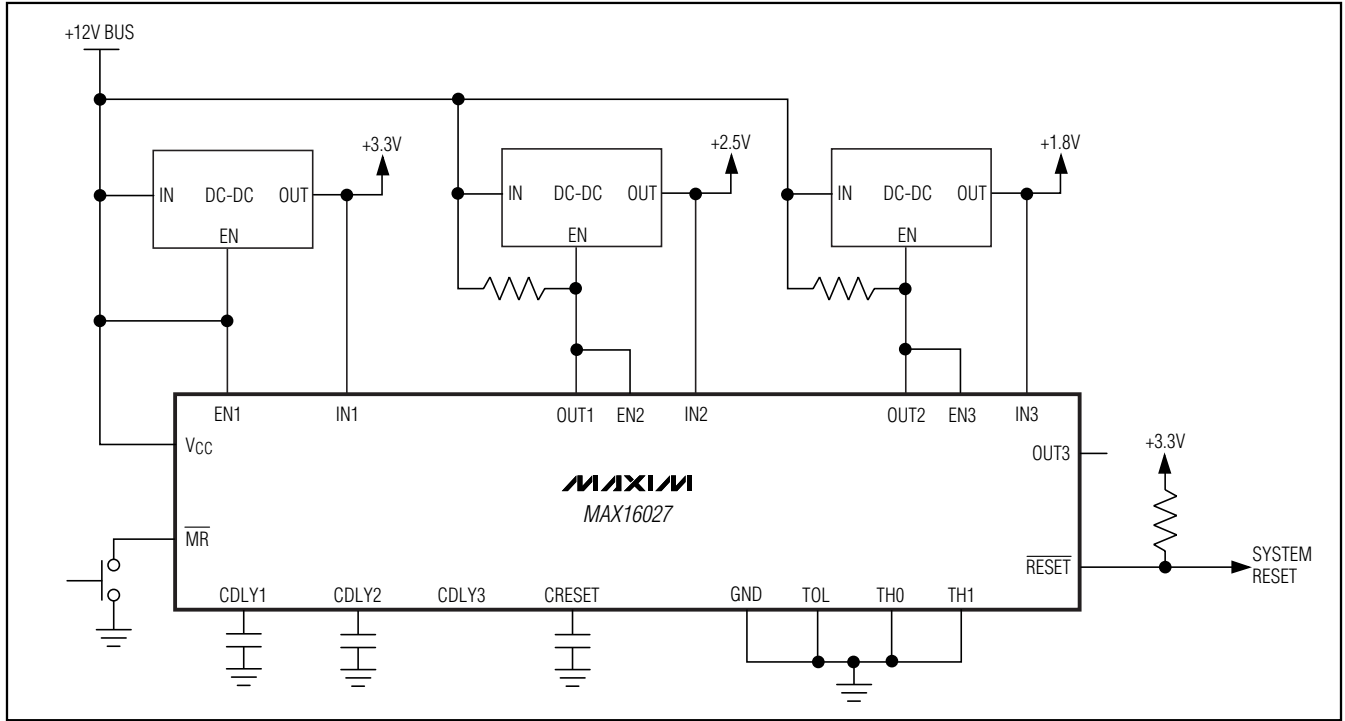

Figure 4. Sequencing Multiple-Voltage System

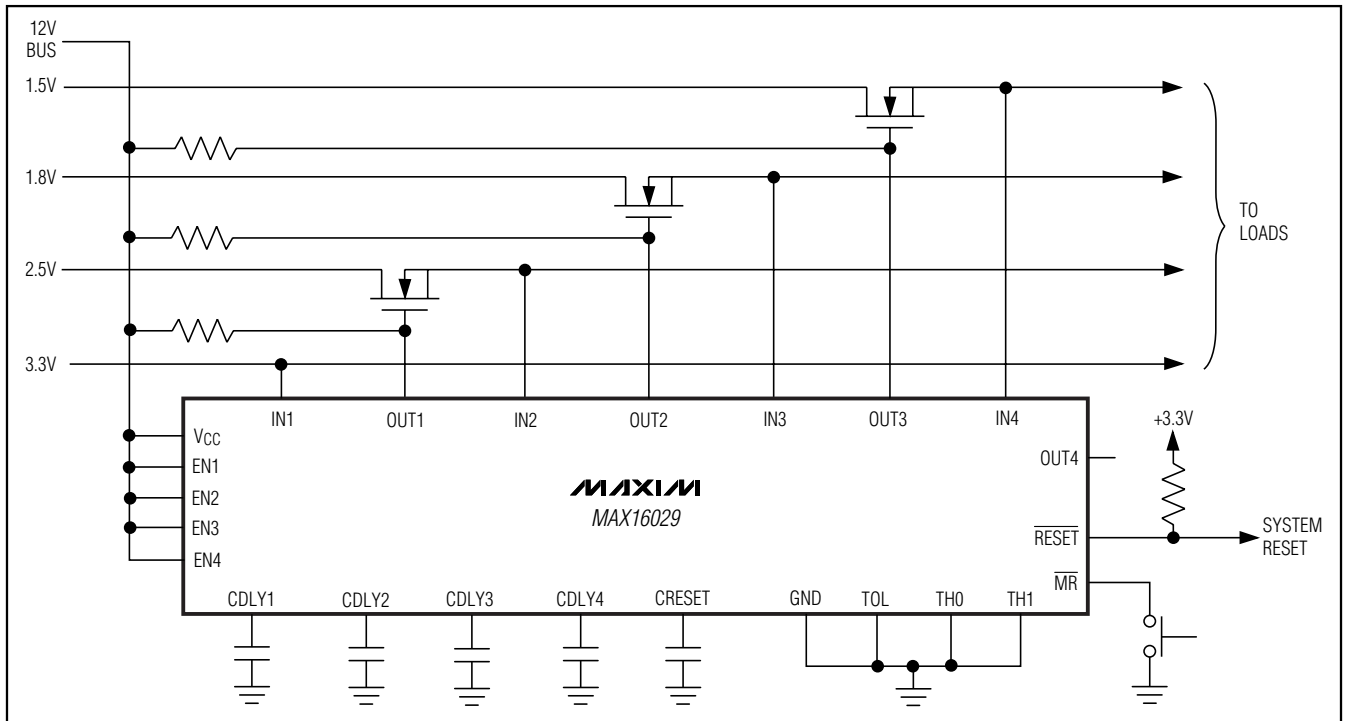
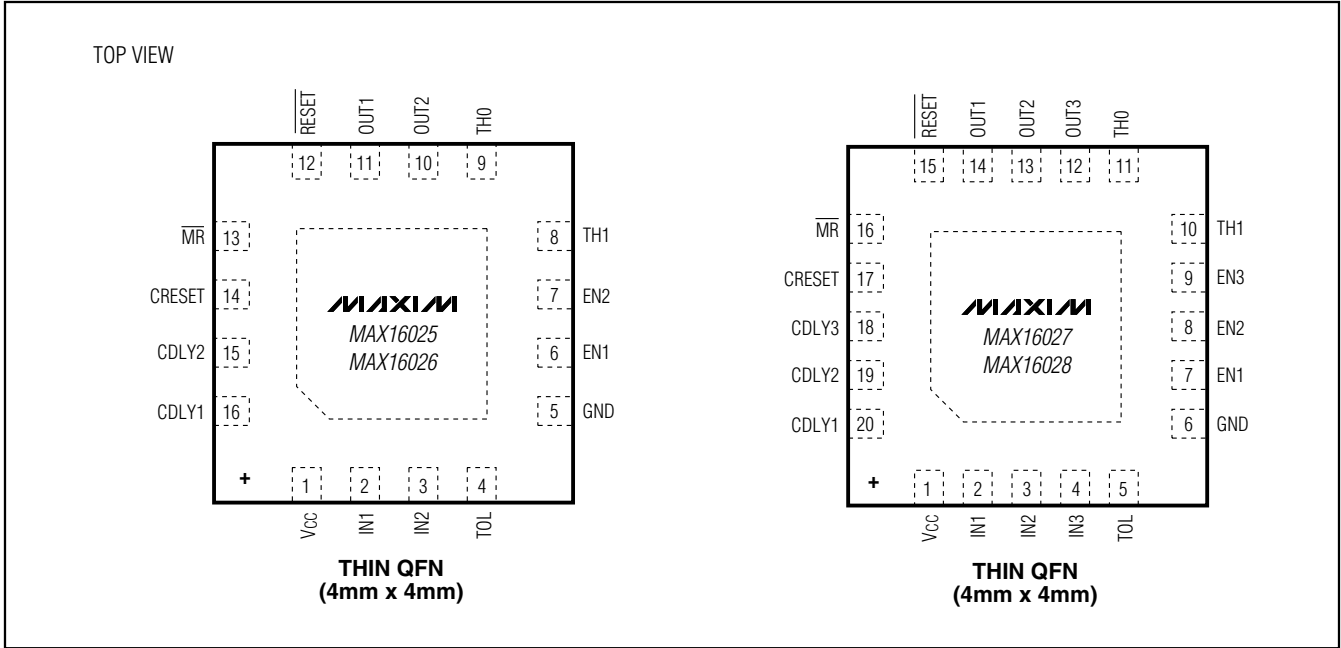

Figure 5. Multiple-Voltage Sequencing Using n-Channel FETs

# Dual-/Triple-/Quad-Voltage, Capacitor-Adjustable, Sequencing/Supervisory Circuits

## Pin Configurations (continued)

**MAX16025-MAX16030**



## Chip Information

PROCESS: BICMOS

TRANSISTOR COUNT: 3642

# Dual-/Triple-/Quad-Voltage, Capacitor-Adjustable, Sequencing/Supervisory Circuits

## Package Information

(The package drawing(s) in this data sheet may not reflect the most current specifications. For the latest package outline information go to [www.maxim-ic.com/packages](http://www.maxim-ic.com/packages).)

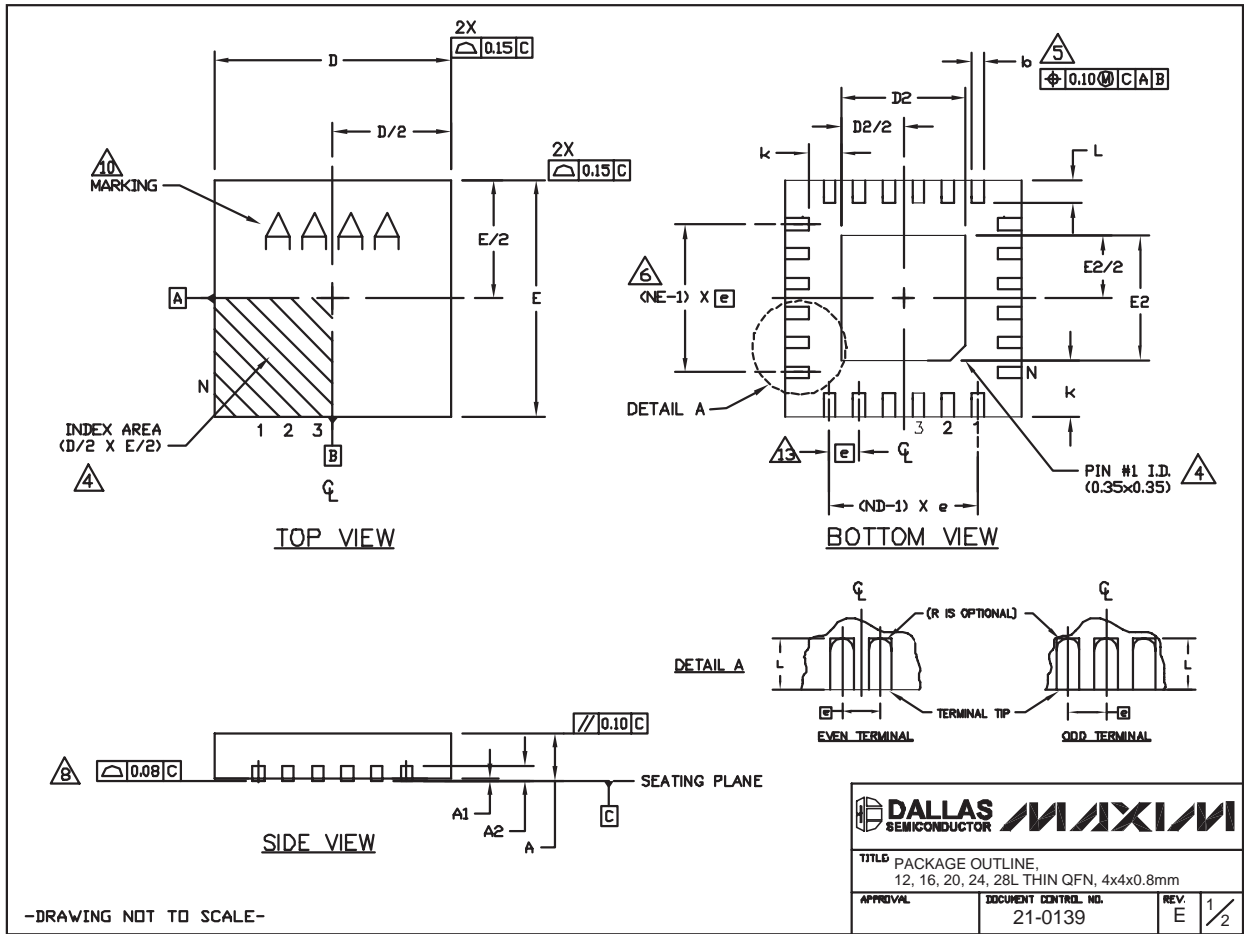

24L QFN THIN.EPS

# Dual-/Triple-/Quad-Voltage, Capacitor-Adjustable, Sequencing/Supervisory Circuits

## Package Information (continued)

(The package drawing(s) in this data sheet may not reflect the most current specifications. For the latest package outline information go to [www.maxim-ic.com/packages](http://www.maxim-ic.com/packages).)

MAX16025-MAX16030

COMMON DIMENSIONS															EXPOSED PAD VARIATIONS									
PKG REF.	12L 4x4			16L 4x4			20L 4x4			24L 4x4			28L 4x4			PKG. CODES	D2			E2			DOWN BONDS ALLOWED	
	MIN.	NOM.	MAX.	MIN.	NOM.	MAX.	MIN.	NOM.	MAX.	MIN.	NOM.	MAX.	MIN.	NOM.	MAX.		MIN.	NOM.	MAX.	MIN.	NOM.	MAX.		
A	0.70	0.75	0.80	0.70	0.75	0.80	0.70	0.75	0.80	0.70	0.75	0.80	0.70	0.75	0.80	T1244-3	1.95	2.10	2.25	1.95	2.10	2.25	YES	
A1	0.0	0.02	0.05	0.0	0.02	0.05	0.0	0.02	0.05	0.0	0.02	0.05	0.0	0.02	0.05	T1244-4	1.95	2.10	2.25	1.95	2.10	2.25	NO	
A2	0.20 REF			0.20 REF			0.20 REF			0.20 REF			0.20 REF			T1644-3	1.95	2.10	2.25	1.95	2.10	2.25	YES	
b	0.25	0.30	0.35	0.25	0.30	0.35	0.20	0.25	0.30	0.18	0.23	0.30	0.15	0.20	0.25	T1644-4	1.95	2.10	2.25	1.95	2.10	2.25	NO	
D	3.90	4.00	4.10	3.90	4.00	4.10	3.90	4.00	4.10	3.90	4.00	4.10	3.90	4.00	4.10	T2044-2	1.95	2.10	2.25	1.95	2.10	2.25	YES	
E	3.90	4.00	4.10	3.90	4.00	4.10	3.90	4.00	4.10	3.90	4.00	4.10	3.90	4.00	4.10	T2044-3	1.95	2.10	2.25	1.95	2.10	2.25	NO	
e	0.80 BSC.			0.65 BSC.			0.50 BSC.			0.50 BSC.			0.40 BSC.			T2444-2	1.95	2.10	2.25	1.95	2.10	2.25	YES	
k	0.25	-	-	0.25	-	-	0.25	-	-	0.25	-	-	0.25	-	-	T2444-3	2.45	2.60	2.63	2.45	2.60	2.63	YES	
L	0.45	0.55	0.65	0.45	0.55	0.65	0.45	0.55	0.65	0.30	0.40	0.50	0.30	0.40	0.50	T2444-4	2.45	2.60	2.63	2.45	2.60	2.63	NO	
N	12			16			20			24			28			T2844-1	2.50	2.60	2.70	2.50	2.60	2.70	NO	
ND	3			4			5			6			7											
NE	3			4			5			6			7											
JEDEC Ref.	VGG3			VGGC			WGGD-1			WGGD-2			VGGE											

NOTES:

- DIMENSIONING & TOLERANCING CONFORM TO ASME Y14.5M-1994.
- ALL DIMENSIONS ARE IN MILLIMETERS. ANGLES ARE IN DEGREES.
- N IS THE TOTAL NUMBER OF TERMINALS.
- THE TERMINAL #1 IDENTIFIER AND TERMINAL NUMBERING CONVENTION SHALL CONFORM TO JEDEC 95-1 SPP-012. DETAILS OF TERMINAL #1 IDENTIFIER ARE OPTIONAL, BUT MUST BE LOCATED WITHIN THE ZONE INDICATED. THE TERMINAL #1 IDENTIFIER MAY BE EITHER A MOLD OR MARKED FEATURE.
- DIMENSION b APPLIES TO METALLIZED TERMINAL AND IS MEASURED BETWEEN 0.25 mm AND 0.30 mm FROM TERMINAL TIP.
- ND AND NE REFER TO THE NUMBER OF TERMINALS ON EACH D AND E SIDE RESPECTIVELY.
- DEPOPULATION IS POSSIBLE IN A SYMMETRICAL FASHION.
- COPLANARITY APPLIES TO THE EXPOSED HEAT SINK SLUG AS WELL AS THE TERMINALS.
- DRAWING CONFORMS TO JEDEC MO220, EXCEPT FOR T2444-3, T2444-4 AND T2844-1.
- MARKING IS FOR PACKAGE ORIENTATION REFERENCE ONLY.
- COPLANARITY SHALL NOT EXCEED 0.08mm
- WARPAGE SHALL NOT EXCEED 0.10mm
- LEAD CENTERLINES TO BE AT TRUE POSITION AS DEFINED BY BASIC DIMENSION "e", ±0.05.
- NUMBER OF LEADS SHOWN ARE FOR REFERENCE ONLY

-DRAWING NOT TO SCALE-

TITLE PACKAGE OUTLINE, 12, 16, 20, 24, 28L THIN QFN, 4x4x0.8mm	
APPROVAL	DOCUMENT CONTROL NO. 21-0139
REV. E	2/2

## Revision History

Pages changed at Rev 1: 1, 3, 15

Maxim cannot assume responsibility for use of any circuitry other than circuitry entirely embodied in a Maxim product. No circuit patent licenses are implied. Maxim reserves the right to change the circuitry and specifications without notice at any time.

Maxim Integrated Products, 120 San Gabriel Drive, Sunnyvale, CA 94086 408-737-7600 15

## Looking for pricing, stock, or lifecycle information?

Click below to explore more details on WIN SOURCE:

 [View MAX16025TE+ on WIN SOURCE](#)

 [Maxim Integrated](#) Information

## Optimize Your Supply Chain with WIN SOURCE Solutions

-  Global Sourcing Solution
-  Obsolete Management
-  Cost Control Management
-  Shortage Management
-  Alternative Solution
-  Excess Inventory Management