



**THE DATASHEET OF
MAX14933ASE+**



MAX14933

Two-Channel, 2.75kV_{RMS} I²C Isolator

General Description

The MAX14933 is a two-channel, 2.75kV_{RMS} I²C digital isolator utilizing Maxim's proprietary process technology. For applications requiring 5kV_{RMS} of isolation, refer to the MAX14937 data sheet. The MAX14933 transfers digital signals between circuits with different power domains at ambient temperatures up to +125°C.

The device offers two bidirectional, open-drain channels for applications, such as I²C, that require data to be transmitted in both directions on the same line.

The device features independent 2.25V to 5.5V supplies on each side of the isolator. The device operates from DC to 1.7MHz and can be used in isolated I²C busses with clock stretching.

The MAX14933 is available in both a 16-pin wide-body (10.3mm x 7.5mm) and narrow-body (9.9mm x 3.9mm) SOIC package. All devices are rated for operation at ambient temperatures of -40°C to +125°C.

Applications

- I²C, SMBus, PMBus™ Interfaces
- Power Supplies
- Battery Management
- Instrumentation

Functional Diagram

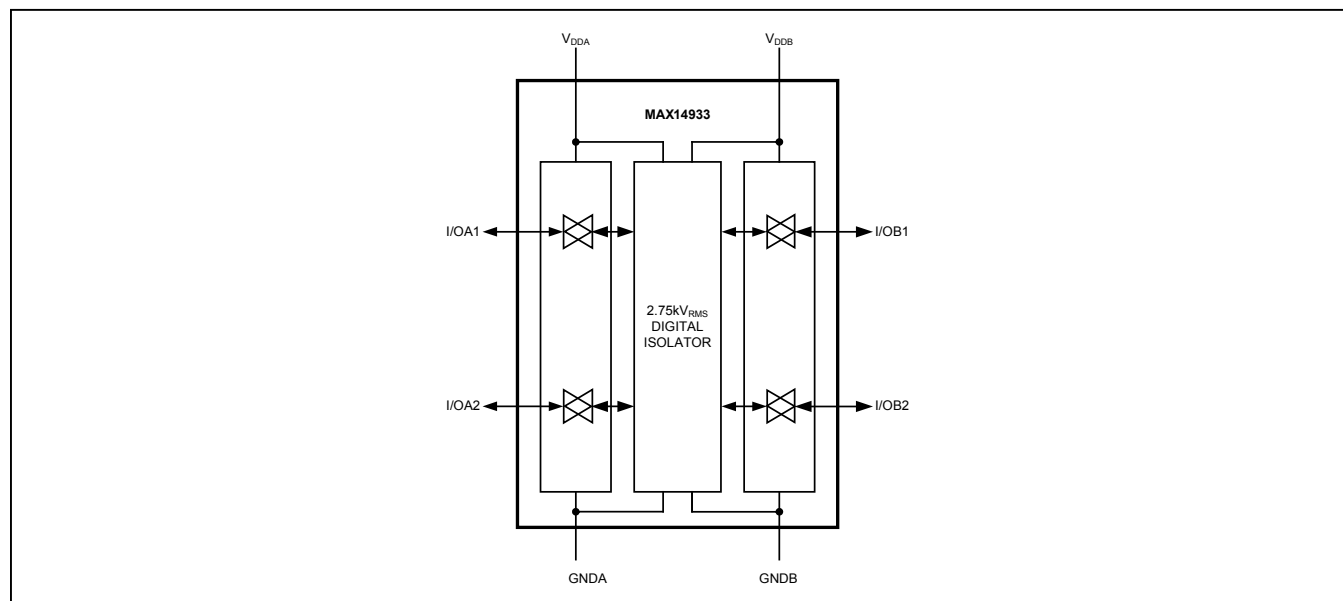

PMBus is a trademark of SMIF, Inc.

Benefits and Features

- Robust Galvanic Isolation of Digital Signals
 - Withstands 2.75kV_{RMS} for 60s (V_{ISO})
 - Continuously Withstands 443V_{RMS} (V_{IOWM})
 - 630V_{PEAK} Repetitive Peak Voltage (V_{IORM})
 - Withstands ±10kV Surge per IEC 61000-4-5
 - 2 Packages (4mm or 8mm Creepage and Clearance)
- Interfaces Directly with Most Micros and FPGAs
 - Accepts 2.25V to 5.5V Supplies
 - Bidirectional Data Transfer from DC to 1.7MHz
- Low Power Consumption
 - 5.3mA per Channel Typical at 1.7MHz

Safety Regulatory Approvals

- UL According to UL1577
- cUL According to CSA Bulletin 5A
- VDE 0884-10

Ordering Information appears at end of data sheet.

Absolute Maximum Ratings

V_{DDA} to G_{NDA}.....-0.3V to +6V
 V_{DDB} to G_{NDB}.....-0.3V to +6V
 I/OA_{_} to G_{NDA}.....-0.3V to +6V
 I/OB_{_} to G_{NDB}.....-0.3V to +6V
 Short-Circuit Duration
 (I/OA_{_} to G_{NDA}, I/OB_{_} to G_{NDB})Continuous

Continuous Power Dissipation (T_A = +70°C)
 Wide SO (derate 14.1mW/°C above +70°C)..... 1126.8mW
 Narrow SO (derate 13.3mW/°C above +70°C)..... 1066.7mW
 Operating Temperature Range..... -40°C to +125°C
 Maximum Junction Temperature +150°C
 Storage Temperature Range..... -65°C to +150°C
 Lead Temperature (soldering, 10s) +300°C
 Soldering Temperature (reflow) +260°C

Stresses beyond those listed under "Absolute Maximum Ratings" may cause permanent damage to the device. These are stress ratings only, and functional operation of the device at these or any other conditions beyond those indicated in the operational sections of the specifications is not implied. Exposure to absolute maximum rating conditions for extended periods may affect device reliability.

Package Thermal Characteristics (Note 1)

Wide SOIC

Junction-to-Ambient Thermal Resistance (θ_{JA}).....71°C/W
 Junction-to-Case Thermal Resistance (θ_{JC}).....23°C/W

Narrow SOIC

Junction-to-Ambient Thermal Resistance (θ_{JA}).....75°C/W
 Junction-to-Case Thermal Resistance (θ_{JC}).....24°C/W

Note 1: Package thermal resistances were obtained using the method described in JEDEC specification JESD51-7, using a four-layer board. For detailed information on package thermal considerations, refer to www.maximintegrated.com/thermal-tutorial.

DC Electrical Characteristics

V_{DDA} - V_{G_{NDA}} = +2.25V to +5.5V, V_{DDB} - V_{G_{NDB}} = +2.25V to +5.5V, T_A = -40°C to +125°C, unless otherwise noted. Typical values are at V_{DDA} - V_{G_{NDA}} = +3.3V, V_{DDB} - V_{G_{NDB}} = +3.3V, V_{G_{NDA}} = V_{G_{NDB}}, T_A = +25°C, unless otherwise noted. (Note 2) (Note 3)

PARAMETER	SYMBOL	CONDITIONS	MIN	TYP	MAX	UNITS
POWER SUPPLY						
Operating Supply Voltage	V _{DDA}	Relative to G _{NDA}	2.25		5.5	V
	V _{DDB}	Relative to G _{NDB}	2.25		5.5	V
Undervoltage-Lockout Threshold	V _{UVLO_}	V _{DD} rising	1.7	2.0	2.2	V
Undervoltage-Lockout Threshold Hysteresis	V _{UVLO_} HYST			85		mV
Supply Current	I _{DDA}	Side A, all channels DC or 1.7MHz	V _{DDA} = 5V	6	9	mA
			V _{DDA} = 3.3V	6	9	
			V _{DDA} = 2.5V	5.9	9	
	I _{DDB}	Side B, all channels DC or 1.7MHz	V _{DDB} = 5V	4.8	8	
			V _{DDB} = 3.3V	4.8	8	
			V _{DDB} = 2.5V	4.7	8	
Static Output Loading	I _{I/OA_}	Side A	0.5		3	mA
	I _{I/OB_}	Side B	0.5		30	

DC Electrical Characteristics (continued)

$V_{DDA} - V_{GNDA} = +2.25V$ to $+5.5V$, $V_{DDB} - V_{GNDB} = +2.25V$ to $+5.5V$, $T_A = -40^{\circ}C$ to $+125^{\circ}C$, unless otherwise noted. Typical values are at $V_{DDA} - V_{GNDA} = +3.3V$, $V_{DDB} - V_{GNDB} = +3.3V$, $V_{GNDA} = V_{GNDB}$, $T_A = +25^{\circ}C$, unless otherwise noted. (Note 2) (Note 3)

PARAMETER	SYMBOL	CONDITIONS	MIN	TYP	MAX	UNITS
LOGIC INPUTS AND OUTPUTS						
Input High Voltage	V_{IH}	$V_{I/OA_}$ relative to GNDA	0.7			V
		$V_{I/OB_}$ relative to GNDB	$0.7 \times V_{DDB}$			
Input Low Voltage	V_{IL}	$V_{I/OA_}$ relative to GNDA			0.5	V
		$V_{I/OB_}$ relative to GNDB			$0.3 \times V_{DDB}$	
Input/Output Logic-Low Level Difference	$DV_{I/OL}$	$I_{/OA_}$ (Note 4), $V_{OL} - V_{IL}$	50			mV
Output Voltage Low	V_{OL}	$V_{I/OA_}$ relative to GNDA, $I_{I/OA_} = 3mA$ sink	600		900	mV
		$V_{I/OA_}$ relative to GNDA, $I_{I/OA_} = 0.5mA$ sink	600		850	
		$V_{I/OB_}$ relative to GNDB, $I_{I/OB_} = 30mA$ sink			400	
Leakage Current	I_L	$I_{/OA_} = V_{DDA}$, $I_{/OB_} = V_{DDB}$	-1		+1	μA
Input Capacitance	C_{IN}	$I_{/OA_}$, $I_{/OB_}$, $f = 1MHz$		5		pF

Dynamic Characteristics

V_{DDA} - V_{GNDA} = +2.25V to +5.5V, V_{DDB} - V_{GNDB} = +2.25V to +5.5V, T_A = -40°C to +125°C, unless otherwise noted. Typical values are at V_{DDA} - V_{GNDA} = +3.3V, V_{DDB} - V_{GNDB} = +3.3V, V_{GNDA} = V_{GNDB}, T_A = +25°C, unless otherwise noted. (Note 5)

PARAMETER	SYMBOL	CONDITIONS		MIN	TYP	MAX	UNITS
Common-Mode Transient Immunity	CMTI	I _N = GND_ or V _{DD} _ (Note 6)			25		kV/μs
Maximum Frequency	f _{MAX}					1.7	MHz
Fall Time (Figure 1)	t _{FA}	I/OA_ = 0.9V _{DDA} to 0.9V	4.5V ≤ V _{DDA} , V _{DDB} ≤ 5.5V, C _{LA} = 40pF, R _A = 1.6kΩ, C _{LB} = 400pF, R _B = 180Ω			80	ns
			3.0V ≤ V _{DDA} , V _{DDB} ≤ 3.6V, C _{LA} = 40pF, R _A = 1kΩ, C _{LB} = 400pF, R _B = 120Ω			65	
			2.25V ≤ V _{DDA} , V _{DDB} ≤ 2.75V, C _{LA} = 40pF, R _A = 810Ω, C _{LB} = 400pF, R _B = 91Ω			55	
	t _{FB}	I/OB_ = 0.9V _{DDB} to 0.1V _{DDB}	4.5V ≤ V _{DDA} , V _{DDB} ≤ 5.5V, C _{LA} = 40pF, R _A = 1.6kΩ, C _{LB} = 400pF, R _B = 180Ω			35	
			3.0V ≤ V _{DDA} , V _{DDB} ≤ 3.6V, C _{LA} = 40pF, R _A = 1kΩ, C _{LB} = 400pF, R _B = 120Ω			45	
			2.25V ≤ V _{DDA} , V _{DDB} ≤ 2.75V, C _{LA} = 40pF, R _A = 810kΩ, C _{LB} = 400pF, R _B = 91Ω			75	
Propagation Delay (Figure 1)	t _{PLHAB}	I/OA_ = 0.5V _{DDA} to I/OB_ = 0.7V _{DDB}	4.5V ≤ V _{DDA} , V _{DDB} ≤ 5.5V, C _{LA} = 0pF, R _A = 1.6kΩ, C _{LB} = 0pF, R _B = 180Ω			20	ns
			3.0V ≤ V _{DDA} , V _{DDB} ≤ 3.6V, C _{LA} = 0pF, R _A = 1kΩ, C _{LB} = 0pF, R _B = 120Ω			25	
			2.25V ≤ V _{DDA} , V _{DDB} ≤ 2.75V, C _{LA} = 0pF, R _A = 810Ω, C _{LB} = 0pF, R _B = 91Ω			35	
	t _{PHLAB}	I/OA_ = 0.5V _{DDA} to I/OB_ = 0.4V	4.5V ≤ V _{DDA} , V _{DDB} ≤ 5.5V, C _{LA} = 0pF, R _A = 1.6kΩ, C _{LB} = 0pF, R _B = 180Ω			80	
			3.0V ≤ V _{DDA} , V _{DDB} ≤ 3.6V, C _{LA} = 0pF, R _A = 1kΩ, C _{LB} = 0pF, R _B = 120Ω			95	
			2.25V ≤ V _{DDA} , V _{DDB} ≤ 2.75V, C _{LA} = 0pF, R _A = 810Ω, C _{LB} = 0pF, R _B = 91Ω			110	

Dynamic Characteristics (continued)

$V_{DDA} - V_{GNDA} = +2.25V$ to $+5.5V$, $V_{DDB} - V_{GNDB} = +2.25V$ to $+5.5V$, $T_A = -40^{\circ}C$ to $+125^{\circ}C$, unless otherwise noted. Typical values are at $V_{DDA} - V_{GNDA} = +3.3V$, $V_{DDB} - V_{GNDB} = +3.3V$, $V_{GNDA} = V_{GNDB}$, $T_A = +25^{\circ}C$, unless otherwise noted. (Note 5)

PARAMETER	SYMBOL	CONDITIONS	MIN	TYP	MAX	UNITS
Propagation Delay (Figure 1)	t_{PLHBA}	$I/OB_{-} = 0.5V_{DDB}$ to $I/OA_{-} = 0.7V_{DDA}$	$4.5V \leq V_{DDA}, V_{DDB} \leq 5.5V,$ $C_{LA} = 0pF, R_A = 1.6k\Omega,$ $C_{LB} = 0pF, R_B = 180\Omega$		25	ns
			$3.0V \leq V_{DDA}, V_{DDB} \leq 3.6V,$ $C_{LA} = 0pF, R_A = 1k\Omega,$ $C_{LB} = 0pF, R_B = 120\Omega$		25	
			$2.25V \leq V_{DDA}, V_{DDB} \leq 2.75V,$ $C_{LA} = 0pF, R_A = 810\Omega,$ $C_{LB} = 0pF, R_B = 91\Omega$		35	
	t_{PHLBA}	$I/OB_{-} = 0.5V_{DDB}$ to $I/OA_{-} = 0.9V$	$4.5V \leq V_{DDA}, V_{DDB} \leq 5.5V,$ $C_{LA} = 0pF, R_A = 1.6k\Omega,$ $C_{LB} = 0pF, R_B = 180\Omega$		115	
			$3.0V \leq V_{DDA}, V_{DDB} \leq 3.6V,$ $C_{LA} = 0pF, R_A = 1k\Omega,$ $C_{LB} = 0pF, R_B = 120\Omega$		115	
			$2.25V \leq V_{DDA}, V_{DDB} \leq 2.75V,$ $C_{LA} = 0pF, R_A = 810\Omega,$ $C_{LB} = 0pF, R_B = 91\Omega$		125	
Pulse-Width Distortion	PWD _{AB}	$ t_{PLHAB} - t_{PHLAB} $	$4.5V \leq V_{DDA}, V_{DDB} \leq 5.5V$		65	ns
			$3.0V \leq V_{DDA}, V_{DDB} \leq 3.6V$		65	
			$2.25V \leq V_{DDA}, V_{DDB} \leq 2.75V$		80	
	PWD _{BA}	$ t_{PLHBA} - t_{PHLBA} $	$4.5V \leq V_{DDA}, V_{DDB} \leq 5.5V$		95	
			$3.0V \leq V_{DDA}, V_{DDB} \leq 3.6V$		95	
			$2.25V \leq V_{DDA}, V_{DDB} \leq 2.75V$		100	

ESD Protection

PARAMETER	SYMBOL	CONDITIONS	MIN	TYP	MAX	UNITS
ESD		Human body model, all pins		±4		kV

Note 2: All devices are 100% production tested at $T_A = +125^{\circ}C$. Specifications over temperature are guaranteed by design.

Note 3: All currents into the device are positive; all currents out of the device are negative. All voltages are referenced to ground on the corresponding side of the device, unless otherwise noted.

Note 4: This is the minimum difference between the output logic-low level and the input logic threshold. This ensures that there is no possibility of the part latching up the bus to which it is connected.

Note 5: Not production tested. Guaranteed by design.

Note 6: CMTI is the maximum sustainable common-mode voltage slew rate while maintaining operation. CMTI applies to both rising and falling common-mode voltage edges. Tested with the transient generator connected between GNDA and GNDB ($V_{CM} = 1000V$).

Safety Regulatory Approvals Pending

UL
The MAX14933 is certified under UL1577. For more details, refer to file E351759.
Rated up to 3750V _{RMS} isolation voltage for single protection.
CUL (EQUIVALENT TO CSA NOTICE 5A)
The MAX14933 are certified up to 3750V _{RMS} for single protection. For more details, refer to file 351759.
VDE
The MAX14933 is certified to DIN V VDE V 0884-10 (VDE V 0884-10): 2006-12. For details, see file ref. 5015017-4880-0001/217630/EC22/SCT. Basic Insulation, Maximum Transient Isolation Voltage 4600V _{PK} , Maximum Working Voltage 443V _{RMS}

IEC Insulation Testing

TUV
The MAX14933 are tested under TUV.
IEC 60950-1: Up to 630VP (443V _{RMS}) working voltage for basic insulation.
IEC 61010-1 (ed. 3): Up to 443V _{RMS} working voltage for basic insulation. For details, see Technical Report number 095-72100581-100.
IEC 60601-1 (ed. 3): For details, see Technical Report number 095-72100581-200.
Basic Insulation 1 MOOP, 630V _{PK} (443V _{RMS})
Withstand Isolation Voltage for 60s (Viso) 2750V _{RMS}

Insulation Characteristics

PARAMETER	SYMBOL	CONDITIONS	VALUE	UNITS
Partial Discharge Test Voltage	V _{PR}	Method B1 = V _{IORM} × 1.875 (t = 1s, partial discharge < 5pC)	1182	V _P
Maximum Repetitive Peak Isolation Voltage	V _{IORM}		630	V _P
Maximum Working Isolation Voltage	V _{IOWM}		443	V _{RMS}
Maximum Transient Isolation Voltage	V _{IOTM}	t = 1s	4600	V _P
Maximum Withstand Isolation Voltage	V _{ISO}	f _{SW} = 60Hz, duration = 60s	2750	V _{RMS}
Maximum Surge Isolation Voltage	V _{IOSM}	Basic insulation 1.2/50μ pulse	10	kV
Insulation Resistance	R _S	T _A = +150°C V _{IO} = 500V	> 10 ¹²	Ω
Barrier Capacitance Input-to-Output (Note 7)	CIO	f _{SW} = 1MHz	2	pF
Minimum Creepage Distance	CPG	Wide SOIC	8	mm
		Narrow SOIC	4	
Minimum Clearance Distance	CLR	Wide SOIC	8	mm
		Narrow SOIC	4	
Internal Clearance		Distance through insulation	0.015	mm
Comparative Tracking Resistance Index	CTI	Material Group II (IEC 60112)	575	
Climatic Category			40/125/21	
Pollution Degree (DIN VDE 0110, Table 1)			2	

Note 7: Capacitance is measured with all pins on side A and side B tied together.

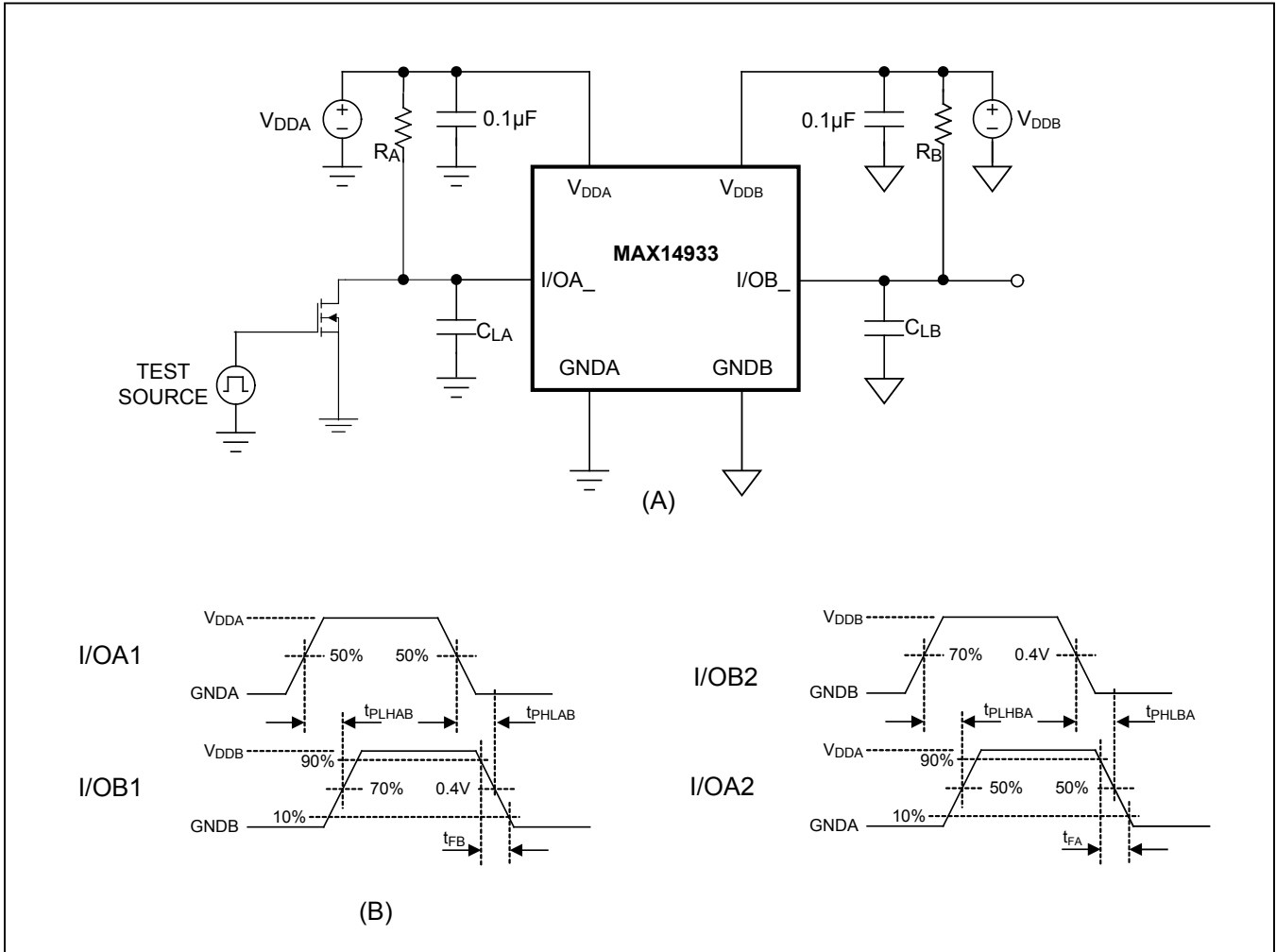
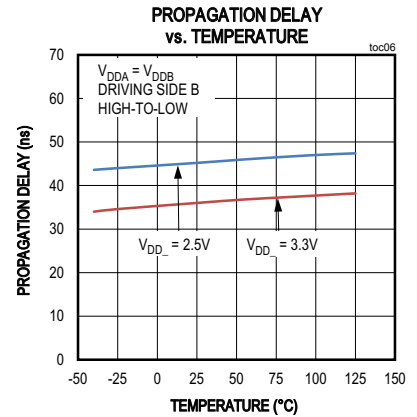
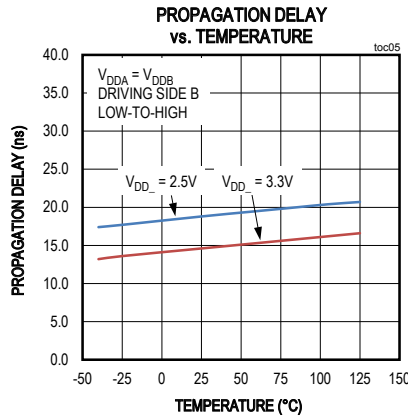
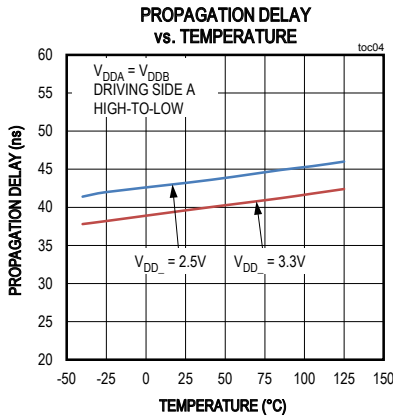
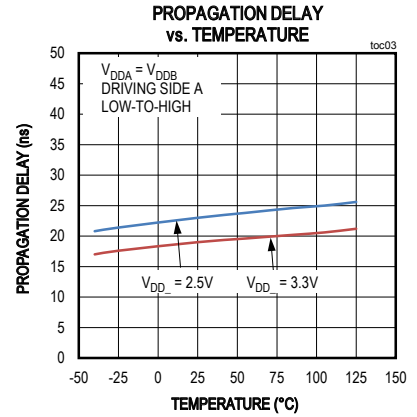
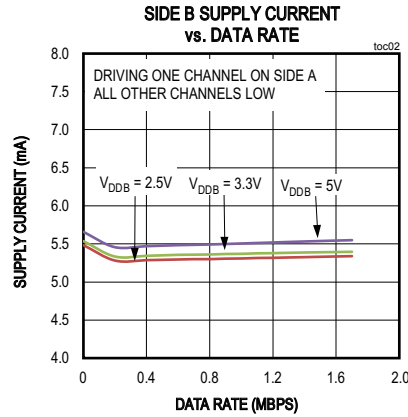
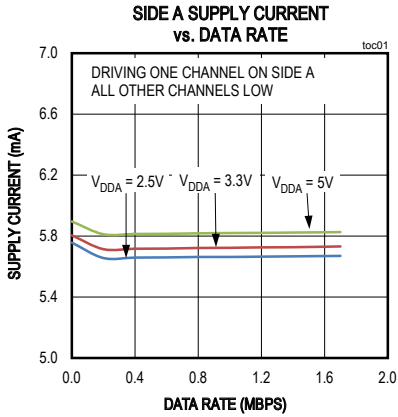

Figure 1. Test Circuit (A) and Timing Diagram (B)

Typical Operating Characteristics

V_{D_{DA}} - V_{G_{NDA}} = +3.3V, V_{D_{DB}} - V_{G_{NDB}} = +3.3V, V_{G_{NDA}} = V_{G_{NDB}}, T_A = +25°C, unless otherwise noted.



Typical Operating Characteristics (continued)

V_{DDA} - V_{GNDA} = +3.3V, V_{DDB} - V_{GNDB} = +3.3V, V_{GNDA} = V_{GNDB}, T_A = +25°C, unless otherwise noted.

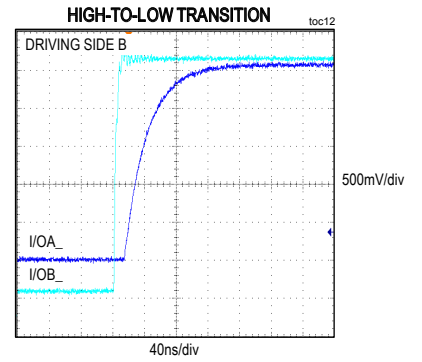
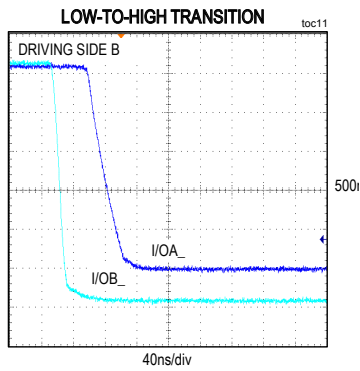
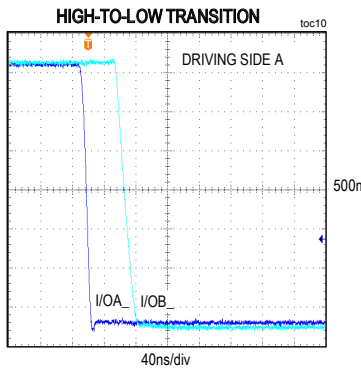
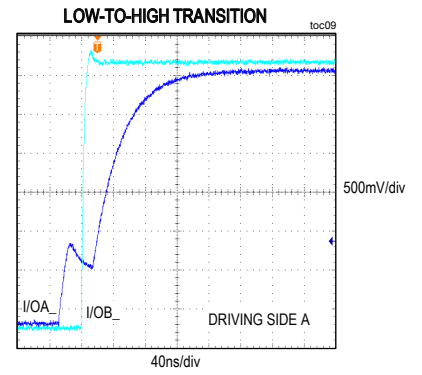
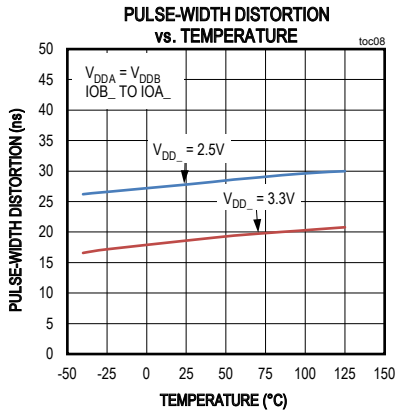
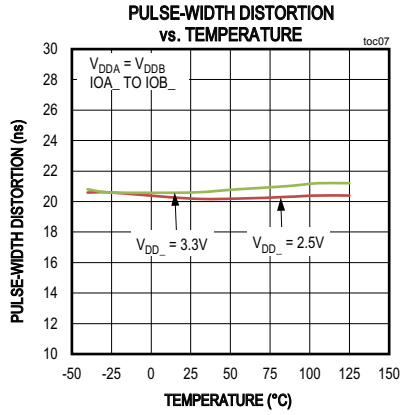

Pin Configuration

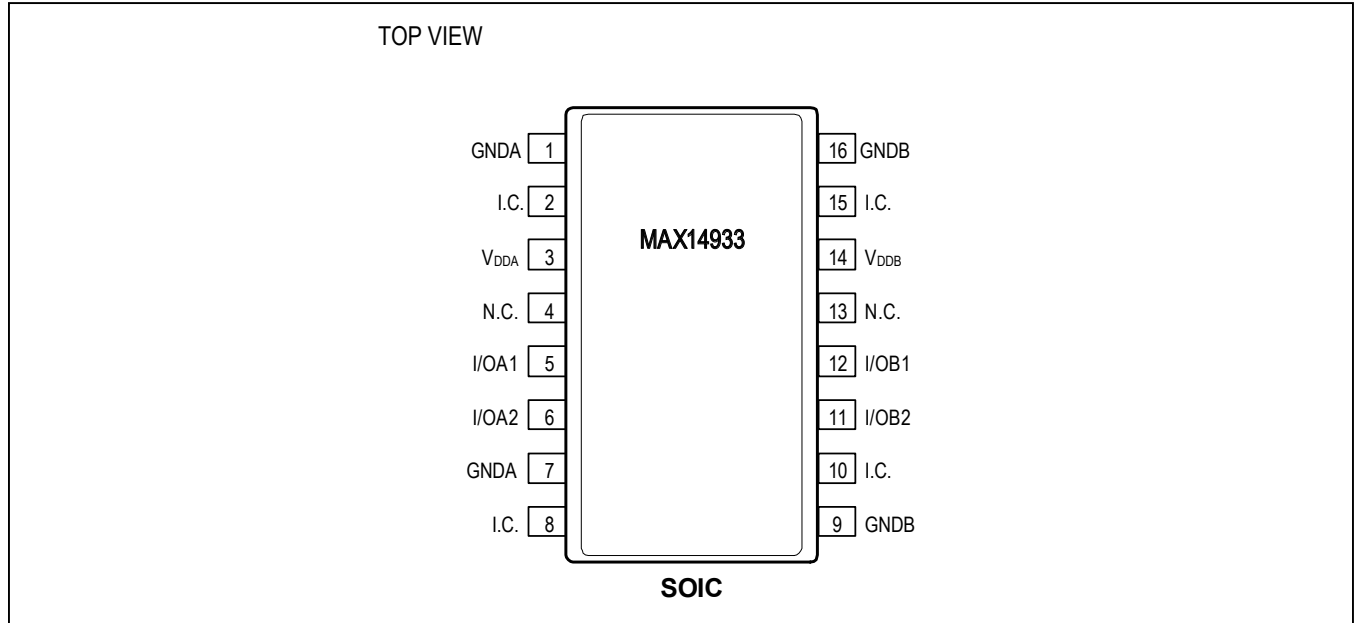

Pin Description

PIN	NAME	FUNCTION	VOLTAGE RELATIVE TO
1, 7	GNDA	Ground Reference For Side A. Ensure both pins 1 and 7 are connected to GNDA.	—
2, 8	I.C.	Internally Connected. Connect to GNDA or leave unconnected.	GNDA
4, 13	N.C.	No Connection. Not internally connected.	—
3	V _{DDA}	Power Supply. Bypass V _{DDA} with a 0.1µF ceramic capacitor as close as possible to the pin.	GNDA
5	I/OA1	Bidirectional Input/Output 1 On Side A. I/OA1 is translated to/from I/OB1 and is an open-drain output.	GNDA
6	I/OA2	Bidirectional Input/Output 2 On Side A. I/OA2 is translated to/from I/OB2 and is an open-drain output.	GNDA
9, 16	GNDB	Ground Reference For Side B.	—
10, 15	I.C.	Internally Connected. Connect to GNDB or leave unconnected.	GNDB
11	I/OB2	Bidirectional Input/Output 2 On Side B. I/OB2 is translated to/from I/OA2 and is an open-drain output.	GNDB
12	I/OB1	Bidirectional Input/Output 1 On Side B. I/OB1 is translated to/from I/OA1 and is an open-drain output.	GNDB
14	V _{DDB}	Power Supply. Bypass V _{DDB} with a 0.1µF ceramic capacitor as close as possible to the pin.	GNDB

Typical Application Circuit

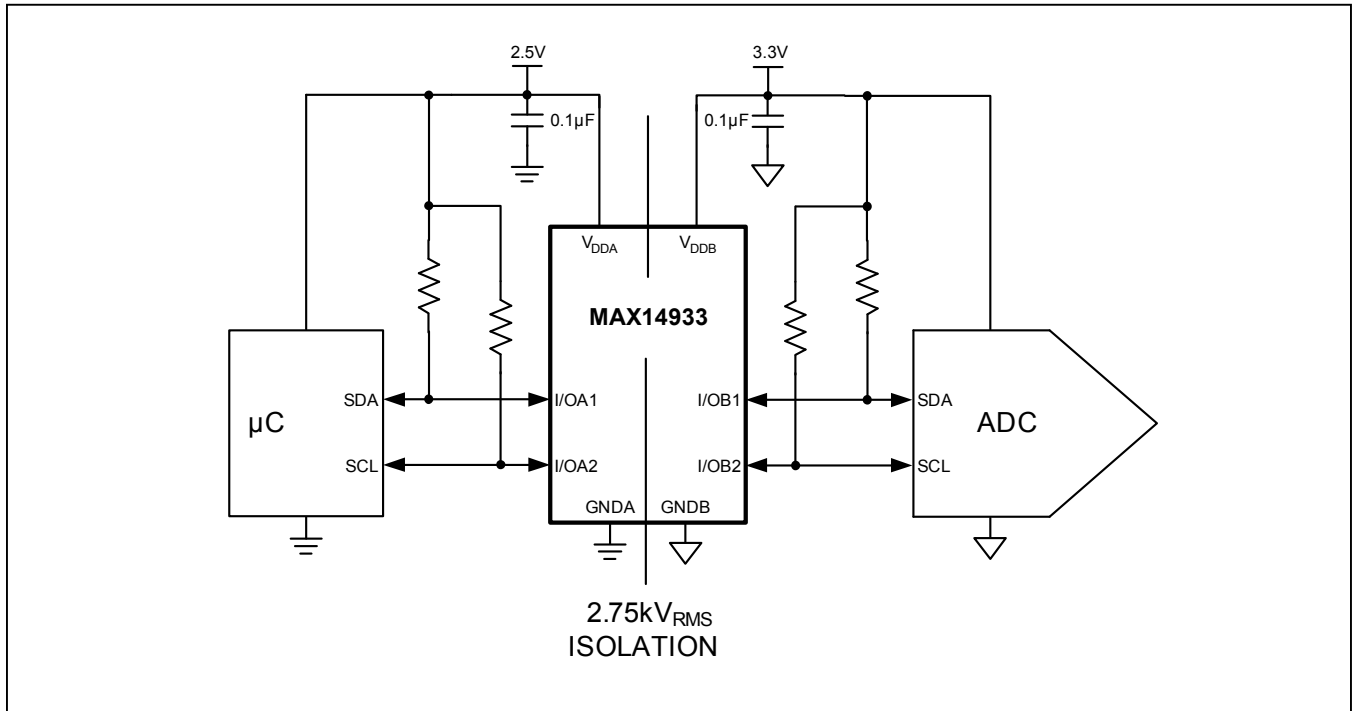

Detailed Description

The MAX14933 is a two-channel, 2.75kV_{RMS} I²C isolator utilizing Maxim's proprietary process technology. For applications requiring 5kV_{RMS} of isolation, refer to the MAX14937 data sheet. The device transfers digital signals between circuits with different power domains at ambient temperatures up to +125°C.

The device offers two bidirectional, open-drain channels for applications, such as I²C, that require data to be transmitted in both directions on the same line.

The device features independent 2.25V to 5.5V supplies on each side of the isolator. The device operates from DC to 1.7MHz and can be used in isolated I²C busses with clock stretching. The wide temperature range and high isolation voltage make the device ideal for use in harsh industrial environments.

Digital Isolation

The device provides galvanic isolation for digital signals that are transmitted between two ground domains. Up to 630V_{PEAK} of continuous isolation is supported, as well as transient differences of up to 2.75kV_{RMS} for up to 60s.

Bidirectional Channels

The device features two bidirectional channels that have open-drain outputs. The bidirectional channels do not require a direction-control input. A logic-low on one side causes the corresponding pin on the other side to be pulled low while avoiding data-latching within the device. The input logic-low thresholds (V_{IL}) of I/OA1 and I/OA2 are at least 50mV lower than the output logic-low voltages of I/OA1 and I/OA2. This prevents an output logic-low on side A from being accepted as an input low and subsequently transmitted to side B, thus preventing a latching action. The I/OA1, I/OA2, I/OB1, and I/OB2 pins have open-drain outputs, requiring pullup resistors to their respective supplies for logic-high outputs. The output low voltages are guaranteed for sink currents of up to 30mA for side B, and 3mA for side A (see the [Electrical Characteristics](#) table). The device supports I²C clock stretching.

Startup and Undervoltage Lockout

The V_{DDA} and V_{DDB} supplies are both internally monitored for undervoltage conditions. Undervoltage events can occur during power-up, power-down, or during normal operation due to a sagging supply voltage. When an undervoltage event is detected on either of the supplies, all bidirectional outputs become high impedance and are pulled high by the external pullup resistor on the open-drain outputs ([Table 1](#)). [Figure 2](#) through [Figure 5](#) shows the behavior of the outputs during power-up and power-down.

Applications Information

Effect of Continuous Isolation on Lifetime

High-voltage conditions cause insulation to degrade over time. Higher voltages result in faster degradation. Even the high-quality insulating material used in the device can degrade over long periods of time with a constant high voltage across the isolation barrier.

Power-Supply Sequencing

The MAX14933 does not require special power-supply sequencing. The logic levels are set independently on either side by V_{DDA} and V_{DDB}. Each supply can be present over the entire specified range regardless of the level or presence of the other supply.

Power-Supply Decoupling

To reduce ripple and the chance of introducing data errors, bypass V_{DDA} and V_{DDB} with 0.1μF ceramic capacitors to GNDA and GNDB, respectively. Place the bypass capacitors as close as possible to the power-supply input pins.

Input/Output Capacitive Loads

For optimal performance, ensure that C_{LA} is ≤ 40pF and C_{LB} ≤ 400pF.

Table 1. Output Behavior During Undervoltage Conditions

V _{DDA}	V _{DDB}	V _{I/OA_}	V _{I/OB_}
Powered	Powered	1	1
Powered	Powered	0	0
Undervoltage	Powered	High-Z	X
Powered	Undervoltage	X	High-Z

X = Don't care.

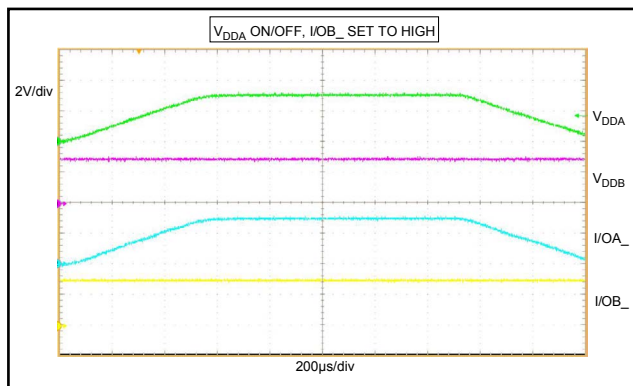

Figure 2. Undervoltage-Lockout Behavior (I/OB_ Set High)

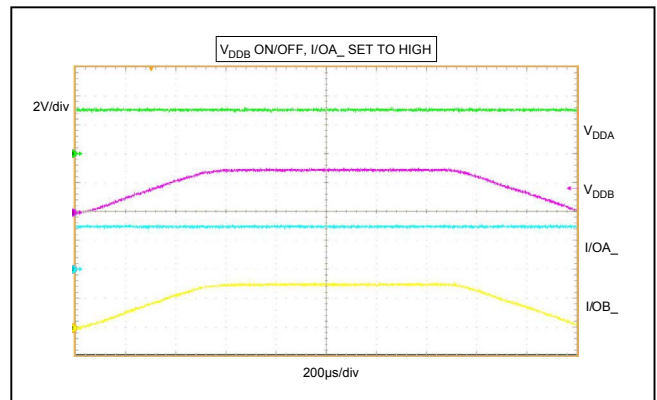

Figure 3. Undervoltage-Lockout Behavior (I/OA_ Set High)

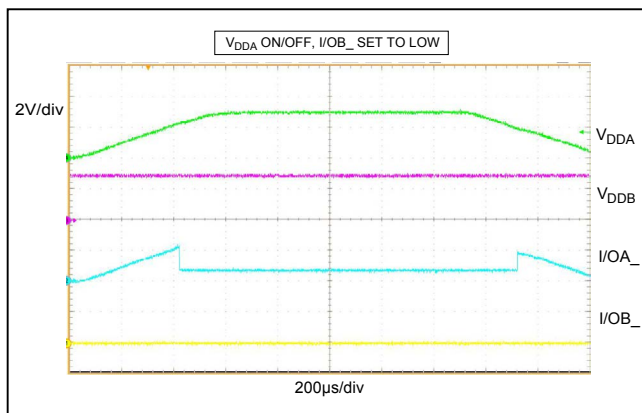

Figure 4. Undervoltage-Lockout Behavior (I/OB_ Set Low)

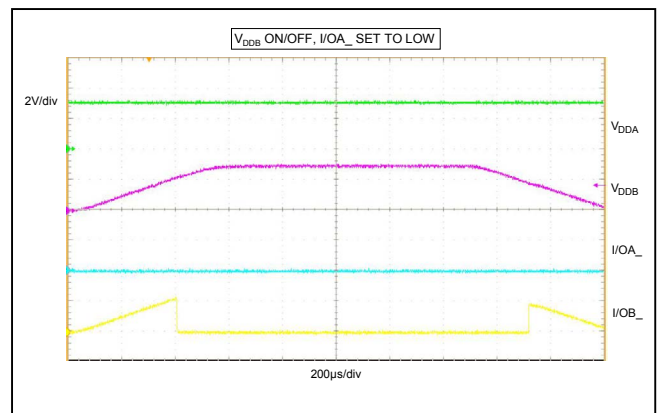

Figure 5. Undervoltage-Lockout Behavior (I/OA_ Set Low)

Ordering Information

PART	TEMP RANGE	PIN-PACKAGE
MAX14933AWE+	-40°C to +125°C	16 Wide SOIC
MAX14933ASE+	-40°C to +125°C	16 Narrow SOIC

+Denotes a lead(Pb)-free/RoHS-compliant package.

Chip Information

PROCESS: BiCMOS

Package Information

For the latest package outline information and land patterns (footprints), go to www.maximintegrated.com/packages. Note that a "+", "#", or "-" in the package code indicates RoHS status only. Package drawings may show a different suffix character, but the drawing pertains to the package regardless of RoHS status.

PACKAGE TYPE	PACKAGE CODE	OUTLINE NO.	LAND PATTERN NO.
16 Wide SOIC	W16M+8	21-0042	90-0107
16 Narrow SOIC	S16M+11	21-0041	90-0097

Revision History

REVISION NUMBER	REVISION DATE	DESCRIPTION	PAGES CHANGED
0	4/16	Initial release	—
1	5/16	Added <i>IEC Insulation Testing</i> table	1, 6
2	1/17	Removed VDE pending and future product status of MAX14933	6, 14

For pricing, delivery, and ordering information, please contact Maxim Direct at 1-888-629-4642, or visit Maxim Integrated's website at www.maximintegrated.com.

Maxim Integrated cannot assume responsibility for use of any circuitry other than circuitry entirely embodied in a Maxim Integrated product. No circuit patent licenses are implied. Maxim Integrated reserves the right to change the circuitry and specifications without notice at any time. The parametric values (min and max limits) shown in the Electrical Characteristics table are guaranteed. Other parametric values quoted in this data sheet are provided for guidance.

Looking for pricing, stock, or lifecycle information?

Click below to explore more details on WIN SOURCE:

- ⊖ [View MAX14933ASE+ on WIN SOURCE](#)
- ⊖ [Maxim Integrated Information](#)

Optimize Your Supply Chain with WIN SOURCE Solutions

- ✓ Global Sourcing Solution
- ✓ Obsolete Management
- ✓ Cost Control Management
- ✓ Shortage Management
- ✓ Alternative Solution
- ✓ Excess Inventory Management