

## *Triac (Bidirectional Triode Thyristor)*

### Features and Benefits

- Exceptional reliability
- Small fully-molded SIP package with heatsink mounting for high thermal dissipation and long life
- $V_{DRM}$  of 400 or 600 V
- 16  $A_{RMS}$  on-state current
- Uniform switching
- UL Recognized Component (File No.: E118037) (suffix I)



**Package: 3-pin SIP (TO-3PF)**



*Not to scale*

### Description

This SanKen triac (bidirectional triode thyristor) is designed for AC power control, providing reliable, uniform switching for full-cycle AC applications.

In comparison with other products on the market, the TMA16x series provides increased isolation voltage (2000  $V_{ACRMS}$ ), guaranteed for up to 1 minute, and greater peak nonrepetitive off-state voltage,  $V_{DSM}$  (700 V). In addition, commutation  $dv/dt$  and  $(dv/dt)_c$  are improved.

### Applications

- Residential and commercial appliances: vacuum cleaners, rice cookers, TVs, home entertainment
- White goods: washing machines
- Office automation power control, photocopiers
- Motor control for small tools
- Temperature control, light dimmers, electric blankets
- General use switching mode power supplies (SMPS)

### Typical Applications

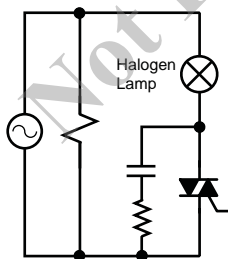

Heater control  
(for example, LBP, PPC, MFP)

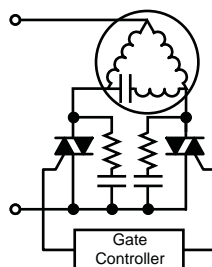

Two-phase motor control  
(for example, washing machine)

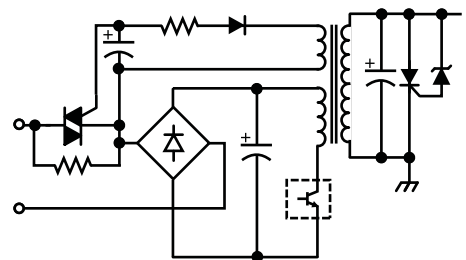

In-rush current control  
(for example, SMPS)

# TMA16xB Series

## Triac (Bidirectional Triode Thyristor)

### Selection Guide

Part Number	V <sub>DRM</sub> (V)	UL-Recognized Component	Package	Packing
TMA164B(I)	400	Yes	3-pin fully molded SIP with heatsink mount	30 pieces per tube
TMA164B-L	400	–		
TMA166B(I)	600	Yes		
TMA166B-L	600	–		

### Absolute Maximum Ratings

Characteristic	Symbol	Notes	Rating	Units	
Peak Repetitive Off-State Voltage	V <sub>DRM</sub>	TMA164Bx	R <sub>GREF</sub> = ∞	400	V
		TMA166Bx		600	V
Peak Non-Repetitive Off-State Voltage	V <sub>DSM</sub>	TMA164Bx	R <sub>GREF</sub> = ∞	500	V
		TMA166Bx		700	V
Isolation Voltage	V <sub>ISO</sub>	AC RMS applied for 1 minute between lead and case	2000	V	
RMS On-State Current	I <sub>T(RMS)</sub>	50/60 Hz full cycle sine wave, total Conduction angle (α+) + (α-) = 360°, T <sub>C</sub> = 98°C	16	A	
Surge On-State Current	I <sub>TSM</sub>	f = 60 Hz	Full cycle sine wave, peak value, non-repetitive, initial T <sub>J</sub> = 125°C	190	A
		f = 50 Hz		180	A
I <sup>2</sup> t Value for Fusing	I <sup>2</sup> t	Value for 50 Hz half cycle sine wave, 1 cycle, I <sub>TSM</sub> = 180 A	160	A <sup>2</sup> •s	
Peak Gate Current	I <sub>GM</sub>	f ≥ 50 Hz, duty cycle ≤ 10%	2	A	
Peak Gate Power Dissipation	P <sub>GM</sub>	f ≥ 50 Hz, duty cycle ≤ 10%	5	W	
Average Gate Power Dissipation	P <sub>GM(AV)</sub>	T <sub>J</sub> < T <sub>J(max)</sub>	0.5	W	
Junction Temperature	T <sub>J</sub>		-40 to 125	°C	
Storage Temperature	T <sub>stg</sub>		-40 to 125	°C	

### Thermal Characteristics May require derating at maximum conditions

Characteristic	Symbol	Test Conditions	Value	Units
Package Thermal Resistance (Junction to Case)	R <sub>θJC</sub>	For AC	1.6	°C/W

### Pin-out Diagram

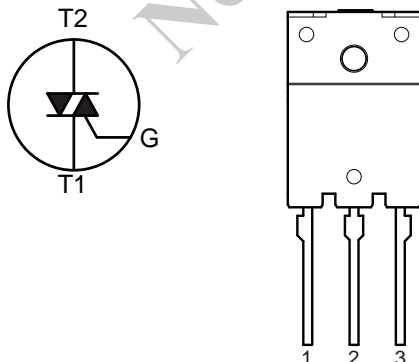

### Terminal List Table

Number	Name	Function
1	T1	Main terminal, gate referenced
2	T2	Main terminal connect to signal side
3	G	Gate control

All performance characteristics given are typical values for circuit or system baseline design only and are at the nominal operating voltage and an ambient temperature, T<sub>A</sub>, of 25°C, unless otherwise stated.

# TMA16xB Series

## Triac (Bidirectional Triode Thyristor)

### ELECTRICAL CHARACTERISTICS

Characteristics	Symbol	Test Conditions	Min.	Typ.	Max.	Unit
Off-State Leakage Current	$I_{DRM}$	$V_D = V_{DRM}, T_J = 125^\circ\text{C}, R_{GREF} = \infty$ using test circuit 1	-	-	2.0	mA
		$V_D = V_{DRM}, T_J = 25^\circ\text{C}, R_{GREF} = \infty$ using test circuit 1	-	-	100	$\mu\text{A}$
On-State Voltage	$V_{TM}$	$I_T = 20\text{ A}, T_J = 25^\circ\text{C}$	-	-	1.4	V
Gate Trigger Voltage	$V_{GT}$	Quadrant I: T2+, G+	-	-	1.5	V
		Quadrant II: T2+, G-			1.5	V
		Quadrant III: T2-, G-			1.5	V
Gate Trigger Current	$I_{GT}$	Quadrant I: T2+, G+	-	-	30	mA
		Quadrant II: T2+, G-			30	mA
		Quadrant III: T2-, G-			30	mA
Gate Non-trigger Voltage	$V_{GD}$	$V_D = V_{DRM} \times 0.5, R_L = 4\text{ k}\Omega, T_J = 125^\circ\text{C}$	0.2	-	-	V
Critical Rising Rate of Off-State Voltage during Commutation*	$(dv/dt)_c$	$T_J = 125^\circ\text{C}, V_D = 400\text{ V}, (di/dt)_c = -8\text{ A/ms}, I_{TP} = 2\text{ A}$	10	-	-	V/ $\mu\text{s}$

\*Where  $I_{TP}$  is the peak current through T2 to T1.

Test Circuit 1

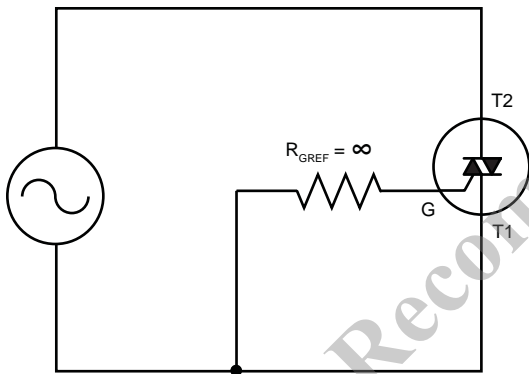

Gate Trigger Characteristics

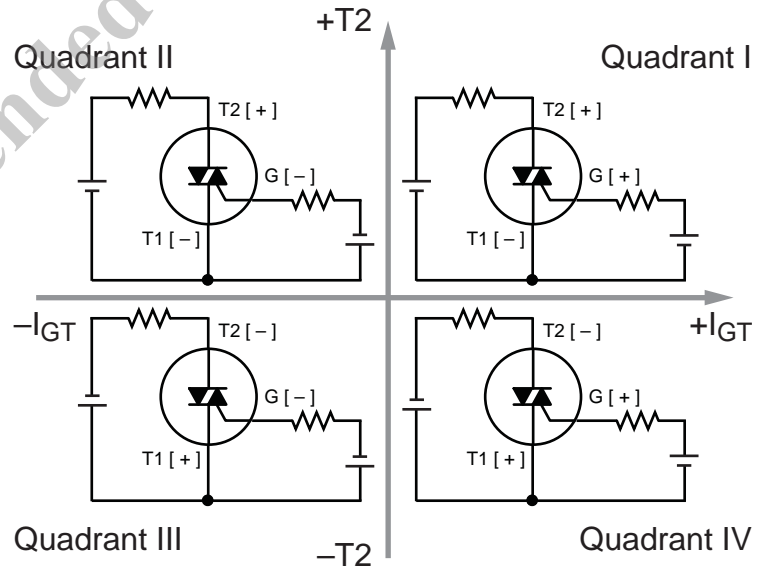

Polarities referenced to T1

Commutation Timing Diagrams

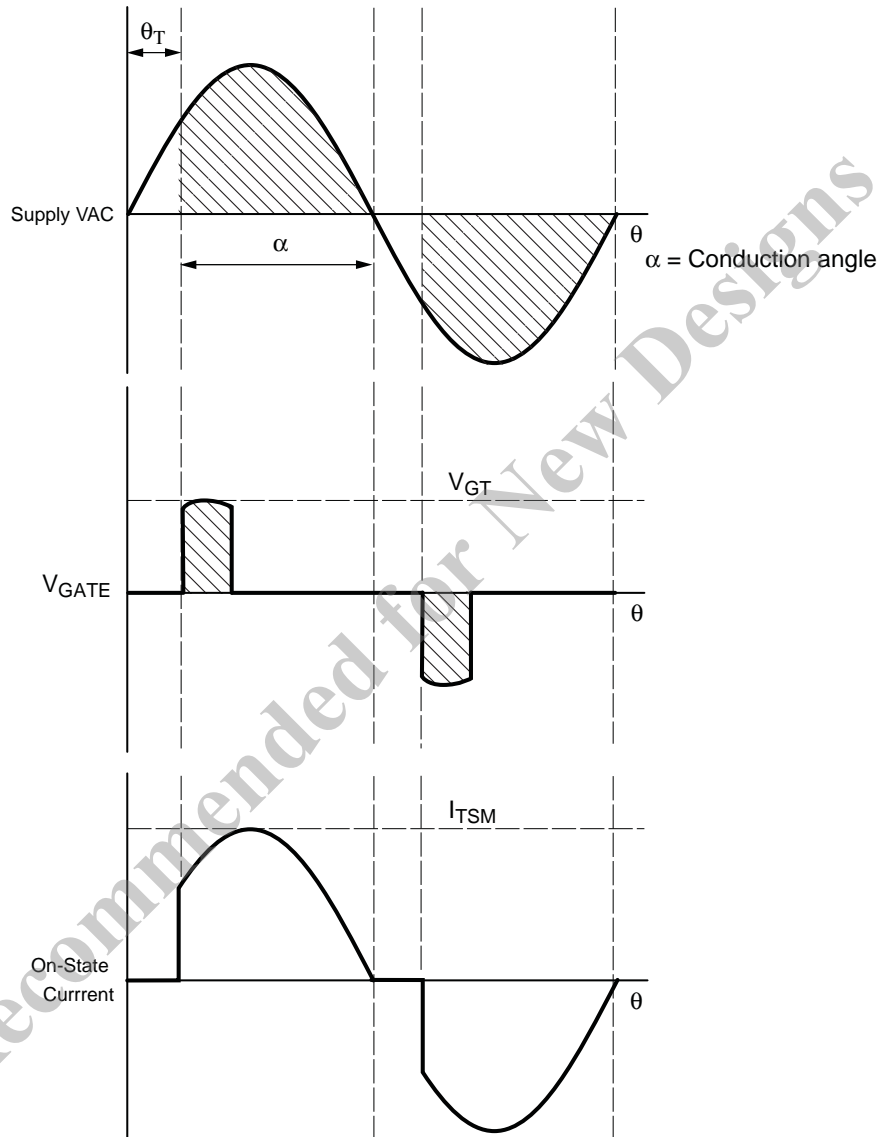

# TMA16xB Series

## Triac (Bidirectional Triode Thyristor)

### Performance Characteristics at $T_A = 25^\circ\text{C}$

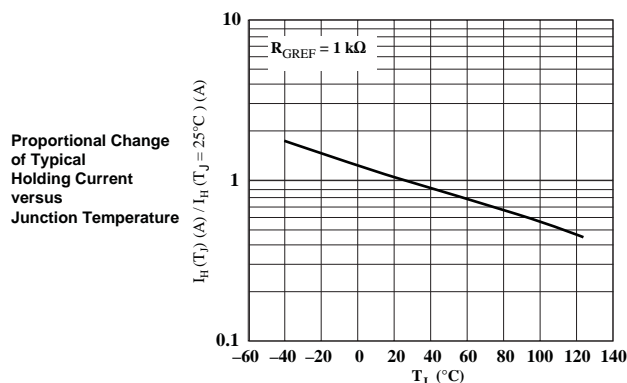
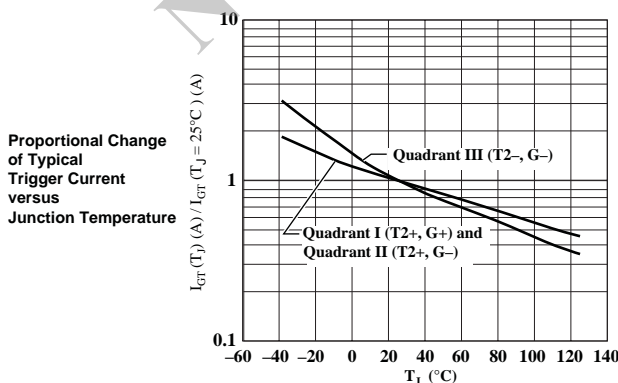
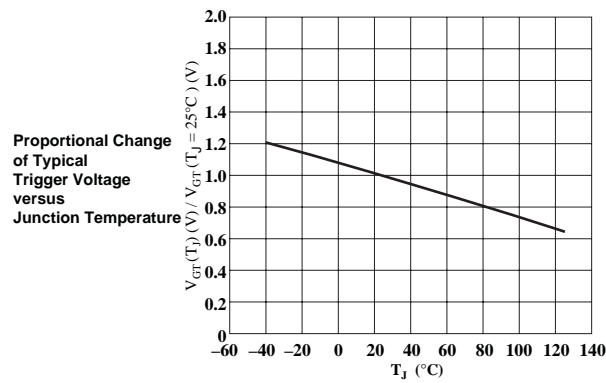
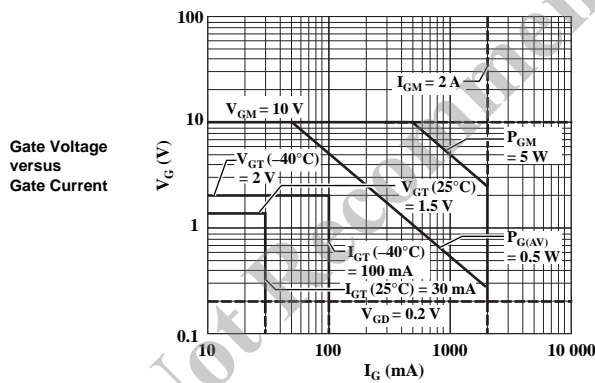
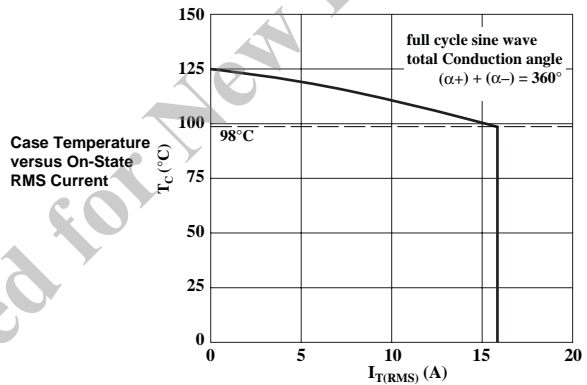
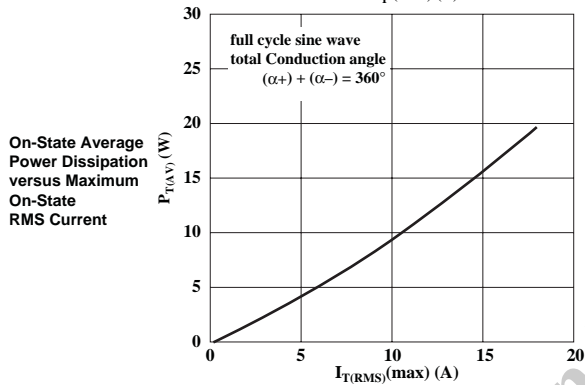
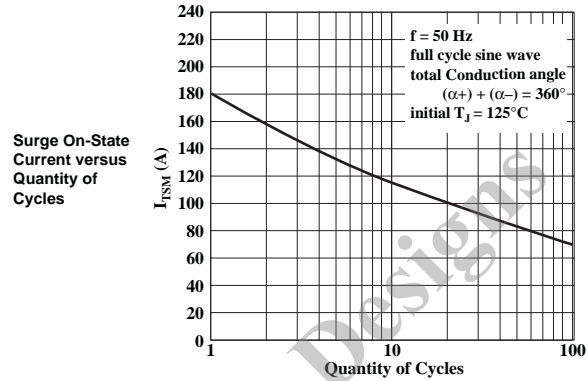
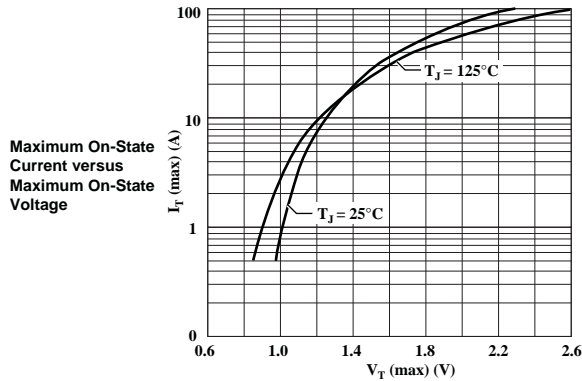

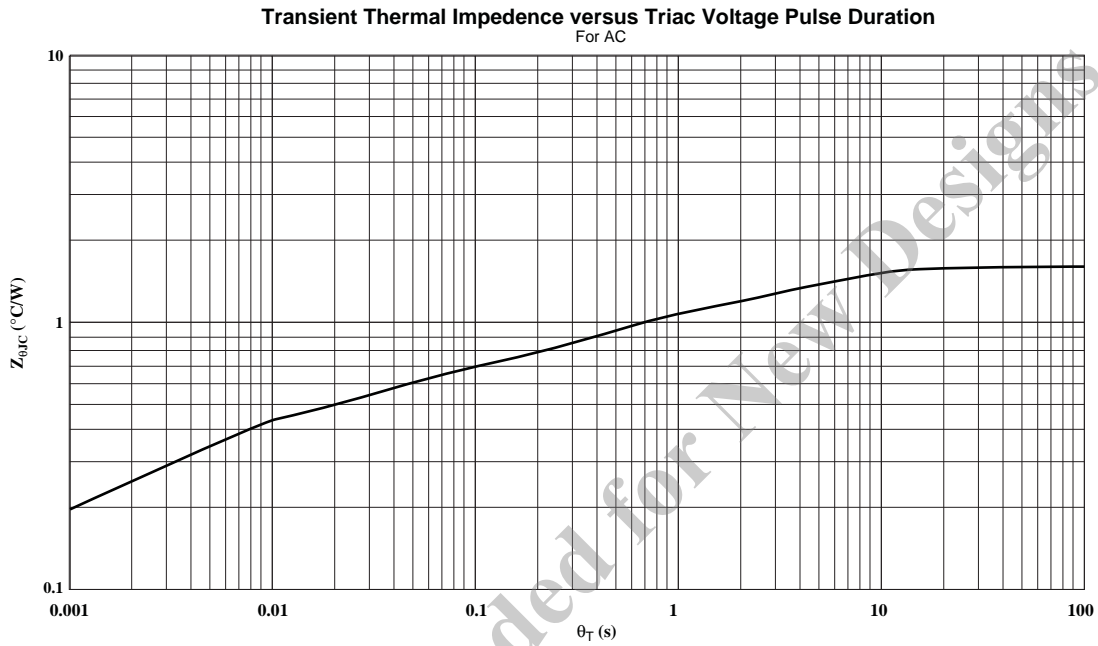

Not Recommended for New Designs



# TMA16xB Series

## Triac (Bidirectional Triode Thyristor)

### Packing Specification Tube Packing

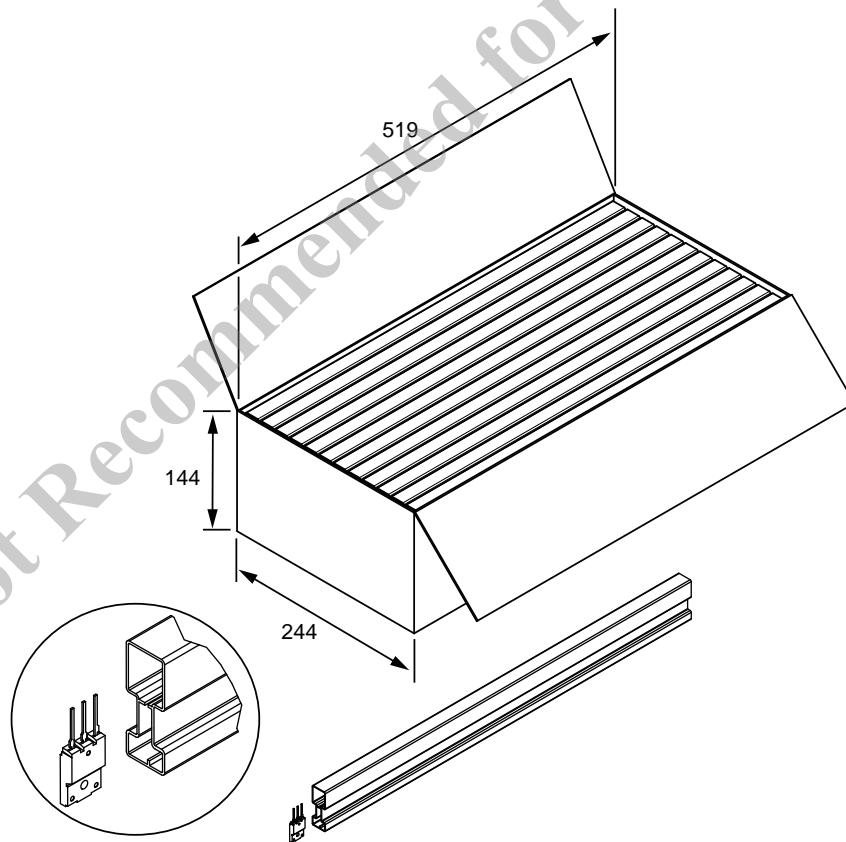
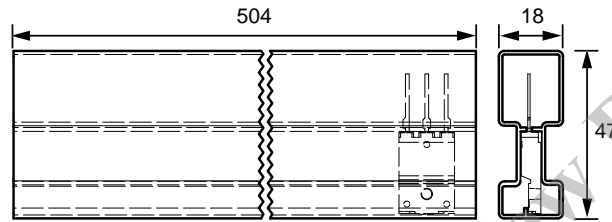

Not Recommended for New Designs

# TMA16xB Series

## Triac (Bidirectional Triode Thyristor)

### Bulk Packing

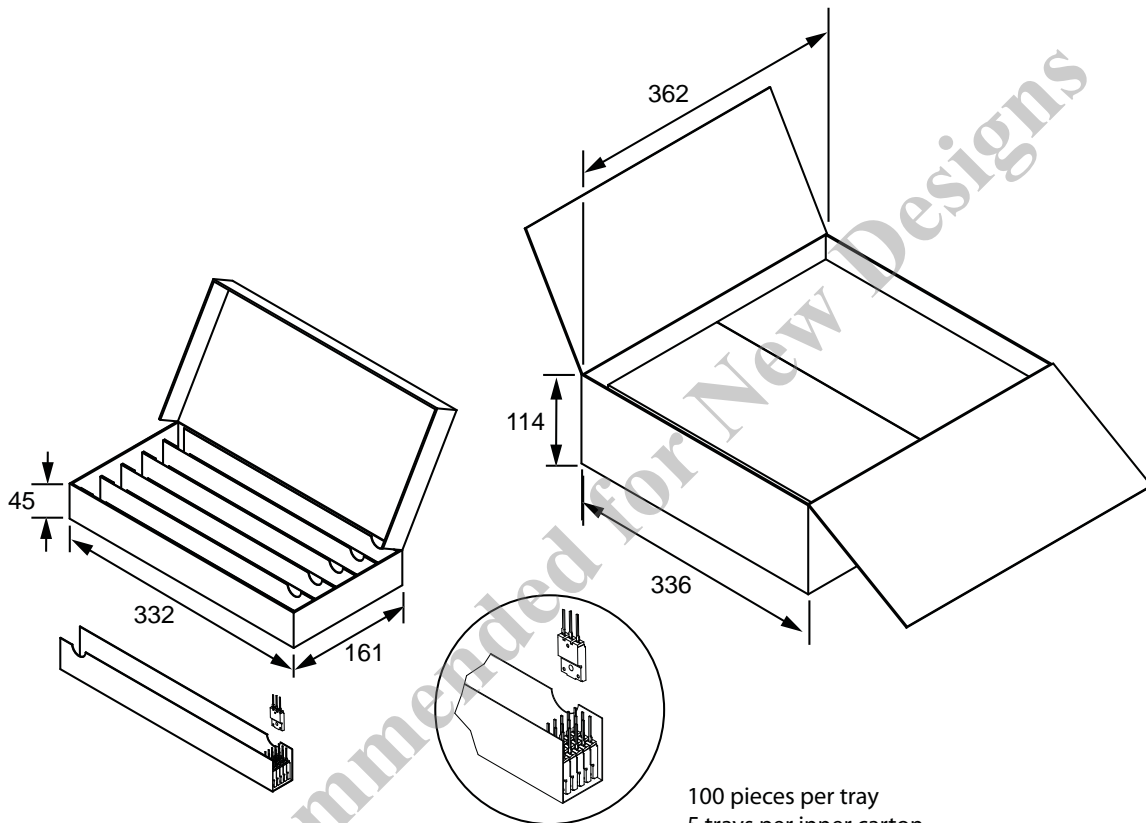

100 pieces per tray  
5 trays per inner carton  
4 inner cartons per outer carton

2000 pieces maximum per outer carton

Dimensions in millimeters

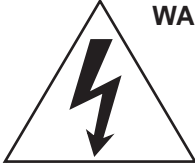

**WARNING** — These devices are designed to be operated at lethal voltages and energy levels. Circuit designs that embody these components must conform with applicable safety requirements. Precautions must be taken to prevent accidental contact with power-line potentials. Do not connect grounded test equipment.

The use of an isolation transformer is recommended during circuit development and breadboarding.

Because reliability can be affected adversely by improper storage environments and handling methods, please observe the following cautions.

#### Cautions for Storage

- Ensure that storage conditions comply with the standard temperature (5°C to 35°C) and the standard relative humidity (around 40 to 75%); avoid storage locations that experience extreme changes in temperature or humidity.
- Avoid locations where dust or harmful gases are present and avoid direct sunlight.
- Reinspect for rust on leads and solderability of products that have been stored for a long time.

#### Cautions for Testing and Handling

When tests are carried out during inspection testing and other standard test periods, protect the products from power surges from the testing device, shorts between adjacent products, and shorts to the heatsink.

#### Remarks About Using Silicone Grease with a Heatsink

- When silicone grease is used in mounting this product on a heatsink, it shall be applied evenly and thinly. If more silicone grease than required is applied, it may produce stress.
- Coat the back surface of the product and both surfaces of the insulating plate to improve heat transfer between the product and the heatsink.
- Volatile-type silicone greases may permeate the product and produce cracks after long periods of time, resulting in reduced heat radiation effect, and possibly shortening the lifetime of the product.
- Our recommended silicone greases for heat radiation purposes, which will not cause any adverse effect on the product life, are indicated below:

Type	Suppliers
G746	Shin-Etsu Chemical Co., Ltd.
YG6260	Momentive Performance Materials
SC102	Dow Corning Toray Silicone Co., Ltd.

#### Heatsink Mounting Method

- **Torque When Tightening Mounting Screws.** Thermal resistance increases when tightening torque is low, and radiation effects are decreased. When the torque is too high, the screw can strip, the heatsink can be deformed, and distortion can arise in the product frame. To avoid these problems, observe the recommended tightening torques for this product package type 0.686 to 0.882 N•m (7 to 9 kgf•cm).
- **Diameter of Heatsink Hole:** < 4 mm. The deflection of the press mold when making the hole may cause the case material to crack at the joint with the heatsink. Please pay special attention for this effect.

#### Soldering

- When soldering the products, please be sure to minimize the working time, within the following limits:  
260±5°C 10 s  
350±5°C 3 s
- Soldering iron should be at a distance of at least 1.5 mm from the body of the products

#### Electrostatic Discharge

- When handling the products, operator must be grounded. Grounded wrist straps worn should have at least 1 MΩ of resistance to ground to prevent shock hazard.
- Workbenches where the products are handled should be grounded and be provided with conductive table and floor mats.
- When using measuring equipment such as a curve tracer, the equipment should be grounded.
- When soldering the products, the head of soldering irons or the solder bath must be grounded in order to prevent leak voltages generated by them from being applied to the products.
- The products should always be stored and transported in our shipping containers or conductive containers, or be wrapped in aluminum foil.

---

The products described herein are manufactured in Japan by SanKen Electric Co., Ltd. for sale by Allegro MicroSystems, Inc.

SanKen and Allegro reserve the right to make, from time to time, such departures from the detail specifications as may be required to permit improvements in the performance, reliability, or manufacturability of its products. Therefore, the user is cautioned to verify that the information in this publication is current before placing any order.

When using the products described herein, the applicability and suitability of such products for the intended purpose shall be reviewed at the users responsibility.

Although SanKen undertakes to enhance the quality and reliability of its products, the occurrence of failure and defect of semiconductor products at a certain rate is inevitable.

Users of SanKen products are requested to take, at their own risk, preventative measures including safety design of the equipment or systems against any possible injury, death, fires or damages to society due to device failure or malfunction.

SanKen products listed in this publication are designed and intended for use as components in general-purpose electronic equipment or apparatus (home appliances, office equipment, telecommunication equipment, measuring equipment, etc.). Their use in any application requiring radiation hardness assurance (e.g., aerospace equipment) is not supported.

When considering the use of SanKen products in applications where higher reliability is required (transportation equipment and its control systems or equipment, fire- or burglar-alarm systems, various safety devices, etc.), contact a company sales representative to discuss and obtain written confirmation of your specifications.

The use of SanKen products without the written consent of SanKen in applications where extremely high reliability is required (aerospace equipment, nuclear power-control stations, life-support systems, etc.) is strictly prohibited.

The information included herein is believed to be accurate and reliable. Application and operation examples described in this publication are given for reference only and SanKen and Allegro assume no responsibility for any infringement of industrial property rights, intellectual property rights, or any other rights of SanKen or Allegro or any third party that may result from its use.

Anti radioactive ray design is not considered for the products listed herein.

### Worldwide Contacts

#### Asia-Pacific

##### China

###### **Sanken Electric Hong Kong Co., Ltd.**

Suite 1026, Ocean Centre  
Canton Road, Tsimshatsui  
Kowloon, Hong Kong

Tel: 852-2735-5262, Fax: 852-2735-5494

###### **Sanken Electric (Shanghai) Co., Ltd.**

Room 3202, Maxdo Centre  
Xingyi Road 8, Changning District  
Shanghai, China

Tel: 86-21-5208-1177, Fax: 86-21-5208-1757

###### **Taiwan Sanken Electric Co., Ltd.**

Room 1801, 18th Floor  
88 Jung Shiau East Road, Sec. 2  
Taipei 100, Taiwan R.O.C.

Tel: 886-2-2356-8161, Fax: 886-2-2356-8261

##### Japan

###### **Sanken Electric Co., Ltd. Overseas Sales Headquarters**

Metropolitan Plaza Building  
1-11-1 Nishi-Ikebukuro, Toshima-ku  
Tokyo 171-0021, Japan

Tel: 81-3-3986-6164, Fax: 81-3-3986-8637

##### Korea

###### **Sanken Electric Korea Co., Ltd.**

Samsung Life Yeouido Building 16F  
23-10, Yeouido-Dong, Yeongdeungpo-gu  
Seoul 150-734, Korea

Tel: 82-2-714-3700, Fax: 82-2-3272-2145

##### Singapore

###### **Sanken Electric Singapore Pte. Ltd.**

150 Beach Road, #14-03 The Gateway West  
Singapore 189720

Tel: 65-6291-4755, Fax: 65-6297-1744

##### Europe

###### **Sanken Power Systems (UK) Limited**

Pencoed Technology Park  
Pencoed, Bridgend CF35 5HY, United Kingdom  
Tel: 44-1656-869-100, Fax: 44-1656-869-162

##### North America

##### United States

###### **Allegro MicroSystems, Inc.**



115 Northeast Cutoff  
Worcester, Massachusetts 01606, U.S.A.  
Tel: 1-508-853-5000, Fax: 1-508-853-7895

###### **Allegro MicroSystems, Inc.**

14 Hughes Street, Suite B105  
Irvine, California 92618, U.S.A.  
Tel: 1-949-460-2003, Fax: 1-949-460-7837

## Looking for pricing, stock, or lifecycle information?

Click below to explore more details on WIN SOURCE:

-  [View TMA166B-L on WIN SOURCE](#)
-  [Sanken Information](#)

## Optimize Your Supply Chain with WIN SOURCE Solutions

-  Global Sourcing Solution
-  Obsolete Management
-  Cost Control Management
-  Shortage Management
-  Alternative Solution
-  Excess Inventory Management