

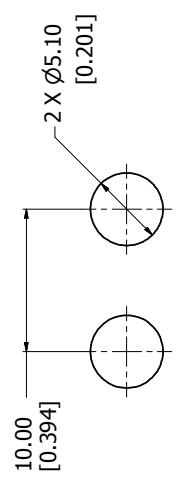

**THE DATASHEET OF
M3783-7001**



3 4 5 6 7 8



DRILLING SCHEMATIC

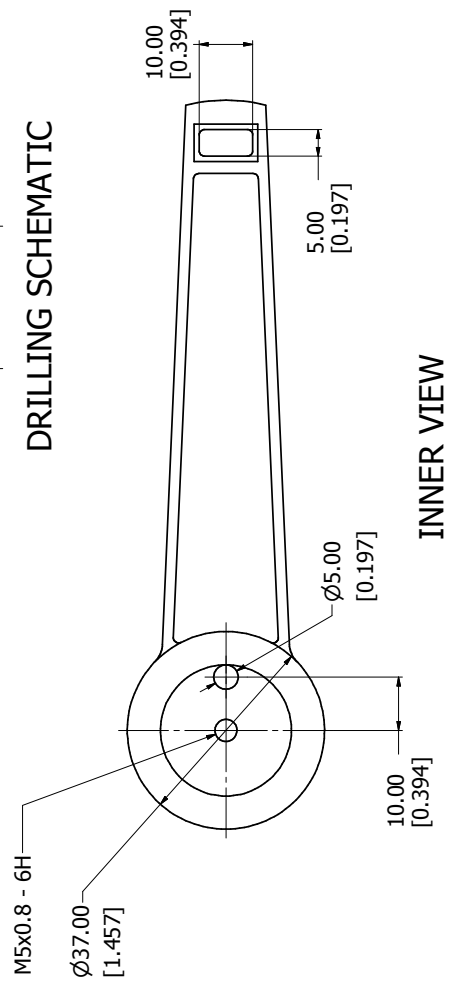

INNER VIEW

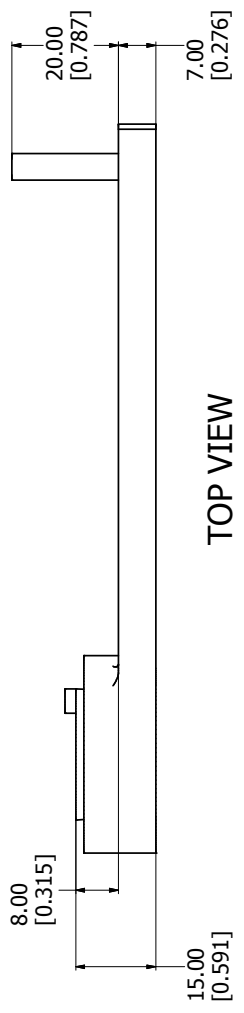

TOP VIEW

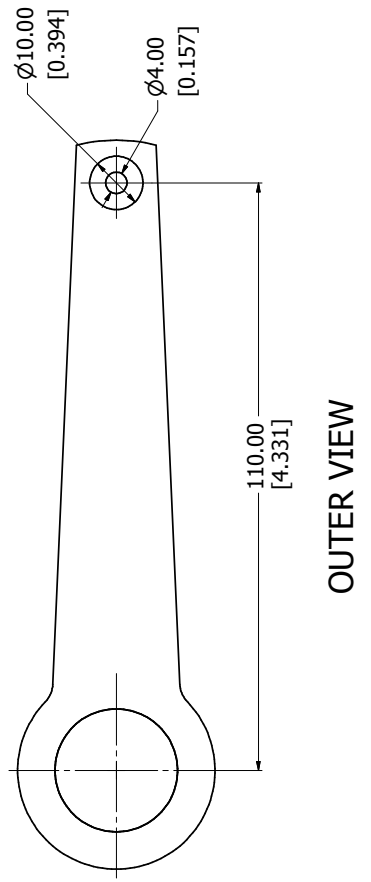

OUTER VIEW

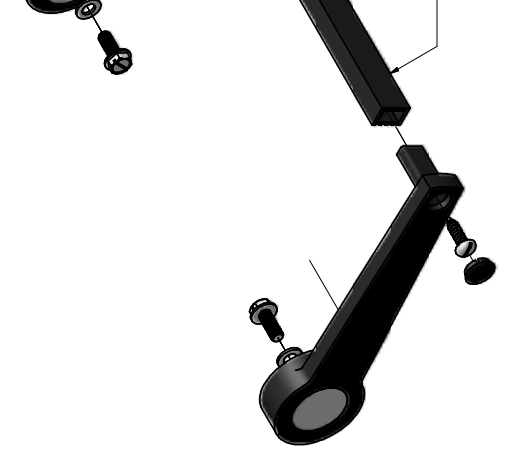

EXPLODED BAIL ASS

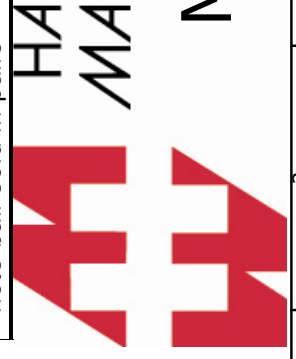

- M3**
- Handle Arm - Reinforced F
- Handle Profile - Black Anod
- F**
- 2 Screws - Hex Slotted M3
- 2 Screws - Panhead Self T
- 2 Washers
- 2 Sealing Caps
- **note bail sold in pairs



3 4 5 6 7 8

Looking for pricing, stock, or lifecycle information?

Click below to explore more details on WIN SOURCE:

-  [View M3783-7001 on WIN SOURCE](#)
-  [Hammond Manufacturing Information](#)

Optimize Your Supply Chain with WIN SOURCE Solutions

-  Global Sourcing Solution
-  Obsolete Management
-  Cost Control Management
-  Shortage Management
-  Alternative Solution
-  Excess Inventory Management