



**THE DATASHEET OF
KSL0M211LFT**



KSA & KSL Series Sealed Tact Switch



Features/Benefits

- Designed for automatic or manual insertion
- Cambered terminals to ensure self retention
- Top or side actuated
- Large choice of caps
- RoHS compliant and compatible

Typical Applications

- Automotive
- Industrial
- Telecommunication networks

Tactile Switches

Specification

CONTACT ARRANGEMENT: SPST, N.O.
 DOUBLE OVERMOLDING ON TERMINAL
 SEALING: IP60
 TERMINALS: PC pins, ground pin optional

Mechanical

Type	Actuation force N	Operating life (operations)	Travel to make
KSA0M211	1,4 ± 0,4	100,000	0,5 ± 0,2
KSA0M311	1,4 ± 0,4	1,000,000	0,5 ± 0,2
KSA0M411	3 ± 0,75	100,000	0,6 ± 0,2
KSA0M511	5 ± 1,5	100,000	0,7 ± 0,2
KSA0M911	3 ± 0,75	500,000	0,6 ± 0,2
KSL0M211	1,4 ± 0,4	100,000	0,5 ± 0,2
KSL0M311	1,4 ± 0,4	1,000,000	0,5 ± 0,2
KSL0M411	3 ± 0,75	100,000	0,6 ± 0,2
KSL0M511	5 ± 1,5	100,000	0,7 ± 0,2
KSL0M911	3 ± 0,75	500,000	0,6 ± 0,2

NOTE: Other versions in terms of force, termination length and corrosion protection available. Please contact your sales representative.
 This data sheet does not provide enough information for applications which require a certain level of quality or safety such as automotive, medical systems, safety equipment. Please contact your sales representative to get contractual specification package.

Electrical

	Silver	Gold
MAXIMUM POWER:	1 VA	0.2 VA
MAXIMUM VOLTAGE:	32 VDC	32 VDC
MINIMUM VOLTAGE:	20 mV	20 mV
MAXIMUM CURRENT:	50 mA	10 mA
MINIMUM CURRENT:	1 mA	1 mA
DIELECTRIC STRENGTH: 250 Vrms		
CONTACT RESISTANCE: ≤ 100m Ω		
INSULATION RESISTANCE (100 V): ≥ 10 ⁹ Ω		
BOUNCE TIME: ≤ 1 ms		

Environmental

	Silver	Gold
OPERATING TEMPERATURE:	-40°C to 85°C	-40°C to 125°C
STORAGE TEMPERATURE:	-40°C to 85°C	-55°C to 125°C

Process

Wave soldering compatible with lead free soldering profile.

Packaging

Can be delivered in tubes of 65 pieces for automatic insertion or in boxes of 500 pieces for manual insertion (250 pieces for KSL, KSLV, KSAV).

How To Order

Our easy build-a-switch concept allows you to mix and match options to create the switch you need. To order, select desired option from each category and place it in the appropriate box.

However, please note that all the combinations of these options are not feasible.

For any part number different from those listed above, please consult your local representative.

SWITCH

Actuator Type

A Short hard plastic

L Long hard plastic

Ground Terminal

0 Without

1 With*

Insertion

M Manual (bulk packaging)

A Automatic (tube packaging)

V Vertical (bulk packaging)*

1

Contact Material

1 Silver contacts

3 Gold contacts

Operation Force

2 1.3 N (130 grams), 100,000 operations

3 1.3 N (130 grams), 1,000,000 operations

4 3 N (300 grams), 100,000 operations

5 5 N (500 grams), 100,000 operations

9 3 N (300 grams), 500,000 operations

RoHS compliant and compatible.
Tin plated.

*Note: "1" Ground terminal not compatible with "V" insertion

BUTTONS Buttons must be ordered separately and will be supplied in bulk.

Button Style

K01 10 mm square snap-on

K02 ø8 mm round snap-on

K03 8,5 x 3,8 mm single floating

B T N — **K 0** —

Button Color

10 Dark gray **60** Blue

20 Light gray **70** Gray-blue

30 Yellow **80** Ivory

40 Red **90** Black

50 Green

KSA & KSL Series Sealed Tact Switch

ACTUATOR TYPE

KSA & KSL

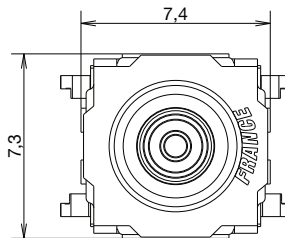
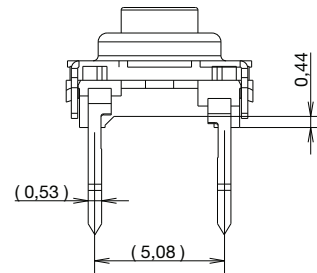
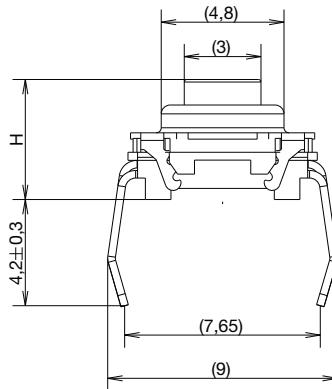
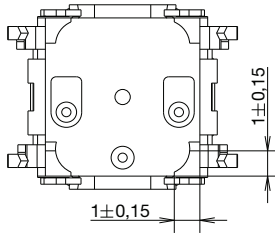

Type	H mm	inch
KSA	4,7±0,2	(.185)
KSL	9,9±0,2	(.390)

Tactile Switches

GROUND TERMINAL

0 WITHOUT

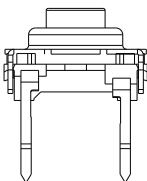

1* WITH

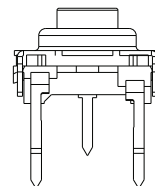

*Not compatible with "V" insertion



First Angle
Projection

Dimensions are shown: mm
Specifications and dimensions subject to change

CONTACT MATERIAL



OPTION CODE	CONTACT MATERIAL
1	Silver contacts
3	Gold contacts

SEALING



OPTION CODE	SEALING
1	Sealing level IP60

BUTTONS

Buttons must be ordered separately and will be supplied in bulk.

BUTTON TYPE	KSA	KSL	KSAV	KSLV
K01	X			
K02	X			
K03	X	X	X	X

K01

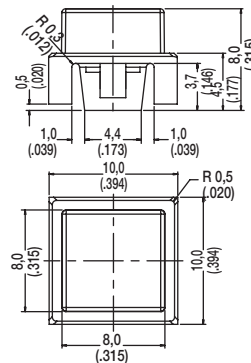
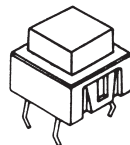

Dimensions are shown: mm
Specifications and dimensions subject to change

Looking for pricing, stock, or lifecycle information?

Click below to explore more details on WIN SOURCE:

- ⊖ [View KSL0M211LFT on WIN SOURCE](#)
- ⊖ [C&K Components Information](#)

Optimize Your Supply Chain with WIN SOURCE Solutions

- ✓ Global Sourcing Solution
- ✓ Obsolete Management
- ✓ Cost Control Management
- ✓ Shortage Management
- ✓ Alternative Solution
- ✓ Excess Inventory Management