



THE DATASHEET OF
1455B802



3 4 5 6 7 8

D

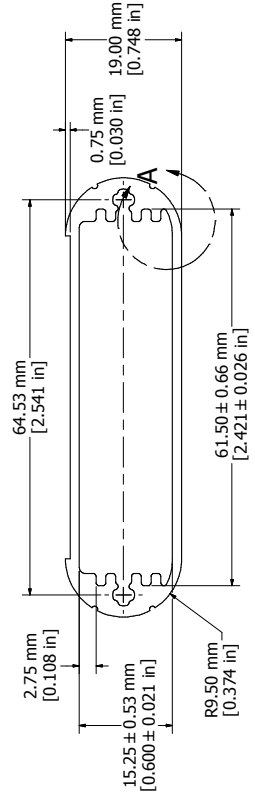

EXTRUSION

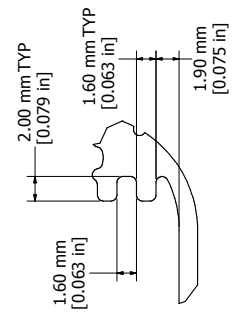

DETAIL A

****DESIGNED FOR 60MM WIDE PC BOARD****

EXP

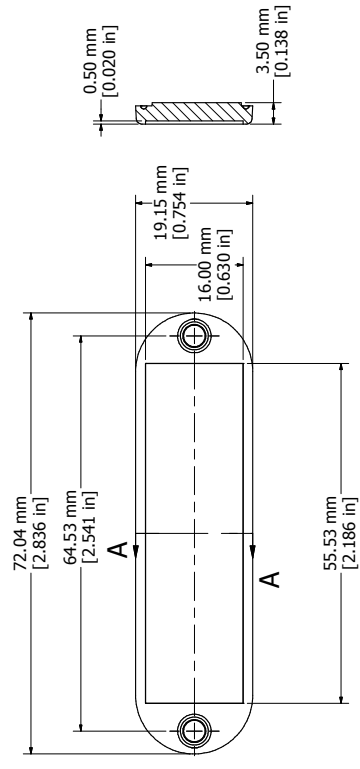
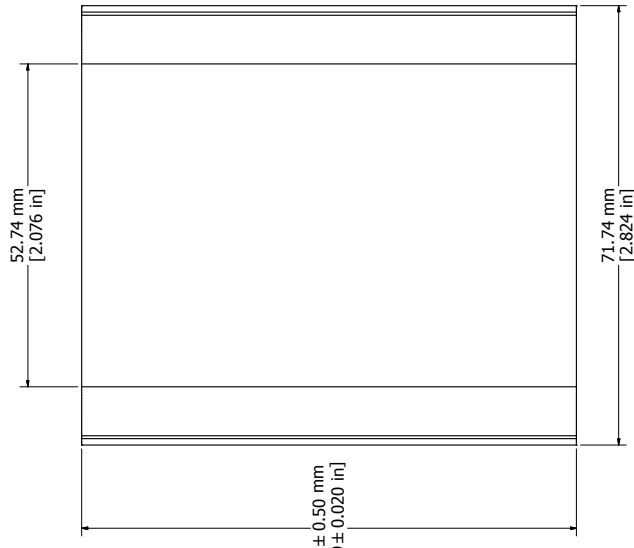

BEZEL

SECTION A-A

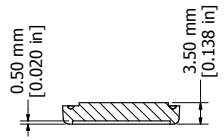

Enclosure
Solid model
Contact F

Purchase
screws at
Box made
Bezels m

C
B
E
F



A

B

C

D

E



F

EXP

3 4 5 6 7 8

Looking for pricing, stock, or lifecycle information?

Click below to explore more details on WIN SOURCE:

-  [View 1455B802 on WIN SOURCE](#)
-  [Hammond Manufacturing Information](#)

Optimize Your Supply Chain with WIN SOURCE Solutions

-  Global Sourcing Solution
-  Obsolete Management
-  Cost Control Management
-  Shortage Management
-  Alternative Solution
-  Excess Inventory Management