



**THE DATASHEET OF  
LYT0002P**



# LYT0002/0004-0006 LYTSwitch-0 Off-Line Low Power LED Driver IC Family

Lowest Component Count, Off-Line Switcher IC  
for Non-Isolated LED Lighting Applications

## Product Highlights

- High power factor meeting EU and USA requirements
- Very low component count
- Frequency jitter reduces EMI
- No bias supply or transformer required

## Cost-Effective LED driver

The LYTSwitch-0 family parts are a highly integrated combination of controller, driver and switching power MOSFET that enable low component-count, non-isolated switching topologies for highly cost competitive LED lighting applications.

66 kHz operation together with frequency jittering insures a very low-cost EMI filter. Less than <50 ms start-up time turn-on without overshoot, improves end user experience – no delay.

## Power Factor Correction

Allows designs that easily meet European and North American standards for PFC in consumer lighting applications.

## Tight CC Performance

Accurate current limit with tight line and load regulation that is stable over a wide temperature range makes the LYTSwitch-0 ideal for LED lighting applications.

## Comprehensive Protection

Integrated auto-restart for short-circuit, open-circuit and open-loop faults as well as a high threshold over-temperature protection feature (min. 135 °C) with automatic restart provide extensive protection at no additional cost.

## LYTSwitch-0 Supports Different LED Applications

Flyback, buck, buck-boost and boost architectures are all supported by the LYTSwitch-0 family. The 700 V switching power MOSFET supports an input voltage range of 85 VAC to 308 VAC.

## Description

The LYTSwitch™-0 family is specifically designed for low cost LED bulb replacement applications. LYTSwitch-0 devices integrate a 700 V power MOSFET, oscillator, simple ON/OFF control scheme, a high-voltage switched current source, frequency jittering, cycle-by-cycle current limit and thermal shutdown circuitry into a monolithic IC.

The start-up and operating power are derived directly from the voltage on the DRAIN pin. This eliminates the need for a bias supply and associated circuitry plus allowing low-cost discrete inductors to be used. The fully integrated auto-restart circuit in the LYTSwitch-0 family safely limits output power during fault conditions such as short-circuit or open-loop, reducing component count and lower system cost. Package options for thru-hole and surface-mount suit different manufacturing requirements.

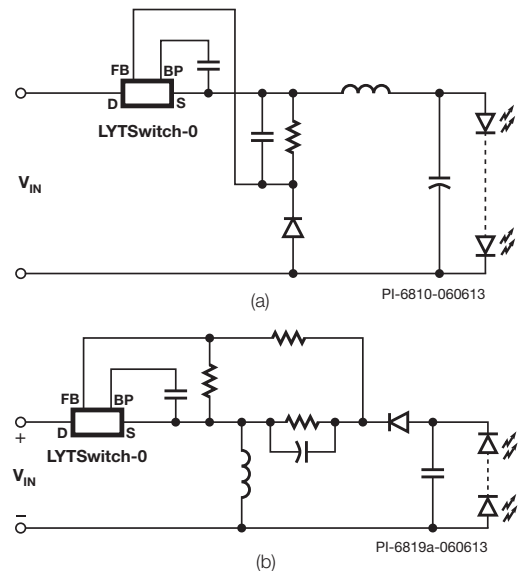

Figure 1. Typical Application Schematic (a) Buck, (b) Buck-Boost.

## Output Current Table<sup>1</sup>

Product <sup>6</sup>	PF <sup>4,5</sup>	230 VAC ±15%		85-308 VAC	
		MDCM <sup>2</sup>	CCM <sup>3</sup>	MDCM <sup>2</sup>	CCM <sup>3</sup>
LYT0002D/P	High	45 mA	65 mA	30 mA	40 mA
	Low	63 mA	80 mA	63 mA	80 mA
LYT0004D/P	High	85 mA	110 mA	50 mA	70 mA
	Low	98 mA	139 mA	98 mA	139 mA
LYT0005D/P	High	100 mA	140 mA	60 mA	90 mA
	Low	120 mA	170 mA	120 mA	170 mA
LYT0006D/P	High	165 mA	220 mA	100 mA	140 mA
	Low	200 mA	280 mA	200 mA	280 mA

Table 1. Output Current Table.

Notes:

1. Typical output current in a non-isolated buck converter. See Key Applications Considerations section for more information.
2. MDCM – mostly discontinuous mode.
3. CCM – continuous conduction mode.
4. PF high: >0.7 @ 120 VAC and >0.5 @ 230 VAC.
5. PF low: for non-PF application where  $C_{IN} > 5 \mu F$  minimum.
6. Packages: P: PDIP-8B, D: SO-8C.

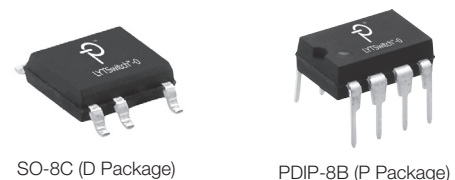

Figure 2. Package Options.

Topology	Basic Circuit Schematic	Key Features
<p>High-Side Buck – Direct Feedback</p>		<ul style="list-style-type: none"> <li>• Output referenced to input</li> <li>• Positive output (<math>V_O</math>) with respect to <math>-V_{IN}</math></li> <li>• Step down – <math>V_O &lt; V_{IN}</math></li> <li>• Low cost direct feedback (<math>\pm 5\%</math> typ.)</li> </ul>
<p>Low-Side Buck – Constant Current LED Driver; Optocoupler Feedback</p>		<ul style="list-style-type: none"> <li>• Output referenced to input</li> <li>• Negative output (<math>V_O</math>) with respect to <math>+V_{IN}</math></li> <li>• Step down – <math>V_O &lt; V_{IN}</math></li> <li>• Optocoupler feedback             <ul style="list-style-type: none"> <li>• Low-cost non-safety rated optocoupler</li> <li>• Optional Zener provides disconnected load protection</li> <li>• Accuracy determined by <math>V_F</math> variation of optocoupler LED</li> </ul> </li> </ul>
<p>High-Side Buck-Boost – Constant Current LED Driver</p>		<ul style="list-style-type: none"> <li>• Output referenced to input</li> <li>• Negative output (<math>V_O</math>) with respect to <math>+V_{IN}</math></li> <li>• Step up/down – <math>V_O &gt; V_{IN}</math> or <math>V_O &lt; V_{IN}</math></li> <li>• Low-cost direct feedback (<math>\pm 5\%</math> typ.)</li> <li>• Fail-safe – output is not subjected to input voltage if the internal power MOSFET fails</li> <li>• Ideal for driving LEDs – better accuracy and temperature stability than low-side Buck constant current LED driver</li> </ul>
<p>Low-Side Boost – Constant Current LED Driver</p>		<ul style="list-style-type: none"> <li>• Output referenced to input</li> <li>• Positive output (<math>V_O</math>) with respect to <math>-V_{IN}</math></li> <li>• Step up – <math>V_O &gt; V_{IN}</math></li> <li>• Low-cost direct feedback (<math>\pm 5\%</math> typ.)</li> <li>• Ideal for driving high-voltage LEDs string – good accuracy and temperature stability</li> </ul>
<p>Low-Side Flyback – Constant Current LED Driver</p>		<ul style="list-style-type: none"> <li>• Output referenced to input</li> <li>• Positive output (<math>V_O</math>) with respect to <math>-V_{IN}</math></li> <li>• Step down – <math>V_O &lt; V_{IN}</math></li> <li>• Low-cost direct feedback (<math>\pm 5\%</math> typ.)</li> <li>• Fail-safe – output is not subjected to input voltage if the internal power MOSFET fails</li> <li>• Ideal for driving very low voltage LEDs string – good accuracy and temperature stability</li> </ul>

Table 2. Common Circuit Configurations Using LYTSwitch-0 for Driving LEDs.

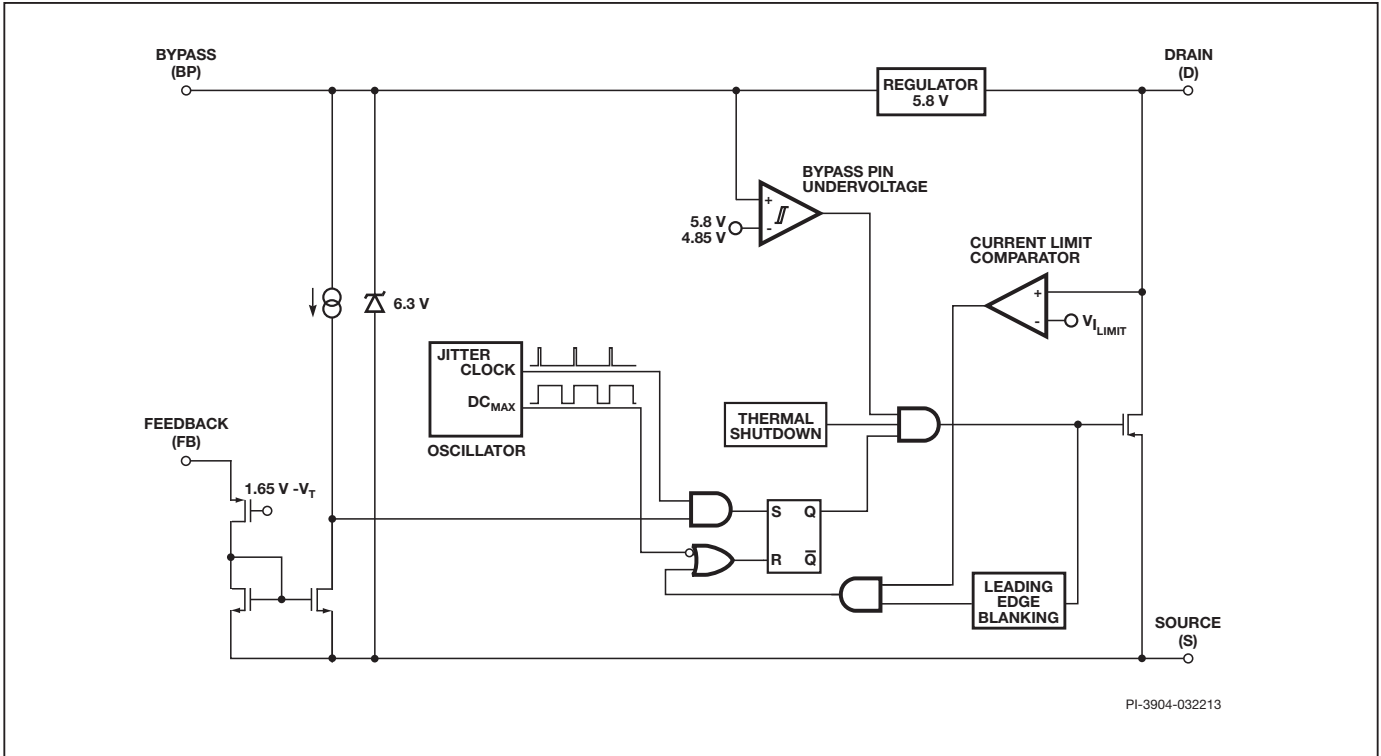

Figure 3a. Functional Block Diagram LYT0002.

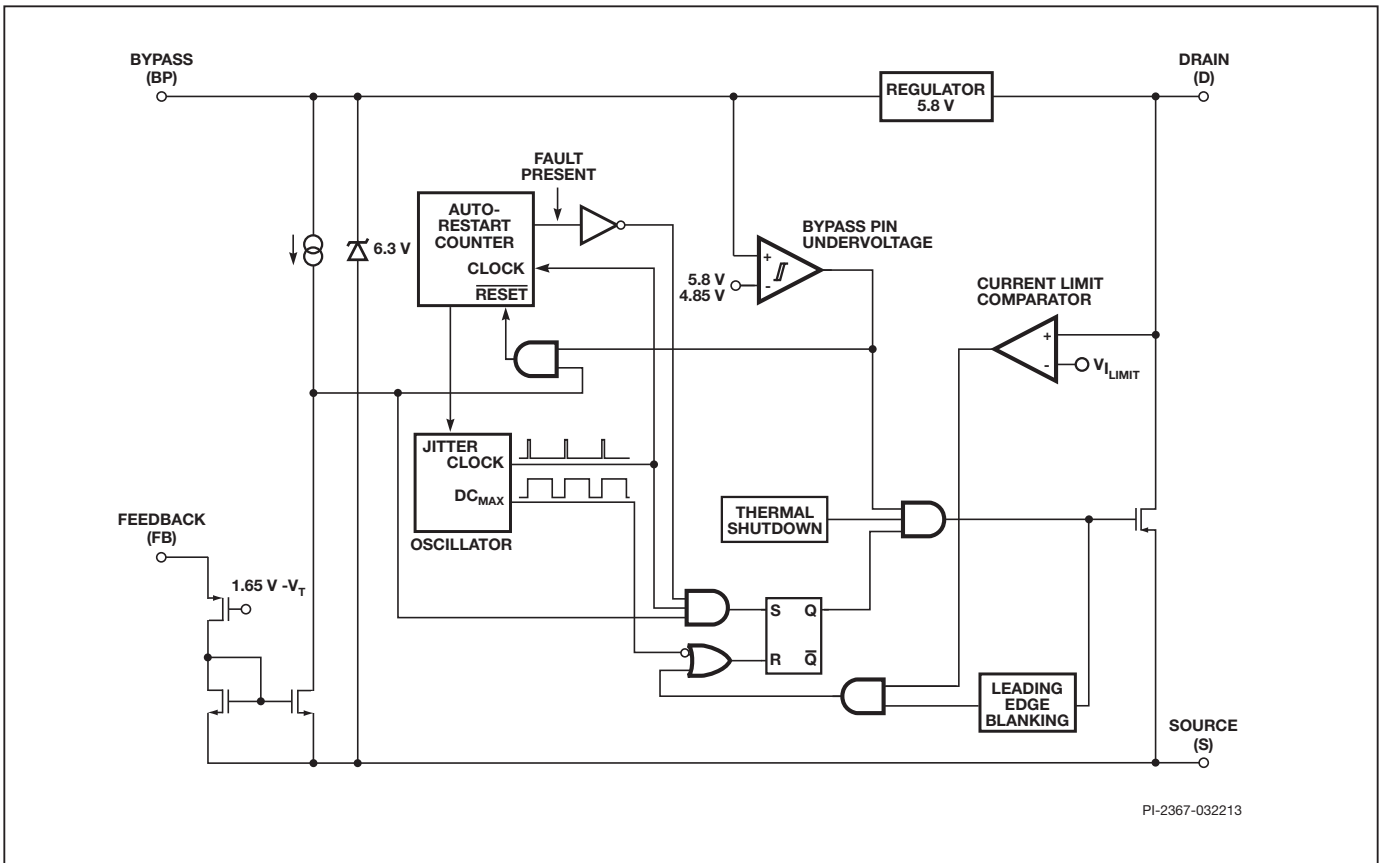

Figure 3b. Functional Block Diagram LYT0004-0006.

## Pin Functional Description

### DRAIN (D) Pin:

Power MOSFET Drain connection. Provides internal operating current for both start-up and steady-state operation.

### BYPASS (BP) Pin:

Connection point for a 0.1  $\mu\text{F}$  external bypass capacitor for the internally generated 5.8 V supply.

### FEEDBACK (FB) Pin:

During normal operation, switching of the power MOSFET is controlled by this pin. Power MOSFET switching is terminated when a current greater than 49  $\mu\text{A}$  is delivered into this pin.

### SOURCE (S) Pin:

This pin is the power MOSFET source connection. It is also the ground reference for the BYPASS and FEEDBACK pins.

and quasi-peak emissions. The frequency jitter should be measured with the oscilloscope triggered at the falling edge of the Drain waveform. The waveform in Figure 5 illustrates the frequency jitter of the LYTSwitch-0.

### Feedback Input Circuit

The feedback input circuit at the FEEDBACK pin consists of a low impedance source follower output set at 1.65 V. When the current delivered into this pin exceeds 49  $\mu\text{A}$ , a low logic level (disable) is generated at the output of the feedback circuit. This output is sampled at the beginning of each cycle on the rising edge of the clock signal. If high, the power MOSFET is turned on for that cycle (enabled), otherwise the power MOSFET remains off (disabled). Since the sampling is done only at the beginning of each cycle, subsequent changes in the FEEDBACK pin voltage or current during the remainder of the cycle are ignored.

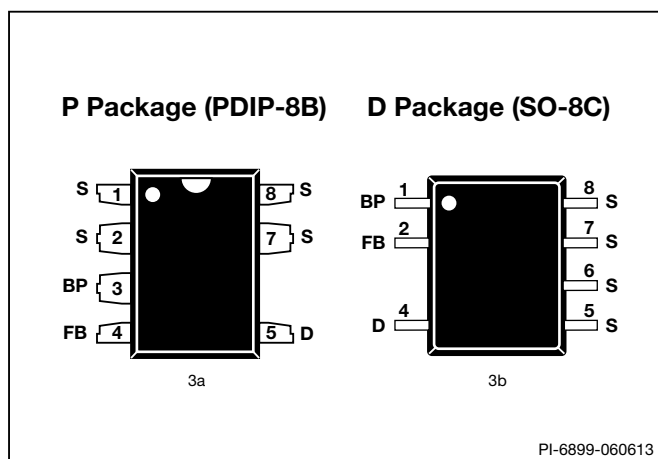

Figure 4. Pin Configuration.

## LYTSwitch-0 Functional Description

LYTSwitch-0 combines a high-voltage power MOSFET switch with a power supply controller in one device. Unlike conventional PWM (pulse width modulator) controllers, LYTSwitch-0 uses a simple ON/OFF control to regulate the output voltage. The LYTSwitch-0 controller consists of an oscillator, feedback (sense and logic) circuit, 5.8 V regulator, BYPASS pin undervoltage circuit, over-temperature protection, frequency jittering, current limit circuit, leading edge blanking and a 700 V power MOSFET. The LYTSwitch-0 incorporates additional circuitry for auto-restart.

### Oscillator

The typical oscillator frequency is internally set to an average of 66 kHz. Two signals are generated from the oscillator: the maximum duty cycle signal ( $\text{DC}_{\text{MAX}}$ ) and the clock signal that indicates the beginning of each cycle.

The LYTSwitch-0 oscillator incorporates circuitry that introduces a small amount of frequency jitter, typically 4 kHz peak-to-peak, to minimize EMI emission. The modulation rate of the frequency jitter is set to 1 kHz to optimize EMI reduction for both average

### 5.8 V Regulator and 6.3 V Shunt Voltage Clamp

The 5.8 V regulator charges the bypass capacitor connected to the BYPASS pin to 5.8 V by drawing a current from the voltage on the DRAIN, whenever the power MOSFET is off. The BYPASS pin is the internal supply voltage node for the LYTSwitch-0. When the power MOSFET is on, the LYTSwitch-0 runs off of the energy stored in the bypass capacitor. Extremely low power consumption of the internal circuitry allows the LYTSwitch-0 to operate continuously from the current drawn from the DRAIN pin. A bypass capacitor value of 0.1  $\mu\text{F}$  is sufficient for both high frequency decoupling and energy storage.

### BYPASS Pin Undervoltage

The BYPASS pin undervoltage circuitry disables the power MOSFET when the BYPASS pin voltage drops below 4.85 V. Once the BYPASS pin voltage drops below 4.85 V, it must rise back to 5.8 V to enable (turn-on) the power MOSFET.

### Over-Temperature Protection

The thermal shutdown circuitry senses the die temperature. The threshold is set at 142  $^{\circ}\text{C}$  typical with a 75  $^{\circ}\text{C}$  hysteresis. When the die temperature rises above this threshold (142  $^{\circ}\text{C}$ ) the power MOSFET is disabled and remains disabled until the die temperature falls by 75  $^{\circ}\text{C}$ , at which point it is re-enabled.

### Current Limit

The current limit circuit senses the current in the power MOSFET. When this current exceeds the internal threshold ( $I_{\text{LIMIT}}$ ), the power MOSFET is turned off for the remainder of that cycle. The leading edge blanking circuit inhibits the current limit comparator for a short time ( $t_{\text{LEB}}$ ) after the power MOSFET is turned on. This leading edge blanking time has been set so that current spikes caused by capacitance and rectifier reverse recovery time will not cause premature termination of the switching pulse cycle.

### Auto-Restart (LYT0004-0006)

In the event of a fault condition such as output overload, output short, or an open loop condition, LYTSwitch-0 enters into auto-restart operation. An internal counter clocked by the oscillator gets reset every time the FEEDBACK pin is pulled

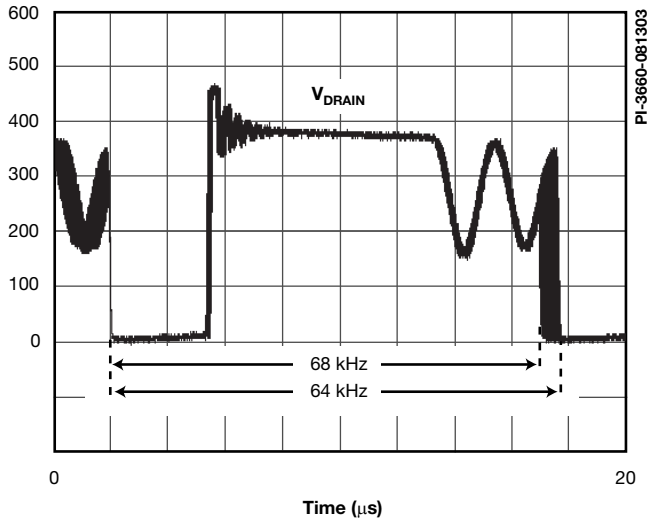

Figure 5. Frequency Jitter.

high. If the FEEDBACK pin is not pulled high for 50 ms, the power MOSFET switching is disabled for 800 ms. The auto-restart alternately enables and disables the switching of the power MOSFET until the fault condition is removed.

### Applications Example

#### A 6 W (Output) Universal Input Buck LED Driver Converter

The circuit shown in Figure 6 is a typical implementation of a non-isolated, power factor corrected buck power supply for LED driver applications. The simplicity and low component count make this ideal for space constrained, cost sensitive designs such as GU10 or A19 size lamps. This design was optimized to drive an LED string at a voltage of 54 V with a constant current of 110 mA, giving 6 W of output power. The design operates over a universal input range from 90 VAC to 265 VAC and achieves an output current tolerance of  $< \pm 5\%$  at nominal line voltage. The input capacitance (C1 + C2) was reduced to achieve the highest possible power factor input

while still meeting conducted EMI limits. Power factor is  $>0.5$  at 230 VAC and  $>0.7$  PF at 120 VAC meeting requirements for LED lamps in Europe and USA.

The input stage comprises fusible resistor RF1, bridge rectifier BR1, capacitors C1 and C2, and inductor L1. Resistor RF1 is a flame proof, fusible, wire wound resistor. It accomplishes several functions: a) Inrush current limitation to below specification of BR1; b) Differential mode conducted EMI noise attenuation; c) Fuse should any other component fail short-circuit; d) Higher power factor. Capacitor C1, C2 and inductor L1 forms a  $\pi$  filter to reduce differential mode EMI. Capacitor C2 provides local decoupling for the switching current through U1. There is an optional parallel resistor on the board across L1 which damps the resonance of the pi filter.

The power processing stage is formed by the integrated MOSFET switch within LYT0006 (U1), a free-wheeling diode (D1), sense resistor (R2), power inductor (L2) and output capacitor (C5). To reduce reverse recovery losses in D1 the value of L2 was designed such that the converter operates in mostly discontinuous conduction mode. Diode D1 is an ultrafast diode with a reverse recovery time ( $t_{RR}$ )  $\approx 35$  ns. This recovery is recommended due to the high ambient operating time temperature which will increase diode reverse recovery charge. A bobbin based EE10 core size inductor was selected for L2 in order to prevent changes in inductance value when placed inside a metal enclosure. Lower cost drum core or dog bone inductor types may also be used, however these have an open magnetic path which can be shorted by a metal enclosure. This reduces the effective inductance and requires the value to be adjusted to take this into account when placed inside the final enclosure.

Capacitor C5 is the output filter capacitor; its primary function is to limit the output current ripple and ensures high frequency currents flow within as small as a loop area as possible to reduce EMI.

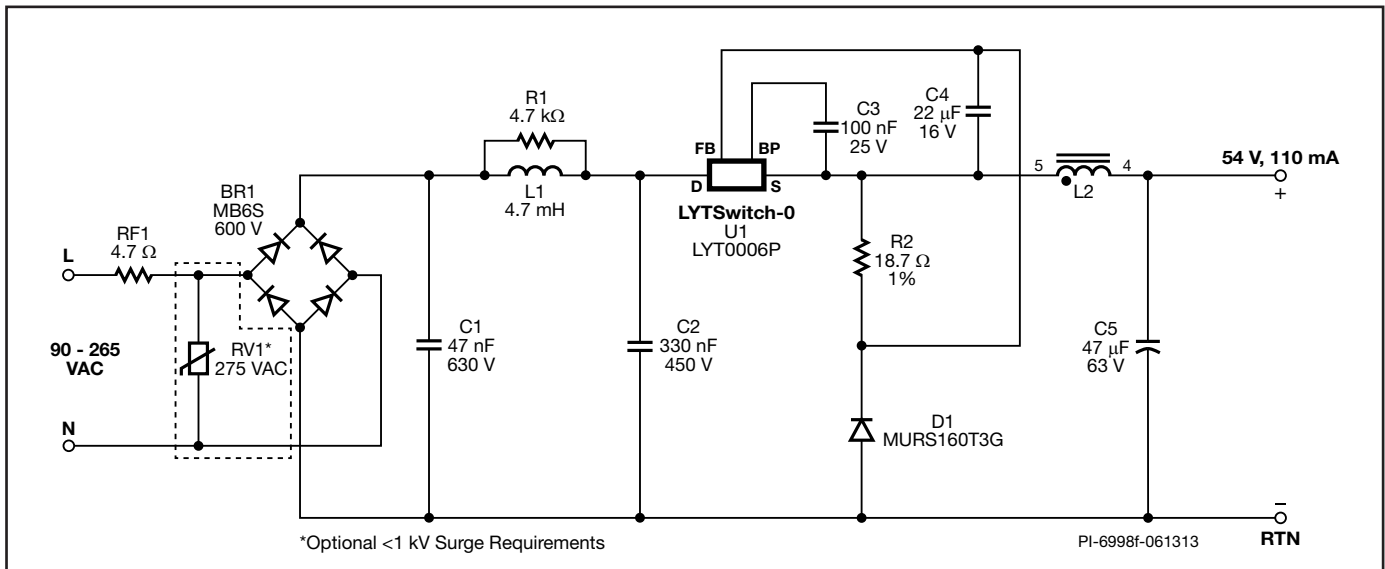

Figure 6. Universal Input, 54 V, 110 mA Constant Current Power Supply using LYTSwitch-0.

The output current is regulated via the voltage across R2 during the free-wheeling period when the internal MOSFET of U1 is off. This voltage is filtered by capacitor (C4) and fed into the FEEDBACK pin of U1. Regulation is maintained by skipping switching cycles. As the output current rises, the voltage on the FEEDBACK pin will rise. If this exceeds  $V_{FB}$  then subsequent cycles will be skipped until the voltage reduces below  $V_{FB}$ .

Open-loop protection is provided via the auto-restart function. If no cycles are skipped during a 50 ms period LYTSwitch-0 will enter auto-restart (LYT0004-0006), limiting the average output power to approximately 6% of the maximum overload power. The auto-restart function requires the value of C3 to be 100 nF or greater such that the IC remains operational from half-line cycle to half-line cycle.

For disconnected LED protection an optional Zener (not shown) can be placed across the output. This will fuse short-circuit and prevent the output voltage rising.

## Key Application Considerations

### LYTSwitch-0 Design Considerations

#### Output Current Table

Data sheet maximum output current table (Table 1) represents the maximum practical continuous output current for both mostly discontinuous conduction mode (MDCM) and continuous conduction mode (CCM) of operation that can be delivered from a given LYTSwitch-0 device under the following assumed conditions:

1. Buck converter topology.
2. The minimum DC input voltage is equal to voltage output.
3. For CCM operation a KRP\* of 0.4.
4. Output voltage of 54 VDC.
5. Efficiency of 90%.
6. A catch/free-wheeling diode with  $t_{RR} \approx 35$  ns is used.
7. The part is board mounted with SOURCE pins soldered to a sufficient area of copper to keep the SOURCE pin temperature at or below 100 °C.

\*KRP is the ratio of ripple to peak inductor current.

### LYTSwitch-0 Selection and Selection Between MDCM and CCM Operation

Select the LYTSwitch-0 device, free-wheeling diode and output inductor that gives the lowest overall cost. In general, MDCM provides the lowest cost and highest efficiency converter. CCM designs require a larger inductor and ultrafast ( $t_{RR} \approx 35$  ns) free-wheeling diode in all cases. It is lower cost to use a larger LYTSwitch-0 in MDCM than a smaller LinkSwitch-0 in CCM because of the additional external component costs of a CCM design. However, if the highest output current is required, CCM should be employed following the guidelines below.

#### Topology Options

LYTSwitch-0 can be used in all common topologies, with or without an optocoupler and reference to improve output voltage tolerance and regulation. Table 2 provide a summary of these configurations.

## Component Selection

Referring to Figure 6, the following considerations may be helpful in selecting components for a LYTSwitch-0 design.

### Optional Varistor (RV1)

The Metal Oxide Varistor (RV1) is used to suppress the line surge in order to meet IEC61000-4-5 (differential input line 1.2/50  $\mu$ s and differential ring wave input line surge). A MOV is recommended for high PF designs with surge levels of 1 kV or greater. High PF design requires lower input capacitance values giving a greater voltage rise across limited input capacitance during surge events. A MOV is typically not required if the design will use high-input capacitance ( $\mu$ F's vs. nF's) (non-PF application).

### Input Capacitance C1 and C2

Use a film capacitor if the input capacitance is less than 1  $\mu$ F. Make sure that the RMS current rating is not exceeded especially if planning to use electrolytic capacitor. For universal or high-line only input design use 400 V or 630 V rated capacitors, and for low-line only use 250 V rated capacitors for lower cost and smaller size.

### Free-wheeling Diode D1

Diode D1 should be an ultrafast type. For MDCM, reverse recovery time of  $\leq 75$  ns should be used in designs where the diode temperature is 70 °C or below. Slower diodes are not acceptable, as continuous mode operation will always occur during start-up, causing high leading edge current spikes, terminating the switching cycle prematurely, and preventing the output from reaching regulation. If the diode temperature is above 70 °C then a diode with a reverse recovery time of  $\leq 35$  ns should be used.

For CCM an ultrafast diode with reverse recovery time  $\leq 35$  ns should be used. Slower diodes cause excessive leading edge current spikes, terminating the switching cycle prematurely and preventing full power delivery.

Standard plastic or fast ( $t_{RR} > 75$  ns) diodes should never be used as the large reverse recovery currents can cause excessive power dissipation in the diode and/or exceed the maximum drain current specification of LYTSwitch-0.

### Inductor L1

Choose any standard off-the-shelf inductor that meets the design requirements. A "drum" or "dog bone" "I" core inductor is recommended with a single ferrite element due to its low-cost and very low audible noise properties. The typical inductance value and RMS current rating can be obtained from the LYTSwitch-0 PIXIs design spreadsheet. The PIXIs application is part of the PI Expert design suite available for free download from Power Integrations. Choose L1 greater than or equal to the typical calculated inductance.

Note that the open magnetic path of non-shielded discrete inductors may cause inductance value changes when placed within metal enclosure requiring a larger value to be used.

### Output Capacitor C5

The primary function of capacitor C5 is to smooth the inductor current. Select a low or ultra-low ESR series if electrolytic types are used to ensure capacitor heating is minimized. Ceramic or solid polymer types are also suitable but are typically higher cost per unit capacitance.

Select the voltage rating to be the nearest above the LED string voltage. Select the initial capacitance value based on the ripple current parameter calculated in the design spreadsheet. The capacitance value may be further increased to reduce the LED ripple current dependent on the specification requirements of the driver. For long life use 105 °C or above rated parts unless the ambient temperature inside the lamp is less than 80 °C and select a series with an appropriate lifetime rating. Note that operating electrolytic capacitors below their rated temperature specification will significantly extend their lifetime e.g., 105 °C capacitor operated at 80 °C will increase lifetime by a factor of 2 to 3.

### Sense Resistor R2

Sense resistor should be a 1% tolerance and either pulse rated or oversized to avoid resistance drift with time. If using a standard metal film type, oversize power rating by 2-4 times. The value of the resistor is provided in the design spreadsheet.

### Feedback Capacitor C4

Capacitor C4 can be a low-cost general purpose capacitor. It provides a “sample and hold” function, charging to the sensed current value during the off-time of LYTSwitch-0. Its value should be 10  $\mu$ F to 22  $\mu$ F; smaller values cause poorer regulation and lower efficiency. This capacitor also bypasses the switching current during the free-wheeling period, reducing the sense resistor dissipation.

### LYTSwitch-0 Layout Considerations

In the buck or buck-boost converter configuration, since the SOURCE pins in LYTSwitch-0 are switching nodes, the copper area connected to SOURCE should be minimized to minimize EMI within the thermal constraints of the design.

In the boost and non-isolated flyback configuration, since the SOURCE pins are tied to DC return, the copper area connected to SOURCE can be maximized to improve heat sinking.

The loop formed between the LYTSwitch-0, inductor (L2), free-wheeling diode (D1), and output capacitor (C5) should be kept as small as possible. The BYPASS pin capacitor C3 (Figure 7a) should be located physically close to the SOURCE (S) and BYPASS (BP) pins. To minimize direct coupling from

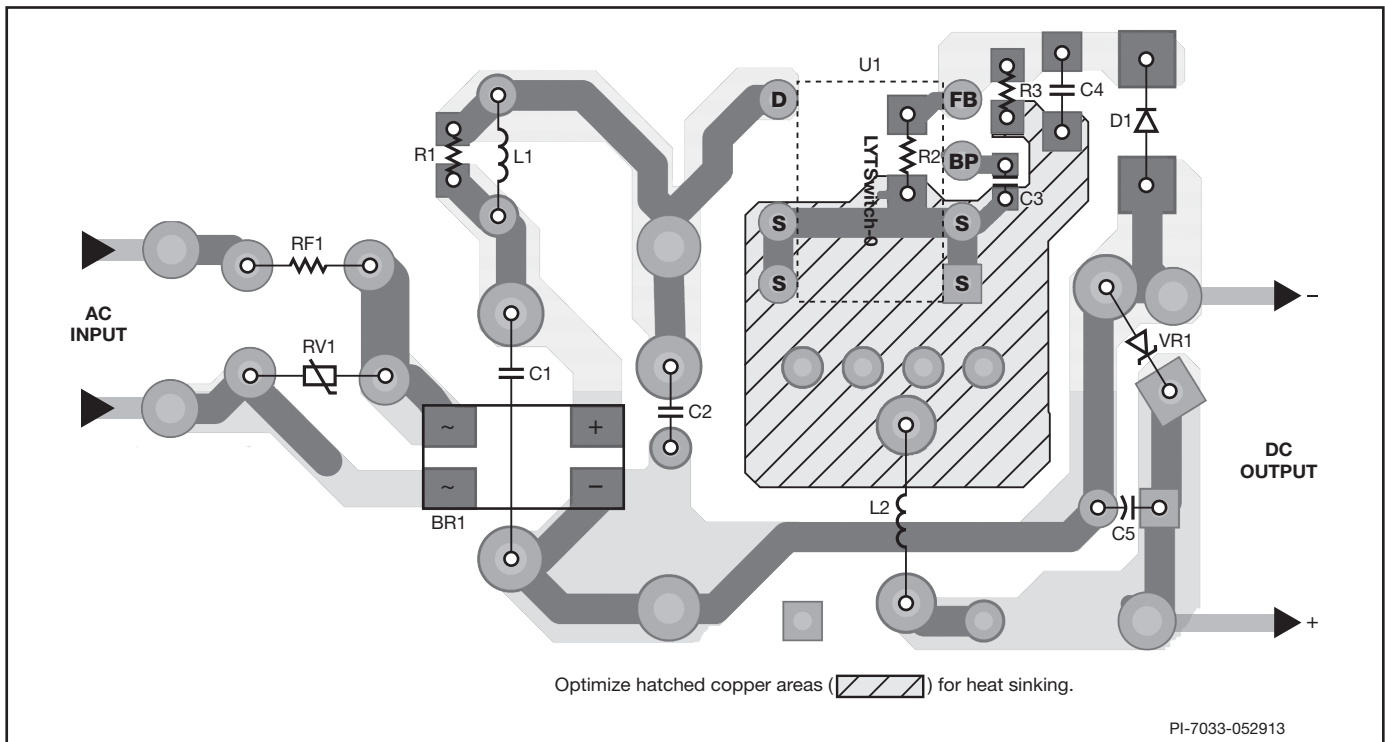

Figure 7a. Recommended Printed Circuit Layout for LYTSwitch-0 in a Buck Converter Configuration using P Package.

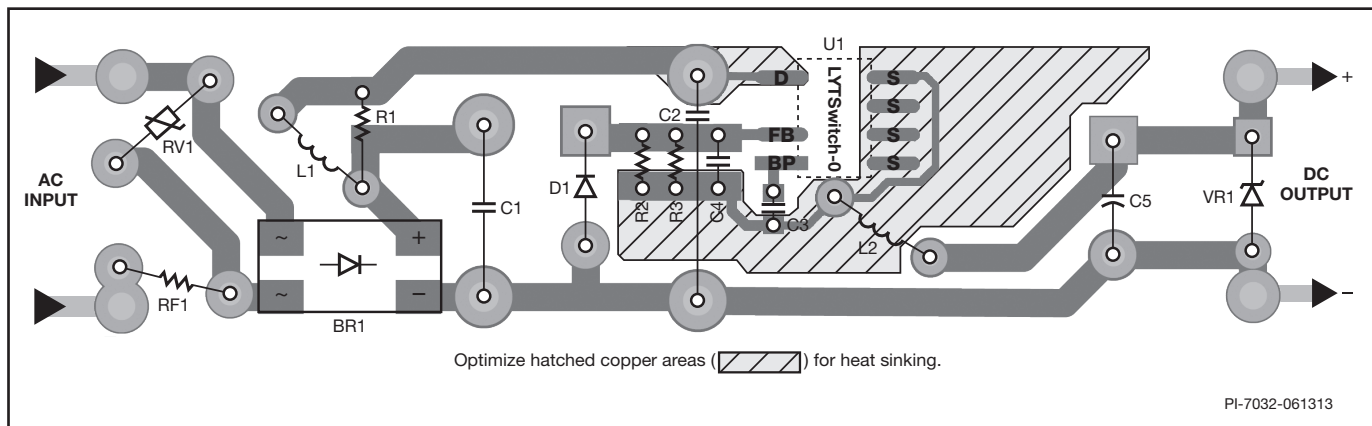

Figure 7b. Recommended Printed Circuit Layout for LYTSwitch-0 in a Buck Converter Configuration using D Package to Bottom Side of the Board.

switching nodes, the LYTSwitch-0 should be placed away from AC input lines. It may be advantageous to place capacitors C1 and C2 in-between LYTSwitch-0 and the AC input.

### Quick Design Checklist

As with any power supply design, all LYTSwitch-0 designs should be verified for proper functionality on the bench. The following minimum tests are recommended:

1. Correct diode selection – UF400x series diodes are recommended only for designs that operate in MDCM at an ambient of 70 °C or below. For designs operating in continuous conduction mode (CCM) and/or higher ambient, then a diode with a reverse recovery time of 35 ns or better, such as the BYV26C, is recommended.
2. Maximum drain current – Verify that the peak drain current is below the data sheet peak drain specification under worst-case conditions of highest line voltage, maximum overload (just prior to auto-restart) and highest ambient temperature.
3. Thermal check – At maximum output power, minimum input voltage and maximum ambient temperature, verify that the LYTSwitch-0 SOURCE pin temperature is 110 °C or below. This figure ensures adequate margin due to variations in

$R_{DS(ON)}$  from part to part. A battery powered thermocouple meter is recommended to make measurements when the SOURCE pins are a switching node. Alternatively, the ambient temperature may be raised to indicate margin to thermal shutdown.

4. Check for any presence of reverse current in the DRAIN pin during start-up with the output capacitance fully discharged. Presence of reverse current is possible for CCM (high-power inductance >3 mH) at certain conditions for limited input capacitance ( $V_{OUT} = V_{BULK\_MIN}$  every input half-line AC cycle). Using a current probe, check if negative current is measured either by increase input capacitance, reduce inductance or place an ultrafast diode in series with the Drain node.
5. Follow the design procedure in AN-60 for the optimum line regulation.
6. Power factor can be optimized by adjusting the conduction time of the bridge rectifier. Refer to AN-60 for more details.

In a LYTSwitch-0 design using a buck or buck-boost converter topology, the SOURCE pin is a switching node. Oscilloscope measurements should therefore be made with probe grounded to a DC voltage, such as primary return or DC input rail, and not to the SOURCE pins. The power supply input must always be supplied from an isolated source (e.g. via an isolation transformer).

**Absolute Maximum Ratings<sup>(1,5)</sup>**

DRAIN Pin Voltage.....	-0.3 V to 700 V
Peak DRAIN Pin Current (LYT0002) .....	200 mA (375 mA) <sup>(2)</sup>
Peak DRAIN Pin Current (LYT0004) .....	400 mA (750 mA) <sup>(2)</sup>
Peak DRAIN Pin Current (LYT0005) .....	800 mA (1500 mA) <sup>(2)</sup>
Peak DRAIN Pin Current (LYT0006) .....	1400 mA (2600 mA) <sup>(2)</sup>
FEEDBACK Pin Voltage .....	-0.3 V to 9 V
FEEDBACK Pin Current .....	100 mA
BYPASS Pin Voltage .....	-0.3 V to 9 V
Storage Temperature .....	-65 °C to 150 °C
Operating Junction Temperature <sup>(3)</sup> .....	-40 °C to 150 °C
Lead Temperature <sup>(4)</sup> .....	260 °C

Notes:

1. All voltages referenced to SOURCE, T<sub>A</sub> = 25 °C.
2. The higher peak DRAIN current is allowed if the DRAIN to SOURCE voltage does not exceed 400 V.
3. Normally limited by internal circuitry.
4. 1/16 in. from case for 5 seconds.
5. Maximum ratings specified may be applied, one at a time, without causing permanent damage to the product. Exposure to Absolute Maximum Rating conditions for extended periods of time may affect product reliability.

**Thermal Resistance**

Thermal Resistance: P Package:

(θ <sub>JA</sub> ) .....	70 °C/W <sup>(3)</sup> ; 60 °C/W <sup>(4)</sup>
(θ <sub>JC</sub> ) <sup>(1)</sup> .....	11 °C/W

D Package:

(θ <sub>JA</sub> ) .....	100 °C/W <sup>(3)</sup> ; 80 °C/W <sup>(4)</sup>
(θ <sub>JC</sub> ) <sup>(2)</sup> .....	30 °C/W

Notes:

1. Measured on pin 2 (SOURCE) close to plastic interface.
2. Measured on pin 8 (SOURCE) close to plastic interface.
3. Soldered to 0.36 sq. in. (232 mm<sup>2</sup>), 2 oz. (610 g/m<sup>2</sup>) copper clad.
4. Soldered to 1 sq. in. (645 mm<sup>2</sup>), 2 oz. (610 g/m<sup>2</sup>) copper clad.

Parameter	Symbol	Conditions		Min	Typ	Max	Units
		SOURCE = 0 V; T <sub>J</sub> = -40 to 125 °C See Figure 8 (Unless Otherwise Specified)					
<b>Control Functions</b>							
Output Frequency	f <sub>OSC</sub>	T <sub>J</sub> = 25 °C	Average	62	66	70	kHz
			Peak-Peak Jitter		4		
Maximum Duty Cycle	DC <sub>MAX</sub>	S2 Open		66	69	72	%
FEEDBACK Pin Turnoff Threshold Current	I <sub>FB</sub>	T <sub>J</sub> = 25 °C		30	49	68	μA
FEEDBACK Pin Voltage at Turnoff Threshold	V <sub>FB</sub>			1.54	1.65	1.76	V
DRAIN Pin Supply Current	I <sub>S1</sub>	V <sub>FB</sub> ≥ 2 V (MOSFET Not Switching) See Note A			130	220	μA
	I <sub>S2</sub>	FEEDBACK Open (MOSFET Switching) See Notes A, B	LYT0002		165	260	μA
			LYT0004		173	280	
			LYT0005		190	310	
			LYT0006		226	330	

Parameter	Symbol	Conditions		Min	Typ	Max	Units
		SOURCE = 0 V; $T_J = -40$ to $125$ °C See Figure 8 (Unless Otherwise Specified)					
<b>Control Functions (cont.)</b>							
<b>BYPASS Pin Charge Current</b>	$I_{CH1}$	$V_{BP} = 0$ V $T_J = 25$ °C See Note C	LYT0002/0004	-5.5	-3.35	-1.8	mA
			LYT0005-0006	-7.5	-4.6	-2.5	
	$I_{CH2}$	$V_{BP} = 4$ V $T_J = 25$ °C See Note C	LYT0002/0004	-3.8	-2.3	-1.0	
			LYT0005-0006	-4.5	-3.3	-1.5	
<b>BYPASS Pin Voltage</b>	$V_{BP}$		5.55	5.8	6.10	V	
<b>BYPASS Pin Voltage Hysteresis</b>	$V_{BPH}$		0.8	0.95	1.2	V	
<b>BYPASS Pin Supply Current</b>	$I_{BPSC}$	See Note D	68			$\mu$ A	
<b>Circuit Protection</b>							
<b>Current Limit</b>	$I_{LIMIT}$ (See Note E)	$di/dt = 55$ mA/ $\mu$ s $T_J = 25$ °C	LYT0002	126	136	146	mA
		$di/dt = 250$ mA/ $\mu$ s $T_J = 25$ °C		145	165	185	
		$di/dt = 65$ mA/ $\mu$ s $T_J = 25$ °C	LYT0004	195	210	225	
		$di/dt = 415$ mA/ $\mu$ s $T_J = 25$ °C		222	265	282	
		$di/dt = 75$ mA/ $\mu$ s $T_J = 25$ °C	LYT0005	240	257	275	
		$di/dt = 500$ mA/ $\mu$ s $T_J = 25$ °C		271	310	345	
		$di/dt = 95$ mA/ $\mu$ s $T_J = 25$ °C	LYT0006	350	375	401	
		$di/dt = 610$ mA/ $\mu$ s $T_J = 25$ °C		396	450	504	
<b>Minimum On Time</b>	$t_{ON(MIN)}$		LYT0002/0004	280	360	475	ns
			LYT0005	360	460	610	
			LYT0006	400	500	675	
<b>Leading Edge Blanking Time</b>	$t_{LEB}$	$T_J = 25$ °C See Note F	170	215		ns	
<b>Thermal Shutdown Temperature</b>	$T_{SD}$		135	142	150	°C	
<b>Thermal Shutdown Hysteresis</b>	$T_{SHD}$	See Note G		75		°C	

Parameter	Symbol	Conditions		Min	Typ	Max	Units
		SOURCE = 0 V; $T_J = -40$ to $125$ °C See Figure 8 (Unless Otherwise Specified)					
<b>Output</b>							
<b>ON-State Resistance</b>	$R_{DS(ON)}$	LYT0002 $I_D = 13$ mA	$T_J = 25$ °C		42	55.2	$\Omega$
			$T_J = 100$ °C		67	88.4	
		LYT0004 $I_D = 25$ mA	$T_J = 25$ °C		21	27.6	
			$T_J = 100$ °C		40	44.2	
		LYT0005 $I_D = 35$ mA	$T_J = 25$ °C		11	13.8	
			$T_J = 100$ °C		19	22.1	
LYT0006 $I_D = 45$ mA	$T_J = 25$ °C		6	8.1			
	$T_J = 100$ °C		11	12.9			
<b>OFF-State Drain Leakage Current</b>	$I_{DSS}$	$V_{BP} = 6.2$ V, $V_{FB} \geq 2$ V, $V_{DS} = 560$ V, $T_J = 25$ °C	LYT0002			50	$\mu$ A
			LYT0004			60	
			LYT0005			75	
			LYT0006			90	
<b>Breakdown Voltage</b>	$BV_{DSS}$	$V_{BP} = 6.2$ V, $V_{FB} \geq 2$ V, $T_J = 25$ °C		700			V
<b>Rise Time</b>	$t_R$	Measured in a Typical Buck Converter Application			50		ns
<b>Fall Time</b>	$t_F$				50		ns
<b>DRAIN Supply Voltage</b>				50			V
<b>Output Enable Delay</b>	$t_{EN}$	See Figure 10				10	$\mu$ s
<b>Output Disable Setup Time</b>	$t_{DST}$				0.5		$\mu$ s
<b>Auto-Restart ON-Time</b>	$t_{AR}$	$T_J = 25$ °C See Note H	LYT0002	Not Applicable			ms
			LYT0004-0006		50		
<b>Auto-Restart Duty Cycle</b>	$DC_{AR}$		LYT0002	Not Applicable			%
			LYT0004-0006		6		

## NOTES:

- Total current consumption is the sum of  $I_{S1}$  and  $I_{DSS}$  when FEEDBACK pin voltage is  $\geq 2$  V (MOSFET not switching) and the sum of  $I_{S2}$  and  $I_{DSS}$  when FEEDBACK pin is shorted to SOURCE (MOSFET switching).
- Since the output power MOSFET is switching, it is difficult to isolate the switching current from the supply current at the DRAIN. An alternative is to measure the BYPASS pin current at 6 V.
- See Typical Performance Characteristics section Figure 15 for BYPASS pin start-up charging waveform.
- This current is only intended to supply an optional optocoupler connected between the BYPASS and FEEDBACK pins and not any other external circuitry.
- For current limit at other di/dt values, refer to Figure 14.
- This parameter is guaranteed by design.
- This parameter is derived from characterization.
- Auto-restart on time has the same temperature characteristics as the oscillator (inversely proportional to frequency).

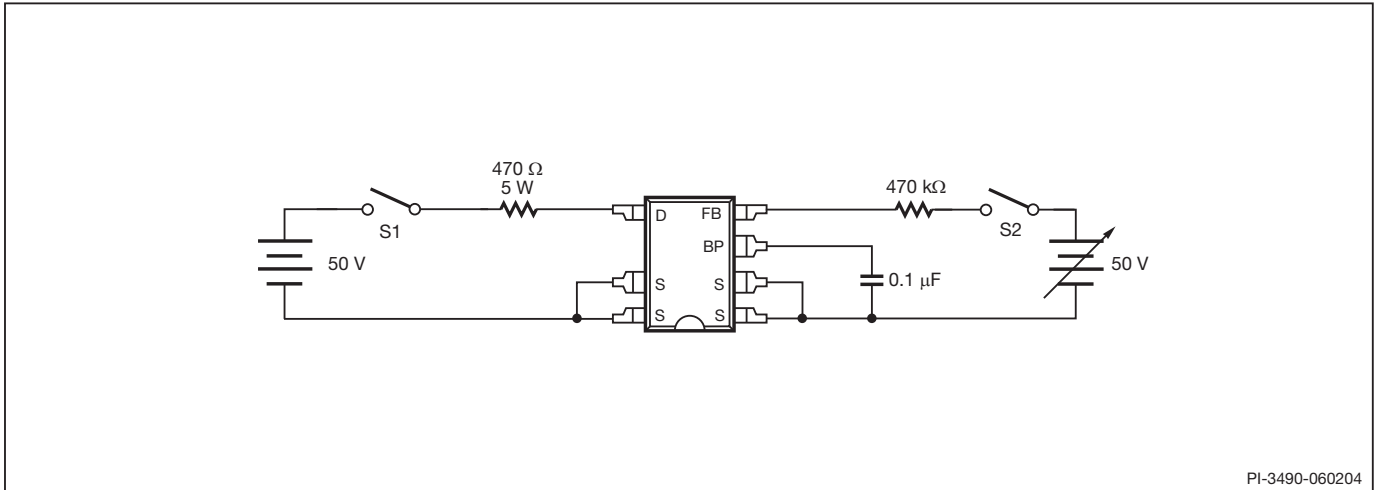

PI-3490-060204

Figure 8. LYTSwitch-0 General Test Circuit.

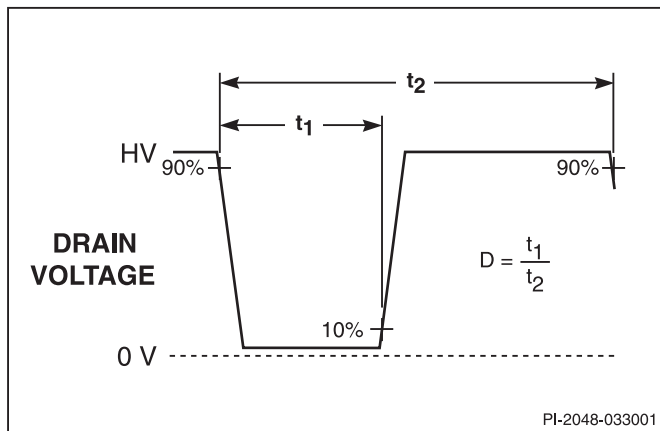

PI-2048-033001

Figure 9. LYTSwitch-0 Duty Cycle Measurement.

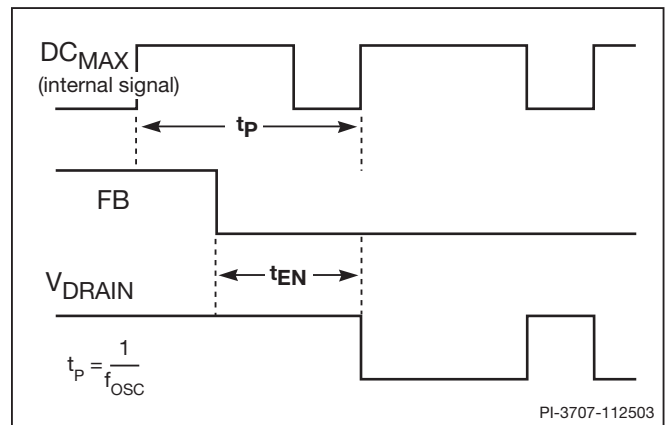

PI-3707-112503

Figure 10. LYTSwitch-0 Output Enable Timing.

Typical Performance Characteristics

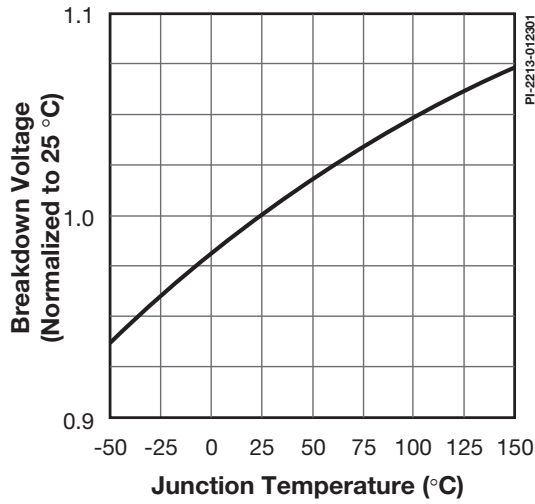

Figure 11. Breakdown vs. Temperature.

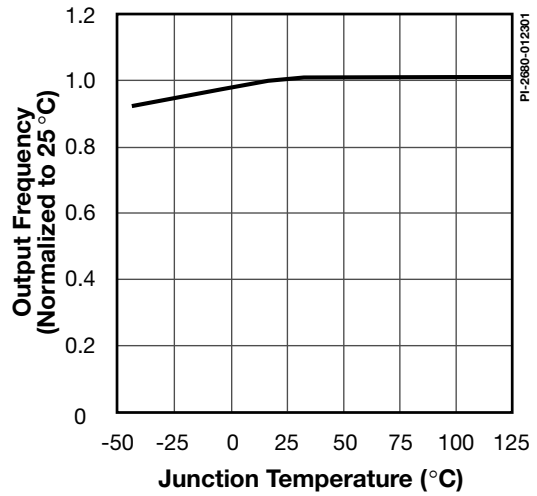

Figure 12. Frequency vs. Temperature.

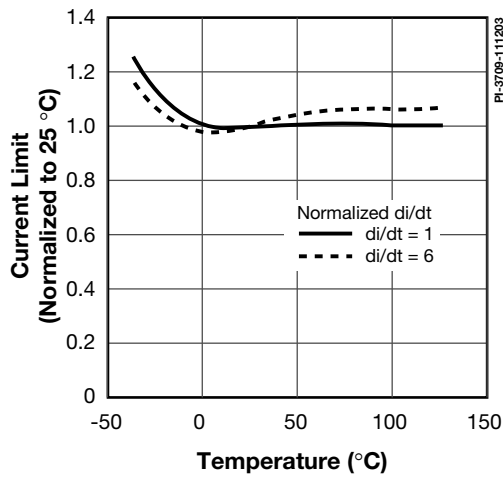

Figure 13. Current Limit vs. Temperature at Normalized di/dt.

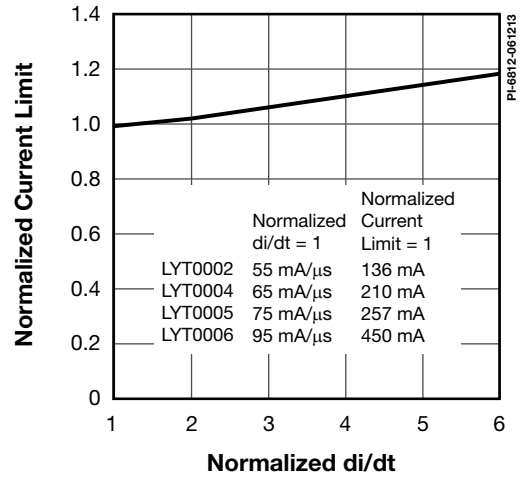

Figure 14. Current Limit vs. di/dt.

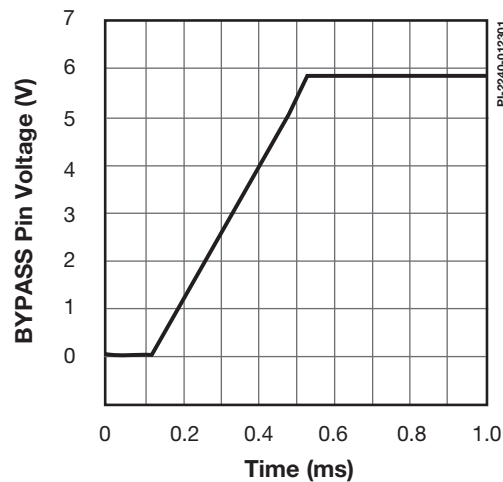

Figure 15. BYPASS Pin Start-up Waveform.

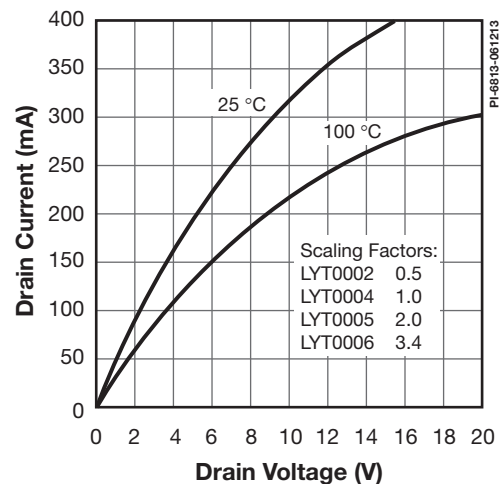

Figure 16. Output Characteristics.

Typical Performance Characteristics (cont.)

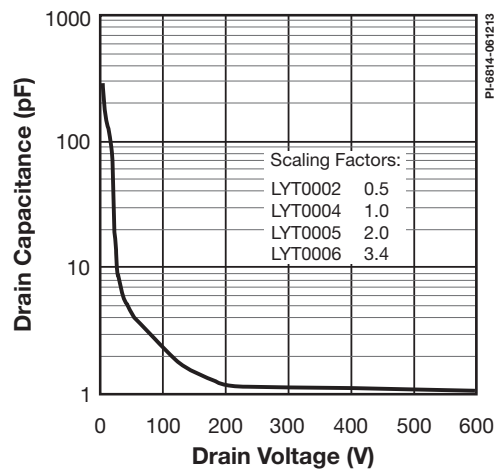
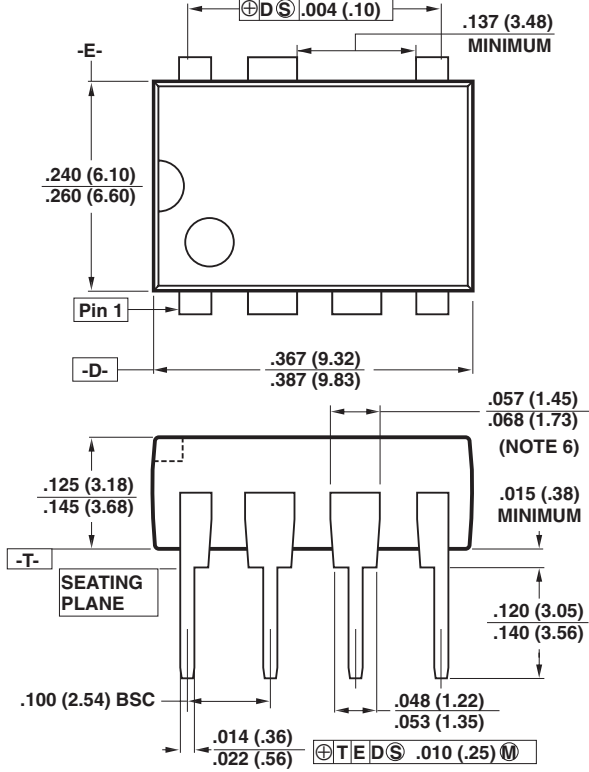

Figure 17.  $C_{OSS}$  vs. Drain Voltage.

**PDIP-8B (P Package)**



**Notes:**

1. Package dimensions conform to JEDEC specification MS-001-AB (Issue B 7/85) for standard dual-in-line (DIP) package with .300 inch row spacing.
2. Controlling dimensions are inches. Millimeter sizes are shown in parentheses.
3. Dimensions shown do not include mold flash or other protrusions. Mold flash or protrusions shall not exceed .006 (.15) on any side.
4. Pin locations start with Pin 1, and continue counter-clockwise to Pin 8 when viewed from the top. The notch and/or dimple are aids in locating Pin 1. Pin 6 is omitted.
5. Minimum metal to metal spacing at the package body for the omitted lead location is .137 inch (3.48 mm).
6. Lead width measured at package body.
7. Lead spacing measured with the leads constrained to be perpendicular to plane T.

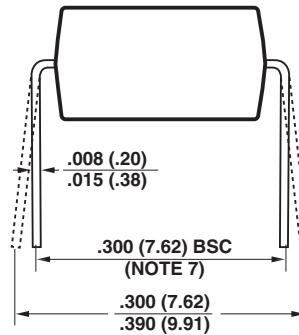

**P08B**

PI-2551-040110



---

Notes

Revision	Notes	Date
A	Initial Release	06/13
B	Updated with new Brand Style Logo.	06/15

### For the latest updates, visit our website: [www.power.com](http://www.power.com)

Power Integrations reserves the right to make changes to its products at any time to improve reliability or manufacturability. Power Integrations does not assume any liability arising from the use of any device or circuit described herein. POWER INTEGRATIONS MAKES NO WARRANTY HEREIN AND SPECIFICALLY DISCLAIMS ALL WARRANTIES INCLUDING, WITHOUT LIMITATION, THE IMPLIED WARRANTIES OF MERCHANTABILITY, FITNESS FOR A PARTICULAR PURPOSE, AND NON-INFRINGEMENT OF THIRD PARTY RIGHTS.

### Patent Information

The products and applications illustrated herein (including transformer construction and circuits external to the products) may be covered by one or more U.S. and foreign patents, or potentially by pending U.S. and foreign patent applications assigned to Power Integrations. A complete list of Power Integrations patents may be found at [www.power.com](http://www.power.com). Power Integrations grants its customers a license under certain patent rights as set forth at <http://www.power.com/ip.htm>.

### Life Support Policy

POWER INTEGRATIONS PRODUCTS ARE NOT AUTHORIZED FOR USE AS CRITICAL COMPONENTS IN LIFE SUPPORT DEVICES OR SYSTEMS WITHOUT THE EXPRESS WRITTEN APPROVAL OF THE PRESIDENT OF POWER INTEGRATIONS. As used herein:

1. A Life support device or system is one which, (i) is intended for surgical implant into the body, or (ii) supports or sustains life, and (iii) whose failure to perform, when properly used in accordance with instructions for use, can be reasonably expected to result in significant injury or death to the user.
2. A critical component is any component of a life support device or system whose failure to perform can be reasonably expected to cause the failure of the life support device or system, or to affect its safety or effectiveness.

The PI logo, TOPSwitch, TinySwitch, LinkSwitch, LYTSwitch, InnoSwitch, DPA-Switch, PeakSwitch, CAPZero, SENZero, LinkZero, HiperPFS, HiperTFS, HiperLCS, Qspeed, EcoSmart, Clampless, E-Shield, Filterfuse, FluxLink, StakFET, PI Expert and PI FACTS are trademarks of Power Integrations, Inc. Other trademarks are property of their respective companies. ©2015, Power Integrations, Inc.

### Power Integrations Worldwide Sales Support Locations

**World Headquarters**  
5245 Hellyer Avenue  
San Jose, CA 95138, USA.  
Main: +1-408-414-9200  
Customer Service:  
Phone: +1-408-414-9665  
Fax: +1-408-414-9765  
e-mail: [usasales@power.com](mailto:usasales@power.com)

**China (Shanghai)**  
Rm 1601/1610, Tower 1,  
Kerry Everbright City  
No. 218 Tianmu Road West,  
Shanghai, P.R.C. 200070  
Phone: +86-21-6354-6323  
Fax: +86-21-6354-6325  
e-mail: [chinasales@power.com](mailto:chinasales@power.com)

**China (Shenzhen)**  
17/F, Hivac Building, No. 2,  
Keji Nan 8th Road, Nanshan  
District, Shenzhen, China,  
518057  
Phone: +86-755-8672-8689  
Fax: +86-755-8672-8690  
e-mail: [chinasales@power.com](mailto:chinasales@power.com)

**Germany**  
Lindwurmstrasse 114  
80337 Munich  
Germany  
Phone: +49-895-527-39110  
Fax: +49-895-527-39200  
e-mail: [eurosales@power.com](mailto:eurosales@power.com)

**India**  
#1, 14th Main Road  
Vasanthanagar  
Bangalore-560052 India  
Phone: +91-80-4113-8020  
Fax: +91-80-4113-8023  
e-mail: [indiasales@power.com](mailto:indiasales@power.com)

**Italy**  
Via Milanese 20, 3rd. Fl.  
20099 Sesto San Giovanni (MI)  
Italy  
Phone: +39-024-550-8701  
Fax: +39-028-928-6009  
e-mail: [eurosales@power.com](mailto:eurosales@power.com)

**Japan**  
Kosei Dai-3 Bldg.  
2-12-11, Shin-Yokohama,  
Kohoku-ku  
Yokohama-shi Kanagwan  
222-0033 Japan  
Phone: +81-45-471-1021  
Fax: +81-45-471-3717  
e-mail: [japansales@power.com](mailto:japansales@power.com)

**Korea**  
RM 602, 6FL  
Korea City Air Terminal B/D, 159-6  
Samsung-Dong, Kangnam-Gu,  
Seoul, 135-728, Korea  
Phone: +82-2-2016-6610  
Fax: +82-2-2016-6630  
e-mail: [koreasales@power.com](mailto:koreasales@power.com)

**Singapore**  
51 Newton Road  
#19-01/05 Goldhill Plaza  
Singapore, 308900  
Phone: +65-6358-2160  
Fax: +65-6358-2015  
e-mail: [singaporesales@power.com](mailto:singaporesales@power.com)

**Taiwan**  
5F, No. 318, Nei Hu Rd., Sec. 1  
Nei Hu Dist.  
Taipei 11493, Taiwan R.O.C.  
Phone: +886-2-2659-4570  
Fax: +886-2-2659-4550  
e-mail: [taiwansales@power.com](mailto:taiwansales@power.com)

**UK**  
First Floor, Unit 15, Meadway  
Court, Rutherford Close,  
Stevenage, Herts. SG1 2EF  
United Kingdom  
Phone: +44 (0) 1252-730-141  
Fax: +44 (0) 1252-727-689  
e-mail: [eurosales@power.com](mailto:eurosales@power.com)

## Looking for pricing, stock, or lifecycle information?

Click below to explore more details on WIN SOURCE:

 [View LYT0002P on WIN SOURCE](#)

 [Power Integrations](#) Information

## Optimize Your Supply Chain with WIN SOURCE Solutions

-  Global Sourcing Solution
-  Obsolete Management
-  Cost Control Management
-  Shortage Management
-  Alternative Solution
-  Excess Inventory Management