



THE DATASHEET OF LTV-354T-C



FEATURES



- * Current transfer ratio
(CTR : MIN. 20% at $I_F = \pm 1\text{mA}$, $V_{CE} = 5\text{V}$)
- * Isolation voltage between input and output LTV-354T
($V_{iso} = 3,750\text{V}_{rms}$)
- * Mini-flat package :
2.0mm profile : LTV-354T
- * UL, CUL, CSA, FIMKO, NEMKO, DEMKO, SEMKO approved
- * RoHS compliance

APPLICATIONS

- * Hybrid substrates that require high density mounting.
- * Programmable controllers
- * System appliance, measuring instruments

OUTLINE DIMENSIONS

LTV-354T :

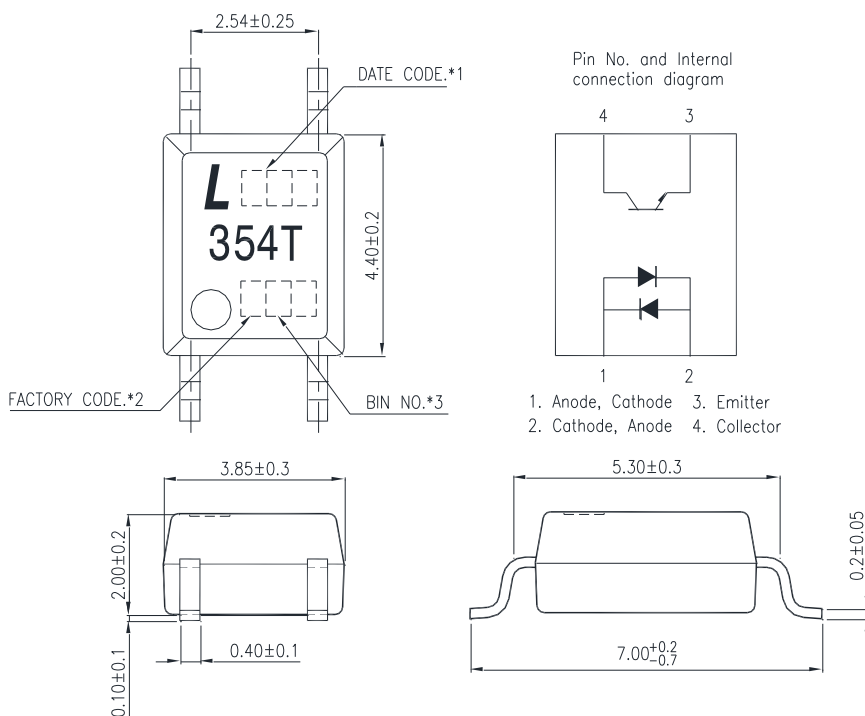

- *1. 3-digit date code.
- *2. Factory identification mark shall be marked (W: China-CJ, X: China-TJ, Y: Thailand).
- *3. Rank shall be or shall not be marked.

TAPING DIMENSIONS

TP1 MINI FLAT (3000pcs/reel) : Suffix "-TP1"

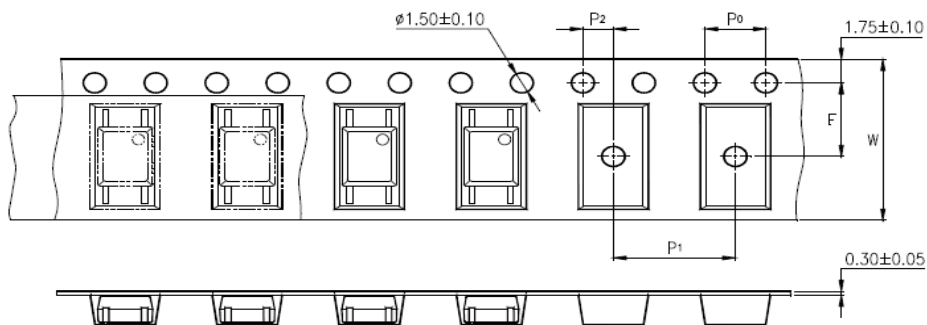

TP MINI FLAT (3000pcs/reel) : Suffix "-TP"

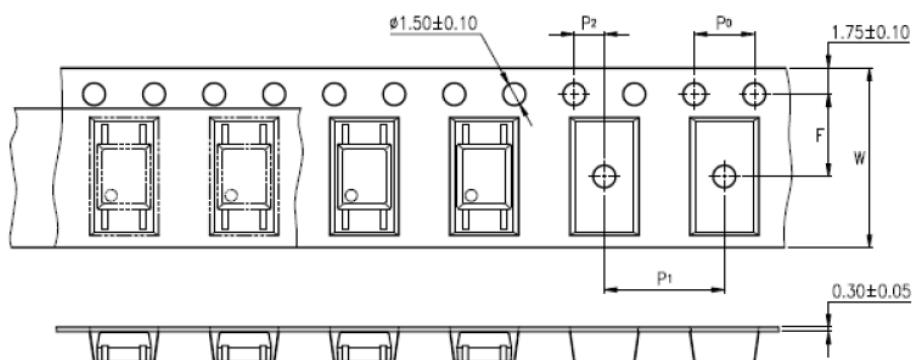

Content Quantity

Model	Reel volume (pcs/Reel)	Inner Box volume (Reel/Box)	Outer carton volume (Box/Carton)	Total volume (pcs/outer carton)
MFP TP/TP1	3000	2	10	60000

Description	Symbol	Dimensions in mm (inches)
Tape wide	W	12 ± 0.3 (.47)
Pitch of sprocket holes	P_0	4 ± 0.1 (.15)
Distance of compartment	F	5.5 ± 0.1 (.217)
Distance of compartment to compartment	P_2	2 ± 0.1 (.079)
Distance of compartment to compartment	P_1	8 ± 0.1 (.315)

ABSOLUTE MAXIMUM RATING

(Ta = 25°C)

PARAMETER		SYMBOL	RATING	UNIT
INPUT	Forward Current	I _F	±50	mA
	Power Dissipation	P	70	mW
OUTPUT	Collector - Emitter Voltage	V _{CEO}	35	V
	Emitter - Collector Voltage	V _{ECO}	6	V
	Collector Current	I _c	50	mA
	Collector Power Dissipation	P _c	150	mW
Total Power Dissipation		P _{tot}	170	mW
*1	Isolation Voltage	V _{iso}	3,750	V _{rms}
Operating Temperature		T _{opr}	-30~ +110	°C
Storage Temperature		T _{stg}	-55 ~ +150	°C
*2	Soldering Temperature	T _{sol}	260	°C

*1. AC For 1 Minute, R.H. = 40 ~ 60%

Isolation voltage shall be measured using the following method.

- (1) Short between anode and cathode on the primary side and between collector and emitter on the secondary side.
- (2) The isolation voltage tester with zero-cross circuit shall be used.
- (3) The waveform of applied voltage shall be a sine wave.

*2. For 10 Seconds

ELECTRICAL - OPTICAL CHARACTERISTICS

(Ta = 25°C)

PARAMETER		SYMBOL	MIN.	TYP.	MAX.	UNIT	CONDITIONS
INPUT	Forward Voltage	V _F	—	1.2	1.4	V	I _F =±20mA
	Terminal Capacitance	C _t	—	30	250	pF	V=0, f=1KHz
OUTPUT	Collector Dark Current	I _{CEO}	—	—	100	nA	V _{CE} =20V, I _F =0
	Collector-Emitter Breakdown Voltage	BV _{CEO}	35	—	—	V	I _C =0.1mA I _F =0
	Emitter-Collector Breakdown Voltage	BV _{ECO}	6	—	—	V	I _E =10μA I _F =0
TRANSFER CHARACTERISTICS	Collector Current	I _C	0.2	—	4	mA	I _F =±1mA V _{CE} =5V
	*1 Current Transfer Ratio	CTR	20	—	400	%	
	Collector-Emitter Saturation Voltage	V _{CE(sat)}	—	0.1	0.2	V	I _F =±20mA I _C =1mA
	Isolation Resistance	R _{iso}	5×10 ¹⁰	1×10 ¹¹	—	Ω	DC500V 40 ~ 60% R.H.
	Floating Capacitance	C _f	—	0.6	1	pF	V=0, f=1MHz
	Response Time (Rise)	t _r	—	4	18	μs	V _{CE} =2V, I _C =2mA R _L =100Ω
	Response Time (Fall)	t _f	—	3	18	μs	

$$*1 \text{ CTR} = \frac{I_C}{I_F} \times 100\%$$

RANK TABLE OF CURRENT TRANSFER RATIO CTR

MODEL NO.	RANK MARK	CTR (%)
LTV-354T	A	50 ~ 150
	A or No mark	20 ~ 400

CONDITIONS	$I_F = \pm 1 \text{ mA}$ $V_{CE} = 5 \text{ V}$ $T_a = 25 \text{ }^\circ\text{C}$
-------------------	-----------------------------------------------------------------------------------------

CHARACTERISTICS CURVES

Fig.1 Forward Current vs. Ambient Temperature

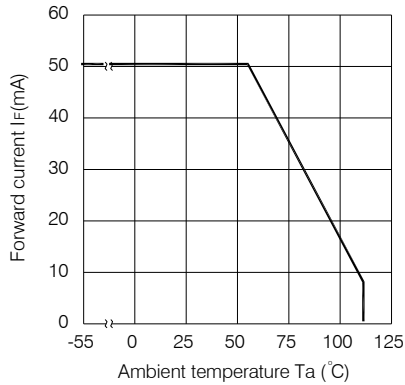

Fig.2 Collector Power Dissipation vs. Ambient Temperature

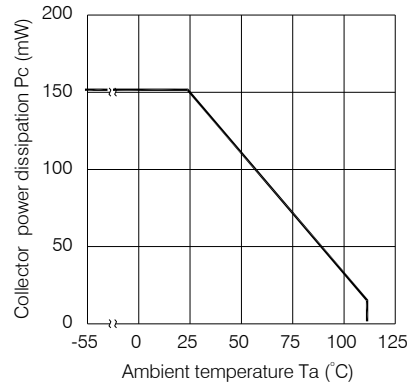

Fig.3 Collector-emitter Saturation Voltage vs. Forward Current

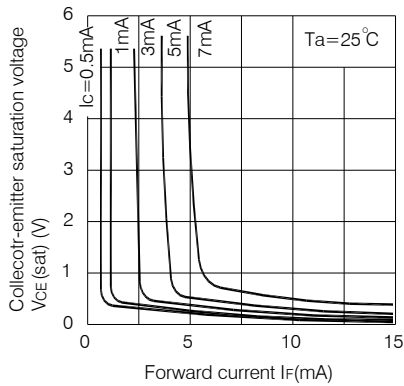

Fig.4 Forward Current vs. Forward Voltage

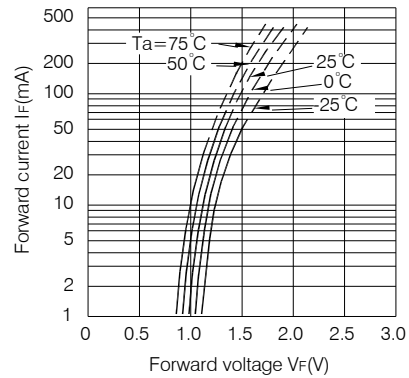

Fig.5 Current Transfer Ratio vs. Forward Current

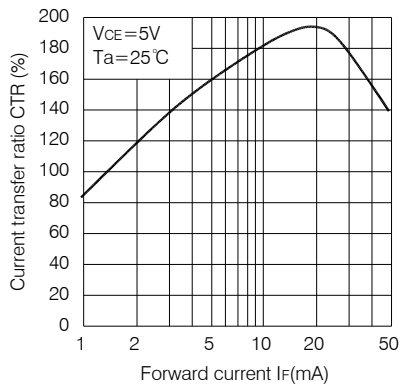
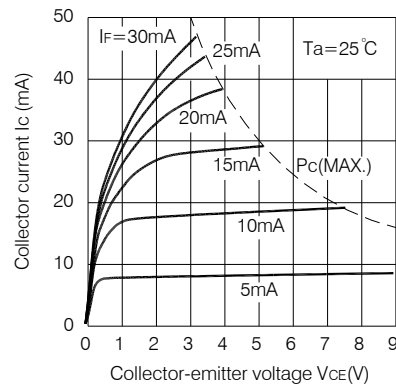

Fig.6 Collector Current vs. Collector-emitter Voltage



CHARACTERISTICS CURVES

Fig.7 Relative Current Transfer Ratio vs. Ambient Temperature

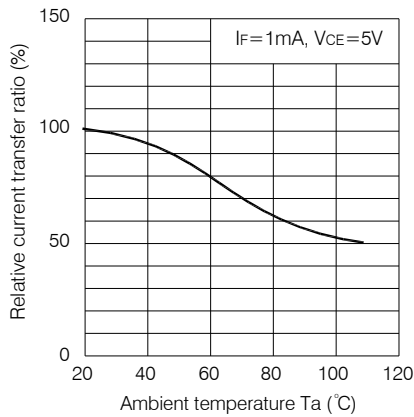

Fig.8 Collector-emitter Saturation Voltage vs. Ambient Temperature

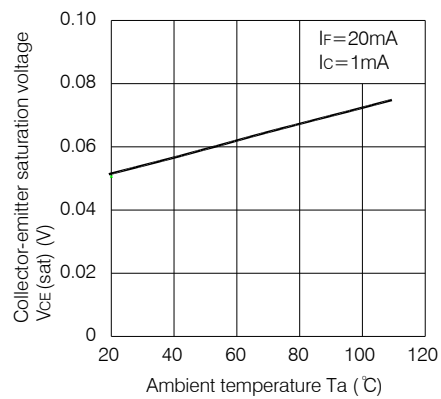

Fig.9 Collector Dark Current vs. Ambient Temperature

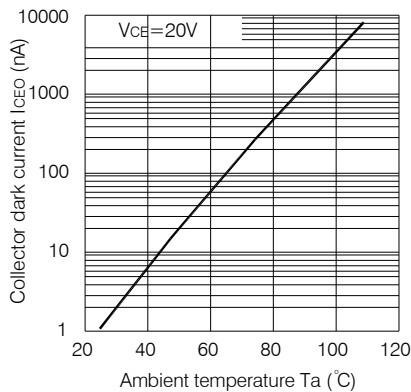

Fig.10 Response Time vs. Load Resistance

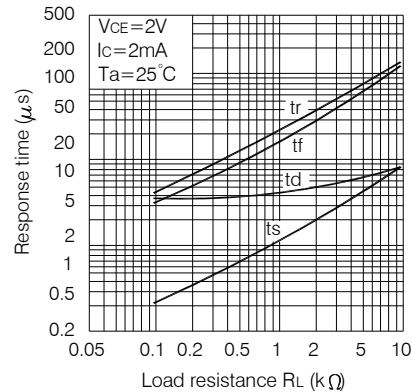
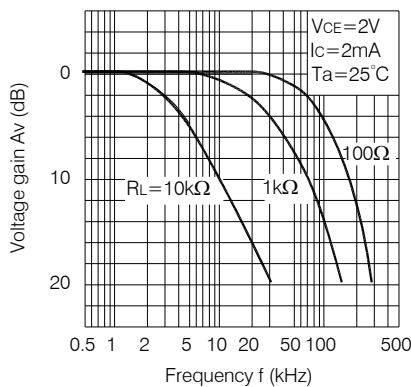
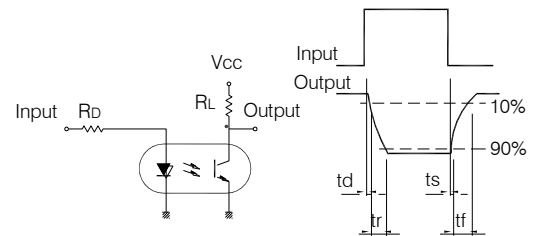

Fig.11 Frequency Response



Test Circuit for Response Time



Test Circuit for Frequency Response

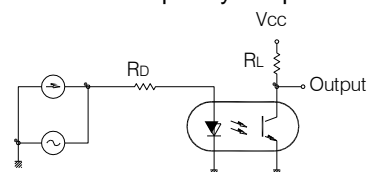

TEMPERATURE PROFILE OF SOLDERING REFLOW

(1) IR Reflow soldering (JEDEC-STD-020C compliant)

One time soldering reflow is recommended within the condition of temperature and time profile shown below.

Profile item	Conditions
Preheat - Temperature Min (T_{Smin}) - Temperature Max (T_{Smax}) - Time (min to max) (ts)	150°C 200°C 90±30 sec
Soldering zone - Temperature (T_L) - Time (t_L)	217°C 60 sec
Peak Temperature (T_P)	260°C
Ramp-up rate	3°C / sec max.
Ramp-down rate	3~6°C / sec

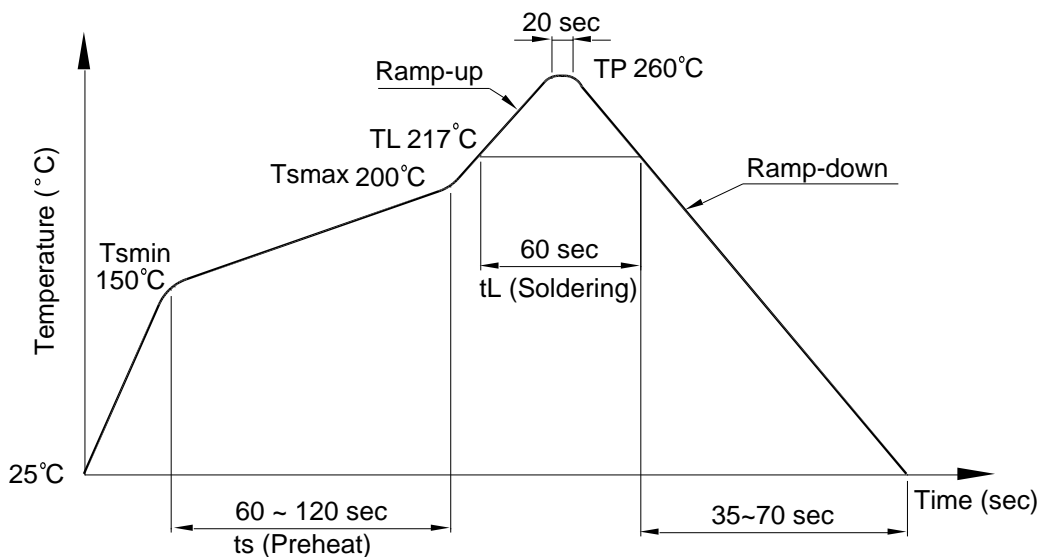

TEMPERATURE PROFILE OF SOLDERING REFLOW

(2) Wave soldering (JEDEC22A111 compliant)

One time soldering is recommended within the condition of temperature.

Temperature: $260 \pm 0/-5^{\circ}\text{C}$

Time: 10 sec.

Preheat temperature: 25 to 140°C

Preheat time: 30 to 80 sec.

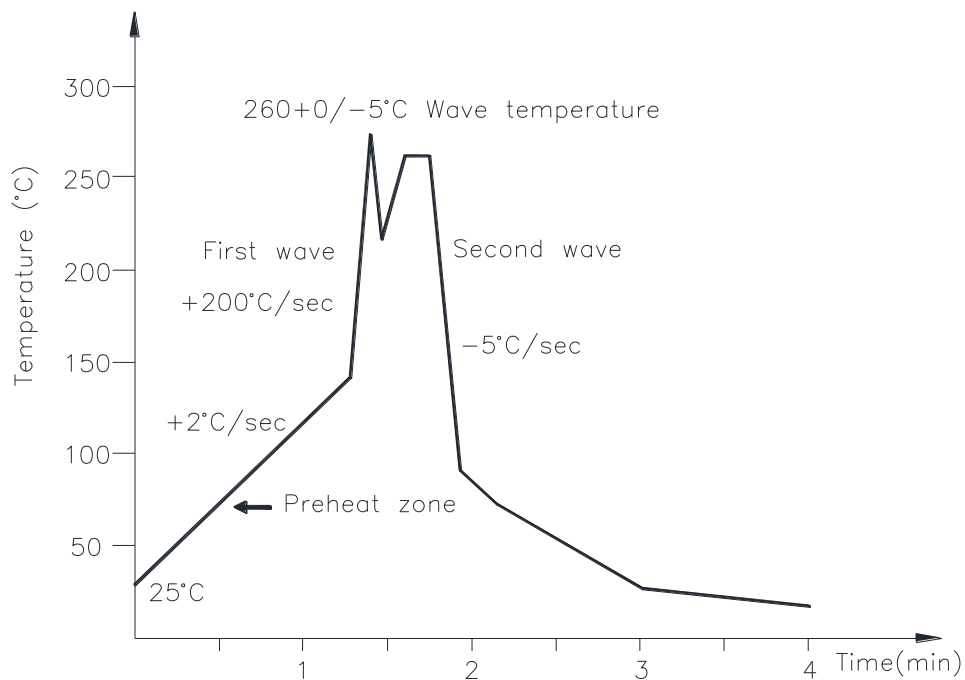

(3) Hand soldering by soldering iron

Allow single lead soldering in every single process. One time soldering is recommended.

Temperature: $380 \pm 0/-5^{\circ}\text{C}$

Time: 3 sec max.

RECOMMENDED FOOT PRINT PATTERNS (MOUNT PAD)

Unit : mm

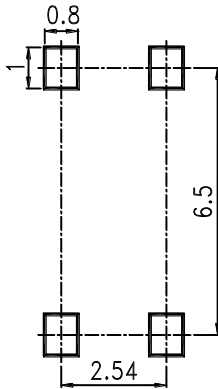

TEMPERATURE PROFILE OF SOLDERING REFLOW

- Lite-On is continually improving the quality, reliability, function or design and Lite-On reserves the right to make changes without further notices.
- The products shown in this publication are designed for the general use in electronic applications such as office automation equipment, communications devices, audio/visual equipment, electrical application and instrumentation.
- For equipment/devices where high reliability or safety is required, such as space applications, nuclear power control equipment, medical equipment, etc, please contact our sales representatives.
- When requiring a device for any "specific" application, please contact our sales in advice.
- If there are any questions about the contents of this publication, please contact us at your convenience.
- The contents described herein are subject to change without prior notice.
- Immerge unit's body in solder paste is not recommended.







Looking for pricing, stock, or lifecycle information?

Click below to explore more details on WIN SOURCE:

 [View LTV-354T-C on WIN SOURCE](#)

 [Lite-On Inc. Information](#)

Optimize Your Supply Chain with WIN SOURCE Solutions

-  Global Sourcing Solution
-  Obsolete Management
-  Cost Control Management
-  Shortage Management
-  Alternative Solution
-  Excess Inventory Management