



IR Emitter and Detector Product Data Sheet

LTR-306

Spec No.: DS-50-92-0116

Effective Date: 05/03/2000

Revision: B

LITE-ON DCC

RELEASE

BNS-OD-FC001/A4

FEATURES

- * WIDE RANGE OF COLLECTOR CURRENT
- * THE LENS IS FOR HIGH SENSITIVITY
- * LOW COST PLASTIC SIDE LOOKING PACKAGE

PACKAGE DIMENSIONS

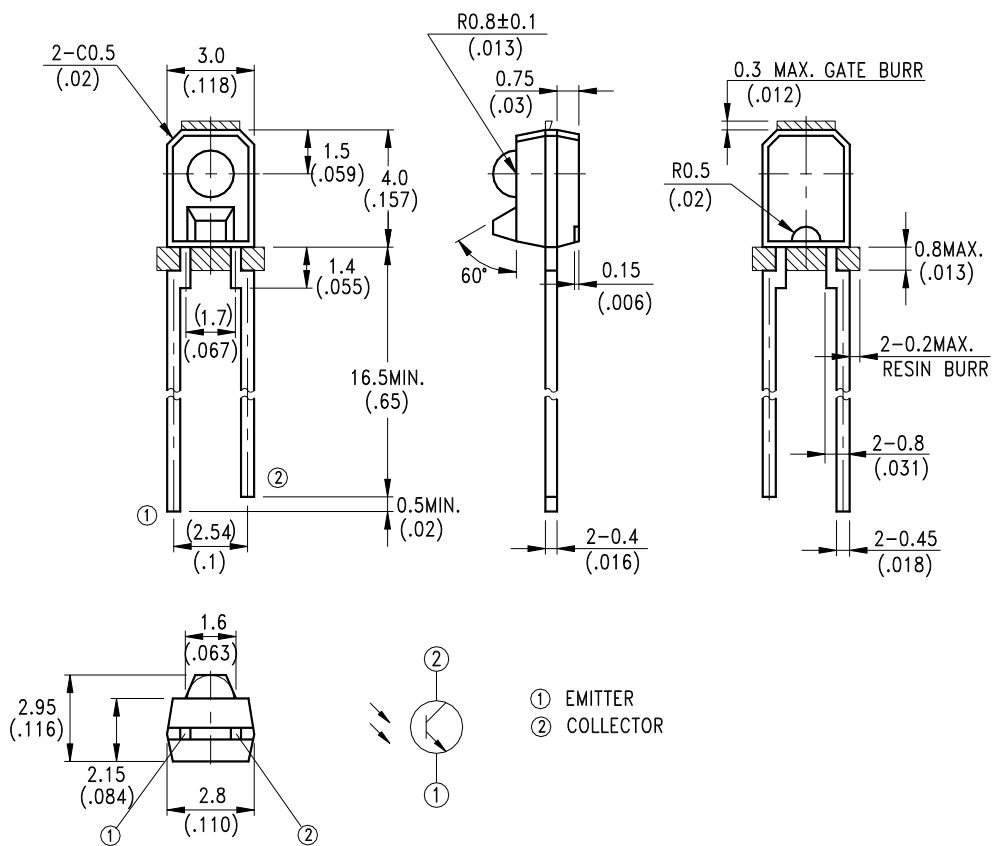

NOTES:

1. All dimensions are in millimeters (inches).
2. Tolerance is $\pm 0.25\text{mm}(.010\text{'})$ unless otherwise noted.
3. Lead spacing is measured where the leads emerge from the package.
4. Specifications are subject to change without notice.



ABSOLUTE MAXIMUM RATINGS AT TA=25°C

PARAMETER	MAXIMUM RATING	UNIT
Power Dissipation	100	mW
Collector-Emitter Voltage	30	V
Emitter-Collector Voltage	5	V
Operating Temperature Range	-40°C to + 85°C	
Storage Temperature Range	-55°C to + 100°C	
Lead Soldering Temperature [1.6mm(.063") From Body]	260°C for 5 Seconds	

ELECTRICAL OPTICAL CHARACTERISTICS AT TA=25°C

PARAMETER	SYMBOL	MIN.	TYP.	MAX.	UNIT	TEST CONDITION	BIN NO.
Collector-Emitter Breakdown Voltage	$V_{(BR)CEO}$	30			V	$I_C = 1mA$ $E_e = 0mW/cm^2$	
Emitter-Collector Breakdown Voltage	$V_{(BR)ECO}$	5			V	$I_E = 100 \mu A$ $E_e = 0mW/cm^2$	
Collector Emitter Saturation Voltage	$V_{CE(SAT)}$		0.1	0.4	V	$I_C = 100 \mu A$ $E_e = 1mW/cm^2$	
Rise Time	T_r		20		μs	$V_{CC} = 5V$ $I_C = 1mA$ $R_L = 1K\Omega$	
Fall Time	T_f		20		μs		
Collector Dark Current	I_{CEO}		0.1	100	nA	$V_{CE} = 10V$ $E_e = 0mW/cm^2$	
On State Collector Current	$I_{C(ON)}$	0.20		0.60	mA	$V_{CE} = 5V$ $E_e = 1mW/cm^2$ $\lambda = 940nm$	BIN A
		0.40		1.08			BIN B
		0.72		1.56			BIN C
		1.04		1.80			BIN D
		1.20		2.40			BIN E
		1.60					BIN F

TYPICAL ELECTRICAL / OPTICAL CHARACTERISTICS CURVES

(25°C Ambient Temperature Unless Otherwise Noted)

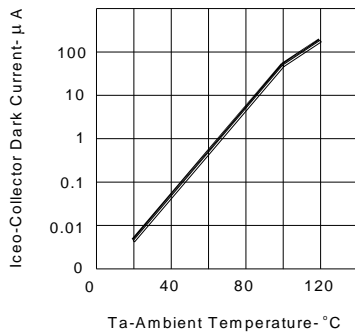

FIG.1 COLLECTOR DARK CURRENT VS AMBIENT TEMPERATURE

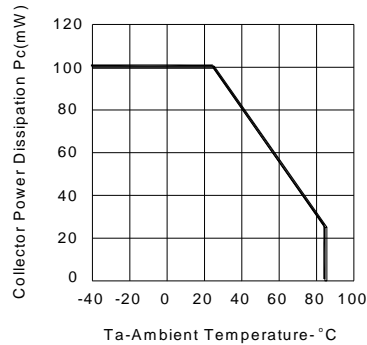

FIG.2 COLLECTOR POWER DISSIPATION VS AMBIENT TEMPERATURE

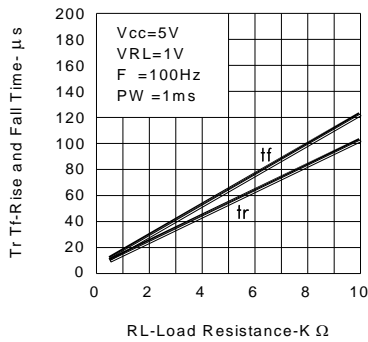

FIG.3 RISE AND FALL TIME VS LOAD RESISTANCE

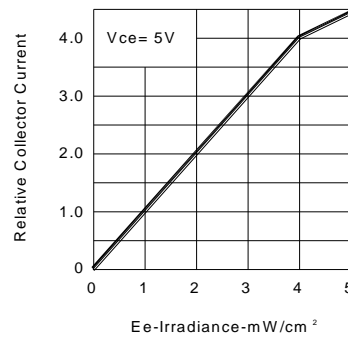

FIG.4 RELATIVE COLLECTOR CURRENT VS IRRADIANCE

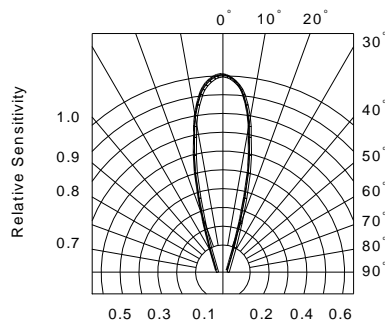









FIG.5 SENSITIVITY DIAGRAM

Looking for pricing, stock, or lifecycle information?

Click below to explore more details on WIN SOURCE:

-  [View LTR-306 on WIN SOURCE](#)
-  [Lite-On Inc. Information](#)

Optimize Your Supply Chain with WIN SOURCE Solutions

-  Global Sourcing Solution
-  Obsolete Management
-  Cost Control Management
-  Shortage Management
-  Alternative Solution
-  Excess Inventory Management