



**THE DATASHEET OF
LTM8042IV#PBF**



FEATURES

- True Color PWM™ with 3000:1 Dimming Ratio
- Operates in Boost, Buck Mode or Buck-Boost Mode
- Wide Input Voltage Range:
 Operation from 3V to 30V
 Transient Protection to 40V
- Gate Driver for Optional PWM Dimming with P-channel MOSFET
- Adjustable Frequency: 250kHz to 2MHz
- Constant-Current and Constant-Voltage Regulation
- Low Shutdown Current: <1µA
- RoHS Compliant Package with Gold Pad Finish
- Tiny, Low Profile (9mm × 15mm × 2.82mm)
 Surface Mount LGA Package

APPLICATIONS

- Display Backlighting
- Automotive and Avionic Lighting
- Illumination
- Scanners

LT, LT, LTC, LTM, Linear Technology, the Linear logo and µModule are registered trademarks and True Color PWM is a trademark of Linear Technology Corporation. All other trademarks are the property of their respective owners.

DESCRIPTION

The LTM[®]8042 is a complete µModule[®] Boost LED Driver specifically designed to drive LEDs up to 1A, while the LTM8042-1 drives up to 350mA. It combines a boost power topology with a unique current loop to operate as a constant-current source. The PWM input provides as much as 3000:1 LED dimming, while 10:1 analog dimming can be accomplished by a single resistor or analog voltage applied to the CTL pin. As with any boost topology, the LTM8042/LTM8042-1 has an uninterrupted current path between its input and output and is thus intolerant to a short-circuit or overload from the output to ground.

| # WHITE LEDs | LED CURRENT | 12V _{IN} | 24V _{IN} |
|--------------|-------------|-------------------|-------------------|
| 6 | 1A | LTM8042 | |
| 7 | 350mA | LTM8042-1 | |
| 8 | 1A | | LTM8042 |
| 9 | 350mA | | LTM8042-1 |

The LTM8042/LTM8042-1 is packaged in a thermally enhanced, compact overmolded land grid array (LGA) package. The LTM8042/LTM8042-1 is Pb-free and a RoHS compliant.

TYPICAL APPLICATION

µModule Boost LED Driver, Driving 8 White LEDs at 1A

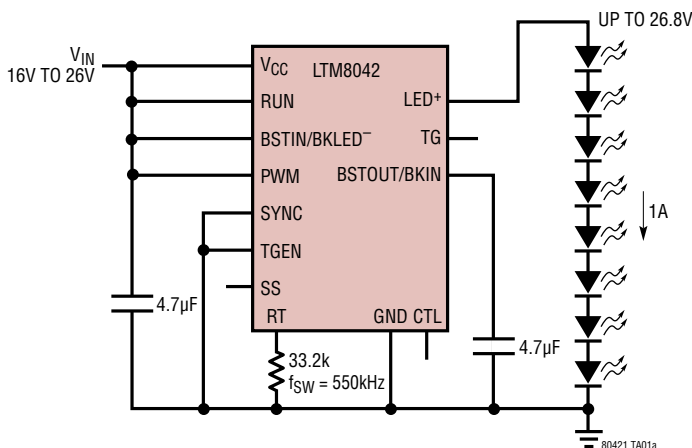

Efficiency vs V_{IN}

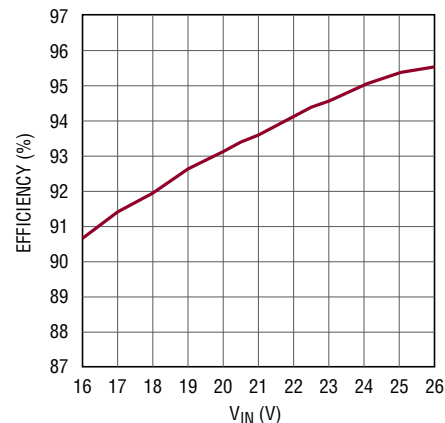

LTM8042/LTM8042-1

ABSOLUTE MAXIMUM RATINGS

(Note 1)

| | |
|---|----------------|
| V_{CC} , RUN, PWM, TGEN, BSTIN/BKLED ⁻ | 40V |
| BSTOUT/BKIN, LED ⁺ | 43V |
| CTL, SYNC | 6V |
| Internal Operating Temperature (Notes 3, 4) | -40°C to 125°C |
| Maximum Reflow Body Temperature | 245°C |
| Storage Temperature | -55°C to 125°C |

PIN CONFIGURATION

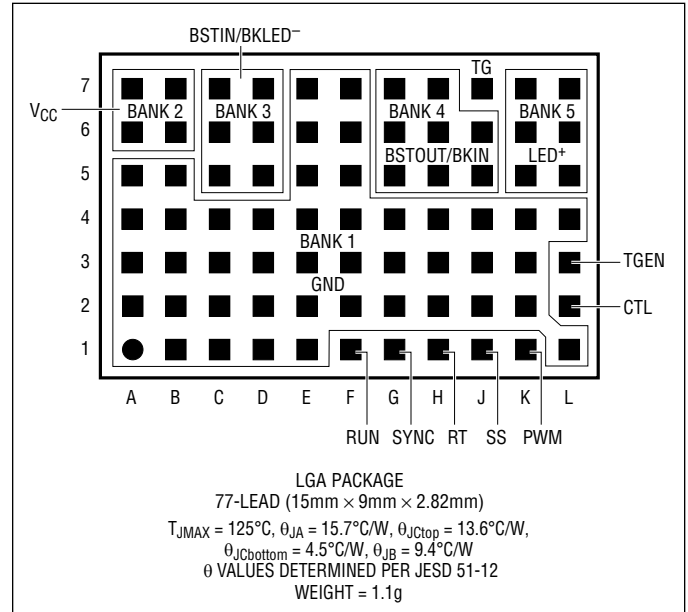

ORDER INFORMATION

| PART NUMBER | PAD OR BALL FINISH | PART MARKING* | | PACKAGE TYPE | MSL RATING | TEMPERATURE RANGE (Note 4) |
|-----------------|--------------------|---------------|-------------|--------------|------------|----------------------------|
| | | DEVICE | FINISH CODE | | | |
| LTM8042EV#PBF | Au (RoHS) | LTM8042V | e4 | LGA | 3 | -40°C to 125°C |
| LTM8042IV#PBF | Au (RoHS) | LTM8042V | e4 | LGA | 3 | -40°C to 125°C |
| LTM8042EV-1#PBF | Au (RoHS) | LTM8042V-1 | e4 | LGA | 3 | -40°C to 125°C |
| LTM8042IV-1#PBF | Au (RoHS) | LTM8042V-1 | e4 | LGA | 3 | -40°C to 125°C |

Consult Marketing for parts specified with wider operating temperature ranges. *Device temperature grade is indicated by a label on the shipping container. Pad or ball finish code is per IPC/JEDEC J-STD-609.

- Terminal Finish Part Marking:
www.linear.com/leadfree

- Recommended LGA and BGA PCB Assembly and Manufacturing Procedures:
www.linear.com/umodule/pcbassembly
- LGA and BGA Package and Tray Drawings:
www.linear.com/packaging

ELECTRICAL CHARACTERISTICS

The ● denotes the specifications which apply over the full internal operating temperature range, otherwise specifications are at $T_A = 25^\circ\text{C}$. $V_{CC} = 5\text{V}$, buck mode with 4Ω load.

| SYMBOL | PARAMETER | CONDITIONS | MIN | TYP | MAX | UNITS |
|--|---------------------------------------|---|------|------|------|---------------|
| $V_{CC(\text{MIN})}$ | Minimum Input DC Voltage | | ● 3 | | | V |
| I_{LED} | LTM8042 LED Current | CTL Open | 0.9 | | 1.05 | A |
| | | $R_{\text{CTL}} = 6.81\text{k}$ | 0.45 | 0.5 | 0.55 | A |
| | LTM8042-1 LED Current | CTL Open | 0.34 | | 0.39 | A |
| | | $R_{\text{CTL}} = 6.81\text{k}$ | 0.17 | | 0.20 | A |
| V_{CLAMP} | Open LED Clamp Voltage | Boost Mode, LED ⁺ Open | | 36 | | V |
| $\Delta I_{\text{OUT}}/I_{\text{OUT}}$ | Output Current Line Regulation | LTM8042, $6\text{V} < \text{BSTOUT}/\text{BKIN} < 30\text{V}$ | | 0.5 | | % |
| | | LTM8042-1, $6\text{V} < \text{BSTOUT}/\text{BKIN} < 30\text{V}$ | | 0.5 | | % |
| I_{QVCC} | V_{CC} Supply Current | PWM = 0V | | 4.2 | | mA |
| | | RUN = 0V | | 0.1 | 1 | μA |
| f_{SW} | Switching Frequency | RT = 90.9k | 0.22 | 0.25 | 0.27 | MHz |
| | | RT = 22.1k | 0.68 | 0.8 | 0.92 | MHz |
| | | RT = 6.04k | 1.7 | 2 | 2.3 | MHz |
| I_{SS} | Soft-Start Pin Current | SS = 0.5V, Out of Pin | 6 | 9 | 12 | μA |
| f_{SYNC} | Synchronization Frequency Range | | 0.3 | | 2.5 | MHz |
| I_{SYNC} | SYNC Pull-Down Current (Into the Pin) | $V_{\text{SYNC}} = 2\text{V}$ | | 60 | | μA |
| $V_{\text{SYNC(IL)}}$ | SYNC Input Low | | | | 0.4 | V |
| $V_{\text{SYNC(IH)}}$ | SYNC Input High | | 1.5 | | | V |
| I_{CTL} | CTL Input Bias Current | CTL = 0V, Flows Out of Pin | | 100 | | μA |
| $V_{\text{RUN(IH)}}$ | RUN Input Voltage High | | 1.5 | | | V |
| $V_{\text{RUN(IL)}}$ | RUN Input Voltage Low | | | | 0.4 | V |
| I_{RUN} | RUN Pin Bias Current | | | 60 | 100 | μA |
| $V_{\text{PWM(IH)}}$ | PWM Input Voltage High | | 1.5 | | | V |
| $V_{\text{PWM(IL)}}$ | PWM Input Voltage Low | | | | 0.4 | V |
| I_{PWM} | PWM Pin Bias Current | | | 60 | 120 | μA |
| $V_{\text{TG(OH)}}$ | TG Output High Voltage | Relative to LED ⁺ , 100k from LED ⁺ to TG | | 0 | | V |
| $V_{\text{TG(OL)}}$ | TG Output Low Voltage | Relative to LED ⁺ , 100k from LED ⁺ to TG | | -7 | | V |
| $V_{\text{TGEN(IH)}}$ | TGEN Input Voltage High | PWM = 0V | 1.5 | | | V |
| $V_{\text{TGEN(IL)}}$ | TGEN Input Voltage Low | | | | 0.4 | V |
| I_{TGEN} | TGEN Pin Bias Current | | | 100 | 200 | μA |

Note 1: Stresses beyond those listed under Absolute Maximum Ratings may cause permanent damage to the device. Exposure to any Absolute Maximum Rating condition for extended periods may affect device reliability and lifetime.

Note 2: Absolute maximum voltage at V_{CC} , RUN, PWM, TGEN, BSTIN/BKLED⁻ pins is 40V for non-repetitive one second transients and 30V for continuous operation.

Note 3: The LTM8042E/LTM8042E-1 are guaranteed to meet performance specifications from 0°C to 125°C ambient. Specifications over the full -40°C to 125°C internal operating temperature range are assured by design, characterization and correlation with statistical process controls.

The LTM8042/LTM8042-1 are guaranteed to meet specifications over the full -40°C to 125°C internal operating temperature range. Note that the maximum internal temperature is determined by specific operating conditions in conjunction with board layout, the rated package thermal resistance and other environmental factors.

Note 4: This device includes overtemperature protection that is intended to protect the device during momentary overload conditions. Junction temperature will exceed the maximum internal operating temperature when overtemperature protection is active. Continuous operation above the specified maximum operating junction temperature may impair device reliability.

TYPICAL PERFORMANCE CHARACTERISTICS $T_A = 25^\circ\text{C}$, unless otherwise noted.

LTM8042

Efficiency vs V_{IN} , Boost Operation, 6.8V at 1A LED String

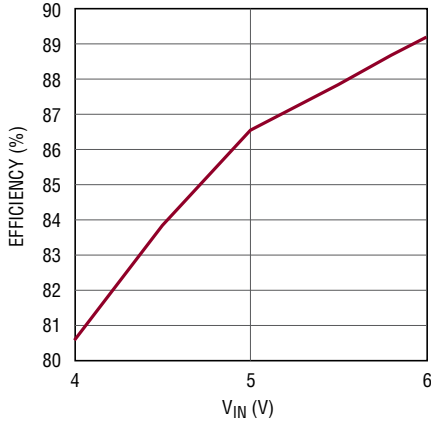

80421 G01

Efficiency vs V_{IN} , Boost Operation, 10.1V at 1A LED String

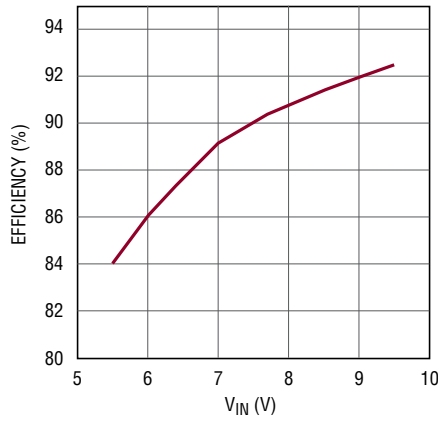

80421 G02

Efficiency vs V_{IN} , Boost Operation, 13.4V at 1A LED String

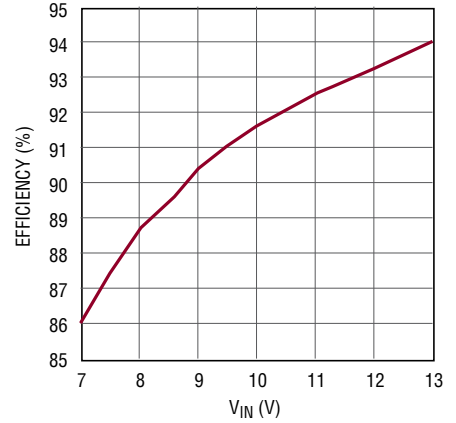

80421 G03

Efficiency vs V_{IN} , Boost Operation, 16.7V at 1A LED String

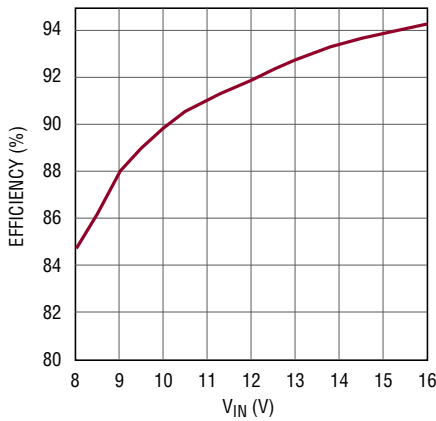

80421 G04

Efficiency vs V_{IN} , Boost Operation, 20.1V at 1A LED String

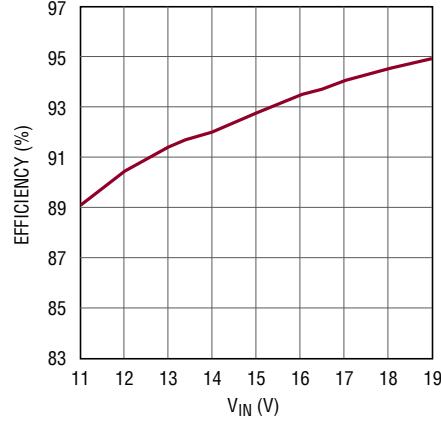

80421 G05

Efficiency vs V_{IN} , Boost Operation, 23.4V at 1A LED String

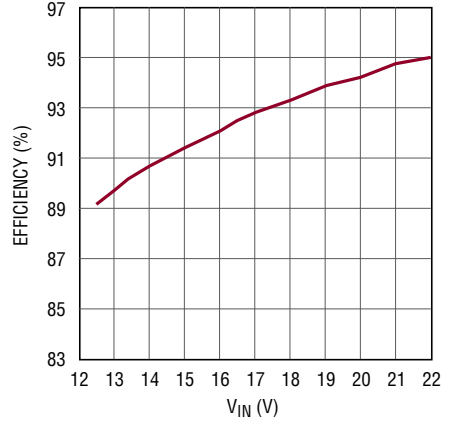

80421 G06

Efficiency vs V_{IN} , Boost Operation, 26.8V at 1A LED String

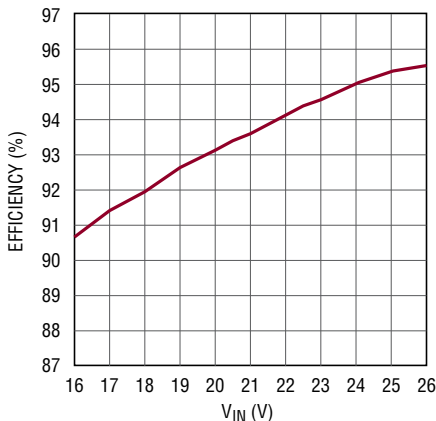

80421 G07

Efficiency vs V_{IN} , Buck Mode, 3.5V at 1A LED String

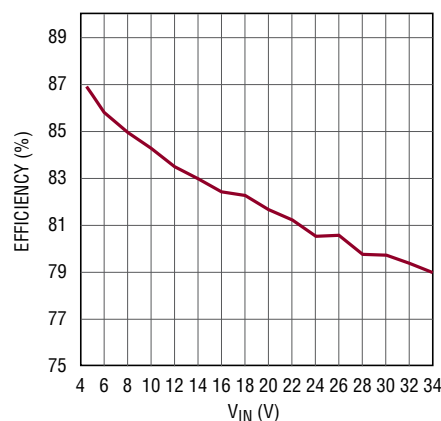

80421 G08

Efficiency vs V_{IN} , Buck Mode, 6.8V at 1A LED String

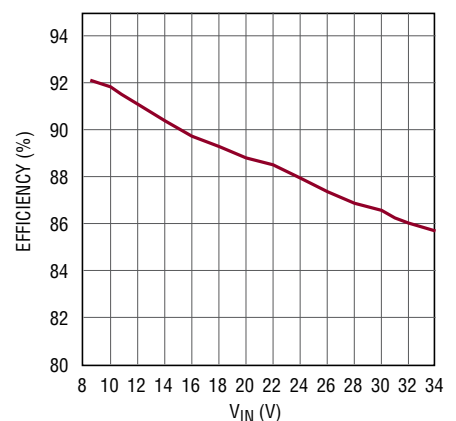

80421 G09

80421fb

TYPICAL PERFORMANCE CHARACTERISTICS $T_A = 25^\circ\text{C}$, unless otherwise noted.

LTM8042

Efficiency vs V_{IN} , Buck Mode, 10.1V at 1A LED String

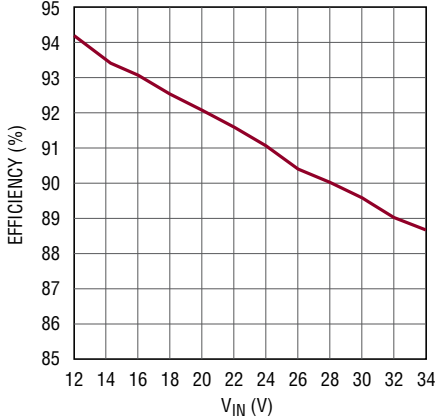

80421 G10

Efficiency vs V_{IN} , Buck Mode, 13.4V at 1A LED String

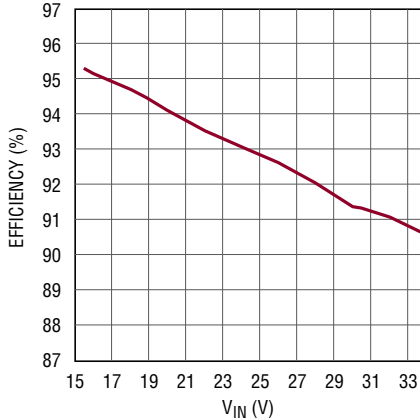

80421 G11

Efficiency vs V_{IN} , Buck Mode, 16.7V at 1A LED String

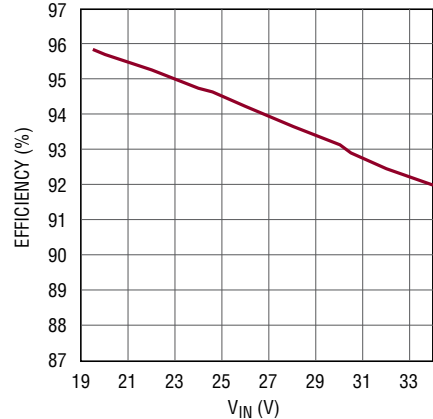

80421 G12

Efficiency vs V_{IN} , Buck-Boost Mode, 3.6V at 1A LED String

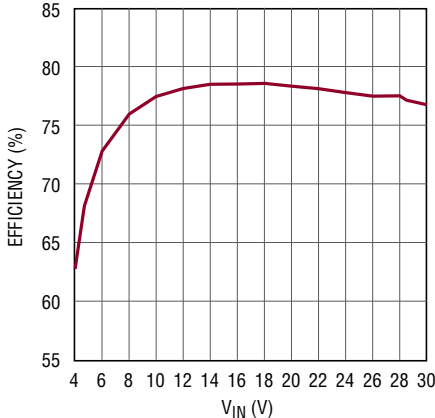

80421 G13

Efficiency vs V_{IN} , Buck-Boost Mode, 6.8V at 1A LED String

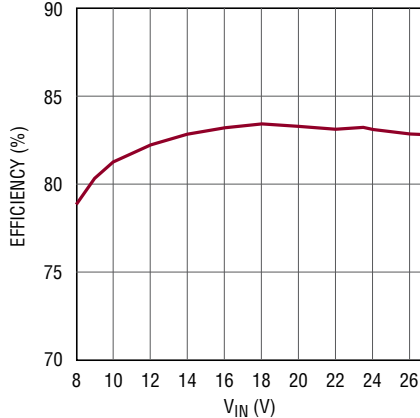

80421 G14

Efficiency vs V_{IN} , Buck-Boost Mode, 10.1V at 1A LED String

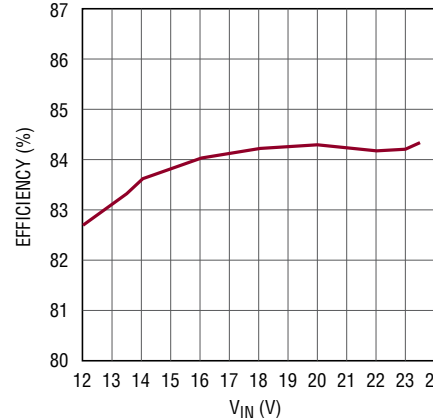

80421 G15

Efficiency vs V_{IN} , Buck-Boost Mode, 13.4V at 1A LED String

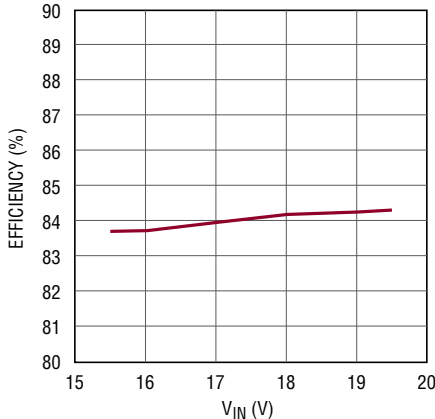

80421 G16

Maximum LED Current vs Input Voltage, Boost Operation

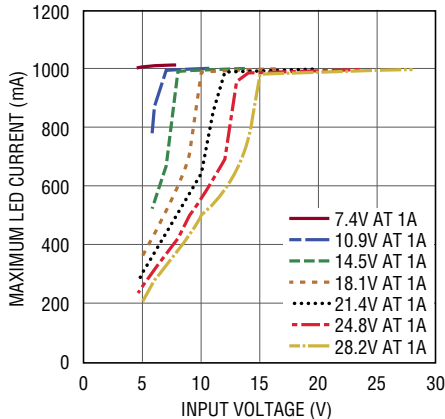

80421 G17

TYPICAL PERFORMANCE CHARACTERISTICS $T_A = 25^\circ\text{C}$, unless otherwise noted.

LTM8042

Maximum LED Current vs V_{IN} , Buck Mode

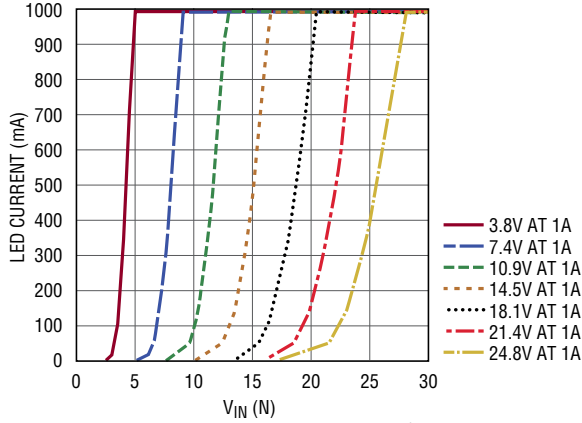

Maximum LED Current vs Input Voltage, Buck-Boost Mode

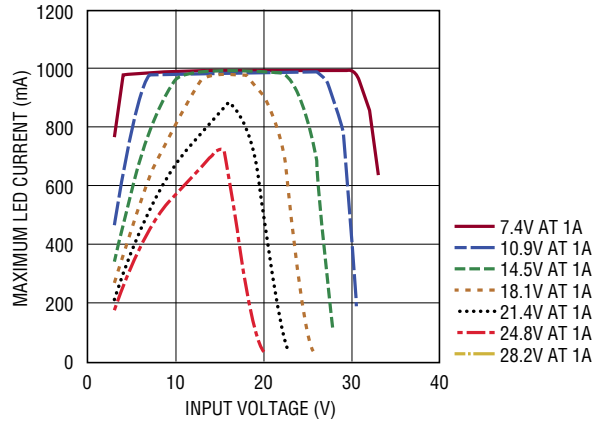

LED Current vs CTL Voltage

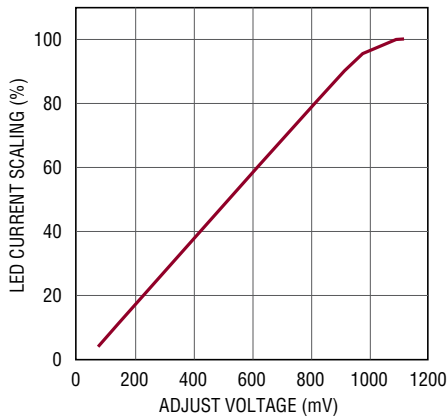

Quiescent Current vs Input Voltage, Open LED

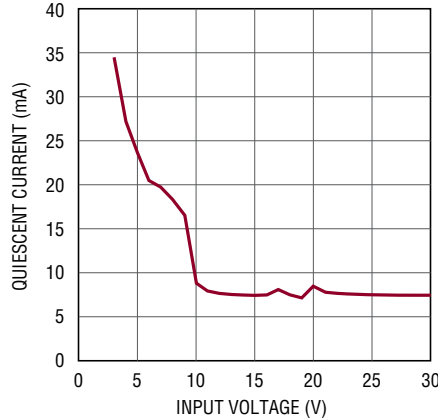

Junction Temperature Rise vs Load, Boost Operation, 8.3V at 1A LED String

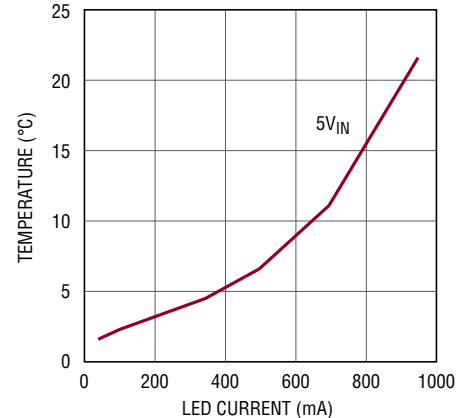

Junction Temperature Rise vs Load, Boost Operation, 10.9V at 1A LED String

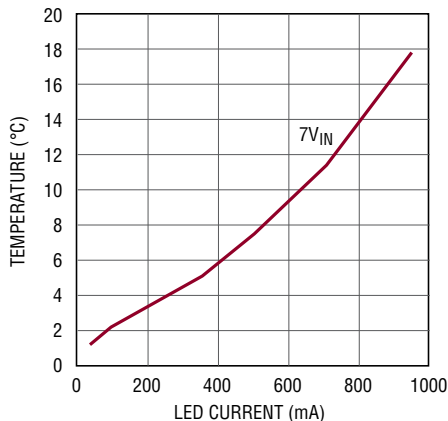

Junction Temperature Rise vs Load, Boost Operation, 13.6V at 1A LED String

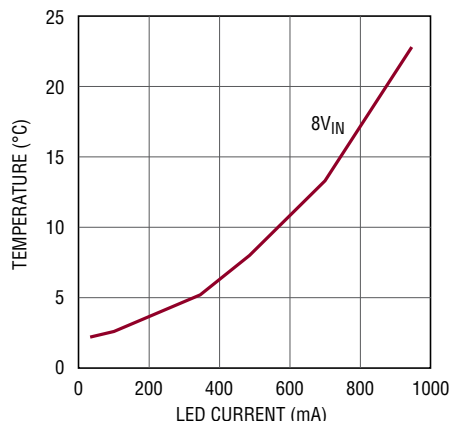

Junction Temperature Rise vs Load, Boost Operation, 18.1V at 1A LED String

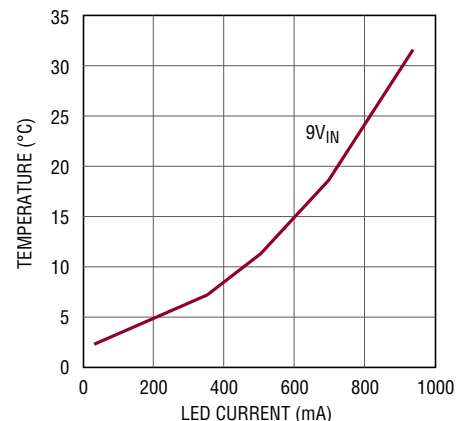

TYPICAL PERFORMANCE CHARACTERISTICS $T_A = 25^\circ\text{C}$, unless otherwise noted.

LTM8042

Junction Temperature Rise vs Load, Buck Mode, 2.9V at 1A LED String

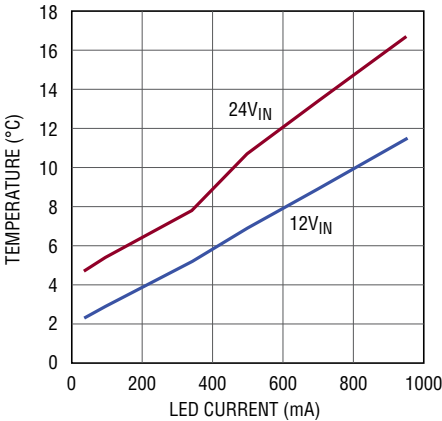

80421 G26

Junction Temperature Rise vs Load, Buck Mode, 3.8V at 1A LED String

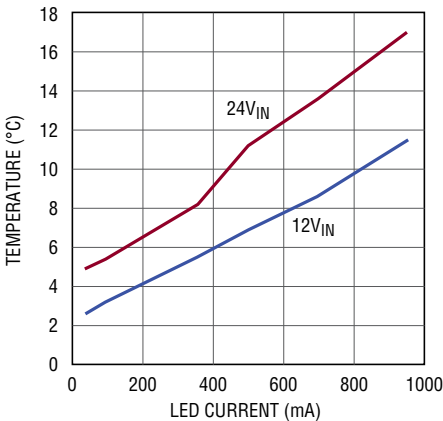

80421 G27

Junction Temperature Rise vs Load, Buck Mode, 8.3V at 1A LED String

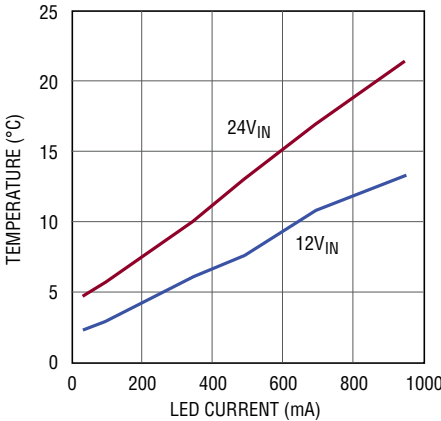

80421 G28

Junction Temperature Rise vs Load, Buck Mode, 10.9V at 1A LED String

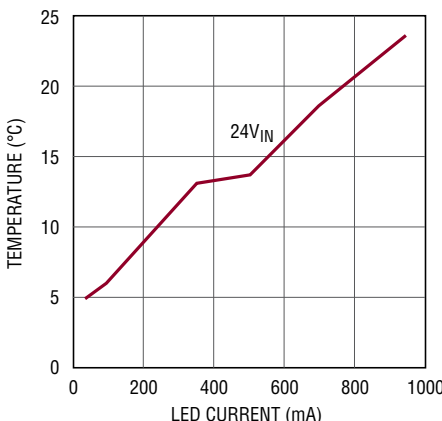

80421 G29

Junction Temperature Rise vs Load, Buck Mode, 13.6V at 1A LED String

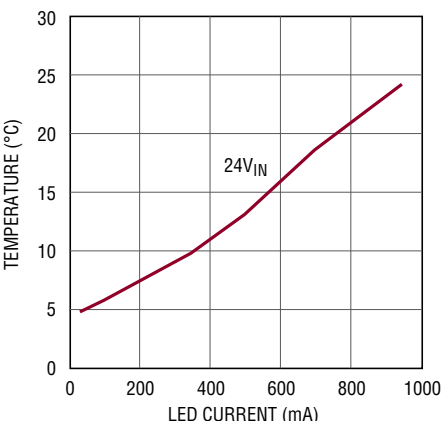

80421 G30

Junction Temperature Rise vs Load, Buck Mode, 18.1V at 1A LED String

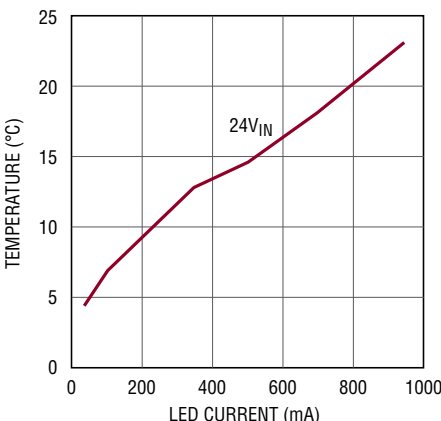

80421 G31

Junction Temperature Rise vs Load, Buck-Boost Mode, 2.9V at 1A LED String

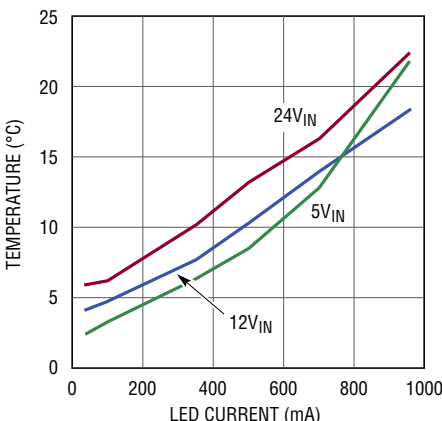

80421 G32

Junction Temperature Rise vs Load, Buck-Boost Mode, 3.8V at 1A LED String

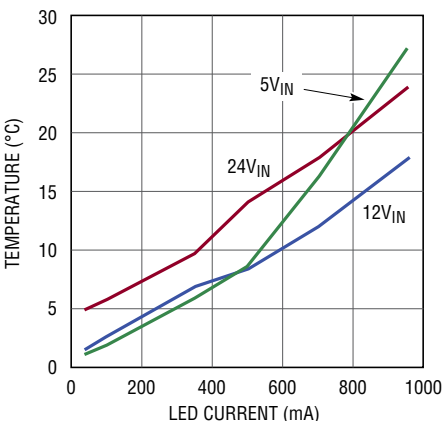

80421 G33

Junction Temperature Rise vs Load, Buck-Boost Mode, 8.3V at 1A LED String

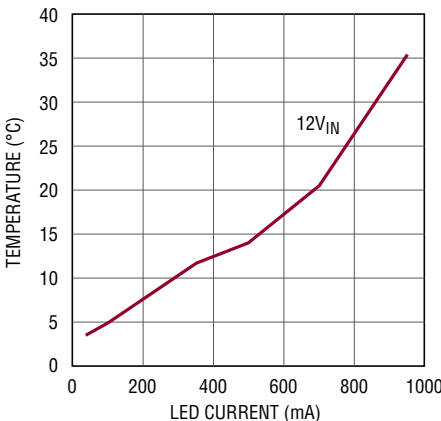

80421 G34

80421fb

LTM8042/LTM8042-1

TYPICAL PERFORMANCE CHARACTERISTICS $T_A = 25^\circ\text{C}$, unless otherwise noted.

LTM8042

Junction Temperature Rise vs Load, Buck-Boost Mode, 10.9V at 1A LED String

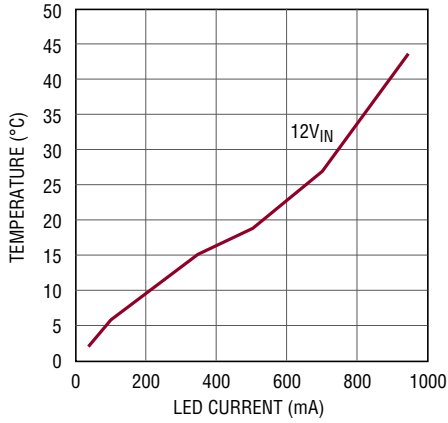

80421 G35

Junction Temperature Rise vs Load, Buck-Boost Mode, 13.6V at 1A LED String

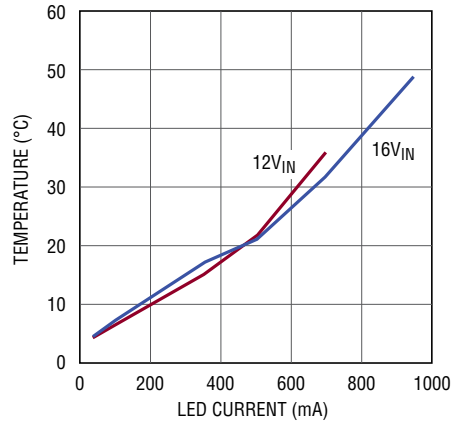

80421 G36

Junction Temperature Rise vs Load, Buck-Boost Mode, 15.5V at 350mA LED String

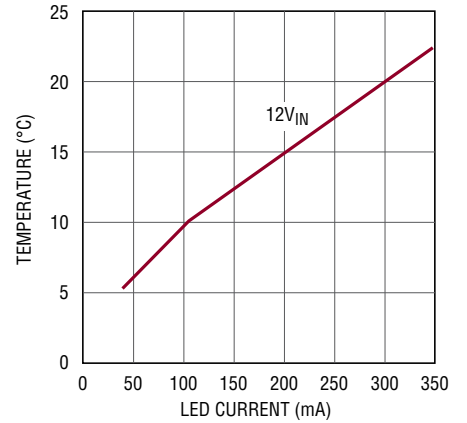

80421 G37

LTM8042/LTM8042-1

RUN Pin Current vs Voltage

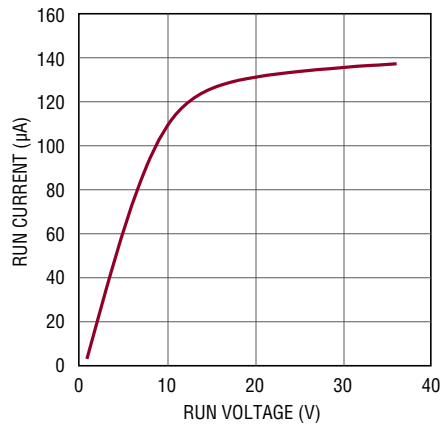

80421 G38

LTM8042-1

Efficiency vs V_{IN} , Boost Operation, 6.7V at 350mA LED String

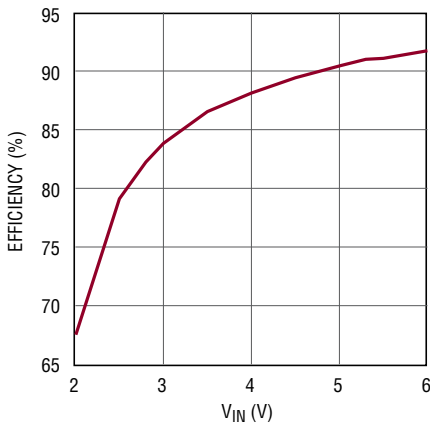

80421 G39

Efficiency vs V_{IN} , Boost Operation, 9.7V at 350mA LED String

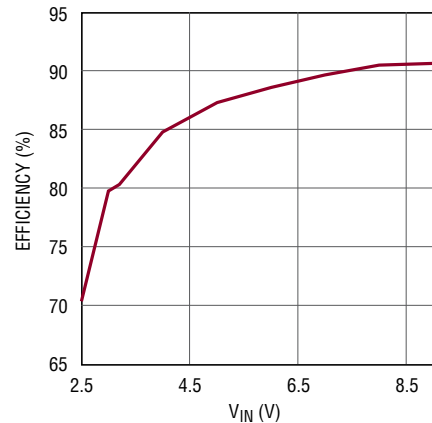

80421 G40

Efficiency vs V_{IN} , Boost Operation, 12.6V at 350mA LED String

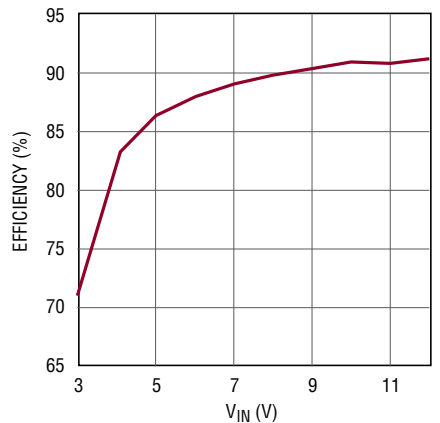

80421 G41

80421fb

TYPICAL PERFORMANCE CHARACTERISTICS $T_A = 25^\circ\text{C}$, unless otherwise noted.

LTM8042-1

Efficiency vs V_{IN} , Boost Operation, 15.6V at 350mA LED String

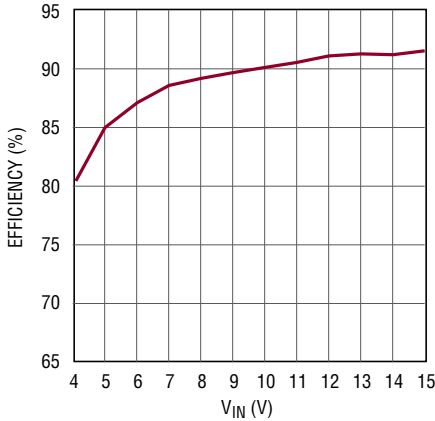

80421 G42

Efficiency vs V_{IN} , Boost Operation, 18.6V at 350mA LED String

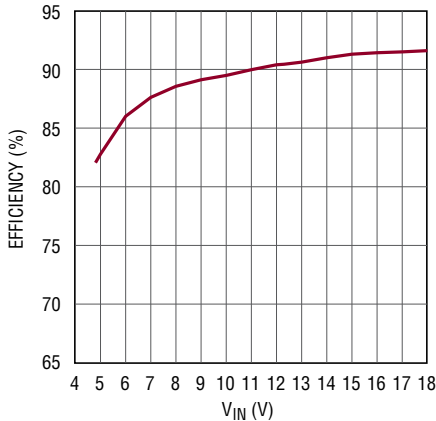

80421 G43

Efficiency vs V_{IN} , Boost Operation, 21.6V at 350mA LED String

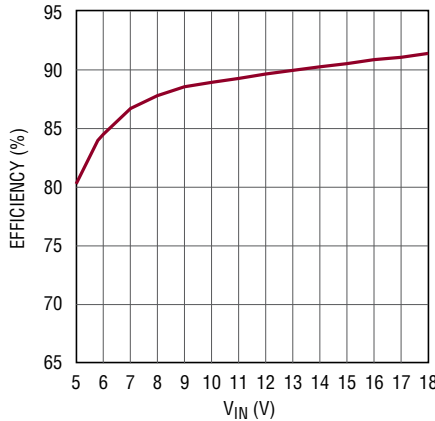

80421 G44

Efficiency vs V_{IN} , Boost Operation, 24.8V at 350mA LED String

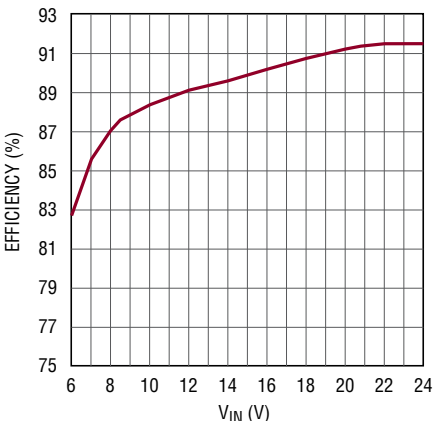

80421 G45

Efficiency vs V_{IN} , Buck Mode, 3.7V at 350mA LED String

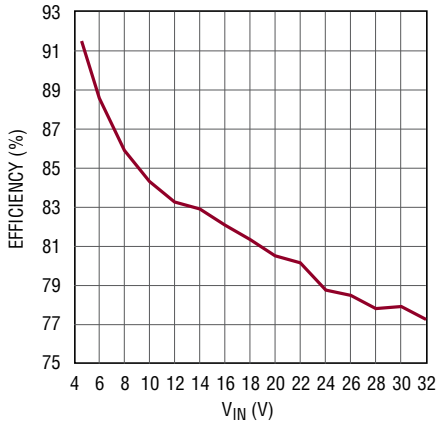

80421 G46

Efficiency vs V_{IN} , Buck Mode, 6.7V at 350mA LED String

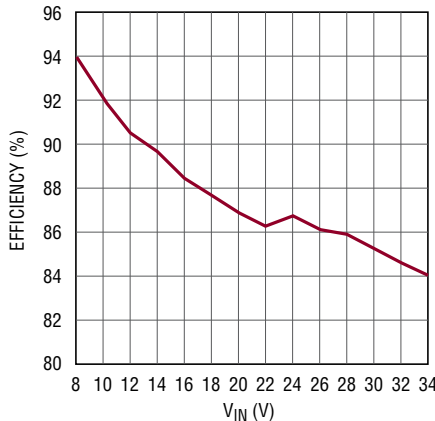

80421 G47

Efficiency vs V_{IN} , Buck Mode, 9.7V at 350mA LED String

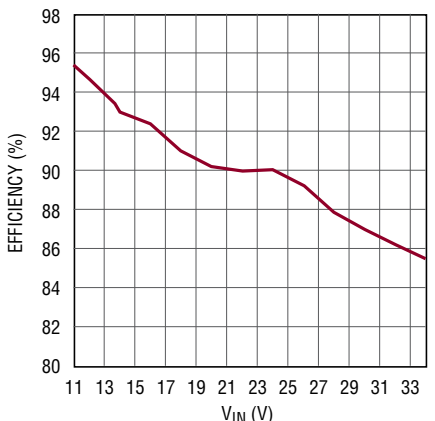

80421 G48

Efficiency vs V_{IN} , Buck Mode, 12.6V at 350mA LED String

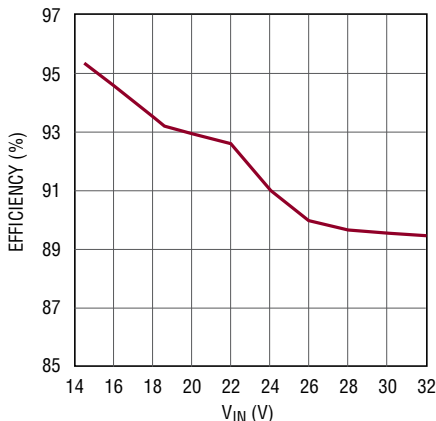

80421 G49

Efficiency vs V_{IN} , Buck Mode, 15.6V at 350mA LED String

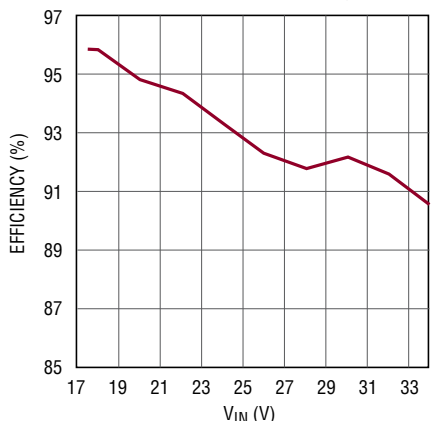

80421 G50

TYPICAL PERFORMANCE CHARACTERISTICS $T_A = 25^\circ\text{C}$, unless otherwise noted.

LTM8042-1

Efficiency vs V_{IN} , Buck Mode, 18.6V at 350mA LED String

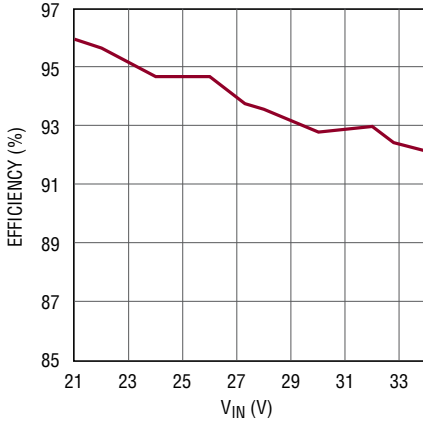

80421 G51

Efficiency vs V_{IN} , Buck-Boost Mode, 3.7V at 350mA LED String

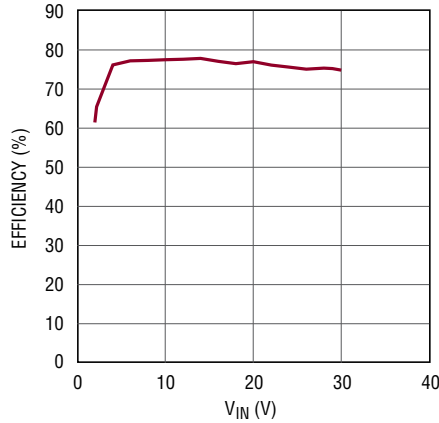

80421 G52

Efficiency vs V_{IN} , Buck-Boost Mode, 6.7V at 350mA LED String

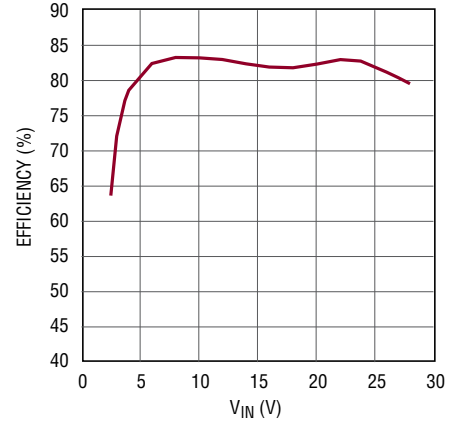

80421 G53

Efficiency vs V_{IN} , Buck-Boost Mode, 9.7V at 350mA LED String

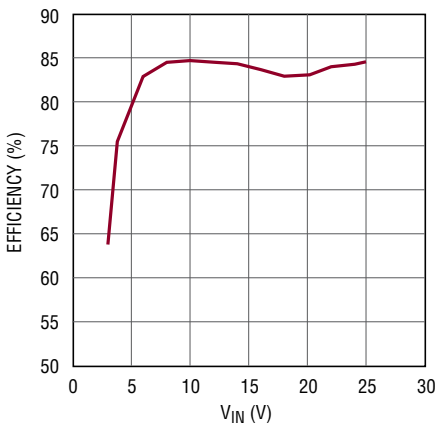

80421 G54

Efficiency vs V_{IN} , Buck-Boost Mode, 12.6V at 350mA LED String

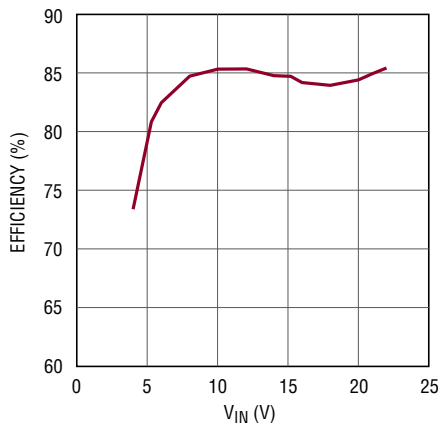

80421 G55

Efficiency vs V_{IN} , Buck-Boost Mode, 15.6V at 350mA LED String

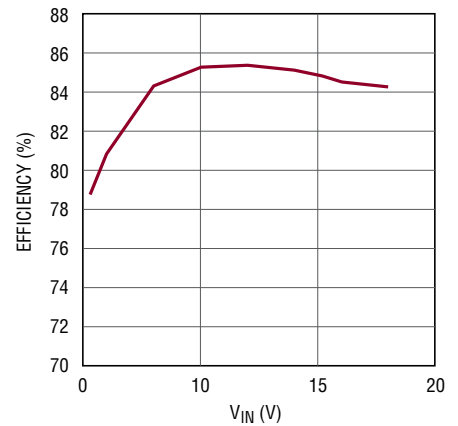

80421 G56

Efficiency vs V_{IN} , Buck-Boost Mode, 18.6V at 350mA LED String

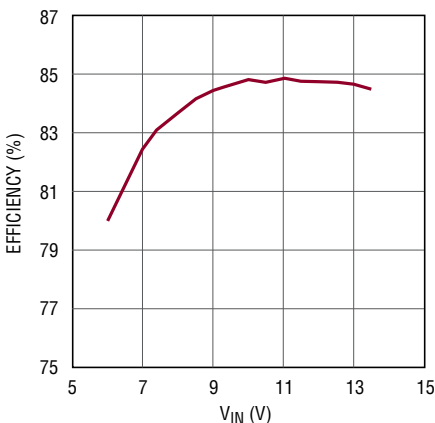

80421 G57

Maximum LED Current vs Input Voltage, Boost Operation

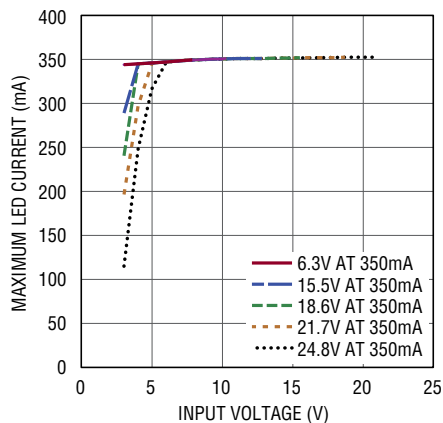

80421 G58

Maximum LED Current vs Input Voltage, Buck Mode

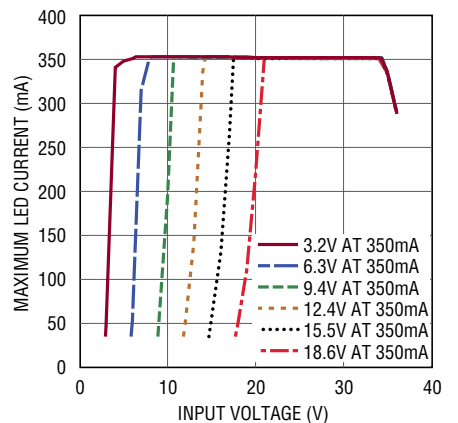

80421 G59

TYPICAL PERFORMANCE CHARACTERISTICS $T_A = 25^\circ\text{C}$, unless otherwise noted.

LTM8042-1

Maximum LED Current vs Input Voltage, Buck-Boost Mode

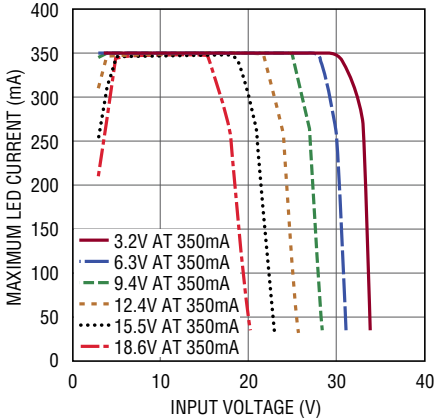

80421 G60

LED Current vs CTL Voltage

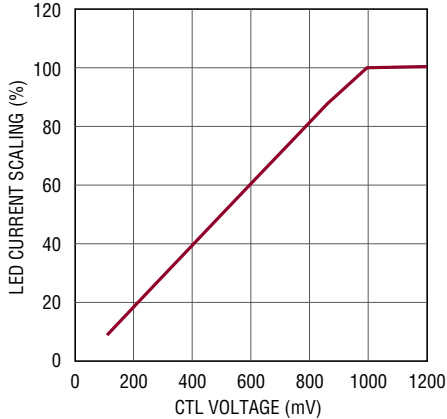

80421 G61

Quiescent Current vs Input Voltage, Open LED

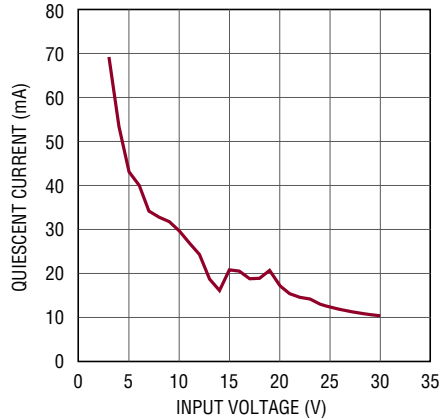

80421 G62

Junction Temperature Rise vs Load, Boost Operation, 6.8V at 350mA LED String

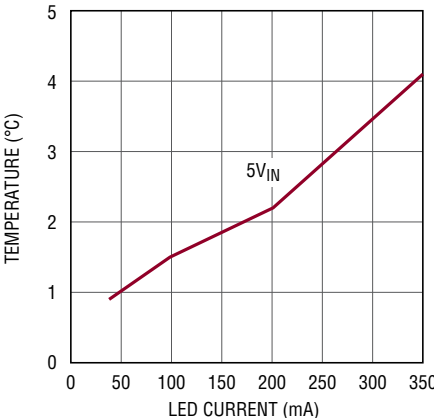

80421 G63

Junction Temperature Rise vs Load, Boost Operation, 9.4V at 350mA LED String

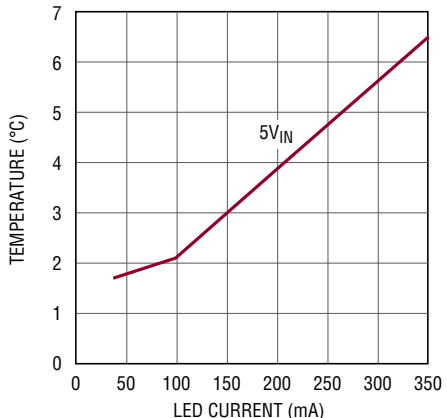

80421 G64

Junction Temperature Rise vs Load, Boost Operation, 11.2V at 350mA LED String

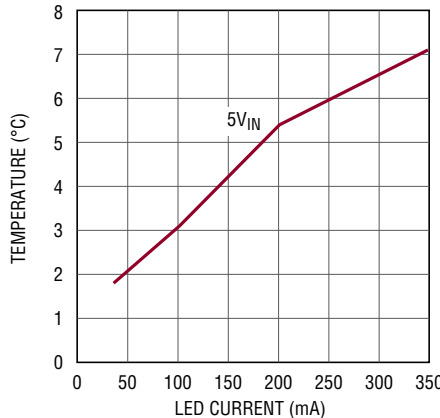

80421 G65

Junction Temperature Rise vs Load, Boost Operation, 15.5V at 350mA LED String

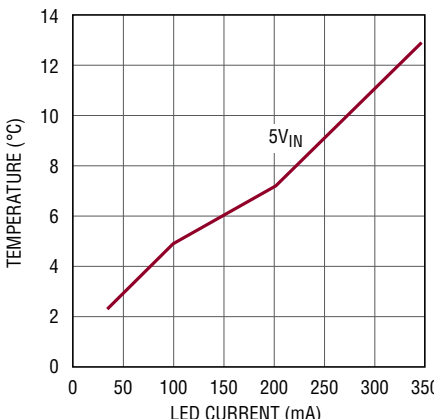

80421 G66

Junction Temperature Rise vs Load, Buck Mode, 2.3V at 350mA LED String

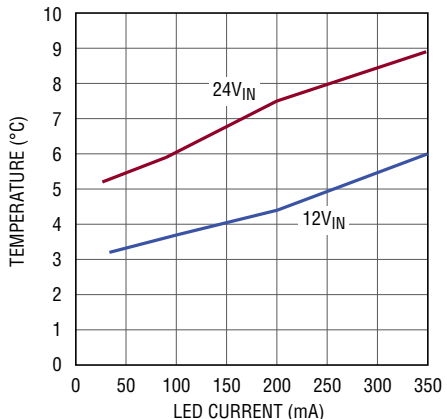

80421 G67

Junction Temperature Rise vs Load, Buck Mode, 3.2V at 350mA LED String

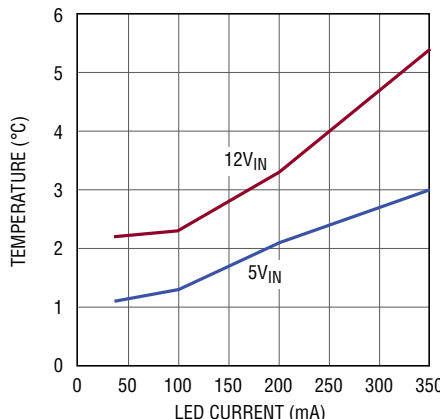

80421 G68

80421fb

TYPICAL PERFORMANCE CHARACTERISTICS $T_A = 25^\circ\text{C}$, unless otherwise noted.

LTM8042-1

Junction Temperature Rise vs Load, Buck Mode, 6.8V at 350mA LED String

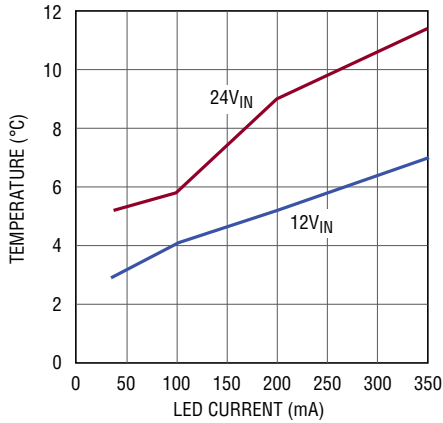

80421 G69

Junction Temperature Rise vs Load, Buck Mode, 9.4V at 350mA LED String

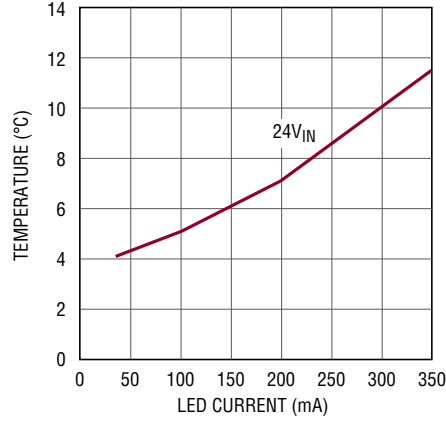

80421 G70

Junction Temperature Rise vs Load, Buck Mode, 11.2V at 350mA LED String

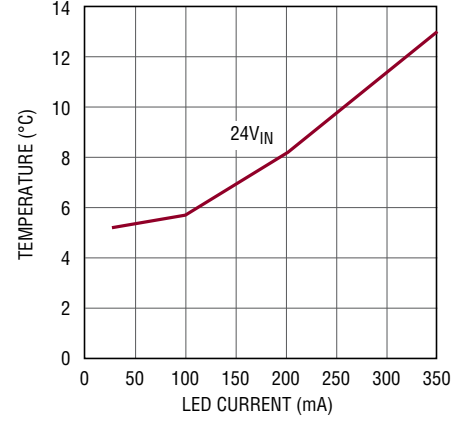

80421 G71

Junction Temperature Rise vs Load, Buck Mode, 15.5V at 350mA LED String

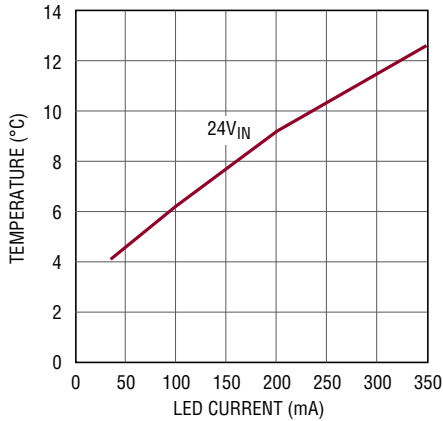

80421 G72

Junction Temperature Rise vs Load, Buck-Boost Mode, 2.3V at 350mA LED String

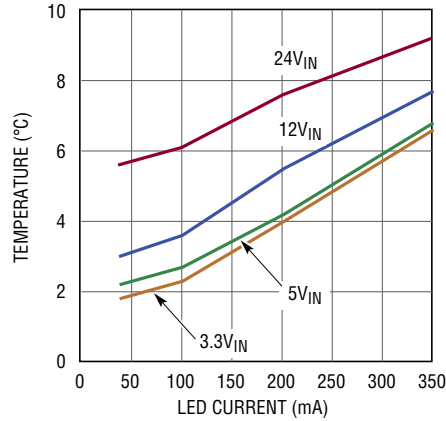

80421 G73

Junction Temperature Rise vs Load, Buck-Boost Mode, 3.2V at 350mA LED String

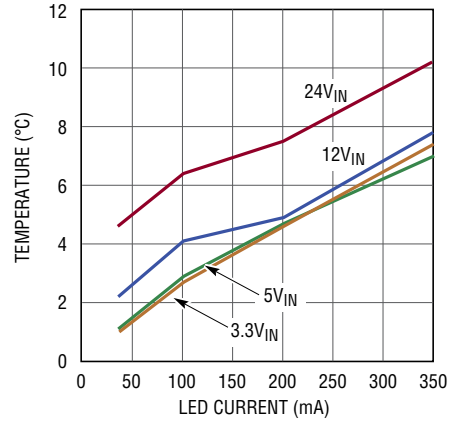

80421 G74

Junction Temperature Rise vs Load, Buck-Boost Mode, 6.8V at 350mA LED String

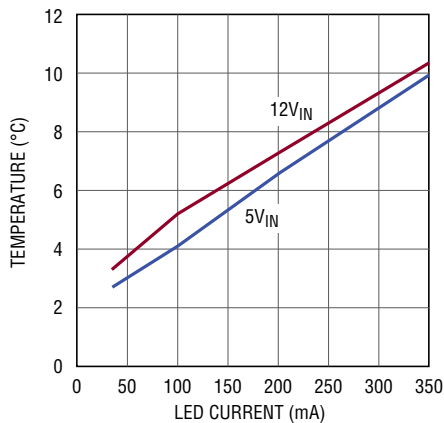

80421 G75

Junction Temperature Rise vs Load, Buck-Boost Mode, 9.4V at 350mA LED String

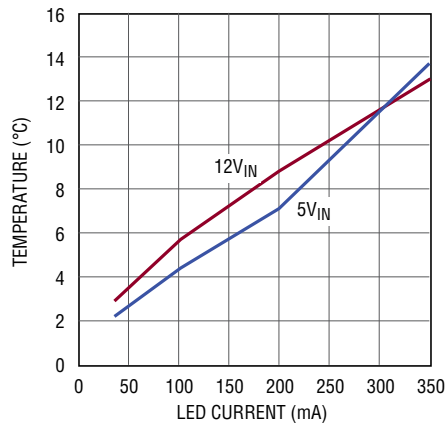

80421 G76

TYPICAL PERFORMANCE CHARACTERISTICS $T_A = 25^\circ\text{C}$, unless otherwise noted.

LTM8042-1

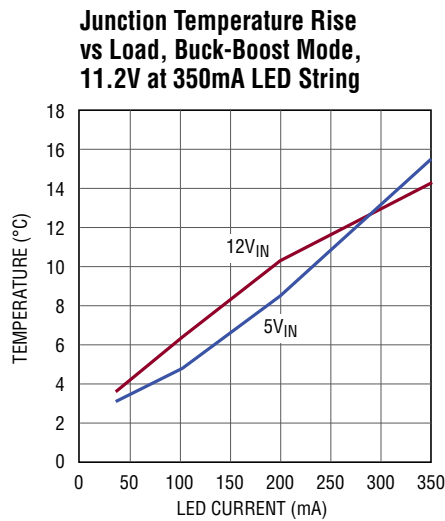

80421 G77

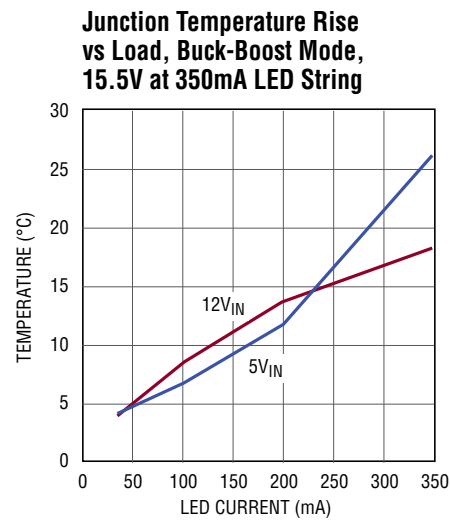

80421 G78

PIN FUNCTIONS

GND (Bank 1): Signal and Power Return. Tie these pads to a local ground plane below the LTM8042/LTM8042-1 and the circuit components. In most applications, the bulk of the heat flow out of the LTM8042/LTM8042-1 is through these pads, so the printed circuit design has a large impact on the thermal performance of the part. See the PCB Layout and Thermal Considerations sections for more details.

V_{CC} (Bank 2): Internal Housekeeping Power for the LTM8042/LTM8042-1. Connect to an external power source between 3V and 30V. The LTM8042/LTM8042-1 can withstand transients of 40V.

BSTIN/BKLED⁻ (Bank 3): Power Input for Boost Operation, as Well as the Cathode Connection for the LED String in Buck Mode. If the LTM8042/LTM8042-1 is used in boost mode, these pins must be locally decoupled.

BSTOUT/BKIN (Bank 4): Output of the Boost Converter, as Well as the Input for Buck Mode. If the LTM8042/LTM8042-1 is used in buck mode, these pins must be locally decoupled.

LED⁺ (Bank 5): Connect this to the anode of the LED string. This can also be connected to the PWM dimming MOSFET if used.

RUN (Pin F1): Module Enable. Tie to 1.5V or higher to enable the LTM8042/LTM8042-1 or 0.4V or less to disable device.

SYNC (Pin G1): Frequency Synchronization Pin. Tie an external clock signal here. The RT resistor should be chosen to program a switching frequency that is 20% slower than SYNC pulse frequency. Tie the SYNC pin to GND if this feature is not used.

RT (Pin H1): Timing Resistor Pin. Used to program the switching frequency of the LTM8042/LTM8042-1 by connecting a resistor from this pin to GND. The Applications Information section of the data sheet includes a table to determine the resistance value based on the desired switching frequency. Minimize capacitance at this pin.

SS (Pin J1): Soft-Start Pin. Place a soft-start capacitor here. Leave the pin open if not used.

PIN FUNCTIONS

TG (Pin J7): Top Gate Driver Output. In response to an active high PWM signal, this pin will drive the gate of an external series P-channel MOSFET device low. An internal 7V clamp protects the PFET gate. This pin can also be used to disconnect the load when RUN is pulled low. Leave TG unconnected if not used. Do not drive this pin with an external source.

PWM (Pin K1): Pulse Width Modulation Input Pin. A low signal turns off the LED string, disables the main switch and pulls the TG pin high. Drive above 1.55V to deliver current to the output. Tie the PWM pin to the RUN pin if not used. There is an equivalent 50k resistor from PWM pin to ground internally.

CTL (Pin L2): LED Current Adjustment Pin. Apply a voltage between approximately 1V and 0V to modulate the LED⁺ output current, or tie a resistor to GND to modulate the LED⁺ current. CTL is internally tied to a 2V precision reference via a 20k 1% resistor. Leave floating if unused.

TGEN (Pin L3): Top Gate (TG) Enable Input Pin. Tie to 1.5V or higher to enable the P-channel MOSFET driver function. Tie the TGEN pin to ground if the TG function is not used. There is an internal 40k resistor from TGEN to GND.

BLOCK DIAGRAM

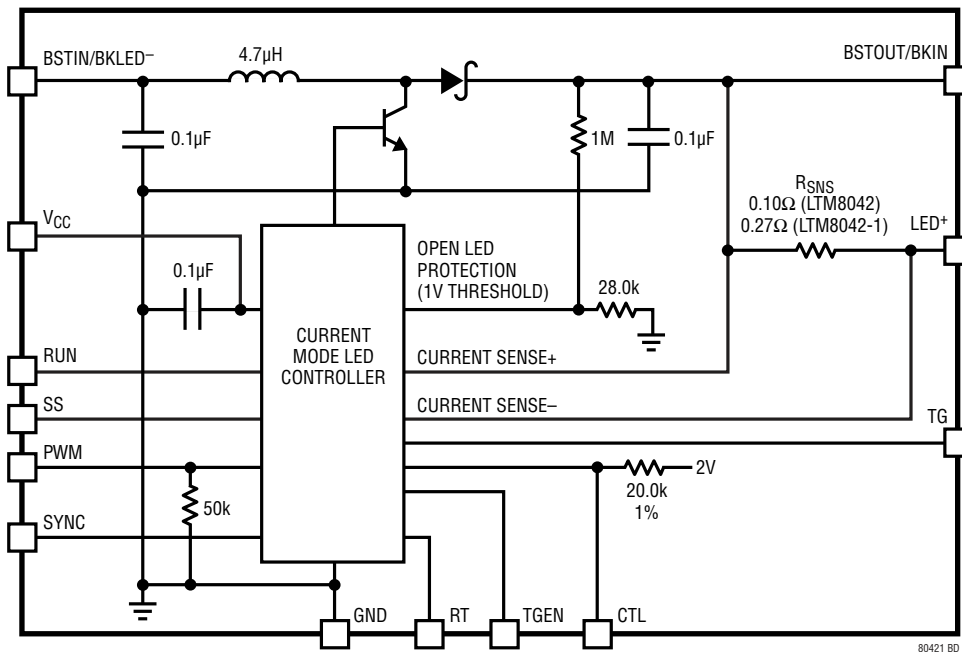

80421 BD

OPERATION

The LTM8042/LTM8042-1 is a complete, full featured, current mode regulator specifically designed to drive light emitting diodes (LEDs) or other loads where a constant current up to 1A (350mA for the LTM8042-1) is required.

The LTM8042/LTM8042-1 can operate in any of three LED drive topologies: boost, buck mode and buck-boost mode. The device features both analog and PWM dimming, a PWM P-channel MOSFET driver, and a suite of control functions: RUN control, soft-start, user programmable switching frequency, and external frequency synchronization.

Operation can be best understood by referring to the Block Diagram. The power stage is a boost converter that regulates the output current by reading the voltage across a power sense resistor that is in series with the output.

As with any boost topology, there is an uninterrupted current path between the input and output terminals. Current between these two terminals is not limited, so **the device is intolerant to a short-circuit or overload from any of the output terminals (LED⁺, BSTOUT/BKIN) to GND.**

There are two ways to dim a LED with the LTM8042/LTM8042-1. One way is to adjust the current on the LED array by setting the analog voltage on the CTL pin. The CTL pin is internally pulled up to a precision 2V reference through a 1% 20k resistor. Leaving the CTL pin floating sets the LED pin current to 1A. Reducing the voltage below 1.1V on the CTL pin proportionally reduces the current flowing out of LED⁺. This can be accomplished by connecting a resistor from the CTL pin to GND, forming a divider network with the internal 20k resistor, or by driving the CTL pin directly to a voltage source, such as a DAC.

The other way the LTM8042/LTM8042-1 can dim a LED array is by pulse width modulation using the PWM pin and an optional external P-channel MOSFET. The external P-channel MOSFET can be conveniently operated by the integrated gate driver at pin TG. The gate drive function can be enabled or disabled by the TGEN pin.

If the PWM pin is pulled high, the part operates normally. If the PWM pin is unconnected or pulled low, the LTM8042/LTM8042-1 stops switching and the internal control circuitry is held in its present state. This way, the LTM8042/LTM8042-1 “remembers” the current sourced from the LED⁺ output until PWM is pulled high again. This leads to a highly linear relationship between pulse width and output light, allowing for a large and accurate dimming range.

The RUN pin is used to deactivate the LTM8042/LTM8042-1. When the RUN pin is pulled to a logic low state, the device is shut down and draws typically less than 1μA of current.

The SS pin is used to limit inrush current during start-up. The LTM8042/LTM8042-1 integrates a current source with this function, so only a capacitor is necessary to establish the soft-start characteristics of the output current.

The switching frequency is set by applying a single resistor from the RT pin to GND, allowing operation anywhere from 250kHz to 2MHz, and the SYNC pin allows synchronization to an external source between 300kHz and 2.5MHz.

APPLICATIONS INFORMATION

For most applications, the design process is straight forward, summarized as follows:

1. Decide whether the LTM8042/LTM8042-1 should operate in boost, buck, or buck-boost mode.
2. Look at Tables 1 through 6 and find the line that best matches the input and output conditions of the system under consideration.
3. Connect C_{IN} , C_{OUT} , C_{VCC} and R_T as indicated in the appropriate table.
4. Connect the remaining pins as needed by the system requirements.

While these component combinations have been tested for proper operation, it is incumbent upon the user to verify proper operation over the intended system's line, load and environmental conditions.

If the desired LED current is not listed in Tables 1 through 6, set it by applying the proper voltage the CTL pin. Graphs of the LTM8042/LTM8042-1 LED current scaling vs CTL voltage are given in the Typical Performance Characteristics section. If a voltage source is not available to drive the CTL pin, a resistor may be applied from the CTL pin to GND. The CTL pin is internally pulled up to a 2V reference voltage through a 20k resistor (please see the Block Diagram for details).

Open LED Protection

The LTM8042/LTM8042-1 has internal open LED circuit protection. If the LED is absent or fails open, the LTM8042/LTM8042-1 clamps the voltage on the LED+ and BSTOUT/BKIN pin to protect the output against overvoltage. The internal boost switching converter then regulates its output to 36V. In buck mode, the full open LED voltage is stood off by the internal power Schottky diode. At high operating temperatures, the power Schottky reverse leakage current will rise. This increases the power dissipation within the diode, which raises the junction temperature. This temperature rise can be large, so care needs to be taken at high operating temperatures.

Setting the Switching Frequency

The LTM8042/LTM8042-1 uses a constant frequency architecture that can be programmed over a 250kHz to 2MHz range with a single external timing resistor from the RT pin to ground. Table 7 shows suggested R_T selections for a variety of switching frequencies.

Table 7. Switching Frequency vs R_T

| SWITCHING FREQUENCY (kHz) | R_T (k Ω) |
|---------------------------|---------------------|
| 250 | 86.6 |
| 500 | 37.4 |
| 800 | 21.0 |
| 1000 | 15.8 |
| 1500 | 9.09 |
| 2000 | 6.04 |

The other way to set the operating frequency of the LTM8042/LTM8042-1 is to drive the SYNC pin with an external signal. For proper operation, a resistor should be connected at the RT pin and be able to generate a switching frequency 20% lower than the external clock when the external clock is absent.

In general, a lower switching frequency should be used where either very high or very low switching duty cycle operation is required, or high efficiency is desired. Selection of a higher switching frequency will allow use of smaller value external components and yield a smaller solution size and profile.

Operating Modes

The LTM8042/LTM8042-1 employs a ground referred power switch to implement a boost power switching circuit. As such, it can be used to implement the three most popular LED driving topologies: boost, buck mode, and buck-boost mode. Example layouts of each operating mode are given in Figures 2 through 4 and schematics are shown in the Typical Applications section.

APPLICATIONS INFORMATION

PCB Layout

Most of the headaches associated with PCB layout have been alleviated or even eliminated by the high level of integration of the LTM8042/LTM8042-1. The device is nevertheless a switching power supply, and care must be taken to minimize EMI and ensure proper operation. Even with the high level of integration, you may fail to achieve specified operation with a haphazard or poor layout. See Figures 2, 3 and 4 for suggested layouts of boost, buck and buck-boost operating modes.

Ensure that the grounding and heat sinking are acceptable. A few rules to keep in mind are:

1. Place the R_T resistor as close as possible to its respective pins.
2. Place the C_{IN} and C_{VCC} capacitor as close as possible to the V_{IN} and GND connections of the LTM8042/LTM8042-1.
3. Place the C_{OUT} capacitor as close as possible to the BSTOUT/BKIN or BSTIN/BKLED⁻ and GND connection of the LTM8042/LTM8042-1.

4. Place the C_{IN} , C_{VCC} and C_{OUT} capacitors such that their ground current flows directly adjacent to or underneath the LTM8042/LTM8042-1.
5. Connect all of the GND connections to as large a copper pour or plane area as possible on the top layer. Avoid breaking the ground connection between the external components and the LTM8042/LTM8042-1.

Use vias to connect the GND copper area to the board's internal ground planes. Liberally distribute these GND vias to provide both a good ground connection and thermal path to the internal planes of the printed circuit board. Pay attention to the location and density of the thermal vias in Figures 2 through 4. The LTM8042/LTM8042-1 can benefit from the heat sinking afforded by vias that connect to internal GND planes at these locations, due to their proximity to internal power handling components. The optimum number of thermal vias depends upon the printed circuit board design. For example, a board might use very small via holes. It should employ more thermal vias than a board that uses larger holes.

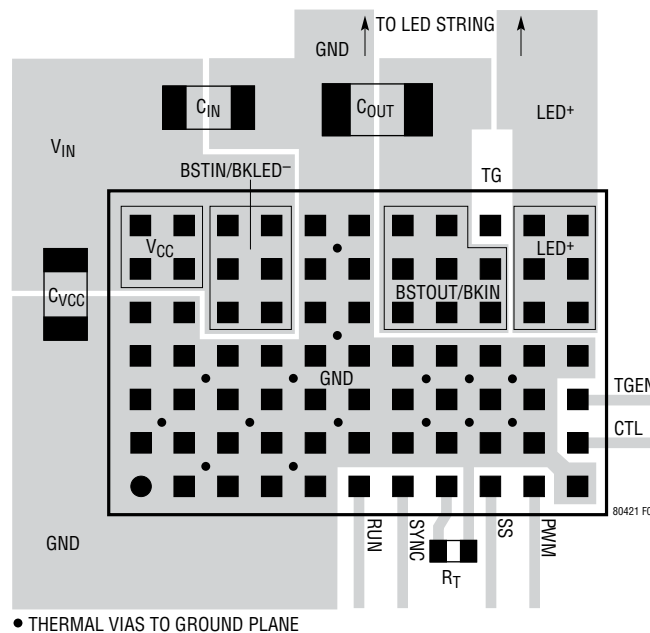
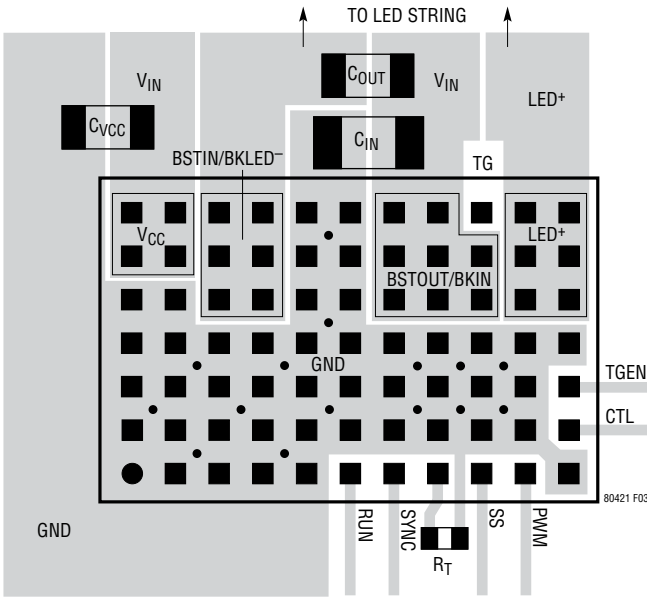

Figure 2. Suggested Layout for Boost Operation

APPLICATIONS INFORMATION



• THERMAL VIAS TO GROUND PLANE

Figure 3. Suggested Layout for Buck Mode

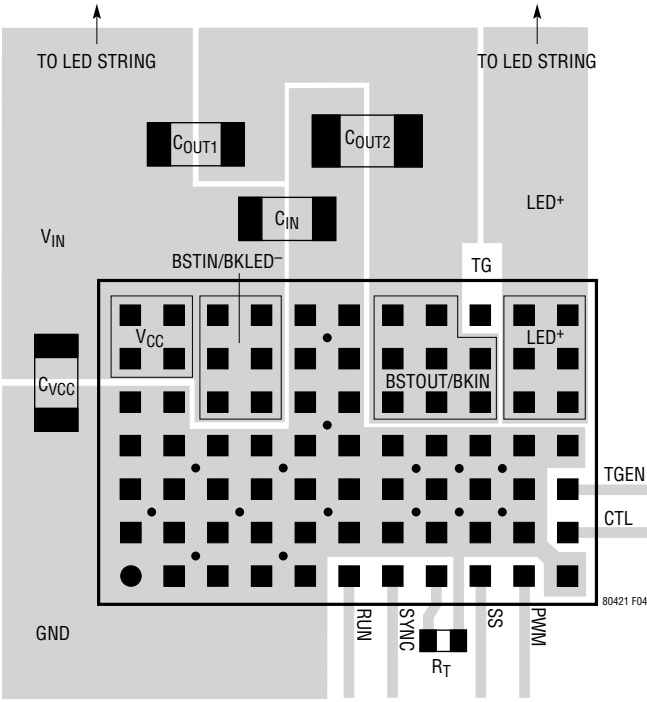

• THERMAL VIAS TO GROUND PLANE

Figure 4. Suggested Layout for Buck-Boost Mode

APPLICATIONS INFORMATION

Table 1. LTM8042 Recommended Values and Configuration for Boost ($T_A = 25^\circ\text{C}$)

| V_{IN} RANGE (BSTIN/ BKLED ⁻) | V_{CC} | C_{IN} (BSTIN/BKLED ⁻ TO GND) | C_{OUT} (BSTOUT/BKIN TO GND) | LED STRING VOLTAGE (LED ⁺ TO GND) | LED STRING CURRENT | R_{CTL} | RT (OPTI- MAL) | f (OPTI- MAL) | RT (MIN) | f (MAX) |
|--|-------------------------------------|--|--------------------------------------|--|--------------------------|-----------|----------------------|---------------------|-------------|------------|
| 3V to 3.6V | Connect to BSTIN/BKLED ⁻ | 1 μ F 0805 X7R 10V | 1 μ F 0805 X7R 10V | 4V to 6V | 35mA | 523 | 86.6k | 250k | 37.4k | 500k |
| 3V to 5.1V | Connect to BSTIN/BKLED ⁻ | 1 μ F 0805 X7R 10V | 1 μ F 0805 X7R 10V | 6V to 9V | 35mA | 523 | 76.8k | 275k | 37.4k | 500k |
| 3V to 6.3V | Connect to BSTIN/BKLED ⁻ | 1 μ F 0805 X7R 10V | 1 μ F 0805 X7R 16V | 8V to 12V | 35mA | 523 | 69.8k | 300k | 37.4k | 500k |
| 3V to 9.3V | Connect to BSTIN/BKLED ⁻ | 1 μ F 0805 X7R 10V | 1 μ F 0805 X7R 16V | 12V to 16V | 35mA | 523 | 48.7k | 400k | 30.1k | 600k |
| 3V to 10V | Connect to BSTIN/BKLED ⁻ | 1 μ F 0805 X7R 10V | 1 μ F 0805 X7R 25V | 15V to 21V | 35mA | 523 | 37.4k | 500k | 27.4k | 650k |
| 3V to 12.6V | Connect to BSTIN/BKLED ⁻ | 1 μ F 0805 X7R 16V | 1 μ F 0805 X7R 25V | 18V to 24V | 35mA | 523 | 33.2k | 550k | 24.9k | 700k |
| 3.7V to 15V | Connect to BSTIN/BKLED ⁻ | 1 μ F 0805 X7R 16V | 1 μ F 0805 X7R 50V | 24V to 32V | 35mA | 523 | 30.1k | 600k | 24.9k | 700k |
| 3V to 3.85V | Connect to BSTIN/BKLED ⁻ | 4.7 μ F 1206 X7R 10V | 2.2 μ F 1206 X7R 10V | 4V to 6V | 100mA | 1.30k | 86.6k | 250k | 37.4k | 500k |
| 3V to 5.6V | Connect to BSTIN/BKLED ⁻ | 4.7 μ F 1206 X7R 10V | 2.2 μ F 1206 X7R 10V | 6V to 9V | 100mA | 1.30k | 76.8k | 275k | 37.4k | 500k |
| 3V to 7V | Connect to BSTIN/BKLED ⁻ | 4.7 μ F 1206 X7R 10V | 2.2 μ F 1206 X7R 16V | 8V to 12V | 100mA | 1.30k | 69.8k | 300k | 37.4k | 500k |
| 3V to 10.2V | Connect to BSTIN/BKLED ⁻ | 4.7 μ F 1206 X7R 16V | 2.2 μ F 1206 X7R 16V | 12V to 16V | 100mA | 1.30k | 48.7k | 400k | 30.1k | 600k |
| 4V to 12.6V | Connect to BSTIN/BKLED ⁻ | 4.7 μ F 1206 X7R 16V | 2.2 μ F 1206 X7R 25V | 15V to 21V | 100mA | 1.30k | 37.4k | 500k | 30.1k | 600k |
| 4V to 14.5V | Connect to BSTIN/BKLED ⁻ | 2.2 μ F 1206 X7R 16V | 2.2 μ F 1206 X7R 25V | 18V to 24V | 100mA | 1.30k | 30.1k | 600k | 24.9k | 700k |
| 6.3V to 18.7V | Connect to BSTIN/BKLED ⁻ | 2.2 μ F 1206 X7R 25V | 2.2 μ F 1206 X7R 50V | 24V to 32V | 100mA | 1.30k | 24.9k | 700k | 21.0k | 800k |
| 3V to 3.8V | Connect to BSTIN/BKLED ⁻ | 1 μ F 0805 X7R 10V | 2.2 μ F 1206 X7R 10V | 4V to 6V | 350mA | 4.75k | 27.4k | 650k | 16.9k | 950k |
| 3V to 5.5V | Connect to BSTIN/BKLED ⁻ | 1 μ F 0805 X7R 10V | 2.2 μ F 1206 X7R 10V | 6V to 9V | 350mA | 4.75k | 27.4k | 650k | 16.9k | 950k |
| 3.3V to 7V | Connect to BSTIN/BKLED ⁻ | 1 μ F 0805 X7R 10V | 2.2 μ F 1206 X7R 16V | 8V to 12V | 350mA | 4.75k | 27.4k | 650k | 16.9k | 950k |
| 4.1V to 10V | Connect to BSTIN/BKLED ⁻ | 1 μ F 0805 X7R 10V | 2.2 μ F 1206 X7R 16V | 12V to 16V | 350mA | 4.75k | 19.6k | 850k | 15.8k | 1M |
| 5.5V to 12.5V | Connect to BSTIN/BKLED ⁻ | 1 μ F 1206 X7R 16V | 2.2 μ F 1206 X7R 25V | 15V to 21V | 350mA | 4.75k | 18.2k | 900k | 12.4k | 1.2M |
| 6.4V to 15V | Connect to BSTIN/BKLED ⁻ | 1 μ F 1206 X7R 16V | 2.2 μ F 1206 X7R 25V | 18V to 24V | 350mA | 4.75k | 16.9k | 950k | 14.0k | 1.1M |
| 9V to 20.8V | Connect to BSTIN/BKLED ⁻ | 2.2 μ F 1206 X7R 25V | 2.2 μ F 1206 X7R 50V | 24V to 32V | 350mA | 4.75k | 16.9k | 950k | 14.0k | 1.1M |
| 3V to 3.8V | Connect to BSTIN/BKLED ⁻ | 1 μ F 1206 X7R 10V | 2.2 μ F 1206 X7R 10V | 4V to 6V | 500mA | 7.32k | 27.4k | 650k | 16.9k | 950k |
| 3.3V to 5.7V | Connect to BSTIN/BKLED ⁻ | 1 μ F 1206 X7R 10V | 2.2 μ F 1206 X7R 10V | 6V to 9V | 500mA | 7.32k | 24.9k | 700k | 16.9k | 950k |
| 4V to 7.2V | Connect to BSTIN/BKLED ⁻ | 1 μ F 1206 X7R 10V | 2.2 μ F 1206 X7R 16V | 8V to 12V | 500mA | 7.32k | 24.9k | 700k | 16.9k | 950k |
| 5.2V to 10.4V | Connect to BSTIN/BKLED ⁻ | 2.2 μ F 1206 X7R 16V | 2.2 μ F 1206 X7R 16V | 12V to 16V | 500mA | 7.32k | 18.2k | 900k | 12.4k | 1.2M |
| 7V to 13V | Connect to BSTIN/BKLED ⁻ | 2.2 μ F 1206 X7R 16V | 4.7 μ F 1206 X7R 25V | 15V to 21V | 500mA | 7.32k | 18.2k | 900k | 14.0k | 1.1M |
| 8.2V to 15.5V | Connect to BSTIN/BKLED ⁻ | 2.2 μ F 1206 X7R 16V | 4.7 μ F 1206 X7R 25V | 18V to 24V | 500mA | 7.32k | 18.2k | 900k | 14.0k | 1.1M |
| 11.8V to 21.2V | Connect to BSTIN/BKLED ⁻ | 2.2 μ F 1206 X7R 25V | 4.7 μ F 1206 X7R 50V | 24V to 32V | 500mA | 7.32k | 16.9k | 950k | 15.8k | 1M |
| 3.3V to 3.5V | Connect to BSTIN/BKLED ⁻ | 1 μ F 1206 X7R 10V4 | 4.7 μ F 1206 X7R 10V | 4V to 6V | 700mA | 11.8k | 27.4k | 650k | 16.9k | 950k |
| 4V to 5.8V | Connect to BSTIN/BKLED ⁻ | 1 μ F 1206 X7R 10V | 4.7 μ F 1206 X7R 10V | 6V to 9V | 700mA | 11.8k | 24.9k | 700k | 21.0k | 800k |
| 5V to 7.6V | Connect to BSTIN/BKLED ⁻ | 1 μ F 1206 X7R 10V | 4.7 μ F 1206 X7R 16V | 8V to 12V | 700mA | 11.8k | 24.9k | 700k | 22.6k | 750k |
| 7V to 11V | Connect to BSTIN/BKLED ⁻ | 2.2 μ F 1206 X7R 16V | 4.7 μ F 1206 X7R 16V | 12V to 16V | 700mA | 11.8k | 18.2k | 900k | 16.9k | 950k |
| 9.5V to 13.5V | Connect to BSTIN/BKLED ⁻ | 2.2 μ F 1206 X7R 16V | 4.7 μ F 1206 X7R 25V | 15V to 21V | 700mA | 11.8k | 18.2k | 900k | 16.9k | 950k |
| 11V to 16V | Connect to BSTIN/BKLED ⁻ | 2.2 μ F 1206 X7R 16V | 4.7 μ F 1206 X7R 25V | 18V to 24V | 700mA | 11.8k | 18.2k | 900k | 16.9k | 950k |
| 16.5V to 21V | Connect to BSTIN/BKLED ⁻ | 2.2 μ F 1206 X7R 25V | 4.7 μ F 1206 X7R 50V | 24V to 32V | 700mA | 11.8k | 16.9k | 950k | 15.8k | 1M |
| 5V to 5.8V | Connect to BSTIN/BKLED ⁻ | 1 μ F 1206 X7R 10V | 4.7 μ F 1206 X7R 10V | 6V to 9V | 1A | Open | 30.1k | 600k | 22.6k | 750k |
| 6.4V to 7.7V | Connect to BSTIN/BKLED ⁻ | 1 μ F 1206 X7R 10V | 4.7 μ F 1206 X7R 16V | 8V to 12V | 1A | Open | 30.1k | 600k | 24.9k | 700k |
| 8.6V to 11.3V | Connect to BSTIN/BKLED ⁻ | 2.2 μ F 1206 X7R 16V | 4.7 μ F 1206 X7R 16V | 12V to 16V | 1A | Open | 24.9k | 700k | 22.6k | 750k |
| 11.3V to 13.8V | Connect to BSTIN/BKLED ⁻ | 2.2 μ F 1206 X7R 16V | 4.7 μ F 1206 X7R 25V | 15V to 21V | 1A | Open | 21.0k | 800k | 19.6k | 850k |
| 13.4V to 16.5V | Connect to BSTIN/BKLED ⁻ | 4.7 μ F 1206 X7R 25V | 4.7 μ F 1206 X7R 25V | 18V to 24V | 1A | Open | 27.4k | 650k | 24.9k | 700k |
| 20.5V to 22.5V | Connect to BSTIN/BKLED ⁻ | 4.7 μ F 1206 X7R 25V | 4.7 μ F 1206 X7R 50V | 24V to 32V | 1A | Open | 33.2k | 550k | 30.1k | 600k |

APPLICATIONS INFORMATION

Table 2. LTM8042 Recommended Values and Configuration for Buck Mode ($T_A = 25^\circ\text{C}$)

| V_{IN} RANGE (BSTOUT/BKIN) | V_{CC} | $C_{V_{CC}}$ | C_{IN} (BSTOUT/BKIN TO GND) | C_{OUT} (BSTOUT/BKIN TO BSTIN/BKLED ⁻) | LED STRING VOLTAGE (LED ⁺ TO BSTIN/ BKLED ⁻) | LED STRING CURRENT | R_{CTL} | RT (OPTI- MAL) | f (OPTI- MAL) | RT (MIN) | f (MAX) |
|---------------------------------|-----------|------------------------|-------------------------------------|--|---|--------------------------|-----------|----------------------|---------------------|-------------|------------|
| 4.4V to 5.5V | 3V to 30V | 1 μ F 0805 X7R 50V | 1 μ F 1206 X7R 50V | 2.2 μ F 1206 X7R 10V | 2V to 4V | 35mA | 523 | 86.6k | 250k | 86.6k | 250k |
| 6.8V to 14V | 3V to 30V | 1 μ F 0805 X7R 50V | 1 μ F 1206 X7R 50V | 2.2 μ F 1206 X7R 10V | 4V to 6V | 35mA | 523 | 86.6k | 250k | 86.6k | 250k |
| 9.6V to 26V | 3V to 30V | 1 μ F 0805 X7R 50V | 1 μ F 1206 X7R 50V | 2.2 μ F 1206 X7R 16V | 6V to 9V | 35mA | 523 | 86.6k | 250k | 86.6k | 250k |
| 12.5V to 33V | 3V to 30V | 1 μ F 0805 X7R 50V | 1 μ F 1206 X7R 50V | 2.2 μ F 1210 X7R 16V | 8V to 12V | 35mA | 523 | 86.6k | 250k | 86.6k | 250k |
| 16.6V to 33V | 3V to 30V | 1 μ F 0805 X7R 50V | 1 μ F 1206 X7R 50V | 2.2 μ F 1210 X7R 25V | 12V to 16V | 35mA | 523 | 86.6k | 250k | 46.4k | 420k |
| 21.8V to 33V | 3V to 30V | 1 μ F 0805 X7R 50V | 1 μ F 1206 X7R 50V | 2.2 μ F 1210 X7R 25V | 15V to 21V | 35mA | 523 | 86.6k | 250k | 33.2k | 550k |
| 24.5V to 33V | 3V to 30V | 1 μ F 0805 X7R 50V | 1 μ F 1206 X7R 50V | 2.2 μ F 1210 X7R 25V | 18V to 24V | 35mA | 523 | 86.6k | 250k | 26.1k | 670k |
| 4.5V to 21V | 3V to 30V | 1 μ F 0805 X7R 50V | 1 μ F 1206 X7R 50V | 4.7 μ F 1206 X7R 10V | 2V to 4V | 100mA | 1.30k | 86.6k | 250k | 86.6k | 250k |
| 6.8V to 33.8V | 3V to 30V | 1 μ F 0805 X7R 50V | 1 μ F 1206 X7R 50V | 4.7 μ F 1206 X7R 10V | 4V to 6V | 100mA | 1.30k | 86.6k | 250k | 86.6k | 250k |
| 9.9V to 33.5V | 3V to 30V | 1 μ F 0805 X7R 50V | 1 μ F 1206 X7R 50V | 4.7 μ F 1210 X7R 16V | 6V to 9V | 100mA | 1.30k | 76.8k | 275k | 69.8k | 300k |
| 13V to 33.4V | 3V to 30V | 1 μ F 0805 X7R 50V | 1 μ F 1206 X7R 50V | 4.7 μ F 1210 X7R 16V | 8V to 12V | 100mA | 1.30k | 69.8k | 300k | 48.7k | 400k |
| 17.2V to 33.1V | 3V to 30V | 1 μ F 0805 X7R 50V | 1 μ F 1206 X7R 50V | 4.7 μ F 1210 X7R 25V | 12V to 16V | 100mA | 1.30k | 37.4k | 500k | 31.6k | 575k |
| 23V to 33V | 3V to 30V | 1 μ F 0805 X7R 50V | 1 μ F 1206 X7R 50V | 4.7 μ F 1210 X7R 25V | 15V to 21V | 100mA | 1.30k | 24.9k | 700k | 19.1k | 870k |
| 26V to 33V | 3V to 30V | 1 μ F 0805 X7R 50V | 1 μ F 1206 X7R 50V | 4.7 μ F 1210 X7R 25V | 18V to 24V | 100mA | 1.30k | 21.0k | 800k | 12.4k | 1.2M |
| 5.2V to 33.6V | 3V to 30V | 1 μ F 0805 X7R 50V | 1 μ F 1206 X7R 50V | 4.7 μ F 1206 X7R 10V | 2V to 4V | 350mA | 4.75k | 61.9k | 330k | 54.9k | 365k |
| 7V to 33.4V | 3V to 30V | 1 μ F 0805 X7R 50V | 1 μ F 1206 X7R 50V | 4.7 μ F 1206 X7R 10V | 4V to 6V | 350mA | 4.75k | 30.1k | 600k | 24.9k | 700k |
| 10.5V to 33.3V | 3V to 30V | 1 μ F 0805 X7R 50V | 1 μ F 1206 X7R 50V | 4.7 μ F 1210 X7R 16V | 6V to 9V | 350mA | 4.75k | 21.0k | 800k | 15.8k | 1M |
| 14.5V to 33.2V | 3V to 30V | 1 μ F 0805 X7R 50V | 1 μ F 1206 X7R 50V | 4.7 μ F 1210 X7R 16V | 8V to 12V | 350mA | 4.75k | 12.4k | 1.2M | 8.25k | 1.6M |
| 19.2V to 33V | 3V to 30V | 1 μ F 0805 X7R 50V | 1 μ F 1206 X7R 50V | 4.7 μ F 1210 X7R 25V | 12V to 16V | 350mA | 4.75k | 11.0k | 1.3M | 3.74k | 2.5M |
| 25V to 33V | 3V to 30V | 1 μ F 0805 X7R 50V | 1 μ F 1206 X7R 50V | 4.7 μ F 1210 X7R 25V | 15V to 21V | 350mA | 4.75k | 11.0k | 1.3M | 3.74k | 2.5M |
| 4.9V to 33V | 3V to 30V | 1 μ F 0805 X7R 50V | 1 μ F 1206 X7R 50V | 4.7 μ F 1206 X7R 10V | 2V to 4V | 500mA | 7.32k | 37.4k | 500k | 33.2k | 550k |
| 7.3V to 33.2V | 3V to 30V | 1 μ F 0805 X7R 50V | 1 μ F 1206 X7R 50V | 4.7 μ F 1206 X7R 10V | 4V to 6V | 500mA | 7.32k | 21.0k | 800k | 18.2k | 900k |
| 10.7V to 33V | 3V to 30V | 1 μ F 0805 X7R 50V | 1 μ F 1206 X7R 50V | 4.7 μ F 1210 X7R 16V | 6V to 9V | 500mA | 7.32k | 15.8k | 1M | 11.0k | 1.3M |
| 14.1V to 32.8V | 3V to 30V | 1 μ F 0805 X7R 50V | 1 μ F 1206 X7R 50V | 4.7 μ F 1210 X7R 16V | 8V to 12V | 500mA | 7.32k | 15.8k | 1M | 7.50k | 1.7M |
| 18.5V to 32.5V | 3V to 30V | 1 μ F 0805 X7R 50V | 1 μ F 1206 X7R 50V | 4.7 μ F 1210 X7R 25V | 12V to 16V | 500mA | 7.32k | 15.8k | 1M | 3.74k | 2.5M |
| 24.3V to 32.5V | 3V to 30V | 1 μ F 0805 X7R 50V | 1 μ F 1206 X7R 50V | 4.7 μ F 1210 X7R 25V | 15V to 21V | 500mA | 7.32k | 15.8k | 1M | 3.74k | 2.5M |
| 5V to 33.2V | 3V to 30V | 1 μ F 0805 X7R 50V | 1 μ F 1206 X7R 50V | 4.7 μ F 1206 X7R 10V | 2V to 4V | 700mA | 11.8k | 33.2k | 550k | 30.1k | 600k |
| 7.3V to 32.7V | 3V to 30V | 1 μ F 0805 X7R 50V | 1 μ F 1206 X7R 50V | 4.7 μ F 1206 X7R 10V | 4V to 6V | 700mA | 11.8k | 21.0k | 800k | 18.2k | 900k |
| 10.8V to 32.7V | 3V to 30V | 1 μ F 0805 X7R 50V | 1 μ F 1206 X7R 50V | 4.7 μ F 1210 X7R 16V | 6V to 9V | 700mA | 11.8k | 15.8k | 1M | 11.0k | 1.3M |
| 14.4V to 32.2V | 3V to 30V | 1 μ F 0805 X7R 50V | 1 μ F 1206 X7R 50V | 4.7 μ F 1210 X7R 16V | 8V to 12V | 700mA | 11.8k | 15.8k | 1M | 7.50k | 1.7M |
| 18.8V to 31.7V | 3V to 30V | 1 μ F 0805 X7R 50V | 1 μ F 1206 X7R 50V | 4.7 μ F 1210 X7R 25V | 12V to 16V | 700mA | 11.8k | 15.8k | 1M | 3.74k | 2.5M |
| 24.3V to 31.8V | 3V to 30V | 1 μ F 0805 X7R 50V | 1 μ F 1206 X7R 50V | 4.7 μ F 1210 X7R 25V | 15V to 21V | 700mA | 11.8k | 15.8k | 1M | 3.74k | 2.5M |
| 5V to 32V | 3V to 30V | 1 μ F 0805 X7R 50V | 2.2 μ F 1206 X7R 50V | 4.7 μ F 1206 X7R 10V | 2V to 4V | 1A | Open | 33.2k | 550k | 30.1k | 600k |
| 7.2V to 32V | 3V to 30V | 1 μ F 0805 X7R 50V | 2.2 μ F 1206 X7R 50V | 4.7 μ F 1206 X7R 10V | 4V to 6V | 1A | Open | 21.0k | 800k | 16.9k | 950k |
| 10.8V to 31V | 3V to 30V | 1 μ F 0805 X7R 50V | 2.2 μ F 1206 X7R 50V | 4.7 μ F 1210 X7R 16V | 6V to 9V | 1A | Open | 15.8k | 1M | 11.0k | 1.3M |
| 14.3V to 30.5V | 3V to 30V | 1 μ F 0805 X7R 50V | 2.2 μ F 1206 X7R 50V | 4.7 μ F 1210 X7R 16V | 8V to 12V | 1A | Open | 15.8k | 1M | 7.50k | 1.7M |
| 18.9V to 30.5V | 3V to 30V | 1 μ F 0805 X7R 50V | 2.2 μ F 1206 X7R 50V | 4.7 μ F 1210 X7R 25V | 12V to 16V | 1A | Open | 15.8k | 1M | 3.74k | 2.5M |
| 24.6V to 30.5V | 3V to 30V | 1 μ F 0805 X7R 50V | 2.2 μ F 1206 X7R 50V | 4.7 μ F 1210 X7R 25V | 15V to 21V | 1A | Open | 15.8k | 1M | 3.74k | 2.5M |

APPLICATIONS INFORMATION

Table 3. LTM8042 Recommended Values and Configuration for Buck-Boost Mode ($T_A = 25^\circ\text{C}$)

| V_{IN} RANGE (BSTIN/ BKLED ⁻) | V_{CC} | $C_{V_{CC}}$ (V_{CC} to GND) | C_{IN} (BSTIN/BKLED ⁻ TO GND) | C_{OUT1} (BSTOUT/BKIN TO BSTIN/ BKLED ⁻) | C_{OUT2} (BSTOUT/BKIN TO GND) | LED STRING VOLTAGE (LED ⁺ to BSTIN/ BKLED ⁻) | LED STRING CURR- ENT | R_{CTL} | RT (OPTI- MAL) | f (OPTI- MAL) | RT (MIN) | f (MAX) |
|--|-----------|------------------------------------|--|---|---------------------------------------|--|-------------------------------|-----------|----------------------|---------------------|-------------|------------|
| 3V to 6V | 3V to 30V | 1 μ F 0805 X7R 50V | 1 μ F 0805 X7R 10V | 1 μ F 0805 X7R 10V | 1 μ F 0805 X7R 10V | 2V to 4V | 35mA | 523 | 86.6k | 250k | 86.6k | 250k |
| 3V to 14V | 3V to 30V | 1 μ F 0805 X7R 50V | 1 μ F 0805 X7R 16V | 1 μ F 0805 X7R 10V | 1 μ F 0805 X7R 10V | 4V to 6V | 35mA | 523 | 86.6k | 250k | 86.6k | 250k |
| 3V to 20V | 3V to 30V | 1 μ F 0805 X7R 50V | 1 μ F 1206 X7R 25V | 1 μ F 0805 X7R 10V | 1 μ F 0805 X7R 10V | 6V to 9V | 35mA | 523 | 86.6k | 250k | 86.6k | 250k |
| 3V to 21V | 3V to 30V | 1 μ F 0805 X7R 50V | 1 μ F 1206 X7R 25V | 1 μ F 0805 X7R 16V | 1 μ F 0805 X7R 16V | 8V to 12V | 35mA | 523 | 86.6k | 250k | 57.6k | 350k |
| 3V to 17.8V | 3V to 30V | 1 μ F 0805 X7R 50V | 1 μ F 1206 X7R 25V | 1 μ F 0805 X7R 16V | 1 μ F 1206 X7R 25V | 12V to 16V | 35mA | 523 | 48.7k | 400k | 27.4k | 650k |
| 3V to 13V | 3V to 30V | 1 μ F 0805 X7R 50V | 1 μ F 0805 X7R 16V | 1 μ F 1206 X7R 25V | 1 μ F 1206 X7R 25V | 15V to 21V | 35mA | 523 | 37.4k | 500k | 10.0k | 1.4M |
| 3.5V to 10.1V | 3V to 30V | 1 μ F 0805 X7R 50V | 1 μ F 0805 X7R 16V | 1 μ F 1206 X7R 25V | 1 μ F 1206 X7R 25V | 18V to 24V | 35mA | 523 | 22.6k | 750k | 3.74k | 2.5M |
| 3V to 21V | 3V to 30V | 1 μ F 0805 X7R 50V | 1 μ F 1206 X7R 25V | 2.2 μ F 1206 X7R 10V | 1 μ F 0805 X7R 10V | 2V to 4V | 100mA | 1.30k | 86.6k | 250k | 69.8k | 300k |
| 3V to 22.8V | 3V to 30V | 1 μ F 0805 X7R 50V | 1 μ F 1206 X7R 25V | 1 μ F 0805 X7R 10V | 1 μ F 0805 X7R 10V | 4V to 6V | 100mA | 1.30k | 48.7k | 400k | 43.2k | 450k |
| 3V to 23.4V | 3V to 30V | 1 μ F 0805 X7R 50V | 1 μ F 1206 X7R 25V | 1 μ F 0805 X7R 10V | 1 μ F 0805 X7R 10V | 6V to 9V | 100mA | 1.30k | 37.4k | 500k | 30.1k | 600k |
| 3V to 21.8V | 3V to 30V | 1 μ F 0805 X7R 50V | 1 μ F 1206 X7R 25V | 1 μ F 0805 X7R 16V | 1 μ F 1206 X7R 25V | 8V to 12V | 100mA | 1.30k | 21.0k | 800k | 16.9k | 950k |
| 3V to 17.9V | 3V to 30V | 1 μ F 0805 X7R 50V | 1 μ F 1206 X7R 25V | 1 μ F 0805 X7R 16V | 1 μ F 1206 X7R 25V | 12V to 16V | 100mA | 1.30k | 19.6k | 850k | 11.0k | 1.3M |
| 3V to 12.6V | 3V to 30V | 1 μ F 0805 X7R 50V | 1 μ F 0805 X7R 16V | 1 μ F 1206 X7R 25V | 1 μ F 1206 X7R 25V | 15V to 21V | 100mA | 1.30k | 19.6k | 850k | 4.02k | 2.4M |
| 3.7V to 9.7V | 3V to 30V | 1 μ F 0805 X7R 50V | 1 μ F 0805 X7R 10V | 1 μ F 1206 X7R 25V | 1 μ F 1206 X7R 25V | 18V to 24V | 100mA | 1.30k | 19.6k | 850k | 3.74k | 2.5M |
| 3V to 28V | 3V to 30V | 1 μ F 0805 X7R 50V | 1 μ F 1206 X7R 50V | 2.2 μ F 1206 X7R 10V | 1 μ F 0805 X7R 10V | 2V to 4V | 350mA | 4.75k | 43.2k | 450k | 37.4k | 500k |
| 3V to 27.5V | 3V to 30V | 1 μ F 0805 X7R 50V | 1 μ F 1206 X7R 50V | 2.2 μ F 1206 X7R 10V | 1 μ F 0805 X7R 10V | 4V to 6V | 350mA | 4.75k | 33.2k | 550k | 24.9k | 700k |
| 4.5V to 24.5V | 3V to 30V | 1 μ F 0805 X7R 50V | 1 μ F 1206 X7R 25V | 2.2 μ F 1206 X7R 10V | 1 μ F 0805 X7R 10V | 6V to 9V | 350mA | 4.75k | 24.9k | 700k | 10.7k | 1.35M |
| 5.5V to 20.7V | 3V to 30V | 1 μ F 0805 X7R 50V | 1 μ F 1206 X7R 25V | 2.2 μ F 1206 X7R 16V | 1 μ F 1206 X7R 25V | 8V to 12V | 350mA | 4.75k | 15.8k | 1M | 6.19k | 1.9M |
| 7V to 17.1V | 3V to 30V | 1 μ F 0805 X7R 50V | 1 μ F 1206 X7R 25V | 2.2 μ F 1206 X7R 16V | 1 μ F 1206 X7R 25V | 12V to 16V | 350mA | 4.75k | 15.8k | 1M | 3.74k | 2.5M |
| 8.2V to 11.4V | 3V to 30V | 1 μ F 0805 X7R 50V | 1 μ F 0805 X7R 16V | 4.7 μ F 1210 X7R 25V | 1 μ F 1206 X7R 25V | 15V to 21V | 350mA | 4.75k | 18.2k | 900k | 3.74k | 2.5M |
| 3V to 23V | 3V to 30V | 1 μ F 0805 X7R 50V | 1 μ F 1206 X7R 25V | 2.2 μ F 1206 X7R 10V | 1 μ F 0805 X7R 10V | 2V to 4V | 500mA | 7.32k | 27.4k | 650k | 24.9k | 700k |
| 4.5V to 27V | 3V to 30V | 1 μ F 0805 X7R 50V | 1 μ F 1206 X7R 50V | 2.2 μ F 1206 X7R 10V | 1 μ F 0805 X7R 10V | 4V to 6V | 500mA | 7.32k | 21.0k | 800k | 19.6k | 850k |
| 6V to 24V | 3V to 30V | 1 μ F 0805 X7R 50V | 1 μ F 1206 X7R 25V | 2.2 μ F 1206 X7R 10V | 1 μ F 0805 X7R 10V | 6V to 9V | 500mA | 7.32k | 15.8k | 1M | 10.0k | 1.4M |
| 7.3V to 20.3V | 3V to 30V | 1 μ F 0805 X7R 50V | 1 μ F 1206 X7R 25V | 2.2 μ F 1206 X7R 16V | 1 μ F 1206 X7R 25V | 8V to 12V | 500mA | 7.32k | 15.8k | 1M | 6.34k | 1.85M |
| 9.4V to 15V | 3V to 30V | 1 μ F 0805 X7R 50V | 1 μ F 0805 X7R 16V | 2.2 μ F 1206 X7R 16V | 1 μ F 1206 X7R 25V | 12V to 16V | 500mA | 7.32k | 15.8k | 1M | 3.74k | 2.5M |
| 4.2V to 23.8V | 3V to 30V | 1 μ F 0805 X7R 50V | 2.2 μ F 1206 X7R 25V | 2.2 μ F 1206 X7R 10V | 1 μ F 0805 X7R 10V | 2V to 4V | 700mA | 11.8k | 24.9k | 700k | 22.6k | 750k |
| 4.7V to 27V | 3V to 30V | 1 μ F 0805 X7R 50V | 2.2 μ F 1206 X7R 50V | 2.2 μ F 1206 X7R 10V | 1 μ F 0805 X7R 10V | 4V to 6V | 700mA | 11.8k | 16.9k | 950k | 15.8k | 1M |
| 6.1V to 23V | 3V to 30V | 1 μ F 0805 X7R 50V | 2.2 μ F 1206 X7R 25V | 2.2 μ F 1206 X7R 10V | 1 μ F 0805 X7R 10V | 6V to 9V | 700mA | 11.8k | 16.9k | 950k | 9.09k | 1.5M |
| 7.3V to 20V | 3V to 30V | 1 μ F 0805 X7R 50V | 2.2 μ F 1206 X7R 25V | 2.2 μ F 1206 X7R 16V | 1 μ F 1206 X7R 25V | 8V to 12V | 700mA | 11.8k | 16.9k | 950k | 6.19k | 1.9M |
| 10.5V to 16.5V | 3V to 30V | 1 μ F 0805 X7R 50V | 2.2 μ F 1206 X7R 25V | 4.7 μ F 1210 X7R 16V | 1 μ F 1206 X7R 25V | 12V to 16V | 700mA | 11.8k | 15.8k | 1M | 3.74k | 2.5M |
| 4.7V to 28.5V | 3V to 30V | 1 μ F 0805 X7R 50V | 2.2 μ F 1206 X7R 50V | 4.7 μ F 1206 X7R 10V | 1 μ F 0805 X7R 10V | 2V to 4V | 1A | Open | 24.9k | 700k | 22.6k | 750k |
| 6.7V to 26.8V | 3V to 30V | 1 μ F 0805 X7R 50V | 2.2 μ F 1206 X7R 50V | 4.7 μ F 1206 X7R 10V | 1 μ F 0805 X7R 10V | 4V to 6V | 1A | Open | 22.6k | 750k | 16.9k | 950k |
| 9V to 23.5V | 3V to 30V | 1 μ F 0805 X7R 50V | 4.7 μ F 1210 X7R 25V | 4.7 μ F 1206 X7R 10V | 1 μ F 0805 X7R 10V | 6V to 9V | 1A | Open | 22.6k | 750k | 10.0k | 1.4M |
| 13.5V to 20V | 3V to 30V | 1 μ F 0805 X7R 50V | 4.7 μ F 1210 X7R 25V | 4.7 μ F 1210 X7R 16V | 1 μ F 1206 X7R 25V | 8V to 12V | 1A | Open | 22.6k | 750k | 5.76k | 2M |

APPLICATIONS INFORMATION

Table 4. LTM8042-1 Recommended Values and Configuration for Boost ($T_A = 25^\circ\text{C}$)

| V_{IN} RANGE (BSTIN/ BKLED ⁻) | V_{CC} | C_{IN} (BSTIN/BKLED ⁻ TO GND) | C_{OUT} (BSTOUT/BKIN TO GND) | LED STRING VOLTAGE (LED ⁺ TO GND) | LED STRING CURRENT | R_{CTL} | RT (OPTI- MAL) | f (OPTI- MAL) | RT (MIN) | f (MAX) |
|--|-------------------------------------|--|--------------------------------------|--|--------------------------|-----------|----------------------|---------------------|-------------|------------|
| 1V to 3.3V | 3V to 30V | 1 μ F 0805 X7R 10V | 1 μ F 0805 X7R 10V | 4V to 6V | 35mA | 1.27k | 86.6k | 250k | 69.8k | 300k |
| 1.2V to 5V | 3V to 30V | 1 μ F 0805 X7R 10V | 1 μ F 0805 X7R 10V | 6V to 9V | 35mA | 1.27k | 76.8k | 275k | 61.9k | 330k |
| 1.6V to 6V | 3V to 30V | 1 μ F 0805 X7R 10V | 1 μ F 0805 X7R 16V | 8V to 12V | 35mA | 1.27k | 69.8k | 300k | 57.6k | 350k |
| 2.2V to 9.2V | 3V to 30V | 1 μ F 0805 X7R 10V | 1 μ F 0805 X7R 16V | 12V to 16V | 35mA | 1.27k | 48.7k | 400k | 37.4k | 500k |
| 2.7V to 10V | 3V to 30V | 1 μ F 0805 X7R 16V | 1 μ F 0805 X7R 25V | 15V to 21V | 35mA | 1.27k | 37.4k | 500k | 30.1k | 600k |
| 3V to 12.8V | Connect to BSTIN/BKLED ⁻ | 1 μ F 0805 X7R 16V | 1 μ F 0805 X7R 25V | 18V to 24V | 35mA | 1.27k | 33.2k | 550k | 27.4k | 650k |
| 3.7V to 14.7V | Connect to BSTIN/BKLED ⁻ | 1 μ F 0805 X7R 16V | 1 μ F 0805 X7R 50V | 24V to 32V | 35mA | 1.27k | 33.2k | 550k | 27.4k | 650k |
| 1.1V to 3.8V | 3V to 30V | 1 μ F 0805 X7R 10V | 2.2 μ F 1206 X7R 10V | 4V to 6V | 100mA | 3.40k | 86.6k | 250k | 37.4k | 500k |
| 1.5V to 5.6V | 3V to 30V | 1 μ F 0805 X7R 16V | 2.2 μ F 1206 X7R 10V | 6V to 9V | 100mA | 3.40k | 76.8k | 275k | 37.4k | 500k |
| 2.4V to 7.1V | 3V to 30V | 2.2 μ F 1206 X7R 10V | 2.2 μ F 1206 X7R 16V | 8V to 12V | 100mA | 3.40k | 69.8k | 300k | 37.4k | 500k |
| 3.1V to 10.4V | Connect to BSTIN/BKLED ⁻ | 2.2 μ F 1206 X7R 16V | 2.2 μ F 1206 X7R 16V | 12V to 16V | 100mA | 3.40k | 48.7k | 400k | 30.1k | 600k |
| 4V to 12V | Connect to BSTIN/BKLED ⁻ | 2.2 μ F 1206 X7R 16V | 2.2 μ F 1206 X7R 25V | 15V to 21V | 100mA | 3.40k | 37.4k | 500k | 30.1k | 600k |
| 4.9V to 14.9V | Connect to BSTIN/BKLED ⁻ | 1 μ F 0805 X7R 16V | 2.2 μ F 1206 X7R 25V | 18V to 24V | 100mA | 3.40k | 30.1k | 600k | 24.9k | 700k |
| 6.1V to 18.8V | Connect to BSTIN/BKLED ⁻ | 1 μ F 0805 X7R 25V | 2.2 μ F 1206 X7R 50V | 24V to 32V | 100mA | 3.40k | 24.9k | 700k | 21.0k | 800k |
| 2.4V to 3.8V | 3V to 30V | 1 μ F 0805 X7R 10V | 4.7 μ F 0805 X7R 10V | 4V to 6V | 350mA | 19.6k | 27.4k | 650k | 16.9k | 950k |
| 2.8V to 5.3V | 3V to 30V | 1 μ F 0805 X7R 10V | 2.2 μ F 1206 X7R 10V | 6V to 9V | 350mA | 19.6k | 27.4k | 650k | 16.9k | 950k |
| 3.2V to 7V | Connect to BSTIN/BKLED ⁻ | 1 μ F 0805 X7R 10V | 2.2 μ F 1206 X7R 16V | 8V to 12V | 350mA | 19.6k | 27.4k | 650k | 16.9k | 950k |
| 4.1V to 10V | Connect to BSTIN/BKLED ⁻ | 1 μ F 1206 X7R 10V | 2.2 μ F 1206 X7R 16V | 12V to 16V | 350mA | 19.6k | 19.6k | 850k | 15.8k | 1M |
| 4.8V to 12.3V | Connect to BSTIN/BKLED ⁻ | 1 μ F 1206 X7R 16V | 2.2 μ F 1206 X7R 25V | 15V to 21V | 350mA | 19.6k | 18.2k | 900k | 12.4k | 1.2M |
| 5.8V to 15V | Connect to BSTIN/BKLED ⁻ | 1 μ F 1206 X7R 16V | 2.2 μ F 1206 X7R 25V | 18V to 24V | 350mA | 19.6k | 16.9k | 950k | 14.0k | 1.1M |
| 8.5V to 20.8V | Connect to BSTIN/BKLED ⁻ | 2.2 μ F 1206 X7R 25V | 2.2 μ F 1206 X7R 50V | 24V to 32V | 350mA | 19.6k | 16.9k | 950k | 14.0k | 1.1M |

APPLICATIONS INFORMATION

Table 5. LTM8042-1 Recommended Values and Configuration for Buck Mode ($T_A = 25^\circ\text{C}$)

| V_{IN} RANGE (BSTOUT/ BKIN) | V_{CC} | C_{VCC} | C_{IN} (BSTOUT/BKIN TO GND) | C_{OUT} (BSTOUT/BKIN TO BSTIN/BKLED ⁻) | LED STRING VOLTAGE (LED ⁺ TO BSTIN/ BKLED ⁻) | LED STRING CURRENT | R_{CTL} | R (OPTI- MAL) | f (OPTI- MAL) | R_T (MIN) | f (MAX) |
|-------------------------------------|-----------|------------------------|-------------------------------------|--|--|--------------------------|-----------|---------------------|---------------------|----------------|------------|
| 4.3V to 8.3V | 3V to 30V | 1 μ F 0805 X7R 50V | 1 μ F 1206 X7R 50V | 2.2 μ F 1206 X7R 10V | 2V to 4V | 35mA | 1.27k | 86.6k | 250k | 86.6k | 250k |
| 6.6V to 20V | 3V to 30V | 1 μ F 0805 X7R 50V | 1 μ F 1206 X7R 50V | 2.2 μ F 1206 X7R 10V | 4V to 6V | 35mA | 1.27k | 86.6k | 250k | 86.6k | 250k |
| 9.5V to 31.5V | 3V to 30V | 1 μ F 0805 X7R 50V | 1 μ F 1206 X7R 50V | 2.2 μ F 1206 X7R 16V | 6V to 9V | 35mA | 1.27k | 86.6k | 250k | 86.6k | 250k |
| 12.5V to 33V | 3V to 30V | 1 μ F 0805 X7R 50V | 1 μ F 1206 X7R 50V | 2.2 μ F 1210 X7R 16V | 8V to 12V | 35mA | 1.27k | 86.6k | 250k | 86.6k | 250k |
| 16.6V to 33.2V | 3V to 30V | 1 μ F 0805 X7R 50V | 1 μ F 1206 X7R 50V | 2.2 μ F 1210 X7R 25V | 12V to 16V | 35mA | 1.27k | 86.6k | 250k | 46.4k | 420k |
| 21.8V to 33.6V | 3V to 30V | 1 μ F 0805 X7R 50V | 1 μ F 1206 X7R 50V | 2.2 μ F 1210 X7R 25V | 15V to 21V | 35mA | 1.27k | 86.6k | 250k | 33.2k | 550k |
| 24.4V to 33.1V | 3V to 30V | 1 μ F 0805 X7R 50V | 1 μ F 1206 X7R 50V | 2.2 μ F 1210 X7R 25V | 18V to 24V | 35mA | 1.27k | 86.6k | 250k | 26.1k | 670k |
| 4.3V to 19.5V | 3V to 30V | 1 μ F 0805 X7R 50V | 1 μ F 1206 X7R 50V | 4.7 μ F 1206 X7R 10V | 2V to 4V | 100mA | 3.40k | 86.6k | 250k | 86.6k | 250k |
| 6.5V to 33.8V | 3V to 30V | 1 μ F 0805 X7R 50V | 1 μ F 1206 X7R 50V | 4.7 μ F 1206 X7R 10V | 4V to 6V | 100mA | 3.40k | 86.6k | 250k | 86.6k | 250k |
| 9.6V to 34.5V | 3V to 30V | 1 μ F 0805 X7R 50V | 1 μ F 1206 X7R 50V | 4.7 μ F 1210 X7R 16V | 6V to 9V | 100mA | 3.40k | 76.8k | 275k | 57.6k | 350k |
| 12.6V to 34.4V | 3V to 30V | 1 μ F 0805 X7R 50V | 1 μ F 1206 X7R 50V | 4.7 μ F 1210 X7R 16V | 8V to 12V | 100mA | 3.40k | 69.8k | 300k | 48.7k | 400k |
| 17V to 34.5V | 3V to 30V | 1 μ F 0805 X7R 50V | 1 μ F 1206 X7R 50V | 4.7 μ F 1210 X7R 25V | 12V to 16V | 100mA | 3.40k | 37.4k | 500k | 31.6k | 575k |
| 22.8V to 34.5V | 3V to 30V | 1 μ F 0805 X7R 50V | 1 μ F 1206 X7R 50V | 4.7 μ F 1210 X7R 25V | 15V to 21V | 100mA | 3.40k | 24.9k | 700k | 19.1k | 870k |
| 26.2V to 34.4V | 3V to 30V | 1 μ F 0805 X7R 50V | 1 μ F 1206 X7R 50V | 4.7 μ F 1210 X7R 25V | 18V to 24V | 100mA | 3.40k | 21.0k | 800k | 12.4k | 1.2M |
| 4.6V to 34.3V | 3V to 30V | 1 μ F 0805 X7R 50V | 1 μ F 1206 X7R 50V | 4.7 μ F 1206 X7R 10V | 2V to 4V | 350mA | 19.6k | 61.9k | 330k | 54.9k | 365k |
| 6.7V to 34.3V | 3V to 30V | 1 μ F 0805 X7R 50V | 1 μ F 1206 X7R 50V | 4.7 μ F 1206 X7R 10V | 4V to 6V | 350mA | 19.6k | 30.1k | 600k | 24.9k | 700k |
| 10.3V to 34.3V | 3V to 30V | 1 μ F 0805 X7R 50V | 1 μ F 1206 X7R 50V | 4.7 μ F 1210 X7R 16V | 6V to 9V | 350mA | 19.6k | 21.0k | 800k | 15.8k | 1M |
| 13.7V to 34.5V | 3V to 30V | 1 μ F 0805 X7R 50V | 1 μ F 1206 X7R 50V | 4.7 μ F 1210 X7R 16V | 8V to 12V | 350mA | 19.6k | 19.6k | 850k | 8.25k | 1.6M |
| 18.6V to 34.6V | 3V to 30V | 1 μ F 0805 X7R 50V | 1 μ F 1206 X7R 50V | 4.7 μ F 1210 X7R 25V | 12V to 16V | 350mA | 19.6k | 14.0k | 1.1M | 3.74k | 2.5M |
| 24.1V to 34.3V | 3V to 30V | 1 μ F 0805 X7R 50V | 1 μ F 1206 X7R 50V | 4.7 μ F 1210 X7R 25V | 15V to 21V | 350mA | 19.6k | 15.8k | 1M | 3.74k | 2.5M |
| 27.3V to 32.8V | 3V to 30V | 1 μ F 0805 X7R 50V | 1 μ F 1206 X7R 50V | 4.7 μ F 1210 X7R 25V | 18V to 24V | 350mA | 19.6k | 15.8k | 1M | 3.74k | 2.5M |

APPLICATIONS INFORMATION

Table 6. LTM8042-1 Recommended Values and Configuration for Buck-Boost Mode ($T_A = 25^\circ\text{C}$)

| V_{IN} RANGE (BSTIN/ BKLED ⁻) | V_{CC} | $C_{V_{CC}}$ (V_{CC} TO GND) | C_{IN} (BSTIN/BKLED ⁻ TO GND) | C_{OUT1} (BSTOUT/BKIN TO BSTIN/ BKLED ⁻) | C_{OUT2} (BSTOUT/BKIN TO GND) | LED STRING VOLTAGE (LED ⁺ TO BSTIN/ BKLED ⁻) | LED STRING CUR- RENT | R_{CTL} | RT (OPTI- MAL) | f (OPTI- MAL) | RT (MIN) | f (MAX) |
|---|-----------|------------------------------------|--|---|---------------------------------------|--|-------------------------------|-----------|----------------------|---------------------|-------------|------------|
| 1V to 9.5V | 3V to 30V | 1 μ F 0805 X7R 50V | 1 μ F 0805 X7R 10V | 1 μ F 0805 X7R 10V | 1 μ F 0805 X7R 10V | 2V to 4V | 35mA | 1.27k | 86.6k | 250k | 86.6k | 250k |
| 1.1V to 21V | 3V to 30V | 1 μ F 0805 X7R 50V | 1 μ F 0805 X7R 16V | 1 μ F 0805 X7R 10V | 1 μ F 0805 X7R 10V | 4V to 6V | 35mA | 1.27k | 86.6k | 250k | 86.6k | 250k |
| 1.3V to 24V | 3V to 30V | 1 μ F 0805 X7R 50V | 1 μ F 1206 X7R 25V | 1 μ F 0805 X7R 10V | 1 μ F 0805 X7R 10V | 6V to 9V | 35mA | 1.27k | 86.6k | 250k | 86.6k | 250k |
| 1.5V to 20.8V | 3V to 30V | 1 μ F 0805 X7R 50V | 1 μ F 1206 X7R 25V | 1 μ F 0805 X7R 16V | 1 μ F 0805 X7R 16V | 8V to 12V | 35mA | 1.27k | 86.6k | 250k | 43.2k | 450k |
| 2.2V to 16.9V | 3V to 30V | 1 μ F 0805 X7R 50V | 1 μ F 1206 X7R 25V | 1 μ F 0805 X7R 16V | 1 μ F 1206 X7R 25V | 12V to 16V | 35mA | 1.27k | 48.7k | 400k | 30.1k | 600k |
| 3V to 12V | 3V to 30V | 1 μ F 0805 X7R 50V | 1 μ F 1206 X7R 25V | 1 μ F 1206 X7R 25V | 1 μ F 1206 X7R 25V | 15V to 21V | 35mA | 1.27k | 37.4k | 500k | 10.0k | 1.4M |
| 3.8V to 9V | 3V to 30V | 1 μ F 0805 X7R 50V | 1 μ F 1206 X7R 25V | 1 μ F 1206 X7R 25V | 1 μ F 1206 X7R 25V | 18V to 24V | 35mA | 1.27k | 22.6k | 750k | 3.74k | 2.5M |
| 1.1V to 24V | 3V to 30V | 1 μ F 0805 X7R 50V | 1 μ F 1206 X7R 25V | 2.2 μ F 1206 X7R 10V | 1 μ F 0805 X7R 10V | 2V to 4V | 100mA | 3.40k | 86.6k | 250k | 69.8k | 300k |
| 1.3V to 27V | 3V to 30V | 1 μ F 0805 X7R 50V | 1 μ F 1206 X7R 25V | 1 μ F 0805 X7R 10V | 1 μ F 0805 X7R 10V | 4V to 6V | 100mA | 3.40k | 48.7k | 400k | 43.2k | 450k |
| 1.6V to 24V | 3V to 30V | 1 μ F 0805 X7R 50V | 1 μ F 1206 X7R 25V | 1 μ F 0805 X7R 10V | 1 μ F 0805 X7R 10V | 6V to 9V | 100mA | 3.40k | 37.4k | 500k | 33.2k | 550k |
| 1.9V to 21.5V | 3V to 30V | 1 μ F 0805 X7R 50V | 1 μ F 1206 X7R 25V | 1 μ F 0805 X7R 16V | 1 μ F 0805 X7R 16V | 8V to 12V | 100mA | 3.40k | 21.0k | 800k | 19.6k | 850k |
| 2.5V to 17V | 3V to 30V | 1 μ F 0805 X7R 50V | 1 μ F 1206 X7R 25V | 1 μ F 0805 X7R 16V | 1 μ F 1206 X7R 25V | 12V to 16V | 100mA | 3.40k | 19.6k | 850k | 8.25k | 1.6M |
| 3V to 12V | 3V to 30V | 1 μ F 0805 X7R 50V | 1 μ F 0805 X7R 16V | 1 μ F 1206 X7R 25V | 1 μ F 1206 X7R 25V | 15V to 21V | 100mA | 3.40k | 19.6k | 850k | 3.74k | 2.5M |
| 3.7V to 9V | 3V to 30V | 1 μ F 0805 X7R 50V | 1 μ F 0805 X7R 10V | 1 μ F 1206 X7R 25V | 1 μ F 1206 X7R 25V | 18V to 24V | 100mA | 3.40k | 15.8k | 1M | 3.74k | 2.5M |
| 2.2V to 29V | 3V to 30V | 1 μ F 0805 X7R 50V | 1 μ F 1206 X7R 50V | 2.2 μ F 1206 X7R 10V | 1 μ F 0805 X7R 10V | 2V to 4V | 350mA | 19.6k | 43.2k | 450k | 37.4k | 500k |
| 2.7V to 27.5V | 3V to 30V | 1 μ F 0805 X7R 50V | 1 μ F 1206 X7R 50V | 2.2 μ F 1206 X7R 10V | 1 μ F 0805 X7R 10V | 4V to 6V | 350mA | 19.6k | 27.4k | 650k | 18.2k | 900k |
| 3.7V to 23.8V | 3V to 30V | 1 μ F 0805 X7R 50V | 1 μ F 1206 X7R 25V | 2.2 μ F 1206 X7R 10V | 1 μ F 0805 X7R 10V | 6V to 9V | 350mA | 19.6k | 18.2k | 900k | 9.09k | 1.5M |
| 3.8V to 20.2V | 3V to 30V | 1 μ F 0805 X7R 50V | 1 μ F 1206 X7R 25V | 2.2 μ F 1206 X7R 16V | 1 μ F 0805 X7R 16V | 8V to 12V | 350mA | 19.6k | 14.0k | 1.1M | 6.19k | 1.9M |
| 5.3V to 15.2V | 3V to 30V | 1 μ F 0805 X7R 50V | 1 μ F 1206 X7R 25V | 2.2 μ F 1206 X7R 16V | 1 μ F 1206 X7R 25V | 12V to 16V | 350mA | 19.6k | 14.0k | 1.1M | 3.74k | 2.5M |
| 7.4V to 9.3V | 3V to 30V | 1 μ F 0805 X7R 50V | 1 μ F 0805 X7R 16V | 2.2 μ F 1206 X7R 16V | 1 μ F 1206 X7R 25V | 15V to 21V | 350mA | 19.6k | 18.2k | 900k | 3.74k | 2.5M |

APPLICATIONS INFORMATION

Thermal Considerations

The LTM8042/LTM8042-1 output current may need to be derated if it is required to operate in a high ambient temperature or deliver a large amount of continuous power. The amount of current derating is dependent upon the input voltage, output power and ambient temperature. The temperature rise curves given in the Typical Performance Characteristics section can be used as a guide. These curves were generated by an LTM8042/LTM8042-1 mounted to a 51cm² 4-layer FR4 printed circuit board. Boards of other sizes and layer count can exhibit different thermal behavior, so it is incumbent upon the user to verify proper operation over the intended system's line, load and environmental operating conditions.

The thermal resistance numbers listed in the Pin Configuration section of the data sheet are based on modeling the μ Module package mounted on a test board specified per JESD51-9 ("Test Boards for Area Array Surface Mount Package Thermal Measurements"). The thermal coefficients provided are based on JESD 51-12 ("Guidelines for Reporting and Using Electronic Package Thermal Information").

For increased accuracy and fidelity to the actual application, many designers use finite element analysis (FEA) to predict thermal performance. To that end, the Pin Configuration section of the data sheet typically gives four thermal coefficients:

1. θ_{JA} : thermal resistance from junction to ambient.
2. $\theta_{JCBOTTOM}$: thermal resistance from junction to the bottom of the product case.
3. θ_{JCTOP} : thermal resistance from junction to top of the product case.
4. θ_{JB} : thermal resistance from junction to the printed circuit board.

While the meaning of each of these coefficients may seem to be intuitive, JEDEC has defined each to avoid confusion and inconsistency. These definitions are given in JESD 51-12, and are quoted or paraphrased in the following:

1. θ_{JA} is the natural convection junction-to-ambient air thermal resistance measured in a one cubic foot sealed enclosure. This environment is sometimes referred to as "still air" although natural convection causes the air to move. This value is determined with the part mounted to a JESD 51-9 defined test board, which does not reflect an actual application or viable operating condition.
2. $\theta_{JCBOTTOM}$ is the junction-to-board thermal resistance with all of the component power dissipation flowing through the bottom of the package. In the typical μ Module regulator, the bulk of the heat flows out the bottom of the package, but there is always heat flow out into the ambient environment. As a result, this thermal resistance value may be useful for comparing packages but the test conditions don't generally match the user's application.
3. θ_{JCTOP} is determined with nearly all of the component power dissipation flowing through the top of the package. As the electrical connections of the typical μ Module regulator are on the bottom of the package, it is rare for an application to operate such that most of the heat flows from the junction to the top of the part. As in the case of $\theta_{JCBOTTOM}$, this value may be useful for comparing packages but the test conditions don't generally match the user's application.
4. θ_{JB} is the junction-to-board thermal resistance where almost all of the heat flows through the bottom of the μ Module regulator and into the board, and is really the sum of the $\theta_{JCBOTTOM}$ and the thermal resistance of the bottom of the part through the solder joints and through a portion of the board. The board temperature is measured a specified distance from the package, using a two sided, two layer board. This board is described in JESD 51-9.

APPLICATIONS INFORMATION

The most appropriate way to use the coefficients is when running a detailed thermal analysis, such as FEA, which considers all of the thermal resistances simultaneously. None of them can be individually used to accurately predict the thermal performance of the product, so it would be inappropriate to attempt to use any one coefficient to correlate to the junction temperature versus load graphs given in the LTM8042/LTM8042-1 data sheet.

A graphical representation of these thermal resistances is given in Figure 5.

The blue resistances are contained within the μ Module regulator, and the green are outside.

The die temperature of the LTM8042/LTM8042-1 must be lower than the maximum rating of 125°C, so care should be taken in the layout of the circuit to ensure good heat sinking of the LTM8042/LTM8042-1. The bulk of the heat flow out of the LTM8042/LTM8042-1 is through the bottom of the module and the LGA pads into the printed circuit board. Consequently, a poor printed circuit board design can cause excessive heating, resulting in impaired performance or reliability. Please refer to the PCB Layout section for printed circuit board design suggestions.

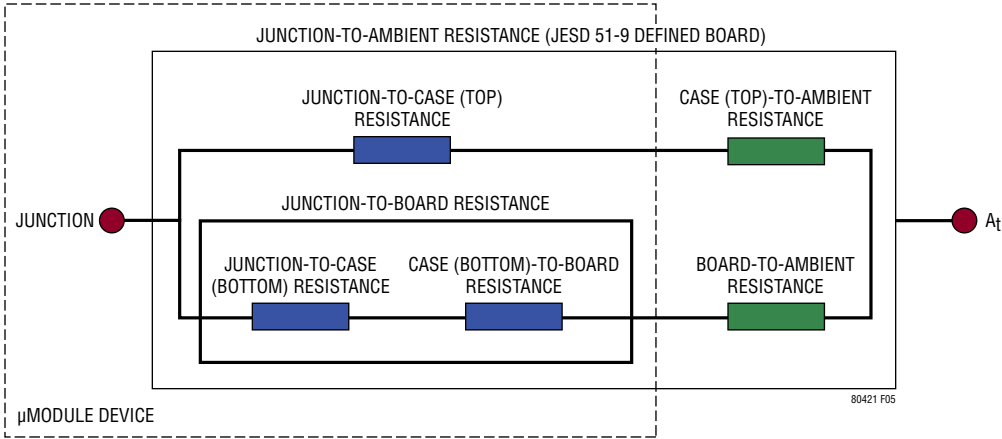
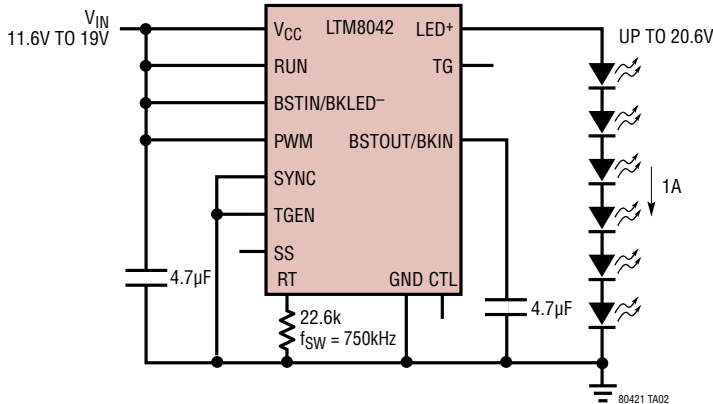

Figure 5

TYPICAL APPLICATIONS

Boost Operation, Driving 6 White LEDs at 1A



TYPICAL APPLICATIONS

Buck-Boost Mode, Driving 5 White LEDs at 500mA with PWM Dimming

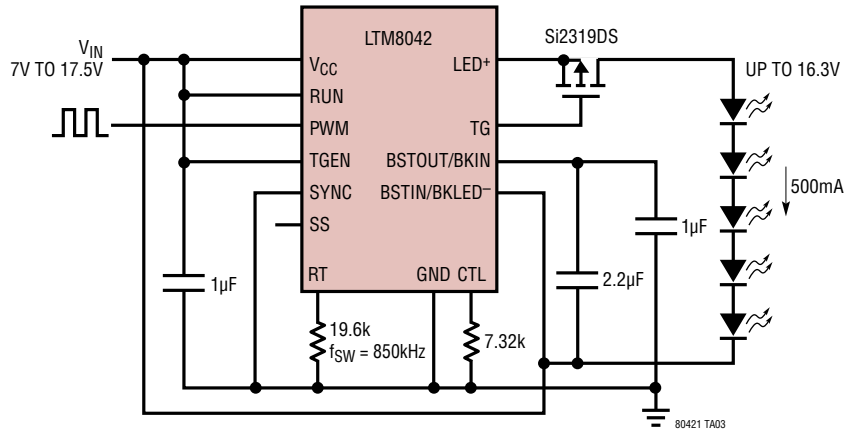

Buck Mode, Driving 4 White LEDs at 1A

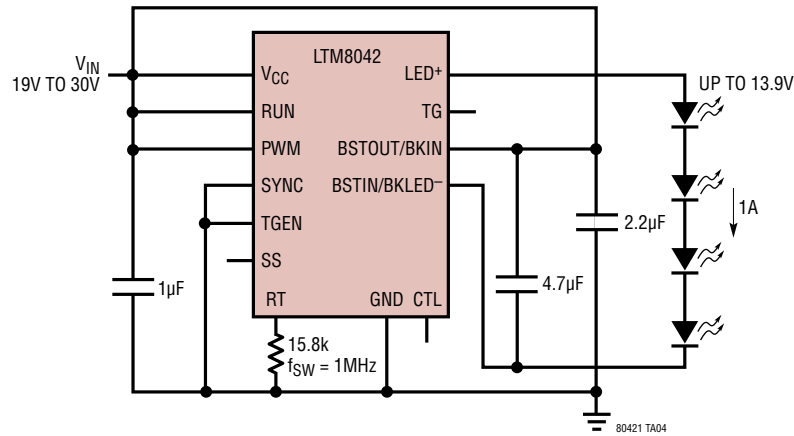

Boost Operation, Driving 9 White LEDs at 100mA

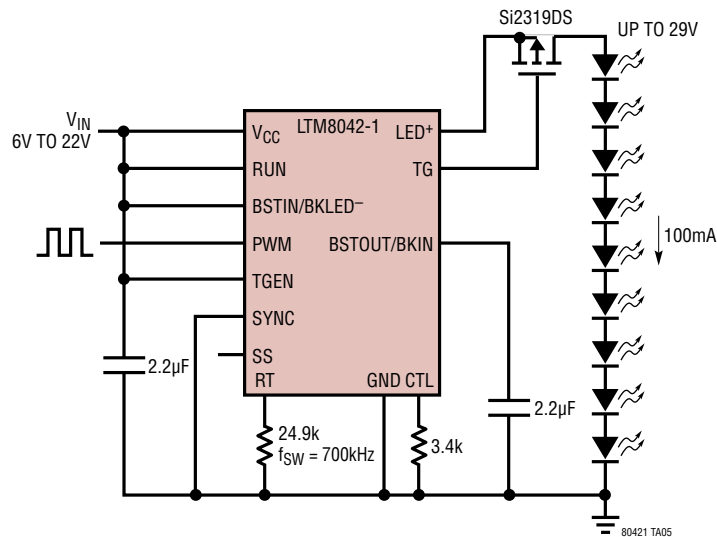

PACKAGE DESCRIPTION

Pin Assignment Table
(Arranged by Pin Number)

| PIN | NAME | PIN | NAME | PIN | NAME | PIN | NAME | PIN | NAME | PIN | NAME |
|-----|-----------------|-----|-----------------|-----|--------------|-----|--------------|-----|------|-----|------|
| A1 | GND | B1 | GND | C1 | GND | D1 | GND | E1 | GND | F1 | RUN |
| A2 | GND | B2 | GND | C2 | GND | D2 | GND | E2 | GND | F2 | GND |
| A3 | GND | B3 | GND | C3 | GND | D3 | GND | E3 | GND | F3 | GND |
| A4 | GND | B4 | GND | C4 | GND | D4 | GND | E4 | GND | F4 | GND |
| A5 | GND | B5 | GND | C5 | BSTIN/BKLED- | D5 | BSTIN/BKLED- | E5 | GND | F5 | GND |
| A6 | V _{CC} | B6 | V _{CC} | C6 | BSTIN/BKLED- | D6 | BSTIN/BKLED- | E6 | GND | F6 | GND |
| A7 | V _{CC} | B7 | V _{CC} | C7 | BSTIN/BKLED- | D7 | BSTIN/BKLED- | E7 | GND | F7 | GND |

| PIN | NAME | PIN | NAME | PIN | NAME | PIN | NAME | PIN | NAME |
|-----|-------------|-----|-------------|-----|-------------|-----|------|-----|------|
| G1 | SYNC | H1 | RT | J1 | SS | K1 | PWM | L1 | GND |
| G2 | GND | H2 | GND | J2 | GND | K2 | GND | L2 | CTL |
| G3 | GND | H3 | GND | J3 | GND | K3 | GND | L3 | TGEN |
| G4 | GND | H4 | GND | J4 | GND | K4 | GND | L4 | GND |
| G5 | BSTOUT/BKIN | H5 | BSTOUT/BKIN | J5 | BSTOUT/BKIN | K5 | LED+ | L5 | LED+ |
| G6 | BSTOUT/BKIN | H6 | BSTOUT/BKIN | J6 | BSTOUT/BKIN | K6 | LED+ | L6 | LED+ |
| G7 | BSTOUT/BKIN | H7 | BSTOUT/BKIN | J7 | TG | K7 | LED+ | L7 | LED+ |

PACKAGE PHOTOGRAPH

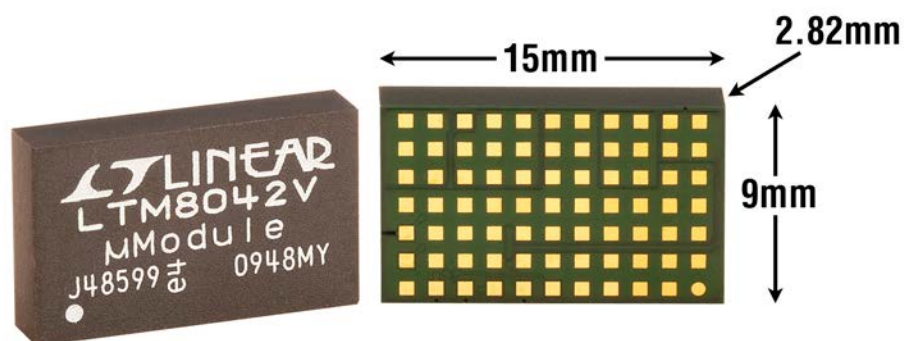

PACKAGE DESCRIPTION

LGA Package
77-Lead (15mm × 9mm × 2.82mm)
 (Reference LTC DWG # 05-08-1859 Rev 0)

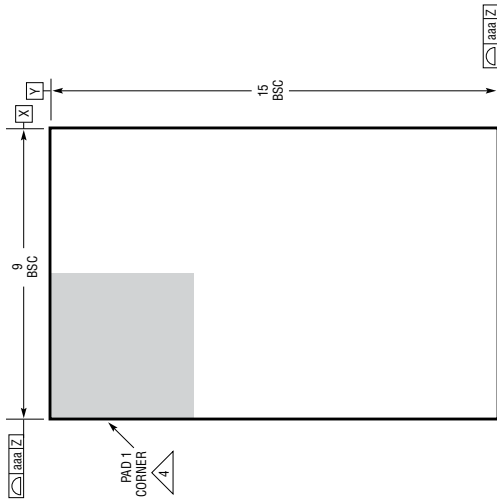
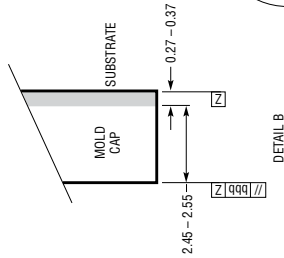
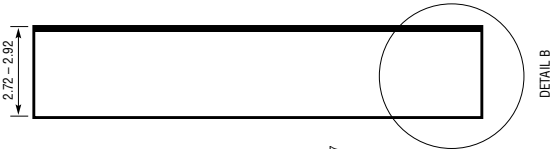
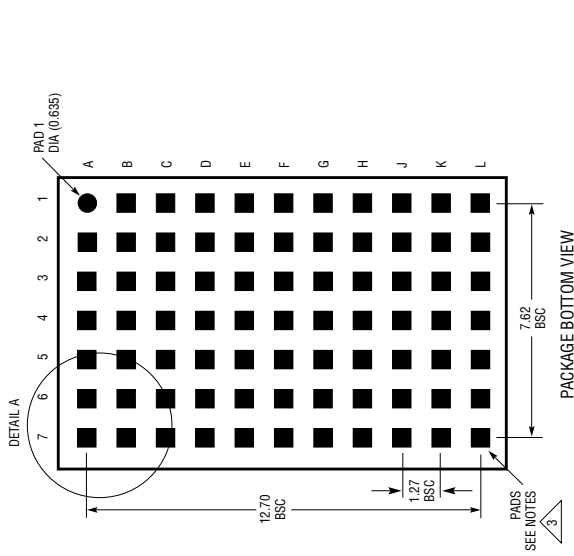

PACKAGE TOP VIEW

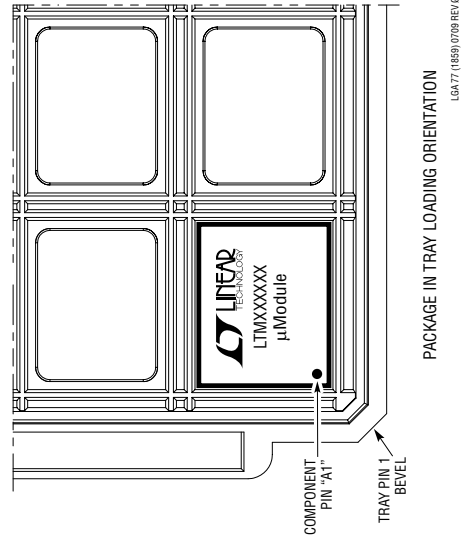
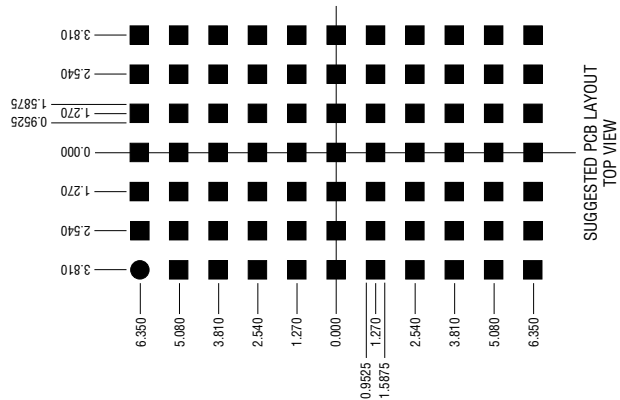

PACKAGE IN TRAY LOADING ORIENTATION
 LGA77 (1859) 07/09 REV 0

- NOTES:
1. DIMENSIONING AND TOLERANCING PER ASME Y14.5M-1994
 2. ALL DIMENSIONS ARE IN MILLIMETERS
 3. LAND DESIGNATION PER JEDEC MO-222, SPP-010
 4. DETAILS OF PAD #1 IDENTIFIER ARE OPTIONAL, BUT MUST BE LOCATED WITHIN THE ZONE INDICATED. THE PAD #1 IDENTIFIER MAY BE EITHER A MOLD OR MARKED FEATURE
 5. PRIMARY DATUM - Z - IS SEATING PLANE
 6. THE TOTAL NUMBER OF PADS: 77

| SYMBOL | TOLERANCE |
|--------|-----------|
| aaa | 0.15 |
| bbb | 0.10 |
| eee | 0.05 |

REVISION HISTORY

| REV | DATE | DESCRIPTION | PAGE NUMBER |
|-----|-------|---|-------------|
| A | 01/11 | Updated features. | 1 |
| | | Updated I_{LED} conditions in the Electrical Characteristics section. | 3 |
| | | Updated text in the Operation section. | 15 |
| | | Updated text in the Setting the Switching Frequency section. | 16 |
| B | 11/14 | Corrected Top Mark for LTM8042-1 | 2 |

TYPICAL APPLICATION

Boost Operation, Driving 9 Red LEDs at 350mA with Analog Dimming

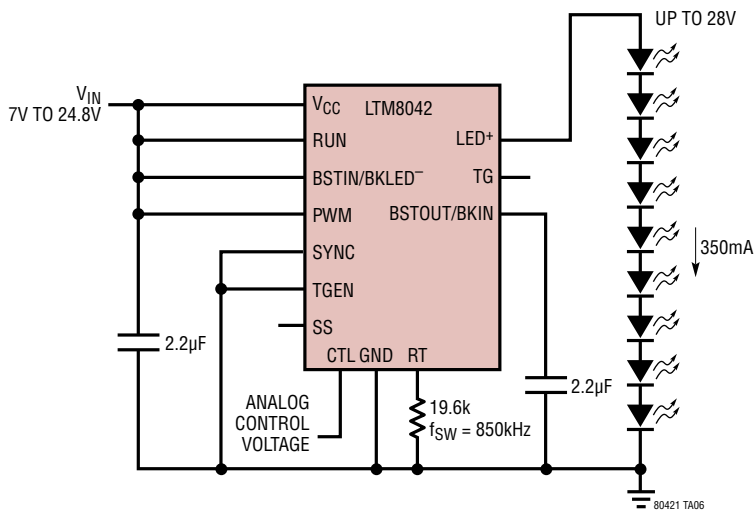

RELATED PARTS

| PART NUMBER | DESCRIPTION | COMMENTS |
|-------------|--|--|
| LTM8040 | 36V, 1A, µModule LED Driver and Current Source | $4V \leq V_{IN} \leq 36V$; Open LED and Short-Circuit Protection, 9mm × 15mm × 4.32mm LGA Package |
| LTM8032 | EMC 36V, 2A, µModule Regulator | EN55022 Class B Compliant; $0.8V \leq V_{OUT} \leq 10V$ |
| LTM4607 | Buck-Boost µModule Regulator | $4.5V \leq V_{IN} \leq 36V$; $0.8V \leq V_{OUT} \leq 25V$, 15mm × 15mm × 2.8mm |

Looking for pricing, stock, or lifecycle information?

Click below to explore more details on WIN SOURCE:

 [View LTM8042IV#PBF on WIN SOURCE](#)

 [Linear Technology](#) Information

Optimize Your Supply Chain with WIN SOURCE Solutions

-  Global Sourcing Solution
-  Obsolete Management
-  Cost Control Management
-  Shortage Management
-  Alternative Solution
-  Excess Inventory Management