



**THE DATASHEET OF  
LTC4231IUD-1#PBF**





# LTC4231

## ABSOLUTE MAXIMUM RATINGS (Notes 1, 2)

Supply Voltage		GATE–SENSE .....	–40V to 20V
IN .....	–40V to 40V	STATUS .....	–0.3V to 40V
Input Voltages		TIMER .....	–0.3V to 4V
SENSE, SOURCE .....	–40V to 40V	Operating Ambient Temperature Range	
IN–SENSE .....	–40V to 40V	LTC4231C .....	0°C to 70°C
SHDN, UVL, UVH, OV, GNDSW .....	–0.3V to 40V	LTC4231I .....	–40°C to 85°C
Input Currents		LTC4231H .....	–40°C to 125°C
SHDN, UVL, UVH, OV, GNDSW (Note 3) .....	–1mA	Storage Temperature Range .....	–65°C to 150°C
Output Voltages		Lead Temperature (Soldering, 10 sec)	
GATE–SOURCE (Note 4) .....	–0.3V to 13V	MSOP Package .....	300°C

## PIN CONFIGURATION

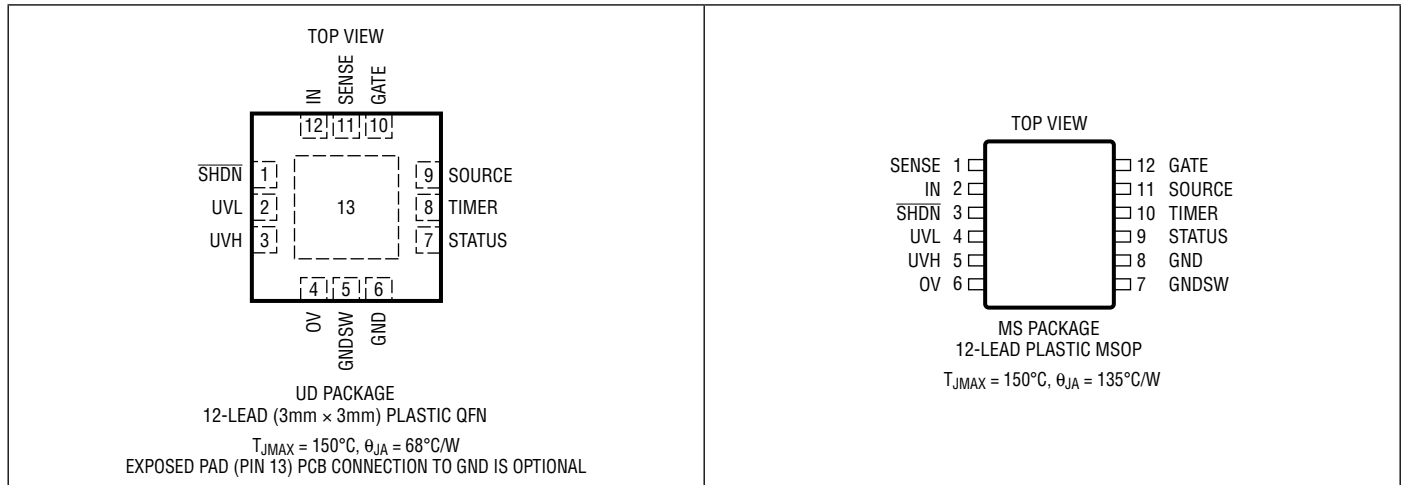

## ORDER INFORMATION

LEAD FREE FINISH	TAPE AND REEL	PART MARKING	PACKAGE DESCRIPTION	TEMPERATURE RANGE
LTC4231CUD-1#PBF	LTC4231CUD-1#TRPBF	LGMX	12-Lead (3mm × 3mm) Plastic QFN	0°C to 70°C
LTC4231CUD-2#PBF	LTC4231CUD-2#TRPBF	LGSP	12-Lead (3mm × 3mm) Plastic QFN	0°C to 70°C
LTC4231IUD-1#PBF	LTC4231IUD-1#TRPBF	LGMX	12-Lead (3mm × 3mm) Plastic QFN	–40°C to 85°C
LTC4231IUD-2#PBF	LTC4231IUD-2#TRPBF	LGSP	12-Lead (3mm × 3mm) Plastic QFN	–40°C to 85°C
LTC4231HUD-1#PBF	LTC4231HUD-1#TRPBF	LGMX	12-Lead (3mm × 3mm) Plastic QFN	–40°C to 125°C
LTC4231HUD-2#PBF	LTC4231HUD-2#TRPBF	LGSP	12-Lead (3mm × 3mm) Plastic QFN	–40°C to 125°C

## ORDER INFORMATION

LEAD FREE FINISH	TAPE AND REEL	PART MARKING	PACKAGE DESCRIPTION	TEMPERATURE RANGE
LTC4231CMS-1#PBF	LTC4231CMS-1#TRPBF	42311	12-Lead Plastic MSOP	0°C to 70°C
LTC4231CMS-2#PBF	LTC4231CMS-2#TRPBF	42312	12-Lead Plastic MSOP	0°C to 70°C
LTC4231IMS-1#PBF	LTC4231IMS-1#TRPBF	42311	12-Lead Plastic MSOP	-40°C to 85°C
LTC4231IMS-2#PBF	LTC4231IMS-2#TRPBF	42312	12-Lead Plastic MSOP	-40°C to 85°C
LTC4231HMS-1#PBF	LTC4231HMS-1#TRPBF	42311	12-Lead Plastic MSOP	-40°C to 125°C
LTC4231HMS-2#PBF	LTC4231HMS-2#TRPBF	42312	12-Lead Plastic MSOP	-40°C to 125°C

Consult LTC Marketing for parts specified with wider operating temperature ranges.

Consult LTC Marketing for information on nonstandard lead based finish parts.

For more information on lead free part marking, go to: <http://www.linear.com/leadfree/>

For more information on tape and reel specifications, go to: <http://www.linear.com/tapeandreeel/>

## ELECTRICAL CHARACTERISTICS

The ● denotes the specifications which apply over the full operating temperature range, otherwise specifications are at  $T_A = 25^\circ\text{C}$ .  $I_{IN} = 12\text{V}$ , unless otherwise noted.

SYMBOL	PARAMETER	CONDITIONS	MIN	TYP	MAX	UNITS	
<b>IN</b>							
$V_{IN}$	Input Supply Voltage Range		●	2.7	36	V	
$V_{IN(UVL)}$	Input Supply Undervoltage Lockout	IN Rising	●	2	2.3	2.6	V
$\Delta V_{IN(HYST)}$	Input Supply Undervoltage Lockout Hysteresis			200		mV	
$I_{CC}$	Supply Current (Average) Normal On, Voltage or Current Fault	(Note 5) $I_{GATE} \leq -0.1\mu\text{A}$ , $C_{GATE-SOURCE} = 1\text{nF}$ , (C-Grade, I-Grade) (H-Grade)	●	4	10	$\mu\text{A}$	
	Start-Up or Overcurrent Shutdown	$\overline{\text{SHDN}}$ Low, GATE Pulled to GND, (C-Grade, I-Grade) (H-Grade)	●	300	600	$\mu\text{A}$	
	Reverse Input	IN, SENSE = -40V	●	0.3	1	$\mu\text{A}$	
			●	0.3	2	$\mu\text{A}$	
			●	-2.5	-5	mA	
<b>SENSE</b>							
$\Delta V_{SENSE(CB)}$	Circuit Breaker Threshold ( $V_{IN} - V_{SENSE}$ )		●	47	50	53	mV
$\Delta V_{SENSE(ACL)}$	Analog Current Limit	During Output Short-Circuit	●	65	80	90	mV
$I_{SENSE}$	SENSE Input Current	$\overline{\text{SHDN}} = \text{High}$ , SENSE = 12V	●	0.3	1	$\mu\text{A}$	
<b>GATE, SOURCE</b>							
$\Delta V_{GATE}$	External N-Channel Gate Drive ( $V_{GATE} - V_{SOURCE}$ )	$V_{IN} < 7\text{V}$ , $I_{GATE} = 0$ , $-0.1\mu\text{A}$ $V_{IN} \geq 7\text{V}$ , $I_{GATE} = 0$ , $-0.1\mu\text{A}$	●	4.5	6.2	10	V
			●	10	11.4	18	V
$\Delta V_{GATE(H)}$	$\Delta V_{GATE}$ ( $V_{GATE} - V_{SOURCE}$ ) Threshold That Deactivates the Charge Pump	$V_{IN} < 7\text{V}$ $V_{IN} \geq 7\text{V}$	●	5.5	6.5	10	V
			●	11	11.7	18	V
$V_{GATE(L)}$	GATE Low Threshold	To Enter Shutdown or Voltage Fault	●	0.4	1.2	1.8	V
$I_{GATE(UP)}$	GATE Pull-Up Current	GATE On, GATE = 1V	●	-7	-10	-13	$\mu\text{A}$
$I_{GATE(FAST)}$	GATE Fast Pull-Down Current	$\Delta V_{SENSE} = 0.5\text{V}$ , $\Delta V_{GATE} = 5\text{V}$	●	70	130	mA	
$I_{GATE(SLOW)}$	GATE Slow Pull-Down Current	$\overline{\text{SHDN}} = 0\text{V}$ , $\Delta V_{GATE} = 5\text{V}$	●	0.6	1	mA	
$t_{D(ON)}$	Turn-On Debounce Delay	UVL = UVH = 2V, 0V = 0V, $\overline{\text{SHDN}} = \text{Step } 0\text{V to } 5\text{V}$	●	20	40	60	ms
$t_{RETRY}$	Auto-Retry Delay	LTC4231-2	●	0.27	0.5	0.73	s
$t_{PHL(ILIM)}$	Overcurrent to GATE Low Propagation Delay	$\Delta V_{SENSE} = \text{Step } 0\text{mV to } 300\text{mV}$ , $C_{GATE} = 1\text{nF}$ , $\Delta V_{GATE}$ Crosses 1V	●	0.5	1	$\mu\text{s}$	

## ELECTRICAL CHARACTERISTICS

The ● denotes the specifications which apply over the full operating temperature range, otherwise specifications are at  $T_A = 25^\circ\text{C}$ .  $I_N = 12\text{V}$ , unless otherwise noted.

SYMBOL	PARAMETER	CONDITIONS	MIN	TYP	MAX	UNITS	
<b>UVL, UVH, OV, GNDSW, STATUS and SHDN</b>							
$V_{UV}$	UVL, UVH Threshold		● 0.776	0.795	0.814	V	
$V_{OV}$	OV Threshold	OV Rising	● 0.776	0.795	0.814	V	
$V_{OV(HYST)}$	OV Hysteresis		● 3	15	30	mV	
$I_{LEAK(0.9V)}$	UVL, UVH and OV Leakage Current	V = 0.9V (C-Grade, I-Grade) (H-Grade)	●	0	±10	nA	
			●	0	±100	nA	
$I_{LEAK(12V)}$	UVL, UVH, OV, GNDSW, STATUS and SHDN Leakage Current	V = 12V (C-Grade, I-Grade) (H-Grade)	●	0	±100	nA	
			●	0	±500	nA	
$R_{ON(GNDSW)}$	Switch Resistance		●	80	200	$\Omega$	
$V_{OL}$	STATUS Output Low Voltage	I = 2mA	●	0.2	0.4	V	
$V_{SHDN}$	SHDN Input Threshold		●	0.4	0.8	1.5	V
$t_{PERIOD}$	Sampling Period		●	5	10	15	ms
$t_{SAMPLE}$	Sampling Width		●	100	200	300	$\mu\text{s}$
<b>TIMER</b>							
$t_{CB}$	Circuit Breaker Delay	$C_T = 100\text{nF}$	●	1.7	2.4	3.5	ms
$V_{TIMER(H)}$	TIMER High Threshold	TIMER Rising	●	1.170	1.193	1.216	V
$V_{TIMER(L)}$	TIMER Low Threshold	TIMER Falling	●	0.07	0.1	0.13	V
$I_{TIMER(UP)}$	TIMER Pull-Up Current	TIMER = 0.5V, Circuit Breaker Tripped	●	-35	-50	-65	$\mu\text{A}$
$I_{TIMER(DN)}$	TIMER Pull-Down Current	TIMER = 0.5V, Circuit Breaker Recovery	●	3	5	7	$\mu\text{A}$

**Note 1:** Stresses beyond those listed under Absolute Maximum Ratings may cause permanent damage to the device. Exposure to any Absolute Maximum Rating condition for extended periods may affect device reliability and lifetime.

**Note 2:** All currents into device pins are positive; all currents out of device pins are negative. All voltages are referenced to GND unless otherwise specified.

**Note 3:** These pins can be tied to voltages below -0.3V through a resistance that limits the current below 1mA.

**Note 4:** An internal clamp limits GATE to a minimum of 13V above SOURCE. Driving this pin to voltages beyond this clamp may damage the device.

**Note 5:** For modes where GATE is pulled to GND,  $I_{CC} = I_{IN} + I_{SENSE}$ . Else  $I_{CC} = I_{IN} + I_{SENSE} + I_{SOURCE}$ .

# TYPICAL PERFORMANCE CHARACTERISTICS

**Average Supply Current vs IN**

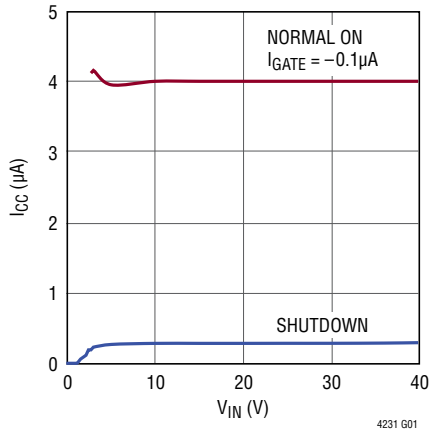

**Average Supply Current (Normal On) vs GATE Leakage**

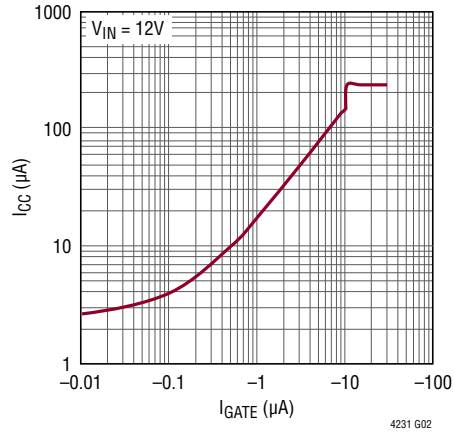

**Average Supply Current vs Temperature**

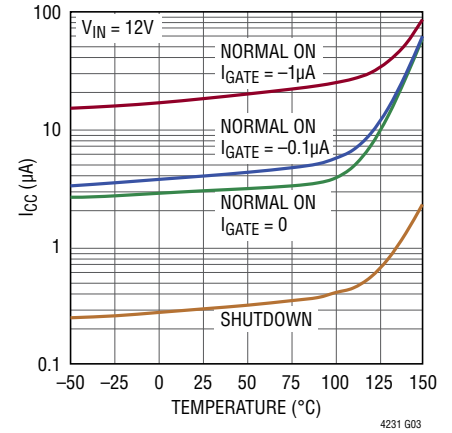

**Supply Current (Reverse Input) vs IN**

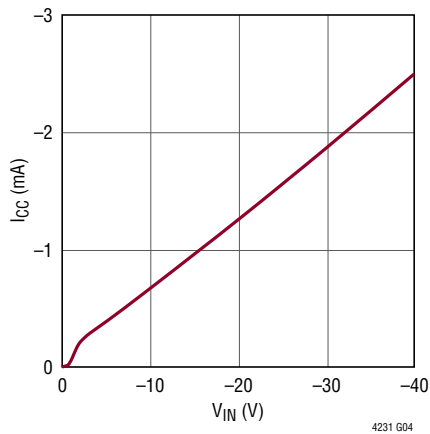

**ΔVGATE (Average) vs IN**

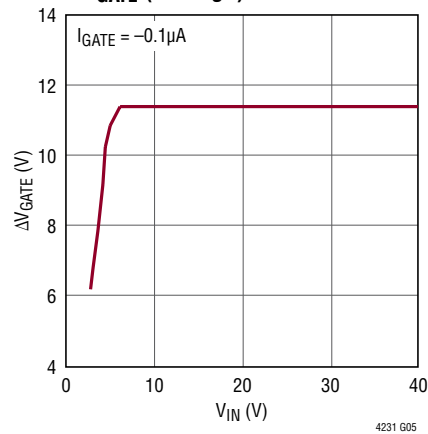

**ΔVGATE (Average) vs GATE Leakage**

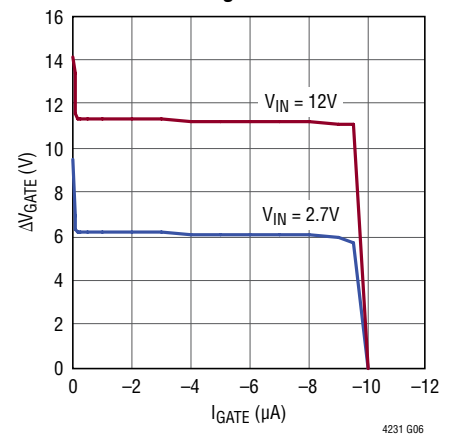

## TYPICAL PERFORMANCE CHARACTERISTICS

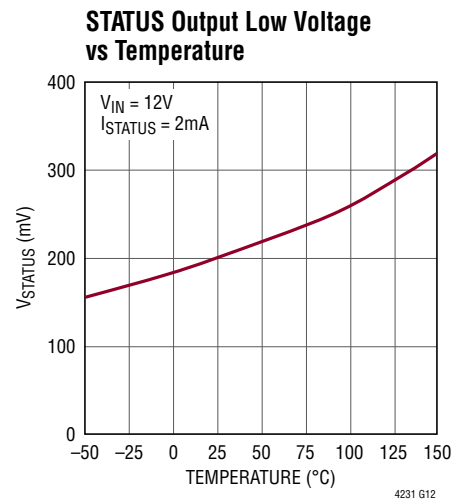
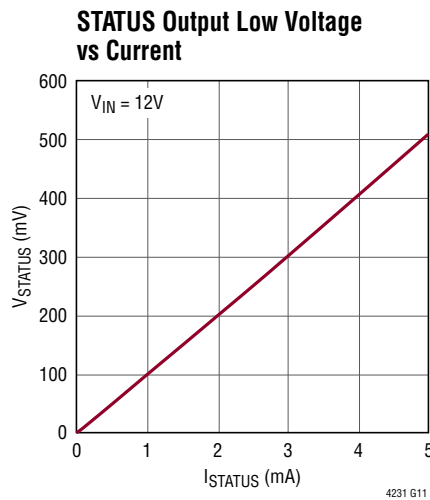
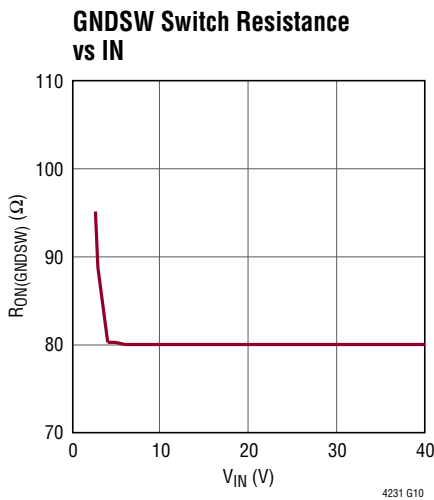
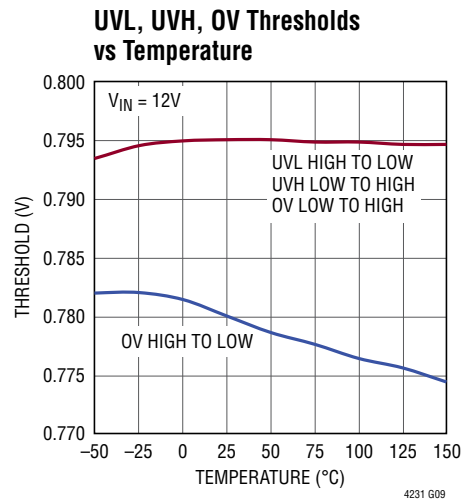
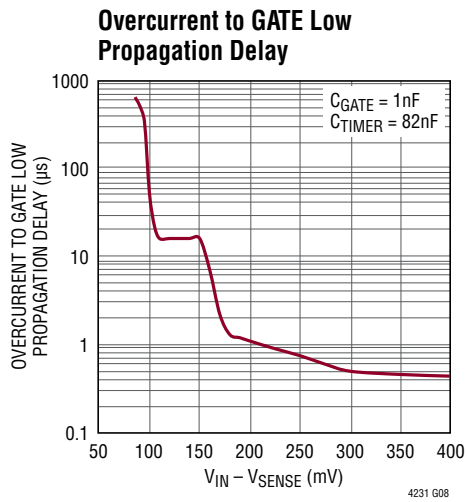
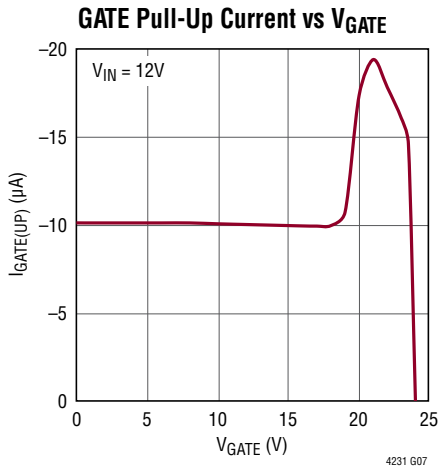

## PIN FUNCTIONS

**GATE:** Gate Drive for External N-Channel MOSFET. After all start-up conditions are satisfied, a 10 $\mu$ A pull-up current from the internal charge pump charges up  $\Delta V_{GATE}$  to the high threshold voltage  $\Delta V_{GATE(H)}$  and then turns off. The charge pump turns on again when  $\Delta V_{GATE}$  decays by more than 0.7V or every 15ms, whichever comes first, and recharges  $\Delta V_{GATE}$  to  $\Delta V_{GATE(H)}$ . During GATE turn-off, a 1mA pull-down current discharges GATE to GND. During severe short circuits, a 130mA pull-down current is activated to discharge GATE to SOURCE.

**GND:** Device Ground.

**GNDSW:** Switched GND. Connect this pin to an external resistive network to monitor IN for overvoltage or undervoltage (OV/UV). To reduce the power dissipated by this resistive divider, the LTC4231 periodically samples IN by connecting GNDSW to GND once every 10ms. Tie this pin to GND if unused.

**IN:** Supply Voltage and Current Sense Input. This pin has a nominal undervoltage lockout threshold of 2.3V.

**SHDN:** Shutdown Control Input. A logic high at  $\overline{SHDN}$  enables the LTC4231. GATE ramps up after a debounce delay of 40ms. A logic low at  $\overline{SHDN}$  activates a 1mA pull-down current at GATE, discharging it to GND. Once GATE < 1.2V, the LTC4231 enters a low current Shutdown. Connect to IN if unused. When connected to IN, if IN goes below ground, use a resistor to limit the current to  $\leq 1$ mA.

**OV:** Overvoltage Comparator Input. Connect this pin to an external resistive network to monitor IN for OV. This pin connects internally to an overvoltage comparator with a 0.795V threshold. To reduce the power dissipated by this resistive divider, the LTC4231 periodically samples IN by connecting GNDSW to GND once every 10ms. Once an OV is detected at IN, GATE and STATUS pull low. Tie this pin to GND if unused.

**SENSE:** Current Sense Input. Connect to the output of the current sense resistor. The circuit breaker comparator and the analog current limit amplifier monitor the voltage across the current sense resistor. During an overcurrent fault when  $\Delta V_{SENSE}$  exceeds 50mV, the circuit breaker comparator trips and triggers TIMER to ramp up. For more severe overcurrent faults, the analog current limit amplifier controls the gate of the external MOSFET to keep  $\Delta V_{SENSE}$  at 80mV. To disable the circuit breaker comparator and analog current limit amplifier, connect this pin to IN.

**SOURCE:** N-Channel MOSFET Source Connection. Connect this pin to the source of the external MOSFET.

**STATUS:** Status Output. Open-drain output that goes high impedance when  $\Delta V_{GATE}$  first exceeds  $\Delta V_{GATE(H)}$ . The state of the pin is latched and resets (pulls low) when  $\overline{SHDN}$  goes low, an UVLO occurs, an OV/UV is detected at IN or an overcurrent fault sets the internal current fault latch. This pin may be left open if unused.

**TIMER:** Timer Input. Connect a capacitor between this pin and GND to set a 24ms/ $\mu$ F duration for overcurrent before the internal current fault latch trips and turns off the MOSFET. For the LTC4231-1 latching option, the MOSFET remains off until the current fault latch is cleared by pulling  $\overline{SHDN}$  low or by cycling power. For the LTC4231-2 auto-retry option, the current fault latch is cleared automatically and the GATE is ramped up after a 500ms delay.

**UVH, UVL:** Undervoltage Comparator Input. Connect these pins to an external resistive network to monitor IN for UV. These pins connect internally to an undervoltage comparator with a 0.795V threshold. The comparator monitors UVH when GATE is low and UVL when GATE is high to implement separate undervoltage turn-on and undervoltage turn-off thresholds. To reduce the power dissipated by this resistive divider, the LTC4231 periodically samples IN by connecting GNDSW to GND once every 10ms. Once an UV is detected at these pins, GATE and STATUS pull low. Tie both pins to IN if unused. When connected to IN, for applications where IN goes below ground, use a resistor to limit the current to  $\leq 1$ mA.

**Exposed Pad (QFN Package):** The exposed pad may be left open or connected to device ground.

FUNCTIONAL DIAGRAM

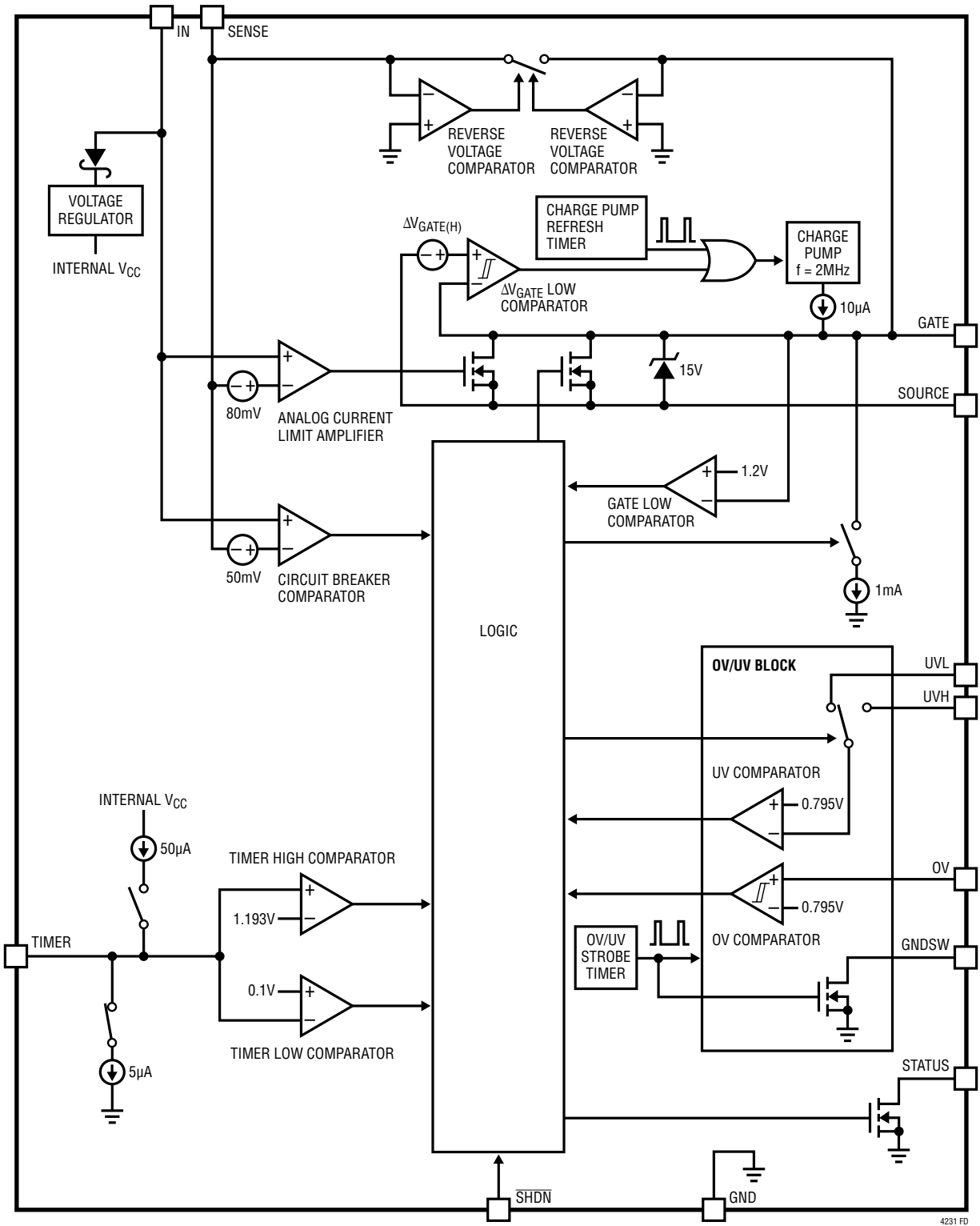

4231 FD

## OPERATION

The LTC4231 is a micropower Hot Swap controller that controls an external N-channel MOSFET to turn on and off a supply voltage in a controlled manner. This allows a circuit to be safely inserted and removed from a powered connector without glitches or connector damage from uncontrolled inrush current.

When the LTC4231 is first powered up, the gate of the MOSFET is held at GND to keep it off. Pulling  $\overline{\text{SHDN}}$  high and  $\text{IN}$  above undervoltage lockout (UVLO) starts an internal clock that monitors the resistive divider at  $\text{IN}$  once every 10ms by connecting  $\text{GNDSW}$  to GND. A 40ms debounce cycle is also started. Average  $I_{\text{CC}}$  during this debounce mode is 4 $\mu\text{A}$ .

After the 40ms debounce cycle, the LTC4231 goes into start-up mode to ramp up GATE. In this mode, all circuits blocks except the overvoltage or undervoltage (OV/UV) block are activated and  $I_{\text{CC}} = 300\mu\text{A}$ . The internal charge pump supplies a 10 $\mu\text{A}$  pull-up current to GATE. Once  $\Delta V_{\text{GATE}}$  exceeds  $\Delta V_{\text{GATE(H)}}$ , STATUS goes high impedance. This indicates that GATE is high and the power path is on. Average  $I_{\text{CC}}$  drops to 4 $\mu\text{A}$  during this normal on mode as some circuit blocks are shut down and the internal charge pump periodically turns on to recharge GATE as needed. The periodic monitoring of the  $\text{IN}$  resistive divider continues as long as  $\overline{\text{SHDN}}$  is high and  $\text{IN} \geq 2.3\text{V}$ .

If an OV/UV violation is detected during the  $\text{IN}$  monitoring time, the part goes into voltage fault mode (average  $I_{\text{CC}} = 4\mu\text{A}$ ) where GATE and STATUS is pulled to GND. The debounce cycle restarts when no OV/UV violation is detected during a subsequent  $\text{IN}$  monitoring window.

The LTC4231 has a circuit breaker comparator that monitors the voltage across the current sense resistor. This comparator trips when  $\Delta V_{\text{SENSE}}$  exceeds 50mV, bringing the LTC4231 into overcurrent mode. In this mode, all circuits blocks except the OV/UV block are activated and  $I_{\text{CC}} = 300\mu\text{A}$ . If  $\Delta V_{\text{SENSE}} > 80\text{mV}$ , the analog current limit amplifier limits  $\Delta V_{\text{SENSE}}$  to 80mV by servoing  $\Delta V_{\text{GATE}}$  in an active control loop. The TIMER capacitor is ramped up with a 50 $\mu\text{A}$  pull-up when  $\Delta V_{\text{SENSE}} > 50\text{mV}$ . When  $\text{TIMER} > 1.193\text{V}$ , the current fault latch is set, causing GATE and STATUS to pull low. The part goes into current fault mode.

In current fault mode, the latchoff (LTC4231-1) version keeps TIMER and GATE low. The auto-retry (LTC4231-2) version waits 500ms before GATE is ramped up again. For both versions, the part can be reset by cycling  $\overline{\text{SHDN}}$  low then high or by cycling  $\text{IN}$  to GND and back. After the reset, the LTC4231 goes through a debounce cycle before re-starting GATE.

$\overline{\text{SHDN}}$  acts as a shutdown switch for the supply path. When it goes high, the LTC4231 ramps GATE up after a debounce cycle to turn on the external MOSFET. When it goes low, GATE is pulled to GND to turn off the external MOSFET. The LTC4231 then goes into shutdown mode where  $I_{\text{CC}}$  drops to 0.3 $\mu\text{A}$ .

$\text{IN}$ , SENSE, GATE and SOURCE are protected against reverse inputs of up to  $-40\text{V}$ . Two reverse voltage comparators detect negative input potentials at SENSE or GATE and quickly connect GATE to SENSE. When used with back-to-back MOSFETs as shown in Figure 5, this feature will isolate the load from a negative input.

APPLICATIONS INFORMATION

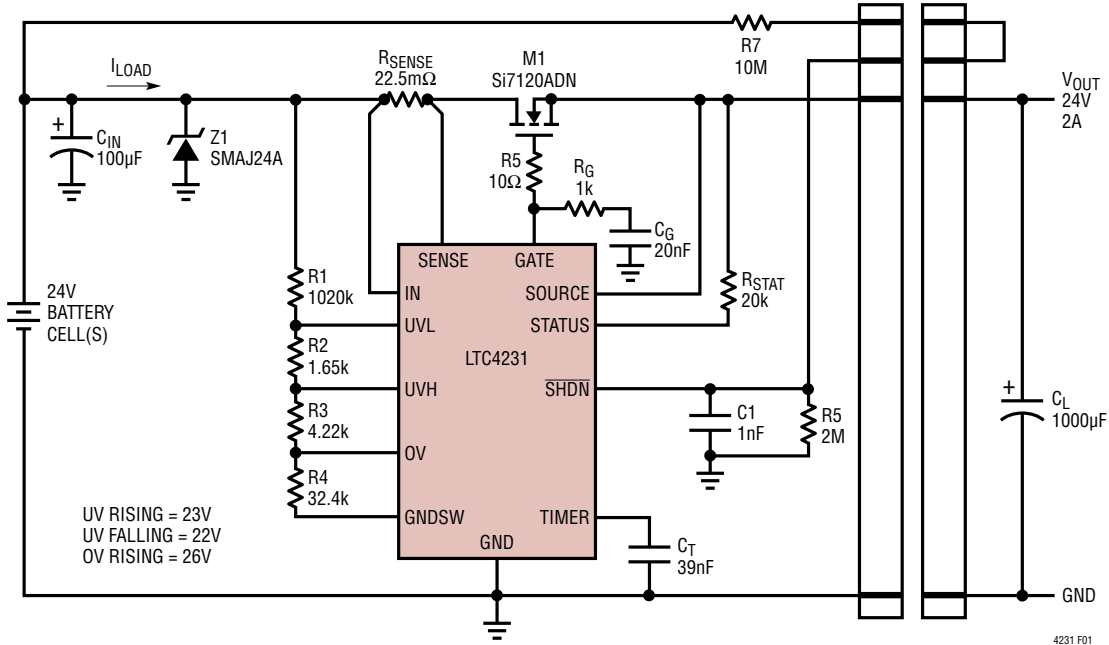

Figure 1. Channel Controller with Connector Enable

The micropower capability of the LTC4231 makes it ideal for Hot Swap applications in battery powered systems where current load is light or intermittent and power draw is a concern. It can implement battery short circuit protection, reverse battery protection, battery voltage monitoring, power path control, hot-plug and inrush current control in off-grid, autonomous systems.

Turn-On Sequence

When IN is less than the UVLO level of 2.3V or  $\overline{\text{SHDN}}$  is low, GATE is pulled to GND and STATUS pulls low. When  $\text{IN} \geq 2.3\text{V}$  and  $\overline{\text{SHDN}}$  goes high, an internal clock starts timing a 40ms debounce cycle. The clock also times a 200µs strobe of the resistive divider at IN every 10ms to make sure IN is not in OV/UV. Average  $\text{I}_{\text{CC}}$  during this debounce mode is 4µA.

Any OV/UV detected will stop and reset the debounce timing cycle. During this voltage fault mode, average  $\text{I}_{\text{CC}}$  is 4µA. The debounce cycle only restarts when a subsequent IN strobe indicates that the input power is within the acceptable range,  $\text{IN} \geq 2.3\text{V}$  and  $\overline{\text{SHDN}}$  is high.

When the debounce cycle of 40ms successfully completes, the LTC4231 turns on its charge pump, analog current limit amplifier and TIMER control circuit blocks as it goes

into start-up mode ( $\text{I}_{\text{CC}} = 300\mu\text{A}$ ). The external MOSFET is turned on by charging up the GATE with a 10µA charge pump generated current source.

At start-up, the MOSFET current is typically dominated by the current charging the load capacitor  $\text{C}_{\text{L}}$ . If  $\Delta\text{V}_{\text{SENSE}} > 80\text{mV}$ , the analog current limit amplifier controls the gate of the MOSFET in a closed loop. This keeps the start-up inrush current at  $80\text{mV}/\text{R}_{\text{SENSE}}$ . When  $\Delta\text{V}_{\text{SENSE}} > 50\text{mV}$ , the TIMER capacitor charges up with an internal 50µA pull-up current.

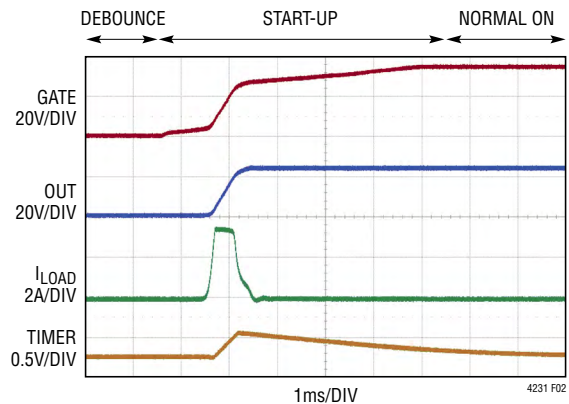

Figure 2. Inrush Control by Analog Current Limit

## APPLICATIONS INFORMATION

In most applications, keeping the inrush current at analog current limit is an acceptable start-up method if the TIMER delay is long enough to avoid setting the current fault latch and the MOSFET has adequate safe operating margin. However, for more flexibility in design (See the Design Example section), a capacitor from GATE to GND (Figure 1) can be used to limit the  $V_{GATE}$  slew rate for inrush current control.  $V_{GATE}$  rises with a slope equal to  $10\mu A/C_G$  (Figure 3). The supply inrush current is then limited to:

$$I_{INRUSH} = \frac{C_L}{C_G} \cdot 10\mu A$$

Once  $\Delta V_{GATE}$  exceeds  $\Delta V_{GATE(H)}$ , STATUS goes high impedance.  $I_{CC}$  drops from  $300\mu A$  to  $4\mu A$  (average) during this normal on mode as some circuit blocks are shut down and the internal charge pump periodically turns on when  $\Delta V_{GATE}$  droops by  $0.7V$  or every  $15ms$ , whichever comes first (Figure 7).

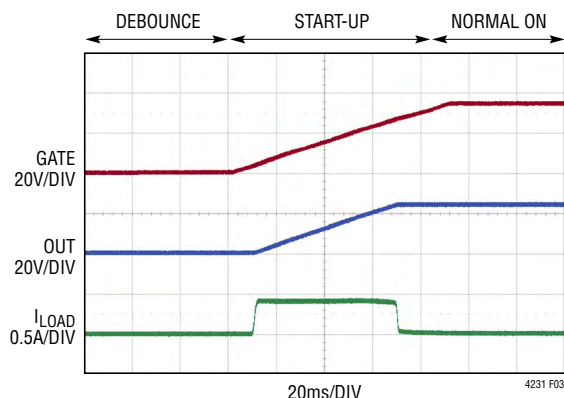

Figure 3. Inrush Control by Limiting  $V_{GATE}$  Slew

### Turn-Off Sequence

The MOSFET switch can be turned off by  $\overline{SHDN}$  going low, an OV/UV event, an overcurrent setting the current fault latch or IN dropping below its UVLO voltage. Under any of these conditions, STATUS pulls low and the MOSFET is turned off with a  $1mA$  current pulling down from GATE to GND.

In the back-to-back MOSFET configuration as shown in Figure 5, SOURCE will also be pulled to GND via the parasitic body diode between GATE and SOURCE, cutting off the load from IN. This configuration is suitable in power path control and reverse battery protection applications where IN is likely to go below GND.

In the single MOSFET configuration (Figure 1), the  $1mA$  pull-down from GATE to GND also discharges the load capacitor  $C_L$  to GND once GATE goes below SOURCE.

### Overcurrent Fault

The  $50mV$  circuit breaker threshold sets the maximum load current allowed under steady state conditions. However, the LTC4231 allows mild overcurrents during supply or load transients when  $\Delta V_{SENSE}$  momentarily exceeds  $50mV$  but stays below the  $80mV$  analog current limit threshold. For severe overcurrents when  $\Delta V_{SENSE}$  exceeds  $80mV$ , the analog current limit amplifier controls  $\Delta V_{GATE}$  to regulate  $\Delta V_{SENSE}$  to  $80mV$ . The durations of these transient overcurrents must be less than the circuit breaker delay ( $t_{CB}$ ) which can be adjusted using the capacitor  $C_T$  at the TIMER pin.

When  $\Delta V_{SENSE}$  exceeds  $50mV$ , the LTC4231 goes into overcurrent mode.  $C_T$  is charged with a  $50\mu A$  pull-up. If the overcurrent is transient and  $\Delta V_{SENSE}$  goes below  $50mV$  before TIMER reaches  $1.193V$ , the  $50\mu A$  pull-up on TIMER switches to a  $5\mu A$  pull-down. Multiple overcurrents with a duty cycle  $> 10\%$  can thus eventually integrate TIMER to  $1.193V$ . When TIMER reaches  $1.193V$ , the LTC4231 goes into current fault mode and sets an internal current fault latch. The external MOSFET will be cut off by a  $1mA$  pull-down from GATE to GND while STATUS pull-down is asserted.

The time in which LTC4231 stays in overcurrent mode before going into current fault mode is called the circuit breaker delay and is given by:

$$t_{CB} = C_T \cdot 24 \text{ [ms/}\mu\text{F]}$$

APPLICATIONS INFORMATION

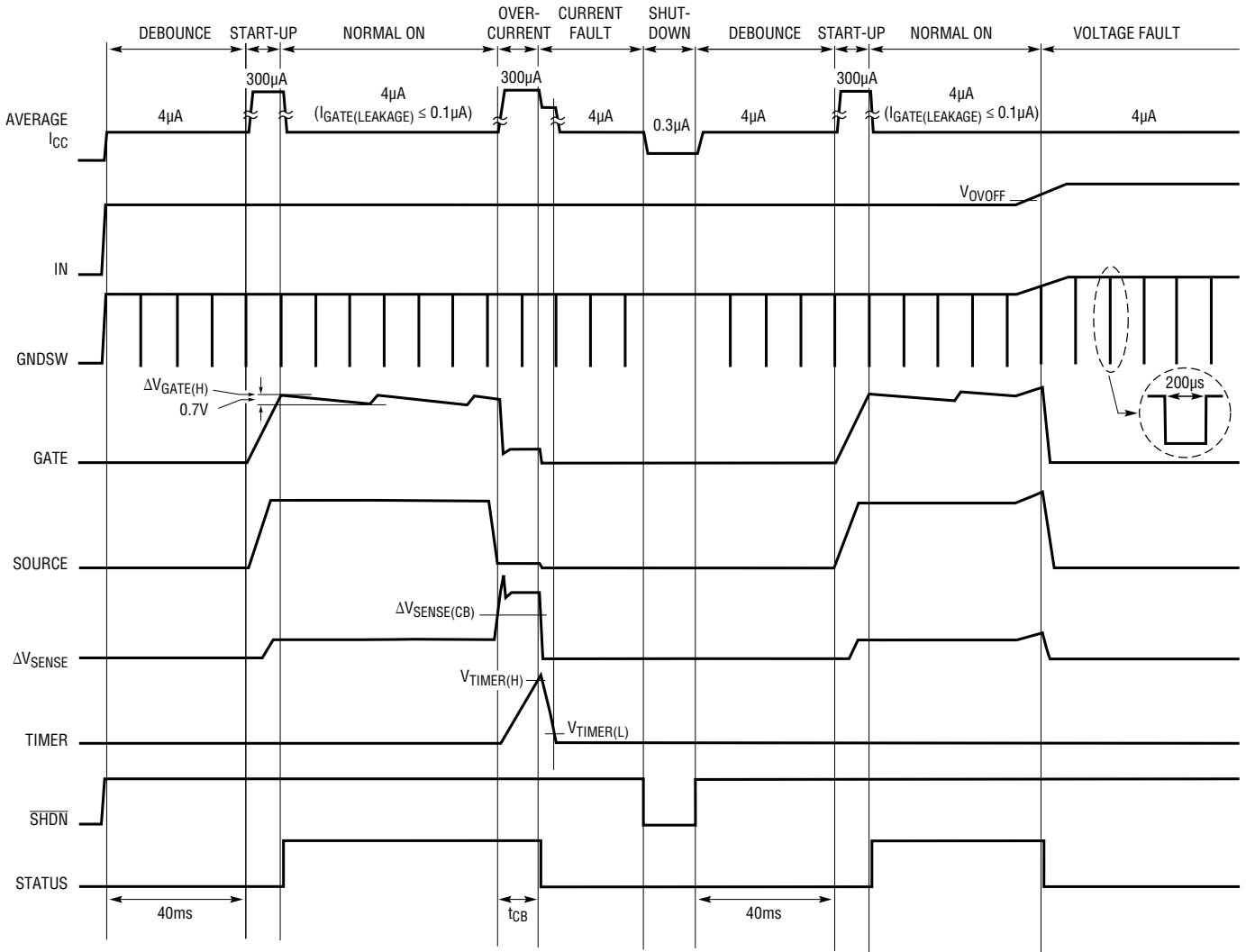

4231 F04

Figure 4. LTC4231-1 Overcurrent

## APPLICATIONS INFORMATION

### Auto-Retry vs Latchoff

During current fault mode, GATE is held low and TIMER is discharged to GND. Once  $TIMER < 0.1V$ , average  $I_{CC}$  goes to  $4\mu A$  and the internal current fault latch is ready to be reset. The LTC4231-2 (automatic retry) waits for a 500ms retry delay after which the internal current fault latch is reset and GATE ramps up to turn the MOSFET back on.

The LTC4231-1 (latchoff) version does not restart automatically. Pulling  $\overline{SHDN}$  low for  $>100\mu s$  will reset the internal current fault latch. When  $\overline{SHDN}$  goes high, GATE ramps up after a debounce cycle. Alternatively, IN can be pulled to GND for  $>100\mu s$  then cycled back up again. This UVLO event will reset the internal current fault latch and GATE ramps up after a debounce cycle. A UV/OV detected at IN also resets the internal current fault latch and GATE ramps up after a debounce delay.

### Analog Current Limit Loop Stability

The analog current limit loop on GATE is compensated by the parasitic gate capacitance of the external MOSFET. No further compensation components are normally required. If a small MOSFET with  $C_{ISS} \leq 1nF$  is chosen, an  $R_G$  and  $C_G$  compensation network connected at GATE may be required (Figure 1) to ensure stability. The resistor,  $R_G$ , connected in series with  $C_G$  accelerates the MOSFET gate recovery after a fast gate pull-down. The value of  $C_G$  should be  $\leq 100nF$ . An additional  $10\Omega$  resistor ( $R_5$  in Figure 1) should be added close to the MOSFET gate to prevent possible parasitic oscillation due to trace/wire inductance and capacitance.

### Monitor OV and UV Faults

When IN is above UVLO and  $\overline{SHDN}$  is high, an internal clock times a  $200\mu s$  strobe of the resistive divider at IN every 10ms. During this  $200\mu s$  strobe, the normally high impedance GND<sub>SW</sub> is connected to GND with an internal  $80\Omega$  switch and the comparators connected to UVH, UVL and OV are awakened from sleep mode. The comparators sense the voltages on the resistive divider, and their outputs are latched at the end of the strobe window.

If an OV or UV violation is detected, the STATUS pulls low and a 1mA pull-down will be activated between GATE and GND to turn off the external MOSFET. When GATE goes  $<1.2V$ , average  $I_{CC}$  drops to  $4\mu A$  as the LTC4231 goes into voltage fault mode. It stays in this mode until a subsequent IN strobe sees no OV/UV. The LTC4231 then re-starts after a debounce cycle.

Strobing the resistive divider reduces power consumption as the external resistors as well as the internal OV/UV comparators do not dissipate power in between strobes. For a 1M string of resistors used to monitor a  $V_{IN}$  of 24V, this strobing scheme reduces the current consumption from  $24\mu A$  to  $0.48\mu A$  as the strobing duty cycle is 2% ( $200\mu s/10ms$ ). The OV/UV comparators dissipate  $35\mu A$  during IN strobing. The 2% duty cycle reduces this to an average current of  $0.7\mu A$ . Note that the response time to an OV/UV event can be as long as 10ms.

The four resistors allow three thresholds to be configured. They are the UV rising threshold ( $V_{UVON}$ ), the UV falling threshold ( $V_{UVOFF}$ ) and the OV rising threshold ( $V_{OVOFF}$ ). The OV falling threshold is set by internal hysteresis to be 1.8% below the OV rising threshold. Using the comparator threshold as 0.795V and choosing appropriate values for  $R_{TOTAL}$  and  $R_4$ , the resistor values can be calculated as follows:

$$R_{TOTAL} = R_1 + R_2 + R_3 + R_4$$

$$R_4 = \left( \frac{0.795V}{V_{OVOFF}} \right) \cdot R_{TOTAL}$$

$$R_3 = \left( \frac{V_{OVOFF}}{V_{UVON}} - 1 \right) \cdot R_4$$

$$R_2 = \left( \frac{V_{UVON}}{V_{UVOFF}} - 1 \right) \cdot \left( \frac{V_{OVOFF}}{V_{UVON}} \right) \cdot R_4$$

$$R_1 = \left( \frac{V_{OVOFF}}{0.795V} - 1 \right) \cdot R_4 - R_3 - R_2$$

It is recommended that the total value of the resistor string be less than 2M and traces at UVH, UVL, and OV kept short to minimize parasitic capacitance and improve settling time.

## APPLICATIONS INFORMATION

### Reverse Input Protection

Negative voltages at IN can occur if a battery is plugged in backwards or a negative supply is inadvertently connected. Back-to-back N-channel MOSFETs can be used as in Figure 5 to prevent the negative voltage from passing to the output load.

IN, SENSE, GATE and SOURCE are protected against reverse inputs of up to  $-40V$ . When the LTC4231's reverse voltage comparators detect a negative voltage at SENSE, an

internal switch is activated to connect GATE to SENSE. The body diode of M1 pulls SOURCE to a diode above SENSE. Since M2 is off and its body diode is in the reverse blocking mode, the negative voltage is blocked by the  $V_{DS}$  of M2.

Figure 6 shows the waveforms when the application circuit in Figure 5 is hot plugged to  $-24V$ . Due to the parasitic inductance at IN, SENSE and GATE, the voltages ring significantly below  $-24V$ . The TransZorb helps to clamp the negative undershoot and a 40V MOSFET is selected for M2 to survive this undershoot.

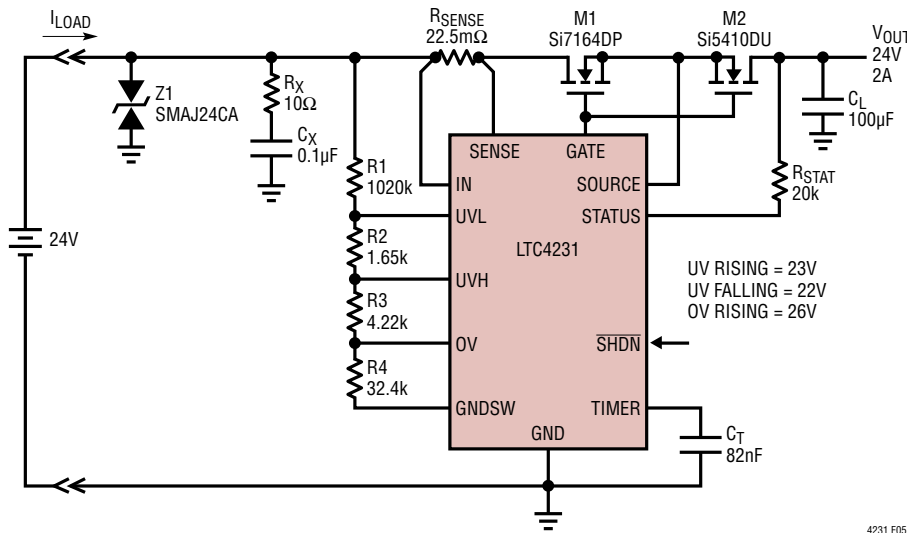

Figure 5. Back-to-Back MOSFETs Protect Against Reverse Input

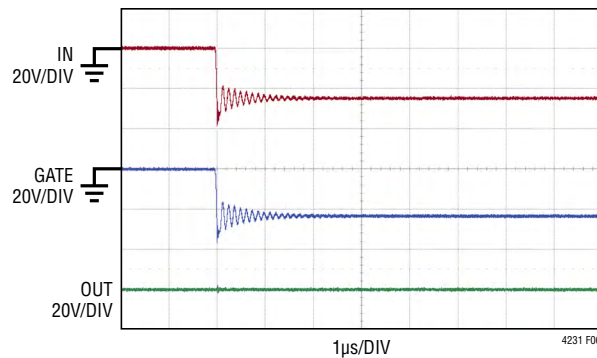

Figure 6. LTC4231 in Reverse Input Mode

## APPLICATIONS INFORMATION

### Achieving Low Quiescent Current

Table 1 summarizes the average  $I_{CC}$  of the various operating modes of the LTC4231.

**Table 1**

MODE	$I_{CC}$ (NORM)	$I_{CC}$ (MAX)
Start-Up or Overcurrent	300 $\mu$ A	600 $\mu$ A
Debounce, Normal On, Voltage or Current Fault	4 $\mu$ A	10 $\mu$ A
Shutdown	0.3 $\mu$ A	1 $\mu$ A
Reverse Input	-2.5mA	-5mA

To lower  $I_{CC}$  when GATE is high, the LTC4231 operates in normal on mode, where the charge pump delivers pulses of current to the GATE capacitance (either an external  $C_G$  or the parasitic capacitance of the external MOSFETs) to boost  $\Delta V_{GATE}$  to  $\Delta V_{GATE(H)}$  followed by sleep periods when the GATE capacitance holds up GATE. Leakage will cause  $\Delta V_{GATE}$  to droop during these sleep periods. When the  $\Delta V_{GATE}$  low comparator detects  $\Delta V_{GATE}$  drooping by more than 0.7V, it will activate the charge pump to boost  $\Delta V_{GATE}$  back to  $\Delta V_{GATE(H)}$  before returning to sleep mode. In addition to the  $\Delta V_{GATE}$  low comparator, there is a charge pump refresh timer that turns on the charge pump every 15ms to boost  $\Delta V_{GATE}$  back to  $\Delta V_{GATE(H)}$ . This timer is reset when the charge pump turns on.

When in charge pump sleep mode the LTC4231 consumes 2 $\mu$ A. When the charge pump is on to deliver a current pulse

to GATE,  $I_{CC}$  briefly goes up to 200 $\mu$ A. The amount of leakage at GATE ( $I_{GATE(LEAKAGE)}$ ) will determine the duty cycle of the charge pump. Figure 7 shows start-up and  $\Delta V_{GATE}$  regulation (with different  $I_{GATE(LEAKAGE)}$ ) waveforms from the Figure 5 application circuit.

As the average current delivered to GATE during the current pulse is around 15 $\mu$ A, the duty cycle of the charge pump for a  $I_{GATE(LEAKAGE)}$  of 0.1 $\mu$ A is  $0.1/15 = 0.67\%$ . The average current due to  $\Delta V_{GATE}$  regulation is then  $0.67\% \cdot 200\mu A = 1.3\mu A$ . When added to the average current due to OV/UV strobing (0.7 $\mu$ A) and charge pump sleep mode current (2 $\mu$ A), the average quiescent current of the LTC4231 during the normal on mode is  $1.3\mu A + 0.7\mu A + 2\mu A = 4\mu A$ . The normal on mode average supply current can be estimated using the formula:

$$I_{CC} = 2.7\mu A + 13.3 \cdot I_{GATE(LEAKAGE)}$$

The Typical Performance Characteristics section shows a graph of average  $I_{CC}$  (normal on) against  $I_{GATE(LEAKAGE)}$ .

### Shutdown Mode

When  $\overline{SHDN}$  goes low, STATUS pulls low and a 1mA pull-down will be activated between GATE and GND to cut off the external MOSFET. When GATE reaches <1.2V,  $I_{CC}$  drops to 0.3 $\mu$ A as the LTC4231 goes into shutdown mode. When  $\overline{SHDN}$  goes high, GATE ramps up after the 40ms debounce cycle. Figure 8 shows the application in Figure 5 going into shutdown mode.

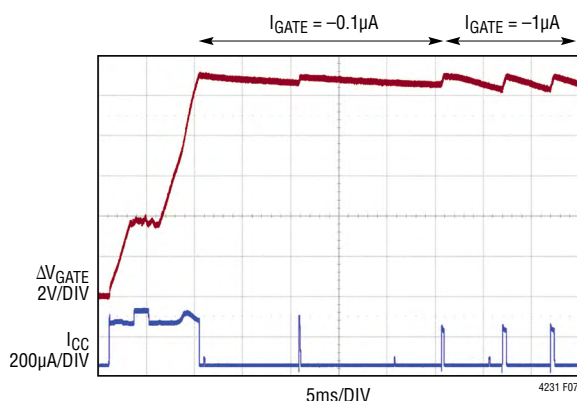

**Figure 7. Regulating  $\Delta V_{GATE}$  During Normal On Mode**

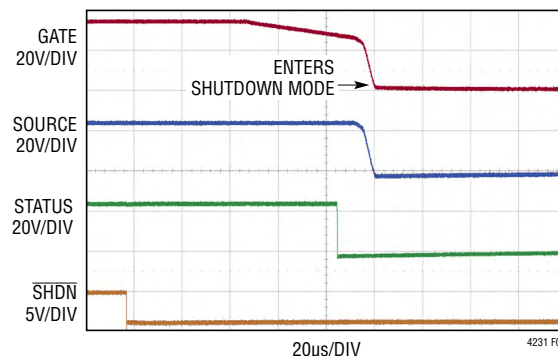

**Figure 8.  $\overline{SHDN}$  Going Low Activates Shutdown Mode**

## APPLICATIONS INFORMATION

### Supply Transient Protection

When the capacitances at the input and output are very small, rapid changes in current during an output short-circuit event can cause transients that exceed the 40V absolute maximum ratings of IN, SENSE and SOURCE. To minimize such spikes, use wider traces or heavier trace plating to reduce the power trace inductance. Also, bypass locally with a 10 $\mu$ F electrolytic and 0.1 $\mu$ F ceramic if hot plug inrush current is not a concern. Alternatively, clamp the input with a transient voltage suppressor (Z1 in Figure 5). A 10 $\Omega$ , 0.1 $\mu$ F snubber damps the response and reduces ringing ( $R_X$  and  $C_X$  in Figure 5).

### Design Example

As a design example, take the following specifications for the Figure 5 application circuit. The application is rated for a  $V_{IN}$  of 24V at 2A,  $C_L = 100\mu$ F. UV rising = 23V, UV falling = 22V, OV rising = 26V.

Sense resistor:

$$R_{SENSE} = \frac{\Delta V_{SENSE(CB)(MIN)}}{2A} = \frac{47mV}{2A} = 23.5m\Omega$$

Use  $R_{SENSE} = 22.5m\Omega$  for margin. Worst case analog current limit:

$$I_{LIMIT(MIN)} = \frac{\Delta V_{SENSE(ACL)(MIN)}}{22.5m\Omega} = \frac{65mV}{22.5m\Omega} = 2.89A$$

$$I_{LIMIT(MAX)} = \frac{\Delta V_{SENSE(ACL)(MAX)}}{22.5m\Omega} = \frac{90mV}{22.5m\Omega} = 4A$$

Calculate the worst case time it takes to charge up  $C_L$  in analog current limit:

$$t_{CHARGE(MAX)} = \frac{C_L \cdot V_{IN}}{I_{LIMIT(MIN)}} = \frac{100\mu F \cdot 24V}{2.89A} = 0.9ms$$

For inrush control using analog current limit,  $t_{CHARGE(MAX)}$  must be less than the circuit breaker delay ( $t_{CB}$ ) for a proper start-up.

The worst case power dissipation in MOSFET M1 occurs during a severe overcurrent fault when the current is controlled by analog current limit for the duration of  $t_{CB}$ :

$$P_{DISS} = V_{IN} \cdot I_{LIMIT(MAX)} = 24V \cdot 4A = 96W$$

The SOA (safe operating area) curve for the Si7164DP MOSFET shows that it can withstand 180W for 10ms. So choose a  $t_{CB}$  that is less than 10ms but higher than 0.9ms ( $t_{CHARGE(MAX)}$ ). In this case, use  $t_{CB} = 2ms$ .

$$C_T = \frac{t_{CB}}{24} = \frac{2ms}{24} = 0.082\mu F = 82nF$$

If a low inrush current ( $< \Delta V_{SENSE(CB)}$ ) is preferred, refer to the Figure 1 application circuit which uses a gate capacitor  $C_G$  to limit the inrush current. Choose  $I_{INRUSH} = 0.5A$  which is set using  $C_G$ :

$$C_G = \frac{C_L}{I_{INRUSH}} \cdot 10\mu A = \frac{1000\mu F}{0.5A} \cdot 10\mu A = 20nF$$

The time to charge up  $C_L$  with 0.5A is:

$$t_{CHARGE} = \frac{C_L \cdot V_{IN}}{I_{INRUSH}} = \frac{1000\mu F \cdot 24V}{0.5A} = 48ms$$

In this case  $t_{CHARGE}$  can be longer than  $t_{CB}$  with no start-up issue.

The average power dissipation in the MOSFET M1 during this start-up is:

$$P_{DISS} = \frac{V_{IN} \cdot I_{INRUSH}}{2} = \frac{24V \cdot 0.5A}{2} = 6W$$

The SOA of the MOSFET M1 must be evaluated to ensure that it can withstand 6W for 48ms. The SOA curve of the Si7120ADN withstands 10W for 360ms, satisfying the requirement.

The purpose of MOSFET M2 is to block the reverse path from OUT (drain of M2) to IN when GATE pulls to GND so that IN can go lower than OUT or even negative. Choose a 40V MOSFET to withstand a worse case reverse DC voltage of -24V. The Si5410DU offers a good choice with a maximum  $R_{DS(ON)}$  of 18m $\Omega$  at  $V_{GS} = 10V$ .

## APPLICATIONS INFORMATION

The IN monitoring resistors R1–R4 should be chosen to yield a total divider resistance of between 1M to 2M for both low power and good transient response. Using the formulas from the Monitor OV and UV Faults section, R1–R4 are calculated as follows (with all resistor values rounded up to the nearest 1% accurate standard values):

Choose  $R1 + R2 + R3 + R4 = 1000k\Omega$

$$R4 = \left( \frac{0.795V}{V_{OV\text{OFF}}} \right) \cdot 1000k\Omega$$

Choose  $R4 = 32.4k\Omega$  to give total divider resistance:  $R1 + R2 + R3 + R4 = 1060k\Omega$ .

$$R3 = \left( \frac{V_{OV\text{OFF}}}{V_{UV\text{ON}}} - 1 \right) \cdot R4 = \left( \frac{26V}{23V} - 1 \right) \cdot 32.4k\Omega = 4.22k\Omega$$

$$R2 = \left( \frac{V_{UV\text{ON}}}{V_{UV\text{OFF}}} - 1 \right) \cdot \left( \frac{V_{OV\text{OFF}}}{V_{UV\text{ON}}} \right) \cdot R4$$

$$= \left( \frac{23V}{22V} - 1 \right) \cdot \left( \frac{26V}{23V} \right) \cdot 32.4k\Omega = 1.65k\Omega$$

$$R1 = \left( \frac{V_{OV\text{OFF}}}{0.795V} - 1 \right) \cdot R4 - R3 - R2$$

$$= \left( \frac{26V}{0.795V} - 1 \right) \cdot 32.4k\Omega - 4.22k\Omega - 1.65k\Omega = 1020k\Omega$$

### Layout Considerations

To achieve accurate current sensing, a Kelvin connection for the sense resistor is recommended. The PCB layout for the resistor should be balanced and symmetrical to minimize wiring errors. In addition, the PCB layout for the sense resistors and the power MOSFETs should include good thermal management techniques for optimal device power dissipation. In Hot Swap applications where load currents can be high, narrow PCB tracks exhibit more resistance than wider tracks and operate at elevated temperatures. 1oz copper exhibits a sheet resistance of about 0.5mΩ/square. The minimum trace width for 1oz copper foil is 0.5mm per amp to make sure the trace stays at a reasonable temperature. Using 0.8mm per amp or wider is recommended. Thicker top and bottom copper such as 3oz or more can improve electrical conduction and reduce PCB trace dissipation.

If a resistor R5 (see Figure 1) is used, place it as close as possible to M1's gate input. This will limit the parasitic trace capacitance that leads to M1 self-oscillation. The transient voltage suppressor, Z1, when used, should be mounted close to the LTC4231 using short lead lengths. A recommended PCB layout for the sense resistor and back-to-back power MOSFETs is shown in Figure 9.

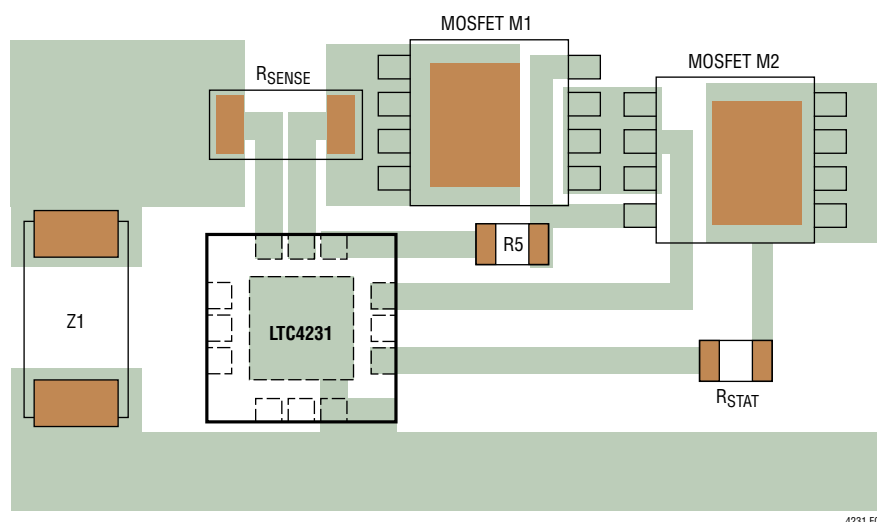

Figure 9. Recommended Layout



## PACKAGE DESCRIPTION

Please refer to <http://www.linear.com/designtools/packaging/> for the most recent package drawings.

**MS Package**  
**12-Lead Plastic MSOP**  
 (Reference LTC DWG # 05-08-1668 Rev A)

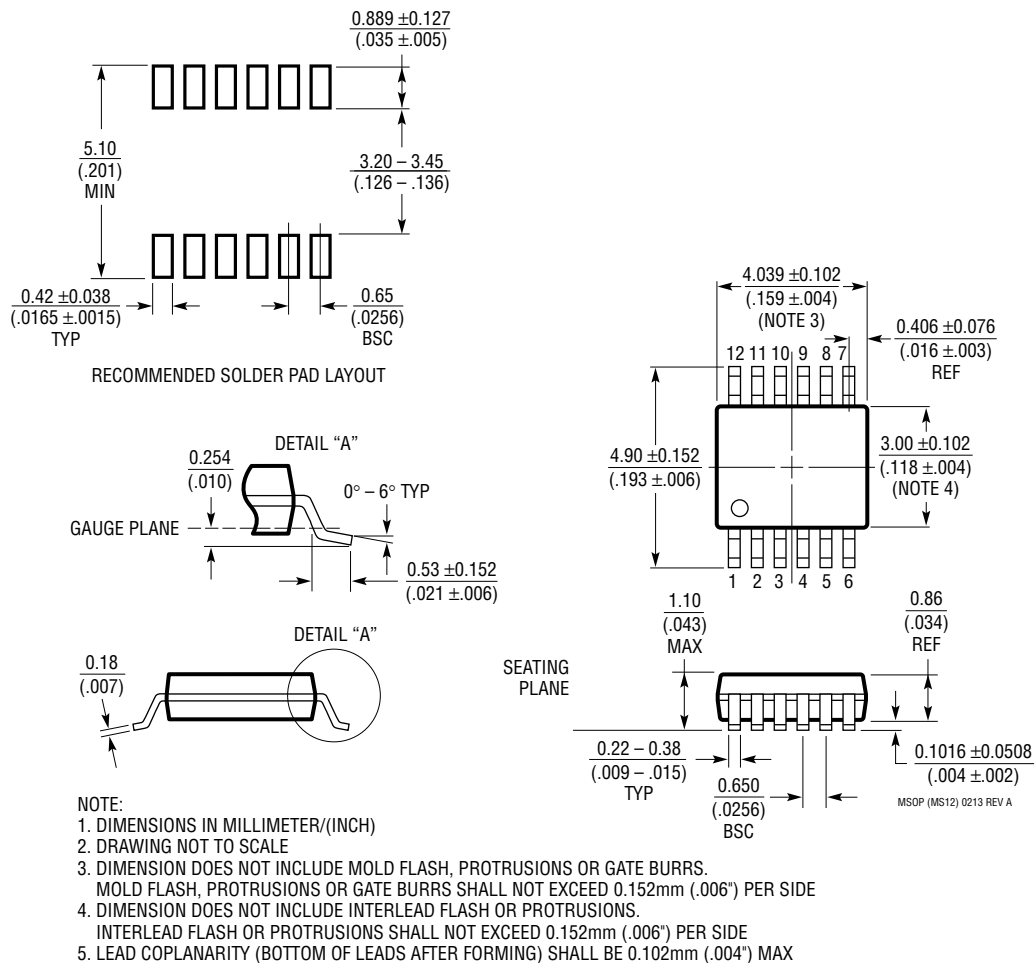

## PACKAGE DESCRIPTION

Please refer to <http://www.linear.com/designtools/packaging/> for the most recent package drawings.

**UD Package**  
**12-Lead Plastic QFN (3mm × 3mm)**  
 (Reference LTC DWG # 05-08-1855 Rev 0)

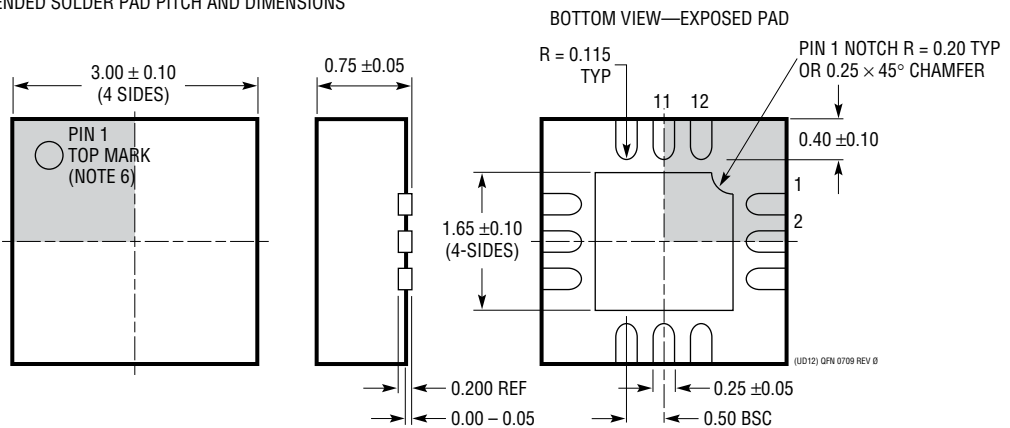
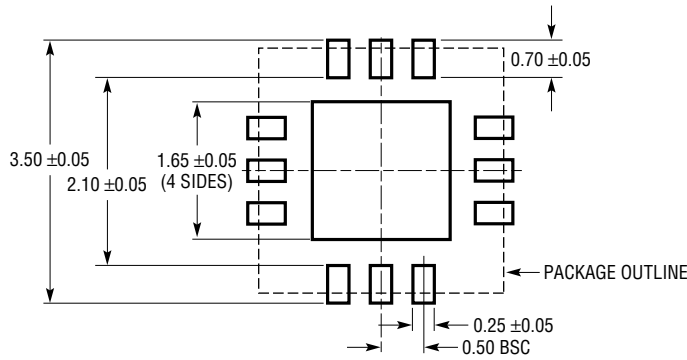

- NOTE:
1. DRAWING CONFORMS TO JEDEC PACKAGE OUTLINE MO-220 VARIATION (WEED-1)
  2. DRAWING NOT TO SCALE
  3. ALL DIMENSIONS ARE IN MILLIMETERS
  4. DIMENSIONS OF EXPOSED PAD ON BOTTOM OF PACKAGE DO NOT INCLUDE MOLD FLASH. MOLD FLASH, IF PRESENT, SHALL NOT EXCEED 0.15mm ON ANY SIDE
  5. EXPOSED PAD SHALL BE SOLDER PLATED
  6. SHADED AREA IS ONLY A REFERENCE FOR PIN 1 LOCATION ON THE TOP AND BOTTOM OF PACKAGE

## REVISION HISTORY

REV	DATE	DESCRIPTION	PAGE NUMBER
A	09/15	Added H-grade information Updated specifications: $V_{GATE(L)}$ , $I_{GATE(UP)}$ , $t_{D(ON)}$ , $t_{RETRY}$ , $t_{PERIOD}$ , $t_{SAMPLE}$ , $t_{CB}$	2, 3, 4 3,4

## TYPICAL APPLICATION

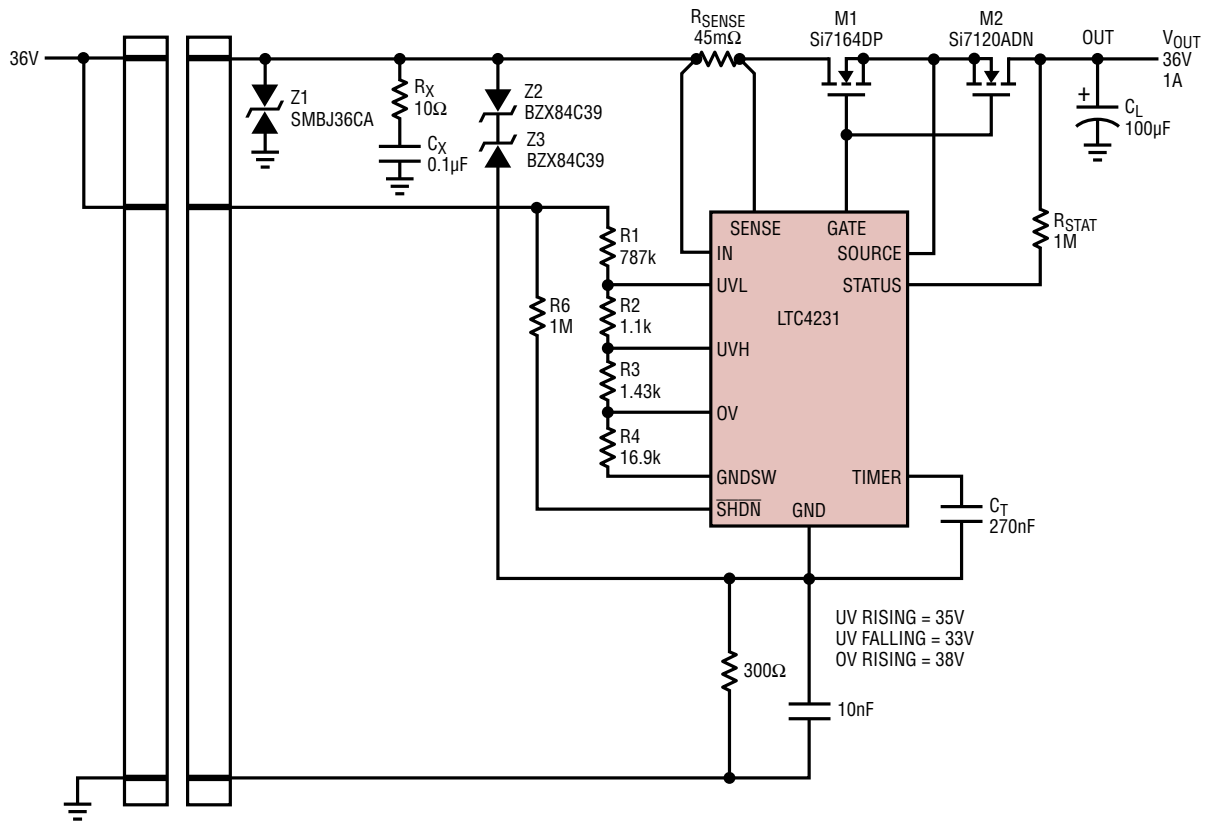

4231 F11

Figure 11. 36V Hot Swap Application with Reverse Protection

## RELATED PARTS

PART NUMBER	DESCRIPTION	COMMENTS
<a href="#">LTC4361</a>	Overshoot/Overcurrent Protection Controller	220μA I <sub>Q</sub> , 2.5V to 5.5V Operation, 80V Protection
<a href="#">LTC4365</a>	OV, UV and Reverse Supply Protection Controller	25μA I <sub>Q</sub> , 2.5V to 34V Operation, -40V Reverse Input
<a href="#">LTC4359</a>	Ideal Diode Controller with Reverse Input Protection	150μA I <sub>Q</sub> , 9μA in Shutdown, 4V to 80V Operation
<a href="#">LTC4364</a>	Surge Stopper/Hot Swap with Ideal Diode	370μA I <sub>CC</sub> , 4V to 80V Operation, -40V Reverse Input, -20V Reverse Output
<a href="#">LTC2960</a>	Nano-Current Dual Voltage Monitor	850nA I <sub>Q</sub> , 2.5V to 36V Operation, 1.5% Accuracy
<a href="#">LTC4229</a>	Ideal Diode and Hot Swap Controller	2.9V to 18V Operation, 2mA I <sub>IN</sub> , 0.5μs Ideal Diode Turn-On/Off
<a href="#">LTC4232</a>	5A Integrated Hot Swap Controller	Integrated 33mΩ MOSFET with Sense Resistor, 2.9V to 15V Operation
<a href="#">LTC2955</a>	Pushbutton On/Off Controller	Automatic Turn-On, 1.2μA I <sub>Q</sub> , 1.5V to 36V Operation
<a href="#">LTC4417</a>	Prioritized PowerPath™ Controller	28μA I <sub>Q</sub> , 2.5V to 36V Operation, -42V Reverse Input

## Looking for pricing, stock, or lifecycle information?

Click below to explore more details on WIN SOURCE:

 [View LTC4231IUD-1#PBF on WIN SOURCE](#)

 [Linear Technology](#) Information

## Optimize Your Supply Chain with WIN SOURCE Solutions

-  Global Sourcing Solution
-  Obsolete Management
-  Cost Control Management
-  Shortage Management
-  Alternative Solution
-  Excess Inventory Management