



**THE DATASHEET OF
LTC4078EDD-2#TRPBF**



Dual Input Li-Ion Battery Charger with Overvoltage Protection

FEATURES

- **22V Maximum Voltage for Wall Adapter and USB Inputs**
- **Charge Single-Cell Li-Ion Batteries from Wall Adapter and USB Inputs**
- **Automatic Input Power Detection and Selection**
- **Charge Current Programmable Up to 950mA from Wall Adapter Input**
- **Overvoltage Lockout for Wall Adapter and USB Inputs**
- **Battery Detection Input Disables Charger When No Battery is Present**
- No External MOSFET, Sense Resistor or Blocking Diode Needed
- Thermal Regulation Maximizes Charge Rate Without Risk of Overheating*
- Preset Charge Voltage with $\pm 0.6\%$ Accuracy
- Programmable Charge Current Termination
- 40 μ A USB Suspend Current in Shutdown
- Charge Status Output
- Automatic Recharge
- Available Without Trickle Charge (LTC4078X)
- Available in a Thermally Enhanced, Low Profile (0.75mm) 10-Lead (3mm \times 3mm) DFN Package

APPLICATIONS

- Cellular Telephones
- Handheld Computers
- Portable MP3 Players
- Digital Cameras

DESCRIPTION

The LTC[®]4078/LTC4078X are standalone linear chargers that are capable of charging a single-cell Li-Ion/Polymer battery from both wall adapter and USB inputs. The chargers can detect power at the inputs and automatically select the appropriate power source for charging.

No external sense resistor or blocking diode is required for charging due to the internal MOSFET architecture. The LTC4078/LTC4078X feature a maximum 22V rating for both wall adapter and USB inputs, although charging stops if the selected power source exceeds the overvoltage limit. Internal thermal feedback regulates the battery charge current to maintain a constant die temperature during high power operation or high ambient temperature conditions. The float voltage is fixed at 4.2V and the charge current is programmed with an external resistor. The LTC4078/LTC4078X terminate the charge cycle when the charge current drops below the programmed termination threshold after the final float voltage is reached.

Other features include battery present detection, automatic recharge, undervoltage lockout, charge status outputs, and “power present” status outputs to indicate the presence of wall adapter or USB power. The device is offered in a low profile (0.75mm) 3mm \times 3mm 10-lead DFN package.

LT, LT, LTC and LTM are registered trademarks of Linear Technology Corporation. All other trademarks are the property of their respective owners. *Protected by U.S. Patents including 6522118, 6700364.

TYPICAL APPLICATION

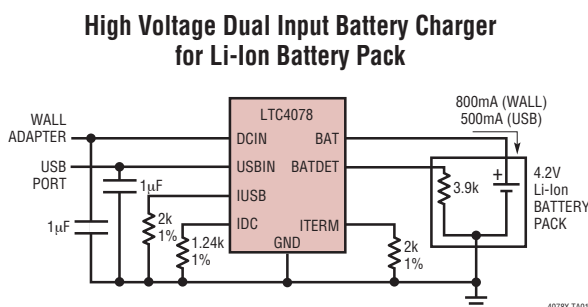

Charger Current vs Supply Voltage

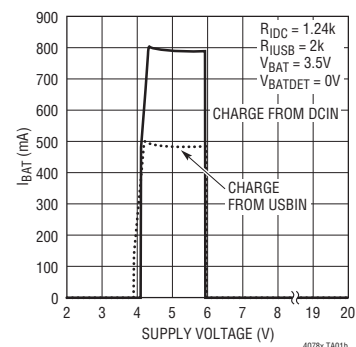

LTC4078/LTC4078X

ABSOLUTE MAXIMUM RATINGS

(Note 1)

Input Supply Voltage (DCIN, USBIN)	-0.3 to 22V
ENABLE, CHRG, PWR, BATDET, BAT	-0.3 to 6V
IDC, IUSB, ITERM Pin Current	1mA
DCIN, USBIN, BAT Pin Current.....	1A
BAT Short-Circuit Duration.....	Continuous
Maximum Junction Temperature.....	125°C
Operating Temperature Range (Note 2)....	-40°C to 85°C
Storage Temperature Range.....	-65°C to 125°C

PIN CONFIGURATION

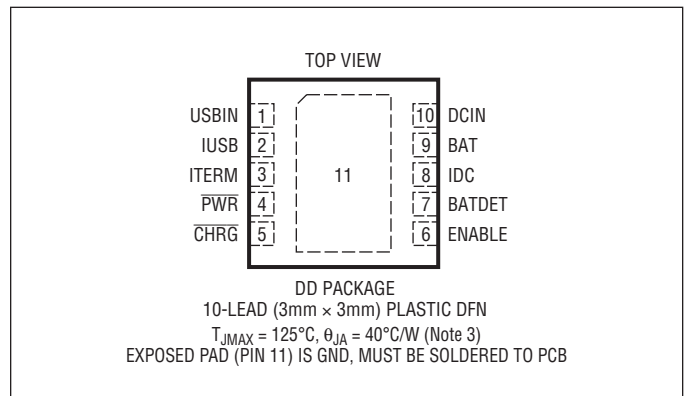

ORDER INFORMATION

LEAD FREE FINISH	TAPE AND REEL	PART MARKING	PACKAGE DESCRIPTION	TEMPERATURE RANGE
LTC4078XEDD#PBF	LTC4078XEDD#TRPBF	LCYP	10-Lead (3mm × 3mm) Plastic DFN	-40°C to 85°C
LTC4078EDD#PBF	LTC4078EDD#TRPBF	LDJY	10-Lead (3mm × 3mm) Plastic DFN	-40°C to 85°C

Consult LTC Marketing for parts specified with wider operating temperature ranges.

Consult LTC Marketing for information on non-standard lead based finish parts.

For more information on lead free part marking, go to: <http://www.linear.com/leadfree/>

For more information on tape and reel specifications, go to: <http://www.linear.com/tapeandreeel/>

ELECTRICAL CHARACTERISTICS

The ● denotes the specifications which apply over the full operating temperature range, otherwise specifications are at T_A = 25°C. V_{DCIN} = 5V, V_{USBIN} = 5V unless otherwise noted.

SYMBOL	PARAMETER	CONDITIONS	MIN	TYP	MAX	UNITS	
V _{DCIN}	Operating Supply Voltage		● 4.3		5.5	V	
V _{USBIN}	Operating Supply Voltage		● 4.3		5.5	V	
I _{DCIN}	DCIN Supply Current	Charge Mode (Note 4), R _{IDC} = 10k Standby Mode; Charge Terminated Shutdown Mode (ENABLE = 5V) Overvoltage Mode (V _{DCIN} = 10V)	●	350	800	μA	
			●	70	120	μA	
				40	80	μA	
				70	140	μA	
I _{USBIN}	USBIN Supply Current	Charge Mode (Note 5), R _{IUSB} = 10k, V _{DCIN} = 2V Standby Mode; Charge Terminated, V _{DCIN} = 2V Shutdown (V _{DCIN} = 2V, ENABLE = 0V) Overvoltage Mode (V _{USBIN} = 10V) V _{DCIN} > V _{USBIN}	●	350	800	μA	
			●	70	120	μA	
				40	80	μA	
				70	140	μA	
				23	40	μA	
V _{FLOAT}	Regulated Output (Float) Voltage	I _{BAT} = 1mA I _{BAT} = 1mA, 0°C < T _A < 85°C		4.185	4.2	4.215	V
				4.165	4.2	4.235	V
I _{BAT}	BAT Pin Current	R _{IDC} = 1.25k, Constant-Current Mode R _{IUSB} = 2.1k, Constant-Current Mode R _{IDC} = 10k or R _{IUSB} = 10k Standby Mode, Charge Terminated Shutdown Mode (Charger Disabled) Sleep Mode (V _{DCIN} = 0V, V _{USBIN} = 0V)	●	770	800	830	mA
			●	455	476	495	mA
			●	93	100	107	mA
				-7.5	-12		μA
				-7.5	-12		μA
				-7.5	-12		μA

4078xfb

ELECTRICAL CHARACTERISTICS

The ● denotes the specifications which apply over the full operating temperature range, otherwise specifications are at $T_A = 25^\circ\text{C}$. $V_{\text{DCIN}} = 5\text{V}$, $V_{\text{USBIN}} = 5\text{V}$ unless otherwise noted.

SYMBOL	PARAMETER	CONDITIONS	MIN	TYP	MAX	UNITS	
V_{IDC}	IDC Pin Regulated Voltage	Constant-Current Mode		1		V	
V_{IUSB}	IUSB Pin Regulated Voltage	Constant-Current Mode		1		V	
$I_{\text{TERMINATE}}$	Charge Current Termination Threshold	$R_{\text{ITERM}} = 1\text{k}$ $R_{\text{ITERM}} = 2\text{k}$ $R_{\text{ITERM}} = 10\text{k}$ $R_{\text{ITERM}} = 20\text{k}$	● ● ● ●	90 42 8 3.5	100 50 10 5	110 58 12 6.5	mA mA mA mA
I_{TRIKL}	Trickle Charge Current (Note 6)	$V_{\text{BAT}} < V_{\text{TRIKL}}$; $R_{\text{IDC}} = 1.25\text{k}$ $V_{\text{BAT}} < V_{\text{TRIKL}}$; $R_{\text{IUSB}} = 2.1\text{k}$		60 30	80 47.5	100 65	mA mA
V_{TRIKL}	Trickle Charge Threshold (Note 6)	V_{BAT} Rising Hysteresis		2.8	2.9 100	3	V mV
V_{UVDC}	DCIN Undervoltage Lockout Voltage	From Low to High Hysteresis		4	4.15 190	4.3	V mV
V_{UVUSB}	USBIN Undervoltage Lockout Voltage	From Low to High Hysteresis		3.8	3.95 170	4.1	V mV
V_{OVDC}	DCIN Overvoltage Lockout Voltage	From Low to High Hysteresis		5.8	6 185	6.2	V mV
V_{OVUSB}	USBIN Overvoltage Lockout Voltage	From Low to High Hysteresis		5.8	6 185	6.2	V mV
$V_{\text{ASD-DC}}$	$V_{\text{DCIN}} - V_{\text{BAT}}$ Lockout Threshold	V_{DCIN} from Low to High, $V_{\text{BAT}} = 4.2\text{V}$ V_{DCIN} from High to Low, $V_{\text{BAT}} = 4.2\text{V}$		70 10	120 40	170 70	mV mV
$V_{\text{ASD-USB}}$	$V_{\text{USBIN}} - V_{\text{BAT}}$ Lockout Threshold	V_{USBIN} from Low to High V_{USBIN} from High to Low		70 10	120 40	170 70	mV mV
V_{ENABLE}	ENABLE Input Threshold Voltage			0.6	0.9	1.2	V
R_{ENABLE}	ENABLE Pulldown Resistance		●	1	2	3.5	M Ω
V_{BDET}	BATDET Input Threshold Voltage	From Low to High		1.25	1.75	2	V
I_{BATDET}	BATDET Pull-Up Current	$V_{\text{BATDET}} = 0\text{V}$		2	4	6	μA
V_{BOC}	BATDET Open Circuit Voltage			4	4.2	4.4	V
V_{OL}	Output Low Voltage (CHRG, PWR)	$I_{\text{SINK}} = 5\text{mA}$			0.12	0.35	V
ΔV_{RECHRG}	Recharge Battery Threshold Voltage	$V_{\text{FLOAT}} - V_{\text{RECHRG}}$, $0^\circ\text{C} < T_A < 85^\circ\text{C}$		90	125	160	mV
t_{RECHRG}	Recharge Comparator Filter Time	V_{BAT} from High to Low		2.25	4.1	6.75	ms
$t_{\text{TERMINATE}}$	Termination Comparator Filter Time	I_{BAT} Drops Below Termination Threshold		1	1.6	2.4	ms
$R_{\text{ON-DC}}$	Power FET "ON" Resistance (Between DCIN and BAT)				600		m Ω
$R_{\text{ON-USB}}$	Power FET "ON" Resistance (Between USBIN and BAT)				700		m Ω
T_{LIM}	Junction Temperature in Constant-Temperature Mode				120		$^\circ\text{C}$

Note 1: Stresses beyond those listed under Absolute Maximum Ratings may cause permanent damage to the device. Exposure to any Absolute Maximum Rating condition for extended periods may affect device reliability and lifetime.

Note 2: The LTC4078/LTC4078X are guaranteed to meet the performance specifications from 0°C to 85°C . Specifications over the -40°C to 85°C operating temperature range are assured by design, characterization and correlation with statistical process controls.

Note 3: Failure to correctly solder the exposed backside of the package to the PC board will result in a thermal resistance much higher than $40^\circ\text{C}/\text{W}$. See Thermal Considerations.

Note 4: Supply current includes IDC and ITERM pin current (approximately $100\mu\text{A}$ each) but does not include any current delivered to the battery through the BAT pin.

Note 5: Supply current includes IUSB and ITERM pin current (approximately $100\mu\text{A}$ each) but does not include any current delivered to the battery through the BAT pin.

Note 6: This parameter is not applicable to the LTC4078X.

TYPICAL PERFORMANCE CHARACTERISTICS $T_A = 25^\circ\text{C}$, unless otherwise specified.

Regulated Output (Float) Voltage vs Charge Current

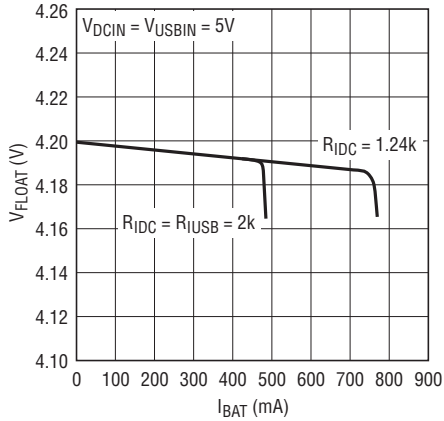

Regulated Output (Float) Voltage vs Temperature

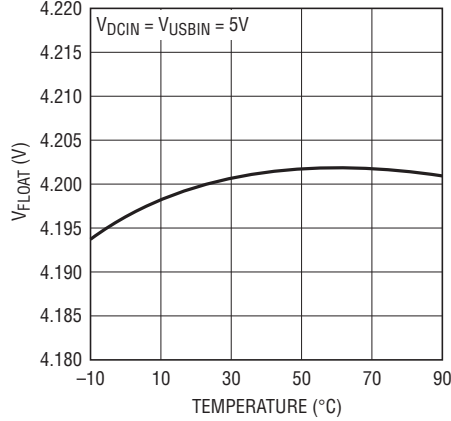

IDC Pin Voltage vs Temperature (Constant-Current Mode)

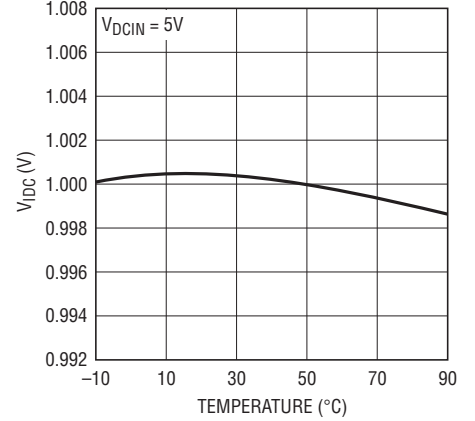

IUSB Pin Voltage vs Temperature (Constant-Current Mode)

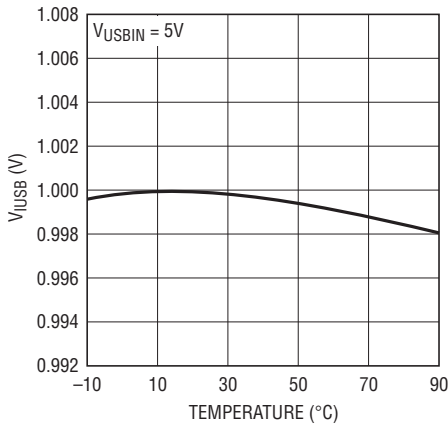

Charge Current vs IDC Pin Voltage

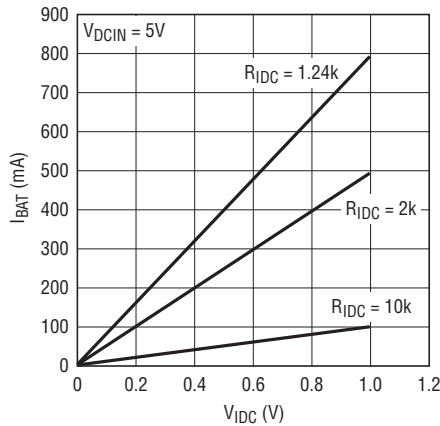

Charge Current vs IUSB Pin Voltage

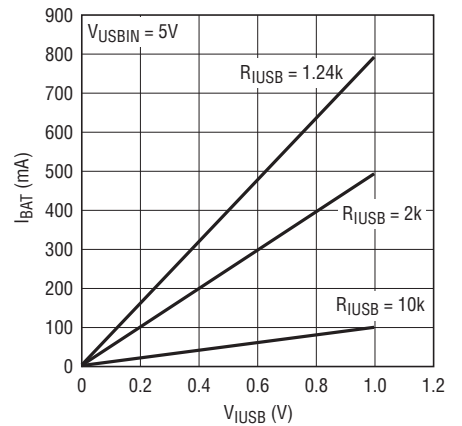

PWR Pin I-V Curve

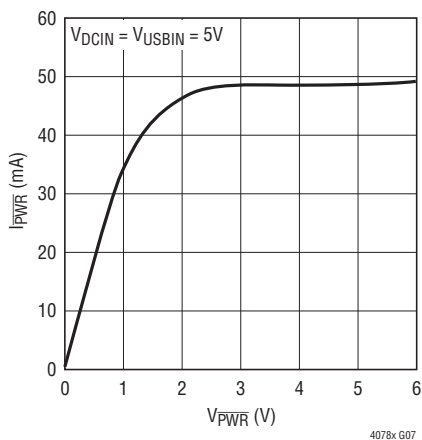

CHRG Pin I-V Curve

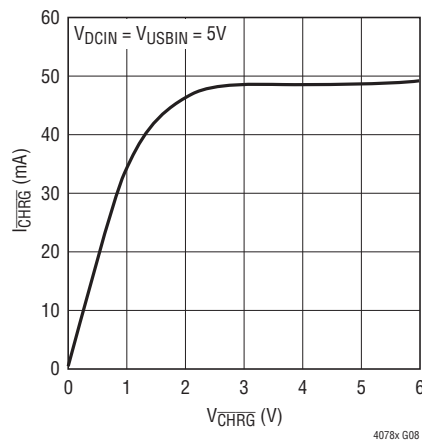

TYPICAL PERFORMANCE CHARACTERISTICS $T_A = 25^\circ\text{C}$, unless otherwise specified.

Charge Current vs Ambient Temperature

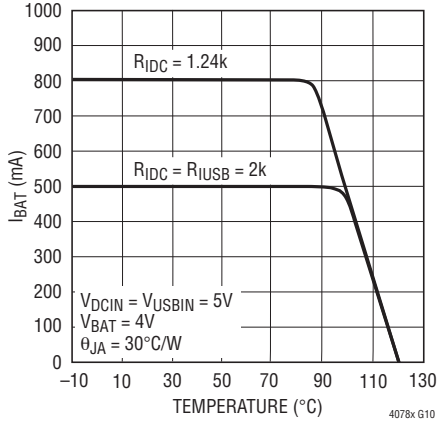

Charge Current vs Supply Voltage

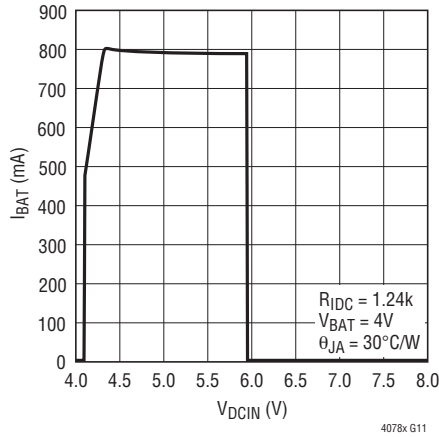

Charge Current vs Battery Voltage

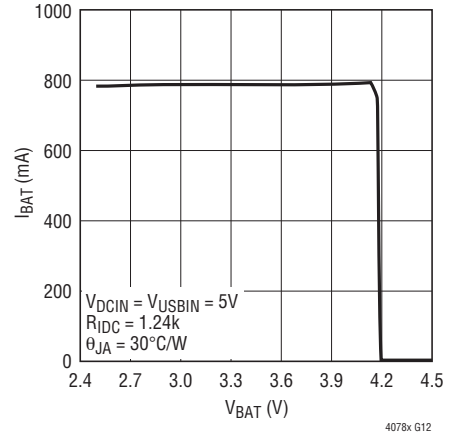

DCIN Power FET On-Resistance vs Temperature

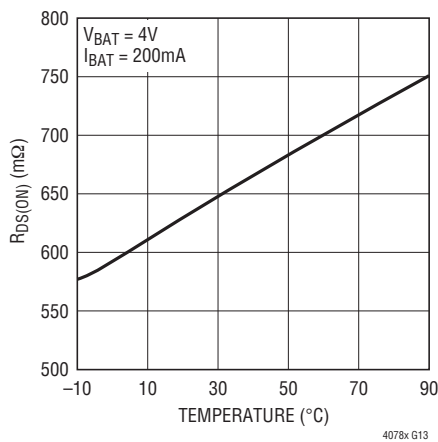

USBIN Power FET On-Resistance vs Temperature

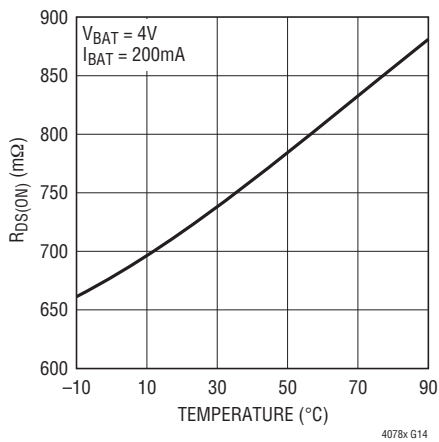

ENABLE Pin Threshold Voltage (On-to-Off) vs Temperature

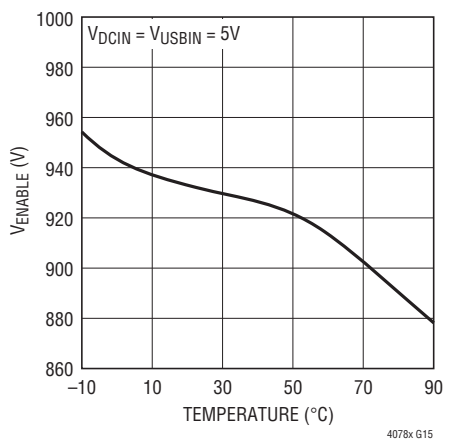

USBIN Shutdown Current vs Temperature

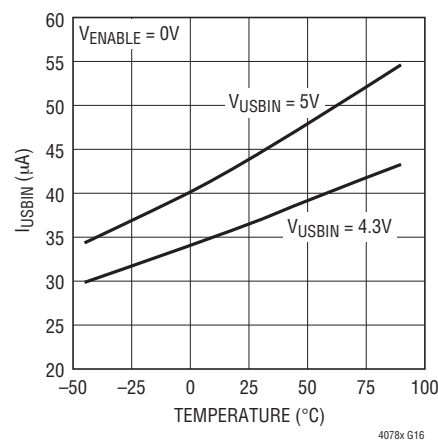

DCIN Shutdown Current vs Temperature

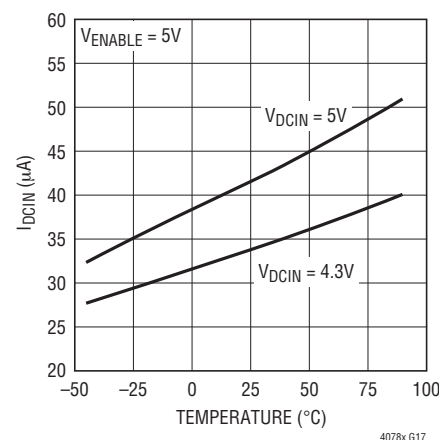

ENABLE Pin Pulldown Resistance vs Temperature

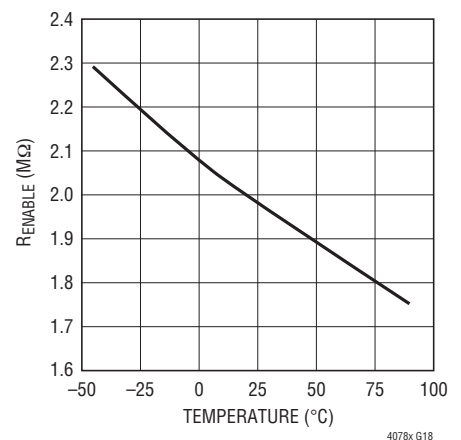

TYPICAL PERFORMANCE CHARACTERISTICS $T_A = 25^\circ\text{C}$, unless otherwise specified.

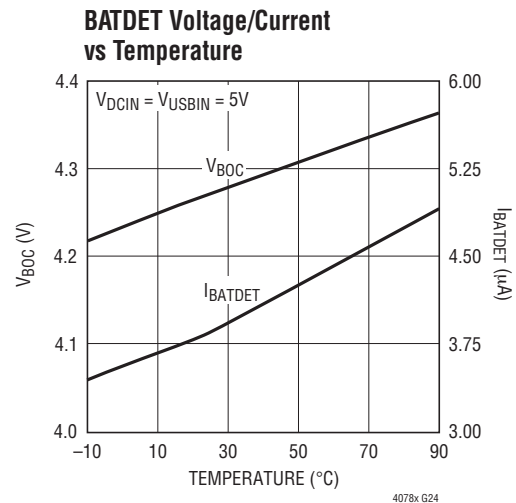
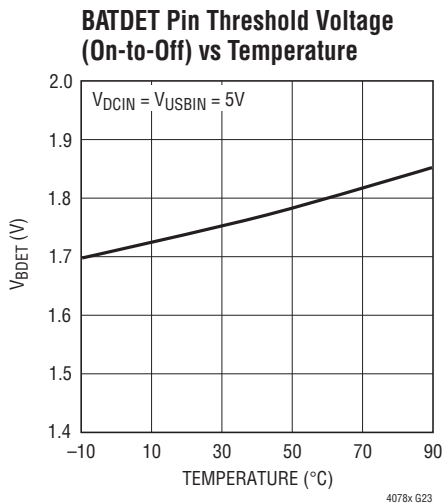
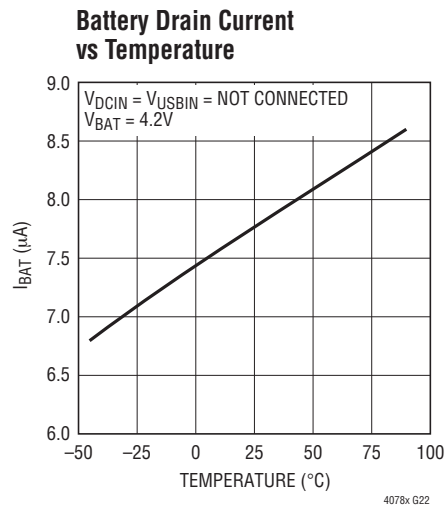
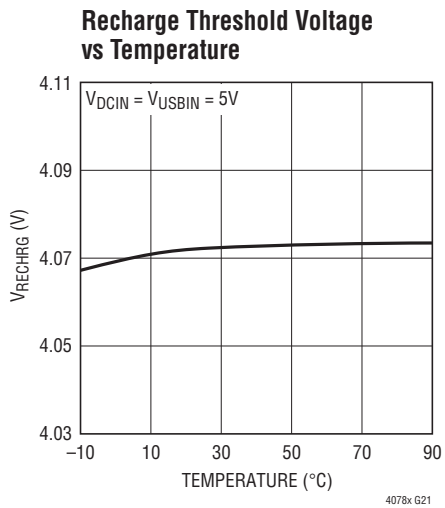
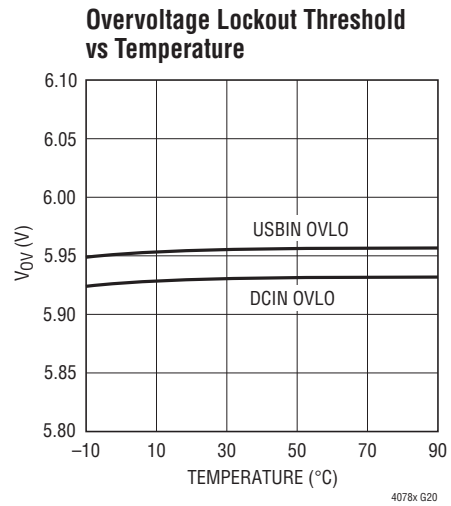
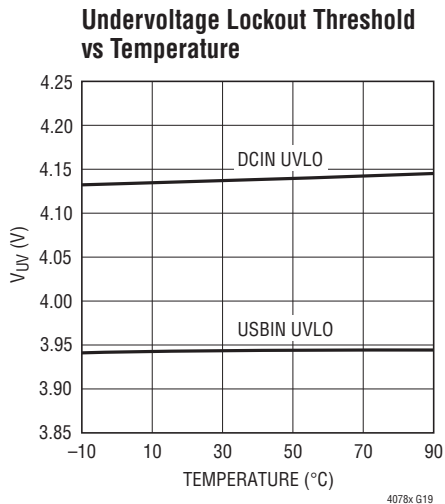

PIN FUNCTIONS

USBIN (Pin 1): USB Input Supply Pin. This input provides power to the battery charger assuming a voltage greater than V_{UVUSB} and less than V_{OVUSB} is present (typically 3.95V to 6V respectively). However, the DCIN input will take priority if a voltage greater than V_{UVDC} is present at DCIN (typically 4.15V). The USBIN input allows charge currents up to 850mA. This pin should be bypassed with a 1 μ F capacitor.

IUSB (Pin 2): Charge Current Program for USB Power. The charge current is set by connecting a resistor, R_{IUSB} , to ground. When charging in constant-current mode, this pin serves to 1V. The voltage on this pin can be used to measure the battery current delivered from the USB input using the following formula:

$$I_{BAT} = \frac{V_{IUSB}}{R_{IUSB}} \cdot 1000$$

ITERM (Pin 3): Termination Current Threshold Program. The termination current threshold, $I_{TERMINATE}$, is set by connecting a resistor, R_{ITERM} , to ground. $I_{TERMINATE}$ is set by the following formula:

$$I_{TERMINATE} = \frac{100V}{R_{ITERM}}$$

When the battery current, I_{BAT} , falls below the termination threshold, charging stops and the \overline{CHRG} output becomes high impedance. This pin is internally clamped to approximately 1.5V. Driving this pin to voltages beyond the clamp voltage should be avoided.

PWR (Pin 4): Open-Drain Power Supply Status Output. When the DCIN or USBIN pin voltage is valid to begin charging (i.e. when the supply is greater than the undervoltage lockout threshold, less than the overvoltage lockout threshold and at least 120mV above the battery terminal), the \overline{PWR} pin is pulled low by an internal N-channel MOSFET. Otherwise \overline{PWR} is high impedance. This output is capable of driving an LED.

CHRG (Pin 5): Open-Drain Charge Status Output. When the LTC4078/LTC4078X are charging, the \overline{CHRG} pin is pulled

low by an internal N-channel MOSFET. When the charge cycle is completed, \overline{CHRG} becomes high impedance. This output is capable of driving an LED.

ENABLE (Pin 6): Enable Input. When the LTC4078/LTC4078X are charging from the DCIN source, a logic low on this pin enables the charger. When the LTC4078/LTC4078X are charging from the USBIN source, a logic high on this pin enables the charger. If this input is left floating, an internal 2M Ω pulldown resistor defaults the LTC4078/LTC4078X to charge when a wall adapter is applied and to shut down if only the USB source is applied.

BATDET (Pin 7): Battery Detection Input. When the voltage on this pin falls below V_{BDET} (typically 1.75V), the charger is on and ready for charging a battery. If this input is left floating, an internal pull-up resistor will disable charging.

IDC (Pin 8): Charge Current Program for Wall Adapter Power. The charge current is set by connecting a resistor, R_{IDC} , to ground. When charging in constant-current mode, this pin serves to 1V. The voltage on this pin can be used to measure the battery current delivered from the DC input using the following formula:

$$I_{BAT} = \frac{V_{IDC}}{R_{IDC}} \cdot 1000$$

BAT (Pin 9): Battery Charger Output. This pin provides charge current to the battery and regulates the final float voltage to 4.2V.

DCIN (Pin 10): Wall Adapter Input Supply Pin. This input provides power to the battery charger assuming a voltage greater than V_{UVDC} and less than V_{OVDC} is present (typically 4.15V to 6V respectively). A valid voltage on the DCIN input will always take priority over the USBIN input. The DCIN input allows charge currents up to 950mA. This pin should be bypassed with a 1 μ F capacitor.

Exposed Pad (Pin 11): GND. The exposed backside of the package is ground and must be soldered to PC board ground for electrical connection and maximum heat transfer.

LTC4078/LTC4078X

BLOCK DIAGRAM

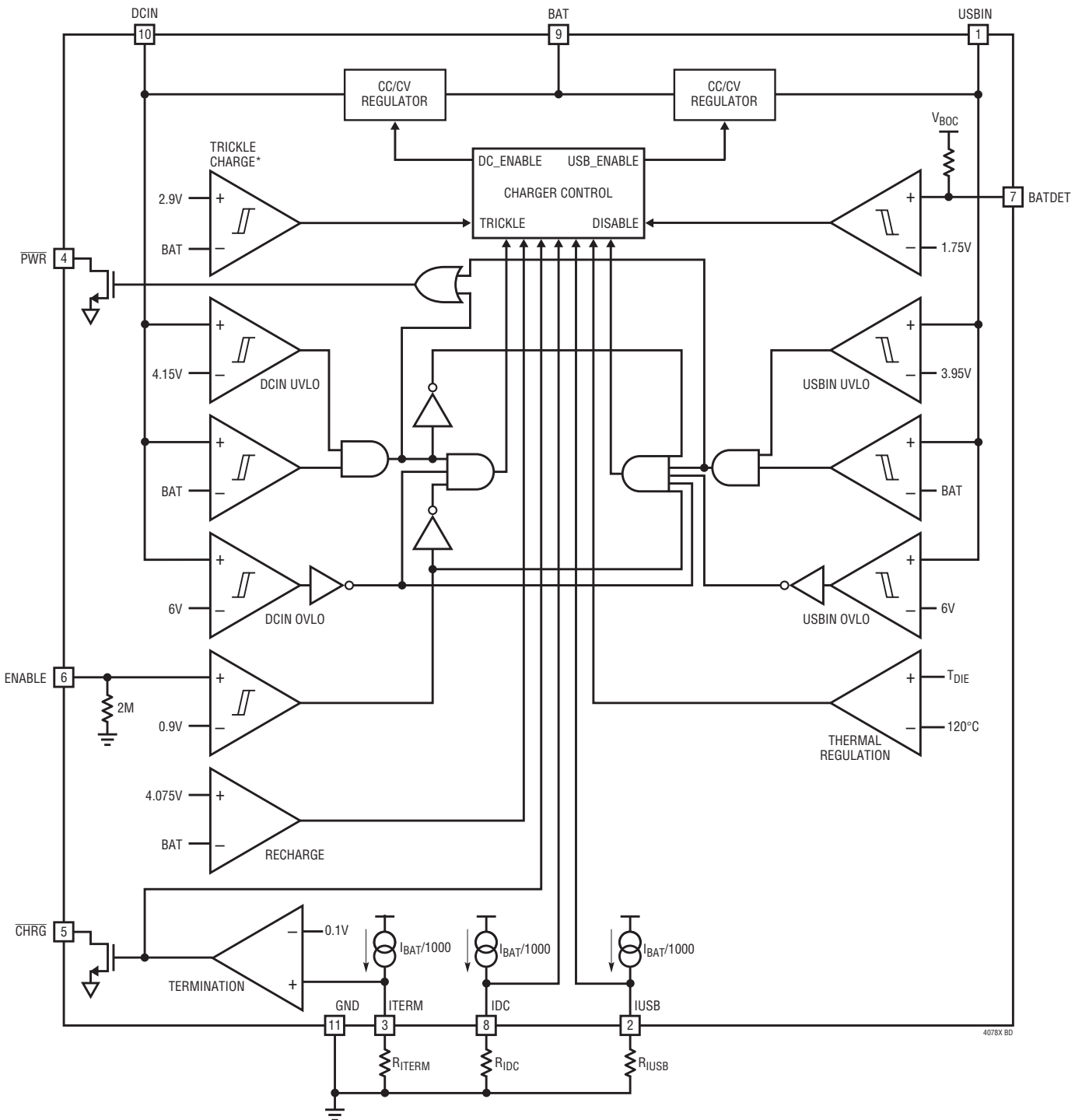

*TRICKLE CHARGE DISABLED ON THE LTC4078X

OPERATION

The LTC4078/LTC4078X are designed to efficiently manage charging of a single-cell lithium-ion battery from two separate power sources: a wall adapter and USB power bus. Using the constant-current/constant-voltage algorithm, the charger can deliver up to 950mA of charge current from the wall adapter supply or up to 850mA of charge current from the USB supply with a final float voltage accuracy of $\pm 0.6\%$. The LTC4078/LTC4078X have two internal P-channel power MOSFETs and thermal regulation circuitry. No blocking diodes or external sense resistors are required.

Power Source Selection

The LTC4078/LTC4078X can charge a battery from either the wall adapter input or the USB port input. The LTC4078/LTC4078X automatically sense the presence of voltage at each input. If both power sources are present, the LTC4078/LTC4078X default to the wall adapter source provided a valid voltage is present at the DCIN input. “Valid voltage” is defined as:

- Supply voltage is greater than the UVLO threshold and less than the OVLO threshold.
- Supply voltage is greater than the battery voltage by 40mV.

The open-drain power status output ($\overline{\text{PWR}}$) indicates which power source has been selected. Table 1 describes the behavior of this status output.

Programming and Monitoring Charge Current

The charge current delivered to the battery from the wall adapter or USB supply is programmed using a single resistor from the IDC or IUSB pin to ground. Both program resistors and charge currents (I_{CHRG}) are calculated using the following equations:

$$R_{\text{IDC}} = \frac{1000\text{V}}{I_{\text{CHRG-DC}}}, I_{\text{CHRG-DC}} = \frac{1000\text{V}}{R_{\text{IDC}}}$$

$$R_{\text{IUSB}} = \frac{1000\text{V}}{I_{\text{CHRG-USB}}}, I_{\text{CHRG-USB}} = \frac{1000\text{V}}{R_{\text{IUSB}}}$$

Charge current out of the BAT pin can be determined at any time by monitoring the IDC or IUSB pin voltage and applying the following equations:

$$I_{\text{BAT}} = \frac{V_{\text{IDC}}}{R_{\text{IDC}}} \cdot 1000, \text{ (charging from wall adapter)}$$

$$I_{\text{BAT}} = \frac{V_{\text{IUSB}}}{R_{\text{IUSB}}} \cdot 1000, \text{ (charging from USB supply)}$$

Battery Detection

By default, the BATDET pin is pulled high with an internal resistor, disabling the charger. To enable the charger, the BATDET pin must be pulled below the V_{BDET} threshold (typically 1.75V). An external resistor to ground less than 100k (typically 3.9k) located in the battery pack is used to detect battery presence.

Programming Charge Termination

The charge cycle terminates when the charge current falls below the programmed termination threshold level during constant-voltage mode. This threshold is set by connecting an external resistor, R_{ITERM} , from the ITERM pin to ground. The charge termination current threshold ($I_{\text{TERMINATE}}$) is set by the following equation:

$$R_{\text{ITERM}} = \frac{100\text{V}}{I_{\text{TERMINATE}}}, I_{\text{TERMINATE}} = \frac{100\text{V}}{R_{\text{ITERM}}}$$

The termination condition is detected using an internal filtered comparator to monitor the ITERM pin. When the ITERM pin voltage drops below 100mV* for longer than $t_{\text{TERMINATE}}$ (typically 1.6ms), charging is terminated. The charge current is latched off and the LTC4078/LTC4078X enter standby mode.

When charging, transient loads on the BAT pin can cause the ITERM pin to fall below 100mV for short periods of time before the DC charge current has dropped below the

*Any external sources that hold the ITERM pin above 100mV will prevent the LTC4078X from terminating a charge cycle.

OPERATION

programmed termination current. The 1.6ms filter time ($t_{\text{TERMINATE}}$) on the termination comparator ensures that transient loads of this nature do not result in premature charge cycle termination. Once the average charge current drops below the programmed termination threshold, the LTC4078/LTC4078X terminate the charge cycle and stops providing current out of the BAT pin. In this state, any load on the BAT pin must be supplied by the battery.

Low-Battery Charge Conditioning (Trickle Charge)

This feature ensures that near-dead batteries are gradually charged before applying full charge current. If the BAT pin voltage is below 2.9V, the LTC4078 supply 1/10th of the full charge current to the battery until the BAT pin rises above 2.9V. For example, if the charger is programmed to charge at 800mA from the wall adapter input and 500mA from the USB input, the charge current during trickle charge mode would be 80mA and 50mA, respectively.

The LTC4078X does not include the trickle charge feature; it outputs full charge current to the battery when the BAT pin voltage is below 2.9V. The LTC4078X are useful in applications where the trickle charge current may be insufficient to supply a load during low-battery voltage conditions.

Automatic Recharge

In standby mode, the charger sits idle and monitors the battery voltage using a comparator with a 4.1ms filter time (t_{RECHRG}). A charge cycle automatically restarts when the

battery voltage falls below 4.075V (which corresponds to approximately 80% to 90% battery capacity). This ensures that the battery is kept at, or near, a fully charged condition and eliminates the need for periodic charge cycle initiations.

Manual Shutdown

The ENABLE pin has a 2M Ω pulldown resistor to GND. The definition of this pin depends on which source is supplying power. When the wall adapter input is supplying power, logic low enables the charger and logic high disables it (the pulldown defaults the charger to the charging state). The opposite is true when the USB input is supplying power; logic low disables the charger and logic high enables it (the default is the shutdown state).

The DCIN input draws 40 μ A when the charger is in shutdown mode. The USBIN input draws 40 μ A during shutdown if no voltage is applied to DCIN, but draws only 23 μ A when V_{DCIN} provides valid voltage (see Table 1).

Status Indicators

The charge status open-drain output ($\overline{\text{CHRG}}$) has two states: pulldown and high impedance. The pulldown state indicates that the LTC4078/LTC4078X are in a charge cycle. Once the charge cycle has terminated or the LTC4078/LTC4078X are disabled, the pin state becomes high impedance.

The power supply status open-drain output ($\overline{\text{PWR}}$) has two states: pulldown and high impedance. The pulldown state indicates that power is present at either DCIN or USBIN.

Table 1. Power Source Selection ($V_{\text{BATDET}} < 1.75\text{V}$)

ENABLE	$V_{\text{USBIN}} < 3.95\text{V}$ or $V_{\text{USBIN}} < \text{BAT} + 50\text{mV}$		$6\text{V} > V_{\text{USBIN}} > 3.95\text{V}$ and $V_{\text{USBIN}} > \text{BAT} + 50\text{mV}$		$22\text{V} > V_{\text{USBIN}} > 6\text{V}$	
	HIGH	LOW or No Connect	HIGH	LOW or No Connect	HIGH	LOW or No Connect
$V_{\text{DCIN}} < 4.15\text{V}$ or $V_{\text{DCIN}} < \text{BAT} + 50\text{mV}$	No Charging. PWR: Hi-Z CHRG: Hi-Z	No Charging. PWR: Hi-Z CHRG: Hi-Z	Charging from USBIN source. PWR: LOW CHRG: LOW	No Charging. PWR: LOW CHRG: Hi-Z	No Charging. PWR: Hi-Z CHRG: Hi-Z	No Charging. PWR: Hi-Z CHRG: Hi-Z
$6\text{V} > V_{\text{DCIN}} > 4.15\text{V}$ and $V_{\text{DCIN}} > \text{BAT} + 50\text{mV}$	No Charging. PWR: LOW CHRG: Hi-Z	Charging from DCIN source. PWR: LOW CHRG: LOW	No Charging. PWR: LOW CHRG: Hi-Z	Charging from DCIN source. PWR: LOW CHRG: LOW	No Charging. PWR: LOW CHRG: Hi-Z	Charging from DCIN source. PWR: LOW CHRG: LOW
$22\text{V} > V_{\text{DCIN}} > 6\text{V}$	No Charging. PWR: Hi-Z CHRG: Hi-Z	No Charging. PWR: Hi-Z CHRG: Hi-Z	No Charging. PWR: LOW CHRG: Hi-Z	No Charging. PWR: LOW CHRG: Hi-Z	No Charging. PWR: Hi-Z CHRG: Hi-Z	No Charging. PWR: Hi-Z CHRG: Hi-Z

OPERATION

This output is strong enough to drive an LED. If no valid voltage is applied at either pin, the $\overline{\text{PWR}}$ pin is high impedance, indicating that the LTC4078/LTC4078X lack valid input voltage (see Table 1) to charge the battery.

Thermal Limiting

An internal thermal feedback loop reduces the programmed charge current if the die temperature attempts to rise above a preset value of approximately 120°C. This feature protects

the LTC4078/LTC4078X from excessive temperature and allows the user to push the limits of the power handling capability of a given circuit board without risk of damaging the device. The charge current can be set according to typical (not worst-case) ambient temperature with the assurance that the charger will automatically reduce the current in worst case conditions. DFN package power considerations are discussed further in the Applications Information section.

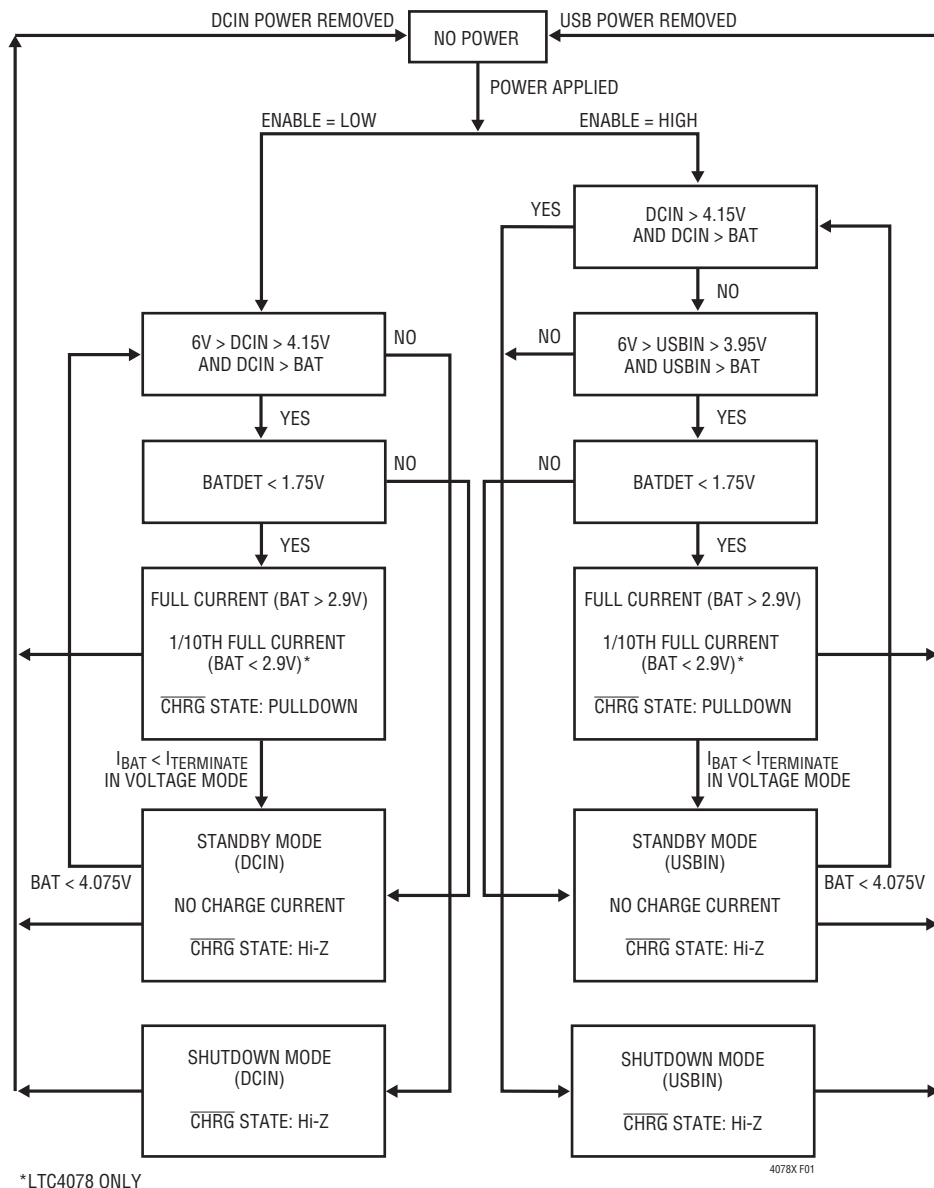

Figure 1. LTC4078 State Diagram of a Charge Cycle

APPLICATIONS INFORMATION

Using a Single Charge Current Program Resistor

The LTC4078/LTC4078X can program the wall adapter charge current and USB charge current independently using two program resistors, R_{IDC} and R_{IUSB} . Figure 2 shows a charger circuit that sets the wall adapter charge current to 800mA and the USB charge current to 500mA.

In applications where the programmed wall adapter charge current and USB charge current are the same, a single program resistor can be used to set both charge currents. Figure 3 shows a charger circuit that uses one charge current program resistor.

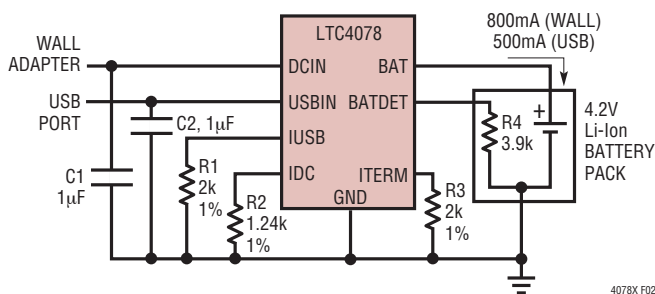

Figure 2. Dual Input Charger with Independent Charge Currents

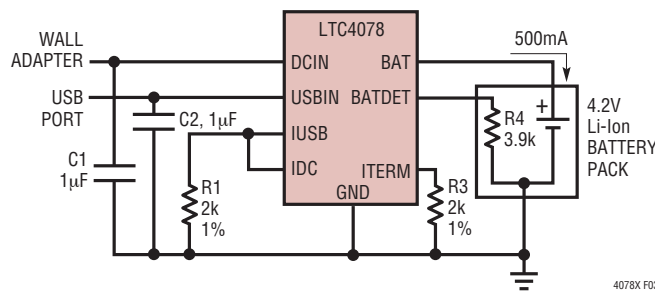

Figure 3. Dual Input Charger Circuit. The Wall Adapter Charge Current and USB Charge Current Are Both Programmed to Be 500mA

In this circuit, the programmed charge current from both the wall adapter supply is the same value as the programmed charge current from the USB supply:

$$I_{\text{CHRG-DC}} = I_{\text{CHRG-USB}} = \frac{1000V}{R_{\text{ISET}}}$$

Stability Considerations

The constant-voltage mode feedback loop is stable without any compensation provided a battery is connected to the charger output. However, a 1µF capacitor with a 1Ω series resistor is recommended at the BAT pin to keep the ripple voltage low when the battery is disconnected.

When the charger is in constant-current mode, the charge current program pin (IDC or IUSB) is in the feedback loop, not the battery. The constant-current mode stability is affected by the impedance at the charge current program pin. With no additional capacitance on this pin, the charger is stable with program resistor values as high as 20k ($I_{\text{CHRG}} = 50\text{mA}$); however, additional capacitance on these nodes reduces the maximum allowed program resistor.

Power Dissipation

When designing the battery charger circuit, it is not necessary to design for worst-case power dissipation scenarios because the LTC4078/LTC4078X automatically reduce the charge current during high power conditions. The conditions that cause the LTC4078/LTC4078X to reduce charge current through thermal feedback can be approximated by considering the power dissipated in the IC. Most of the power dissipation is generated from the internal charger MOSFET. Thus, the power dissipation is calculated to be:

$$P_D = (V_{\text{IN}} - V_{\text{BAT}}) \cdot I_{\text{BAT}}$$

P_D is the dissipated power, V_{IN} is the input supply voltage (either DCIN or USBIN), V_{BAT} is the battery voltage and I_{BAT} is the charge current. The approximate ambient temperature at which the thermal feedback begins to protect the IC is:

$$T_A = 120^\circ\text{C} - P_D \cdot \theta_{\text{JA}}$$

$$T_A = 120^\circ\text{C} - (V_{\text{IN}} - V_{\text{BAT}}) \cdot I_{\text{BAT}} \cdot \theta_{\text{JA}}$$

Example: An LTC4078/LTC4078X operating from a 5V wall adapter (on the DCIN input) is programmed to supply 800mA full-scale current to a discharged Li-Ion battery with a voltage of 3.3V.

APPLICATIONS INFORMATION

Assuming θ_{JA} is $40^{\circ}\text{C}/\text{W}$ (see Thermal Considerations), the ambient temperature at which the LTC4078/LTC4078X will begin to reduce the charge current is approximately:

$$T_A = 120^{\circ}\text{C} - (5\text{V} - 3.3\text{V}) \cdot (800\text{mA}) \cdot 40^{\circ}\text{C}/\text{W}$$

$$T_A = 120^{\circ}\text{C} - 1.36\text{W} \cdot 40^{\circ}\text{C}/\text{W} = 120^{\circ}\text{C} - 54.4^{\circ}\text{C}$$

$$T_A = 65.6^{\circ}\text{C}$$

The LTC4078/LTC4078X can be used above 70.6°C ambient, but the charge current will be reduced from 800mA. The approximate current at a given ambient temperature can be approximated by:

$$I_{\text{BAT}} = \frac{120^{\circ}\text{C} - T_A}{(V_{\text{IN}} - V_{\text{BAT}}) \cdot \theta_{JA}}$$

Using the previous example with an ambient temperature of 75°C , the charge current will be reduced to approximately:

$$I_{\text{BAT}} = \frac{120^{\circ}\text{C} - 75^{\circ}\text{C}}{(5\text{V} - 3.3\text{V}) \cdot 40^{\circ}\text{C}/\text{W}} = \frac{45^{\circ}\text{C}}{68^{\circ}\text{C}/\text{A}}$$

$$I_{\text{BAT}} = 662\text{mA}$$

It is important to remember that LTC4078/LTC4078X applications do not need to be designed for worst-case thermal conditions, since the IC will automatically reduce power dissipation when the junction temperature reaches approximately 120°C .

Thermal Considerations

In order to deliver maximum charge current under all conditions, it is critical that the exposed metal pad on the backside of the LTC4078/LTC4078X DFN package is properly soldered to the PC board ground. When correctly soldered to a 2500mm^2 double sided 1oz copper board, the LTC4078/LTC4078X has a thermal resistance of approximately $40^{\circ}\text{C}/\text{W}$. Failure to make thermal contact between the exposed pad on the backside of the package and the copper board will result in thermal resistances far greater than $40^{\circ}\text{C}/\text{W}$. As an example, a correctly soldered

LTC4078/LTC4078X can deliver over 800mA to a battery from a 5V supply at room temperature. Without a good backside thermal connection, this number would drop to much less than 500mA.

Input Capacitor Selection

When an input supply is connected to a portable product, the inductance of the cable and the high-Q ceramic input capacitor form an L-C resonant circuit. While the LTC4078/LTC4078X are capable of withstanding input voltages as high as 22V, if the input cable does not have adequate mutual coupling or if there is not much impedance in the cable, it is possible for the voltage at the input of the product to reach as high as 2x the input voltage before it settles out. To prevent excessive voltage from damaging the LTC4078/LTC4078X during a hot insertion, it is best to have a low voltage coefficient capacitor at the input pins to the LTC4078/LTC4078X. This is achievable by selecting an X5R or X7R ceramic capacitor that has a higher voltage rating than that required for the application. For example, if the maximum expected input voltage is 15V, a 25V X5R $1\mu\text{F}$ capacitor would be a better choice than the smaller 16V X5R capacitor. Note that no charging will occur with 15V in.

Using a tantalum capacitor or an aluminum electrolytic capacitor for input bypassing, or paralleling with a ceramic capacitor will also reduce voltage overshoot during a hot insertion. Ceramic capacitors with Y5V or Z5U dielectrics are not recommended.

Alternatively, the following soft connect circuit can be employed (as shown in Figure 4).

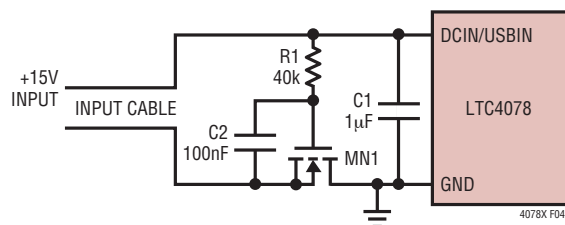

Figure 4. Input Soft Connect Circuit

APPLICATIONS INFORMATION

In this circuit, capacitor C2 holds MN1 off when the cable is first connected. Eventually C2 begins to charge up to the USB input voltage applying increasing gate drive to MN1. The long time constant of R1 and C1 prevent the current from rapidly building up in the cable, thus dampening out any resonant overshoot.

Reverse Polarity Input Voltage Protection

In some applications, protection from reverse polarity voltage on the input supply pins is desired. With sufficient

supply voltage, a series blocking diode can be used. In other cases where the voltage drop must be kept low, a P-channel MOSFET can be used (as shown in Figure 5).

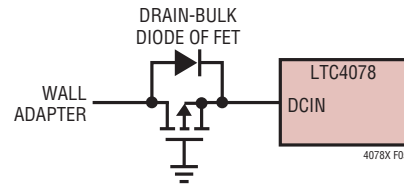
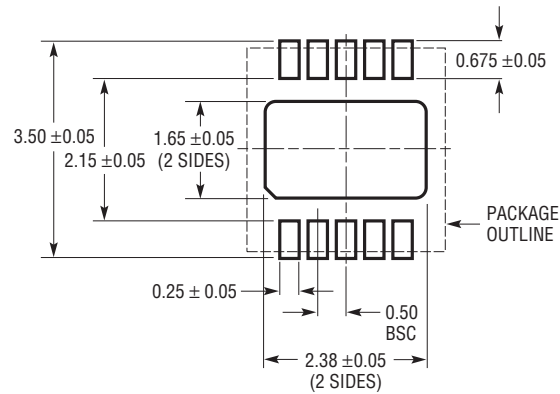

Figure 5. Low Loss Reverse Polarity Protection

PACKAGE DESCRIPTION

DD Package 10-Lead Plastic DFN (3mm × 3mm) (Reference LTC DWG # 05-08-1699)



RECOMMENDED SOLDER PAD PITCH AND DIMENSIONS

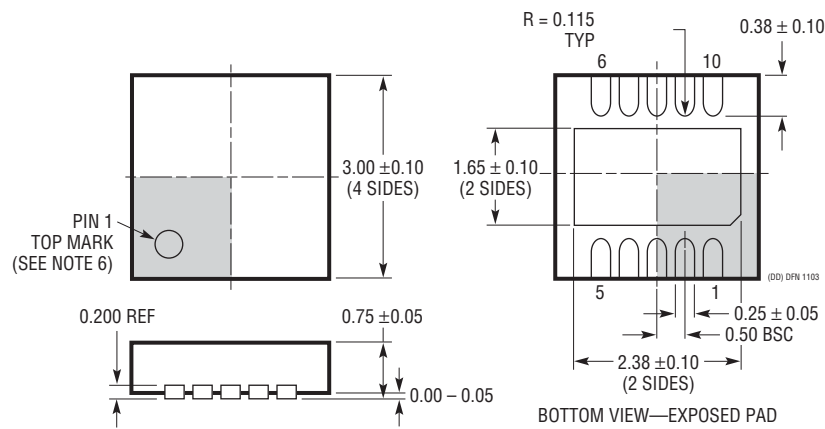

NOTE:

1. DRAWING TO BE MADE A JEDEC PACKAGE OUTLINE MO-229 VARIATION OF (WEED-2). CHECK THE LTC WEBSITE DATA SHEET FOR CURRENT STATUS OF VARIATION ASSIGNMENT
2. DRAWING NOT TO SCALE
3. ALL DIMENSIONS ARE IN MILLIMETERS
4. DIMENSIONS OF EXPOSED PAD ON BOTTOM OF PACKAGE DO NOT INCLUDE MOLD FLASH. MOLD FLASH, IF PRESENT, SHALL NOT EXCEED 0.15mm ON ANY SIDE
5. EXPOSED PAD SHALL BE SOLDER PLATED
6. SHADED AREA IS ONLY A REFERENCE FOR PIN 1 LOCATION ON THE TOP AND BOTTOM OF PACKAGE

LTC4078/LTC4078X

TYPICAL APPLICATION

Full Featured Li-Ion Charger

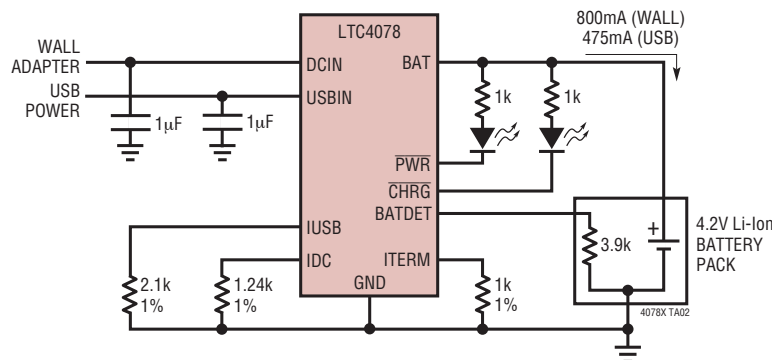

RELATED PARTS

PART NUMBER	DESCRIPTION	COMMENTS
LTC3455	Dual DC/DC Converter with USB Power Management and Li-Ion Battery Charger	Efficiency >96%, Accurate USB Current Limiting (500mA/100mA), 4mm × 4mm QFN-24 Package
LTC4053	USB Compatible Monolithic Li-Ion Battery Charger	Standalone Charger with Programmable Timer, Up to 1.25A Charge Current
LTC4054/LTC4054X	Standalone Linear Li-Ion Battery Charger with Integrated Pass Transistor in ThinSOT™	Thermal Regulation Prevents Overheating, C/10 Termination, C/10 Indicator, Up to 800mA Charge Current
LTC4055	USB Power Controller and Battery Charger	Charges Single-Cell Li-Ion Batteries Directly from USB Port, Thermal Regulation, 4mm × 4mm QFN-16 Package
LTC4058/LTC4058X	Standalone 950mA Lithium-Ion Charger in DFN	C/10 Charge Termination, Battery Kelvin Sensing, ±7% Charge Accuracy
LTC4061	Standalone Li-Ion Charger with Thermistor Interface	4.2V, ±0.35% Float Voltage, Up to 1A Charge Current
LTC4066	USB Power Controller and Li-Ion Linear Battery Charger with Low-Loss Ideal Diode	Seamless Transition Between Input Power Sources: Li-Ion Battery, USB and Wall Adapter, Low Loss (50mΩ) Ideal Diode, 4mm × 4mm QFN-24 Package
LTC4068/LTC4068X	Standalone Linear Li-Ion Battery Charger with Programmable Termination	Charge Current Up to 950mA, Thermal Regulation, 3mm × 3mm DFN-8 Package
LTC4075/ LTC4075HVX	Dual Input Standalone Li-Ion Battery Charger	950mA Charger Current, Thermal Regulation, C/X Charge Termination, USB Charge Current Set Via Resistor, 3mm × 3mm DFN Package; LTC4075HVX Has 22V Input Protection.
LTC4076	Dual Input Standalone Li-Ion Battery Charger	950mA Charger Current, Thermal Regulation, C/X Charge Termination, Fixed C or C/5 USB Charge Current for Low Power USB Operation, 3mm × 3mm DFN Package
LTC4077	Dual Input Standalone Li-Ion Battery Charger	950mA Charger Current, Thermal Regulation, C/X Charge Termination, Programmable C or C/x USB Charge Current for Low Power USB Operation, Fixed C/10 Wall Adapter and C/10 or C/2 Charge Current Termination, 3mm × 3mm DFN Package
LTC4085	USB Power Manager with Ideal Diode Controller and Li-Ion Charger	Charges Single-Cell Li-Ion Batteries Directly from USB Port, Thermal Regulation, 200mΩ Ideal Diode with <50mΩ Option, 4mm × 3mm DFN-14 Package
LTC4089/ LTC4089-5	USB Power Manager with Ideal Diode Controller and High Efficiency Li-Ion Battery Charger	High Efficiency 1.2A Charger from 6V to 36V (40V Max) Input Charges Single-Cell Li-Ion Batteries Directly from USB Port, Thermal Regulation, 200mΩ Ideal Diode with <50mΩ Option, Bat-Track Adaptive Output Control (LTC4089), Fixed 5V Output (LTC4089-5), 4mm × 3mm DFN-14 Package
LTC4411/LTC4412	Low Loss PowerPath™ Controller in ThinSOT	Automatic Switching Between DC Sources, Load Sharing, Replaces ORing Diodes

ThinSOT and PowerPath are trademarks of Linear Technology Corporation.

4078xfb

Looking for pricing, stock, or lifecycle information?

Click below to explore more details on WIN SOURCE:

 [View LTC4078EDD-2#TRPBF on WIN SOURCE](#)

 [Linear Technology](#) Information

Optimize Your Supply Chain with WIN SOURCE Solutions

-  Global Sourcing Solution
-  Obsolete Management
-  Cost Control Management
-  Shortage Management
-  Alternative Solution
-  Excess Inventory Management