



**THE DATASHEET OF
LTC4056ETS8-4.2#TRMPBF**



Linear Li-Ion Charger with Termination in ThinSOT

FEATURES

- Standalone Li-Ion Charger with Termination
- Programmable Termination Timer
- No Sense Resistor or Blocking Diode Required
- Suitable for USB-Powered Charging
- Undervoltage Charge Current Limiting
- Preset Charge Voltage with $\pm 0.6\%$ Accuracy
- Programmable Charge Current: 200mA to 700mA
- Automatic Recharge with Shortened Charge Cycle
- Self-Protection for Overcurrent/Overtemperature
- 40 μ A Supply Current in Shutdown Mode
- Negligible Battery Drain Current in Shutdown
- Low Battery Charge Conditioning (Trickle Charging)
- CHRG Status Output including AC Present
- PCB Total Solution Area only 75mm² (700mA)
- Low Profile (1mm) SOT-23 Package

APPLICATIONS

- Cellular Telephones
- Handheld Computers
- Digital Cameras
- Charging Docks and Cradles
- Low Cost and Small Size Chargers

DESCRIPTION

The LTC[®]4056 is a low cost, single-cell, constant-current/constant-voltage Li-Ion battery charger controller with a programmable termination timer. When combined with a few external components, the LTC4056 forms a very small standalone charger for single cell lithium-ion batteries.

Charge current and charge time are set externally with a single resistor and capacitor, respectively. The LTC4056 charges to a final float voltage accurate to $\pm 0.6\%$. Manual shutdown is accomplished by grounding the TIMER/SHDN pin, while removing input power automatically puts the LTC4056 into a sleep mode. Both the shutdown and sleep modes drain near zero current from the battery; the shutdown mode reduces supply current to 40 μ A.

The output driver is both current limited and thermally protected to prevent operating outside of safe limits. No external blocking diode or sense resistor is required. The LTC4056 also includes low battery charge conditioning (trickle charging), undervoltage charge current limiting, automatic recharge and a charge status output.

The LTC4056 is available in a low profile (1mm) 8-lead SOT-23 (ThinSOT[™]) package.

LT, LTC and LT are registered trademarks of Linear Technology Corporation.
ThinSOT is a trademark of Linear Technology Corporation.

TYPICAL APPLICATION

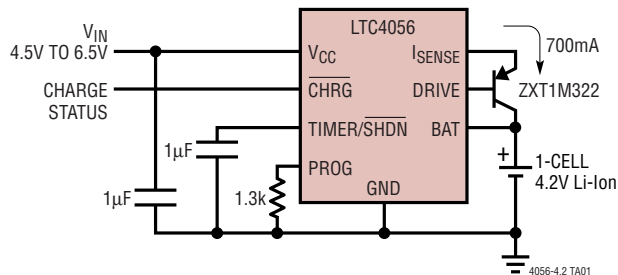

**V_{IN} Undervoltage Charge
Current Limiting**

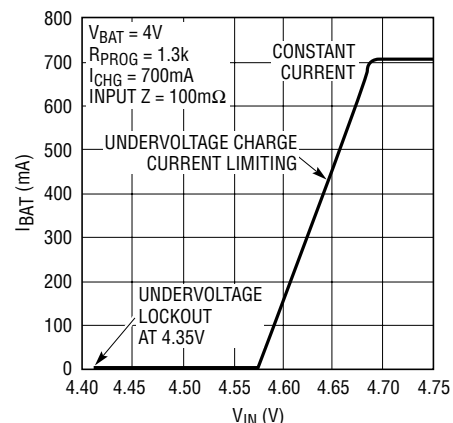

4056 TA02

405642f

ABSOLUTE MAXIMUM RATINGS

(Note 1)

Input Supply Voltage (V_{CC})	-0.3V to 10V
BAT, CHRG	-0.3V to 10V
DRIVE, PROG, TIMER/SHDN	-0.3V to ($V_{CC} + 0.3V$)
Output Current (I_{SENSE})	900mA
Short-Circuit Duration (BAT, I_{SENSE})	Continuous
Junction Temperature	125°C
Operating Ambient Temperature Range	
(Note 2)	-40°C to 85°C
Storage Temperature Range	-65°C to 150°C
Lead Temperature (Soldering, 10 sec)	300°C

PACKAGE/ORDER INFORMATION

	ORDER PART NUMBER
	LTC4056ETS8-4.2
	TS8 PART MARKING
	LTG5

Consult LTC Marketing for parts specified with wider operating temperature ranges.

ELECTRICAL CHARACTERISTICS

The ● denotes the specifications which apply over the full operating temperature range, otherwise specifications are at $T_A = 25^\circ\text{C}$. $V_{CC} = 5V$.

SYMBOL	PARAMETER	CONDITIONS	MIN	TYP	MAX	UNITS	
V_{CC} Supply							
V_{CC}	Input Supply Voltage (Note 3)		●	4.5	6.5	V	
I_{CC}	Quiescent V_{CC} Supply Current	$V_{BAT} = 4.5V$ (Forces $I_{DRIVE} = 0$) $I_{PROG} = 200\mu A$ ($R_{PROG} = 5k$)	●	400	600	μA	
I_{SHDN}	V_{CC} Supply Current in Manual Shutdown	$V_{TIMER/SHDN} = 0V$		40	60	μA	
I_{BMS}	Battery Drain Current in Manual Shutdown (Note 4)	$V_{TIMER/SHDN} = 0V$	●	-1	0	1 μA	
I_{BSL}	Battery Drain Current in Sleep Mode (Note 5)	$V_{CC} = 0V$	●	-1	0	1 μA	
V_{UVLOI}	Undervoltage Rising Threshold	V_{CC} Increasing	●	4.325	4.40	4.475	V
V_{UVLOD}	Undervoltage Falling Threshold	V_{CC} Decreasing	●	4.275	4.35	4.425	V
V_{UVHYS}	Undervoltage Hysteresis	$V_{UVLOI} - V_{UVLOD}$		50		mV	
V_{UVCL}	Undervoltage Charge Current Limit Threshold			4.575		V	
$V_{UVCL} - V_{UVLOI}$	UV Charge Current to UVLO Threshold Margin		●	90	170	250	mV
Charging Performance							
V_{FLOAT}	Output Float Voltage in Constant Voltage Mode	$I_{BAT} = 10mA$ $I_{BAT} = 10mA, 4.75V \leq V_{CC} \leq 6.5V$	●	4.175	4.200	4.225	V
				4.158	4.200	4.242	V
I_{BAT}	Output Full-Scale Current in Constant Current Mode	$R_{PROG} = 5k, 4.75V \leq V_{CC} \leq 6.5V,$ PNP Beta > 50, $0^\circ\text{C} \leq T_A \leq 85^\circ\text{C}$		137	183	228	mA
		$R_{PROG} = 1.43k, 4.75V \leq V_{CC} \leq 6.5V,$ PNP Beta > 50, $0^\circ\text{C} \leq T_A \leq 85^\circ\text{C}$		590	640	690	mA
I_{DSINK}	Drive Output Current	$V_{DRIVE} = 3V$	●	30		mA	
I_{TRIKL}	Trickle Charge Current	$V_{BAT} = 2V, R_{PROG} = 5k$ $V_{BAT} = 2V, R_{PROG} = 1.43k$		5	7	10	mA
				12	20	28	mA
V_{TRIKL}	Trickle Charge Threshold Voltage	V_{BAT} Falling	●	2.73	2.80	2.87	V
ΔV_{TRIKL}	Trickle Charge Hysteresis Voltage			45	70	95	mV
V_{PROG1}	PROG Pin Voltage	$R_{PROG} = 5k$ ($I_{PROG} = 200\mu A$)	●	0.98	1	1.02	V
V_{PROG2}	PROG Pin Voltage	$R_{PROG} = 1.43k$ ($I_{PROG} = 700\mu A$)	●	0.98	1	1.02	V

405642f

ELECTRICAL CHARACTERISTICS

The ● denotes the specifications which apply over the full operating temperature range, otherwise specifications are at $T_A = 25^\circ\text{C}$. $V_{CC} = 5\text{V}$.

SYMBOL	PARAMETER	CONDITIONS	MIN	TYP	MAX	UNITS
ΔV_{RECHRG}	Recharge Threshold Voltage	$V_{\text{FLOAT}} - V_{\text{RECHRG}}$, $V_{\text{BAT}} > V_{\text{TRIKL}}$, Charge Termination Timer Expired	100	150	200	mV
T_{TIMER}	TIMER/SHDN Accuracy	$C_{\text{TIMER}} = 1\mu\text{F}$ $R_{\text{PROG}} = 1.43\text{k}$	●	10	12	%

Charger Manual Control

V_{MSDT}	Manual Shutdown Threshold Voltage	$V_{\text{TIMER/SHDN}}$ Increasing	●	0.6	0.82	1	V
V_{MSHYS}	Manual Shutdown Hysteresis Voltage	$V_{\text{TIMER/SHDN}}$ Decreasing		50	75	125	mV
I_{SHDN}	TIMER/SHDN Pin Pull-up Current	$V_{\text{TIMER/SHDN}} = 0\text{V}$		-10	-7	-4	μA

Protection

I_{DSHRT}	Drive Output Short-Circuit Current Limit	$V_{\text{DRIVE}} = V_{\text{CC}}$	●	30	65	130	mA
I_{PSHRT}	PROG Pin Short-Circuit Current Limit	$V_{\text{PROG}} = 0\text{V}$			1.4		mA

Status Output

I_{CHRG}	CHRG Pin Weak Pull-Down Current	$V_{\text{CHRG}} = 1\text{V}$, $V_{\text{TIMER/SHDN}} = 0\text{V}$		6	12	18	μA
V_{CHRG}	CHRG Output Low Voltage	$I_{\text{CHRG}} = 10\text{mA}$	●		0.2	0.4	V

Note 1: Absolute Maximum Ratings are those values beyond which the life of a device may be impaired.

Note 2: The LTC4056E is guaranteed to meet performance specifications from 0°C to 70°C ambient temperature range. Specifications over the -40°C to 85°C operating ambient temperature range are assured by design, characterization and correlation with statistical process controls.

Note 3: Although the LTC4056 will operate with input voltages as low as 4.5V, charging will not begin until V_{CC} exceeds V_{UVCL} .

Note 4: Assumes that the external PNP pass transistor has negligible B-C reverse-leakage current when the collector is biased at 4.2V (V_{BAT}) and the base is biased at 5V (V_{CC}).

Note 5: Assumes that the external PNP pass transistor has negligible B-E reverse-leakage current when the emitter is biased at 0V (V_{CC}) and the base is biased at 4.2V (V_{BAT}).

TYPICAL PERFORMANCE CHARACTERISTICS

Float Voltage vs Temperature and Supply Voltage

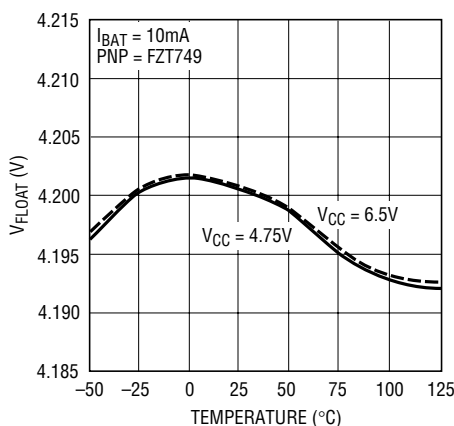

Float Voltage vs I_{BAT}

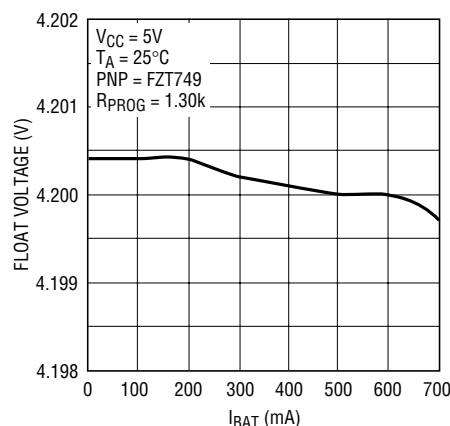

I_{BAT} vs Temperature and Supply Voltage

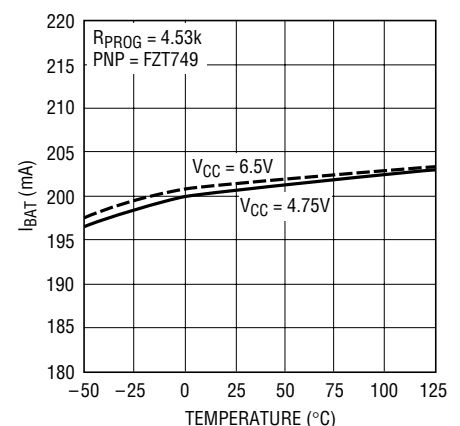

TYPICAL PERFORMANCE CHARACTERISTICS

I_{BAT} vs Temperature and Supply Voltage

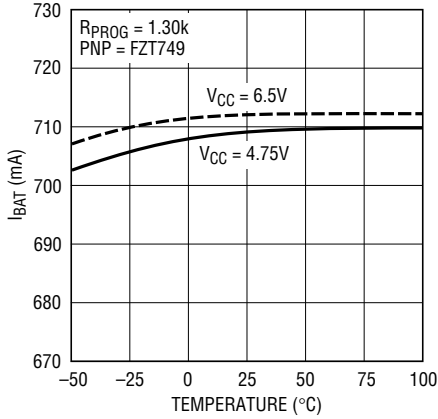

4056-4.2 G04

I_{BAT} vs V_{BAT}

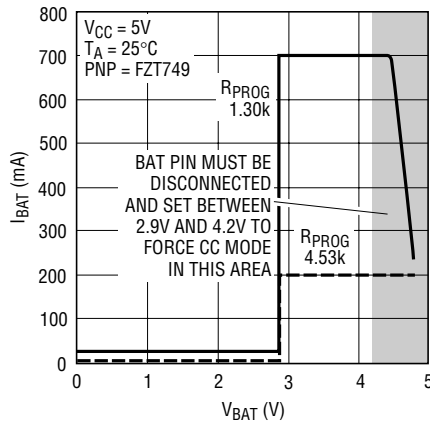

4056-4.2 G05

Timer Error vs Temperature

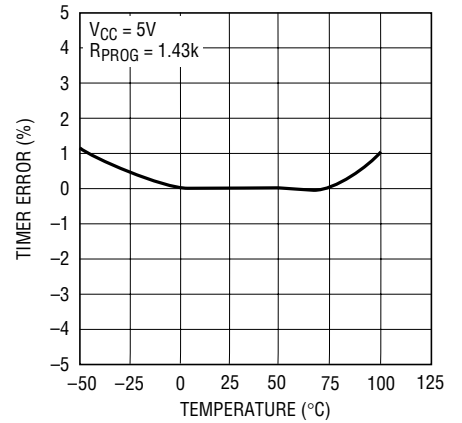

4056-4.2 G06

TIMER/SHDN Pin Pull-Up Current vs Temperature and Supply Voltage

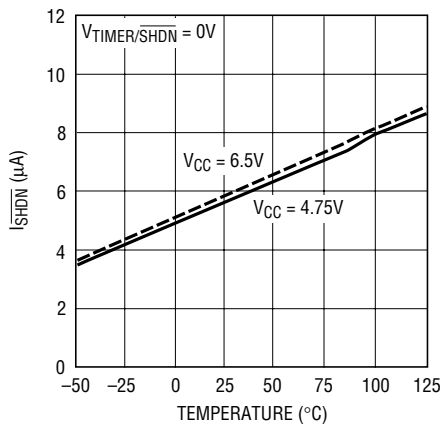

4056-4.2 G07

CHRG Pin Weak Pull-Down Current vs Temperature and V_{CHRG}

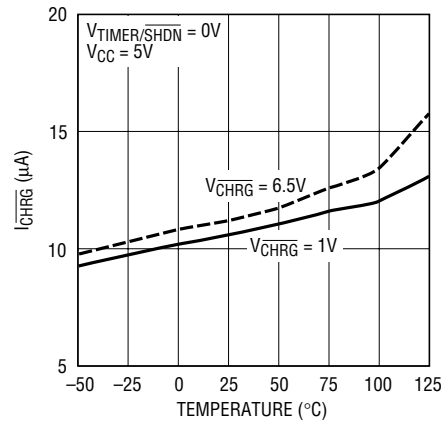

4056-4.2 G08

CHRG Pin Output Low Voltage vs Temperature

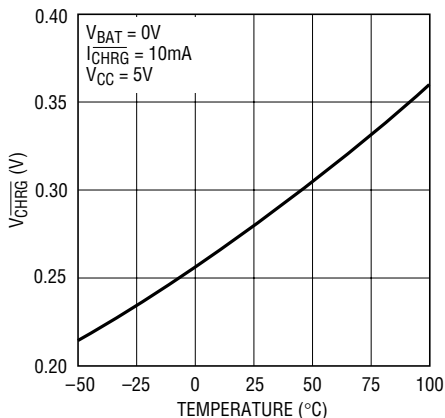

4056-4.2 G09

PROG Pin Voltage vs Temperature and R_{PROG}

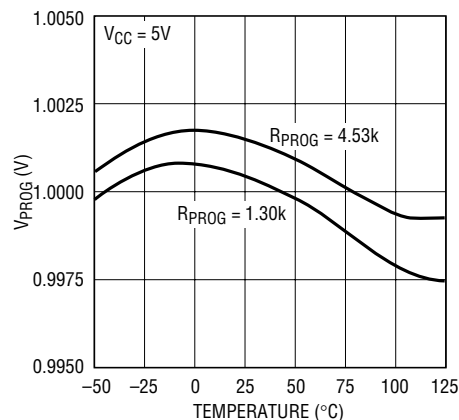

4056-4.2 G10

PIN FUNCTIONS

V_{CC} (Pin 1): Positive Input Supply Voltage. This pin supplies power to the internal control circuitry and external PNP transistor through the internal current sense resistor. This pin should be bypassed to ground with a capacitor in the range of 1 μ F to 10 μ F.

I_{SENSE} (Pin 2): Sense Node for Charge Current. Current from V_{CC} passes through the internal current sense resistor and out of the I_{SENSE} pin to supply current to the emitter of the external PNP transistor. The collector of the PNP provides charge current to the battery.

DRIVE (Pin 3): Base Drive Output for the External PNP Pass Transistor. Provides a controlled sink current to drive the base of the PNP. This pin has current limiting protection.

GND (Pin 4): Ground. Provides a reference for the internal voltage regulator and a return for all internal circuits. When in the constant voltage mode, the LTC4056 will precisely regulate the voltage between the BAT and GND pins. The battery ground should connect close to the GND pin to avoid voltage drop errors.

PROG (Pin 5): Charge Current Programming Pin. Provides a virtual reference voltage of 1V for an external resistor (R_{PROG}) connected between this pin and ground to program the battery charge current. In constant current mode the typical charge current is 915 times the current through this resistor (I_{CHG} = 915V/R_{PROG}). Current is limited to approximately 1.4mA (I_{CHG} of approximately 1.4A).

BAT (Pin 6): Battery Voltage Sense Input. A precision internal resistor divider sets the final float voltage on this pin. This divider is disconnected in the manual shutdown or sleep mode. No bypass capacitance is needed on this pin for stable operation when a battery is present. However, any low ESR capacitor exceeding 22 μ F on this pin should be decoupled with 0.2 Ω to 1 Ω resistor. Without a battery, a minimum bypass capacitance of 4.7 μ F with 0.5 Ω series resistance is required.

TIMER/SHDN (Pin 7): Programmable Charge Termination Timer and Shutdown Input. Pulling this pin below the shutdown threshold voltage will shut down the charger reducing the supply current to approximately 40 μ A and the battery drain current to near 0 μ A. A capacitor on this pin programs the charge termination timer.

CHRG (Pin 8): Open-Drain Charge Status Output. When the battery is being charged, the CHRG pin is pulled low by an internal N-channel MOSFET. When the timer has timed out (terminating the charge cycle) or when the LTC4056 is in shutdown, but power is applied to the IC (i.e., V_{CC} > V_{UVLO1}), a 12 μ A current source is connected from the CHRG pin to ground. The CHRG pin is forced to a high impedance state when input power is not present (i.e., V_{CC} < V_{UVLOD}).

BLOCK DIAGRAM

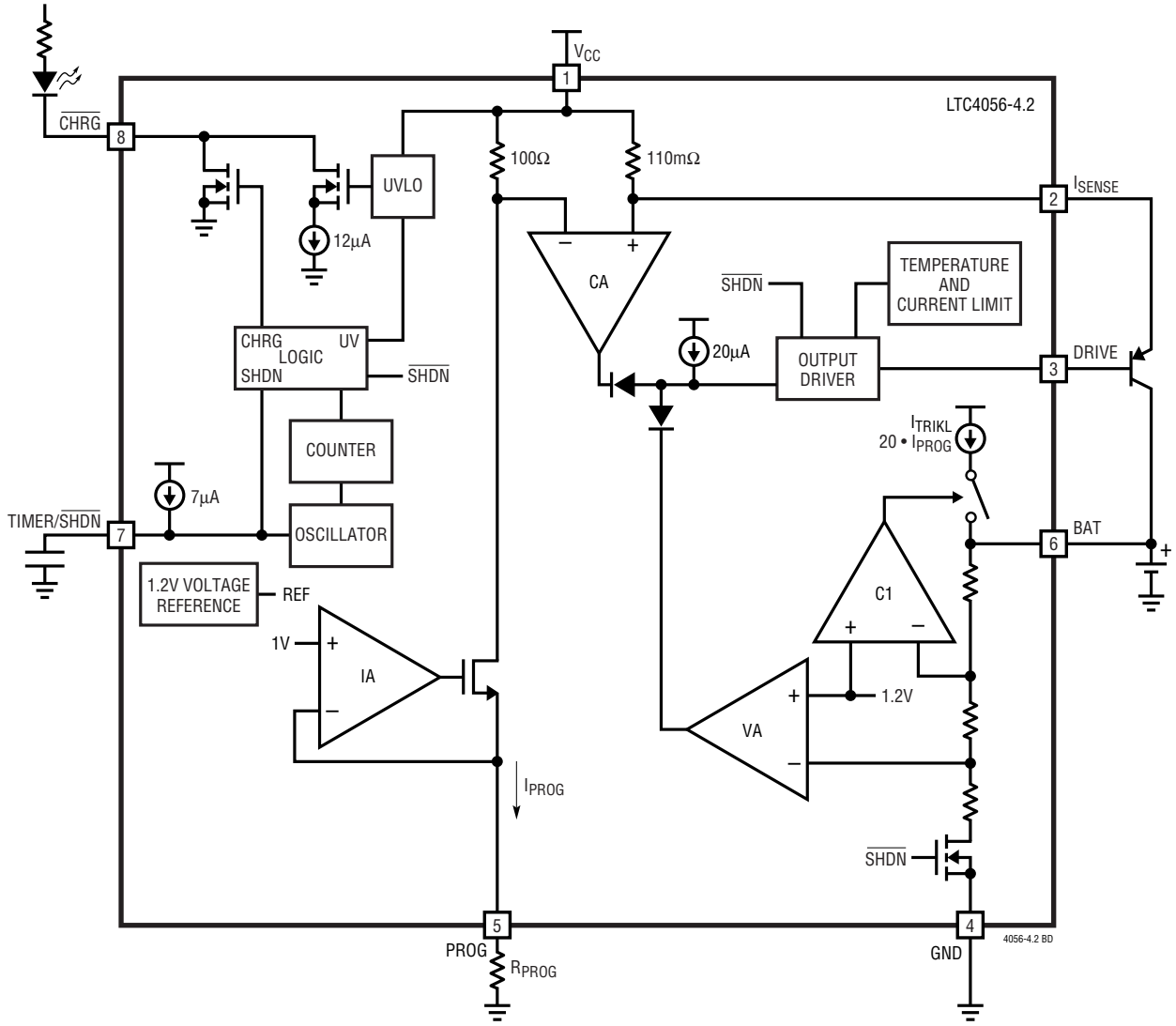

OPERATION

The LTC4056 is a linear battery charger controller with a programmable charge termination timer. Operation can be understood by referring to the Block Diagram. A charge cycle begins when V_{CC} rises above the UVLO (undervoltage lockout) threshold V_{UVLO1} (nominally 4.4V), an external current programming resistor is connected between the PROG pin and ground and the TIMER/SHDN pin is allowed to rise above the shutdown threshold V_{MSDT} (nominally 0.82V).

If the battery voltage is below V_{TRIKL} (2.8V) at the beginning of the charge cycle, the charger goes into trickle charge mode to bring the cell voltage up to a safe level for charging at full current. In this mode, an internal current source provides approximately 2% of the programmed charge current to the BAT pin. The charger goes into the full charge constant current mode once the voltage on the BAT pin rises above $V_{TRIKL} + \Delta V_{TRIKL}$ (2.9V).

During full current charging, the collector of the external PNP provides the charge current. The PNP emitter current flows through the I_{SENSE} pin and through the internal 110m Ω current sense resistor. This current is close in magnitude, but slightly more than the collector current since it includes base current. Amplifier A1 forces 1V on the PROG pin. Therefore, a current equal to $1V/R_{PROG}$ will flow through the internal 100 Ω resistor. Amplifier CA will force the same voltage that appears across the 100 Ω resistor to appear across the internal 110m Ω resistor. This amplifier ensures that the current flowing out of the I_{SENSE} pin is equal to 915 times the current flowing out of the PROG pin. Therefore, neglecting base current, the charge current will be $915V/R_{PROG}$. This region of operation is referred to as constant current mode.

As the battery accepts charge, its voltage rises. When it reaches the preset float voltage of 4.2V, a precisely divided down version of this voltage (1.2V) is compared to the 1.2V internal reference voltage by amplifier VA. If the battery voltage attempts to exceed 4.2V (1.2V at the input of amplifier VA), the amplifier will divert current away from the output driver thus limiting charge current to maintain 4.2V on the battery. This is the constant voltage mode.

An external capacitor on the TIMER/SHDN pin and the resistance between the PROG pin and ground set the total charge time. When this time elapses, the charge cycle terminates and the CHRG pin transitions from a strong pull-down to a weak 12 μ A pull-down. To restart the charge cycle, simply remove the input voltage and reapply it or momentarily force the TIMER/SHDN pin to ground. The charge cycle will also restart if the BAT pin voltage falls below the recharge threshold (V_{RECHRG} is nominally 4.05V).

When V_{CC} is applied, pulling the TIMER/SHDN pin to ground will manually shut down the charger and reset the timer. When this pin is released an internal 7 μ A current source pulls the TIMER/SHDN pin above the 0.82V shutdown threshold to resume charging.

Fault conditions such as overheating of the die or excessive DRIVE pin or PROG pin current are monitored and limited.

When input power is removed or manual shutdown is entered, the charger will drain only tiny leakage currents (<1 μ A) from the battery, thus maximizing battery standby time. With V_{CC} removed the external PNP base is connected to the battery by the charger. In manual shutdown the base is connected to V_{CC} by the charger.

APPLICATIONS INFORMATION

Undervoltage Lockout

An internal undervoltage lockout (UVLO) circuit monitors the input voltage and keeps the charger in shutdown mode until V_{CC} rises above the UVLO threshold (V_{UVLO1} is typically 4.4V). Approximately 50mV of hysteresis is built in to prevent oscillation around the threshold level. In undervoltage lockout, battery drain current is very low ($<1\mu\text{A}$) and supply current is approximately 40 μA .

Undervoltage Charge Current Limiting

The LTC4056 includes undervoltage charge current limiting that prevents full charge current until the input supply voltage reaches a threshold value (V_{UVCL}). This feature is particularly useful if the LTC4056 is powered from a supply with long leads (or any relatively high output impedance).

For example, USB powered systems tend to have highly variable source impedances (due primarily to cable quality and length). A transient load combined with such an impedance can easily trip the UVLO threshold and turn the charger off unless undervoltage charge current limiting is implemented.

Consider a situation where the LTC4056 is operating under normal conditions and the input supply voltage begins to sag (e.g. an external load drags the input supply down). If the input voltage reaches V_{UVCL} (approximately 170mV above the rising undervoltage lockout threshold, V_{UVLO1}), undervoltage charge current limiting will begin to reduce the charge current in an attempt to maintain V_{UVCL} at the V_{CC} input of the IC. The LTC4056 will continue to operate at the reduced charge current until the input supply voltage is increased or voltage mode reduces the charge current further.

Trickle Charge and Defective Battery Detection

At the beginning of a charge cycle, if the battery voltage is low (below V_{TRIKL} of about 2.8V) the charger goes into trickle charge mode reducing the charge current to approximately 2% of the full-scale current. If the low battery voltage persists for one quarter of the total charge time, the battery is assumed to be defective, the charge cycle is terminated and the $\overline{\text{CHRG}}$ pin output transitions from a strong pull-down to a 12 μA pull-down. To restart the

charge cycle, remove the input voltage and reapply it or momentarily force the $\overline{\text{TIMER/SHDN}}$ pin to ground.

Programming Charge Current

When in constant current mode, the full-scale charge current is programmed using a single external resistor between the PROG pin and ground, R_{PROG} . The current delivered to the I_{SENSE} pin (flowing from V_{CC} through the internal 110m Ω sense resistor) will be 915 times the current in R_{PROG} . Because the LTC4056 provides a virtual 1V source at the PROG pin, the charge current is given by:

$$I_{\text{CHG}} = (I_{\text{PROG}}) \cdot 915 = \left(\frac{1\text{V}}{R_{\text{PROG}}} \right) \cdot 915 \text{ or}$$

$$R_{\text{PROG}} = \left(\frac{1\text{V}}{I_{\text{CHG}}} \right) \cdot 915$$

Under trickle charge conditions, this current is reduced to approximately 2% of the full-scale value. The actual battery charge current (I_{BAT}) is slightly lower than the expected charge current because the charger forces the emitter current and the battery charge current will be reduced by the base current. In terms of β (I_C/I_B), I_{BAT} can be calculated as follows:

$$I_{\text{BAT}} (\text{A}) = 915 \cdot I_{\text{PROG}} \left(\frac{\beta}{\beta + 1} \right) = \frac{915\text{V}}{R_{\text{PROG}}} \cdot \left(\frac{\beta}{\beta + 1} \right)$$

If $\beta = 50$, then I_{BAT} is 2% low. If desired, reducing R_{PROG} by 2% can compensate for the 2% drop.

For example, if 700mA charge current is required, calculate:

$$R_{\text{PROG}} = \left(\frac{1\text{V}}{700\text{mA}} \right) \cdot 915 = 1.3\text{k}$$

If a low β needs to be compensated for, say $\beta = 50$, calculate:

$$R_{\text{PROG}} = \frac{915\text{V}}{700\text{mA}} \cdot \left(\frac{50}{50 + 1} \right) = 1.27\text{k}$$

For best stability over temperature and time, 1% metal-film resistors are recommended.

APPLICATIONS INFORMATION

Termination Timer

The programmable timer is used to terminate the charge cycle. The timer duration is programmed by an external capacitor at the $\overline{\text{TIMER/SHDN}}$ pin and the external PROG resistor. The total charge time is:

$$\text{Time(Hours)} = 1.935 \cdot R_{\text{PROG}}(\text{k}) \cdot C_{\text{TIMER}}(\mu\text{F}) \text{ or}$$

$$C_{\text{TIMER}}(\mu\text{F}) = \text{Time(Hours)} / 1.935 \cdot R_{\text{PROG}}(\text{k})$$

For example, to program a three hour timer with a 600mA charge current (i.e., $R_{\text{PROG}} = 1.54\text{k}$), calculate:

$$C_{\text{TIMER}} = \frac{3}{1.935 \cdot 1.54} = 1\mu\text{F}$$

The timer starts when an input voltage greater than the undervoltage lockout threshold level is applied, a program resistor is connected to ground and the $\overline{\text{TIMER/SHDN}}$ pin is allowed to rise above the shutdown threshold. After a time-out occurs, the charge current stops and the $\overline{\text{CHRG}}$ output transitions from a strong pull-down to a $12\mu\text{A}$ pull-down to indicate charging has stopped. As long as the input supply remains above V_{UVLOD} and the battery voltage remains above V_{RECHRG} the charger will remain in this standby mode.

If the battery voltage remains below V_{TRIKL} for 25% of the programmed time, the charger will enter standby mode. Furthermore, if the battery voltage is above the recharge threshold (V_{RECHRG} is typically 4.05V) at the beginning of a charge cycle or if a falling battery voltage triggers a recharge cycle (following a previous time-out), the charge cycle will be shortened to 50% of the programmed time. This feature reduces the charge time for batteries that are near full capacity. Connecting the $\overline{\text{TIMER/SHDN}}$ pin to V_{CC} disables the timer function.

Manual Shutdown

Pulling the $\overline{\text{TIMER/SHDN}}$ pin below $V_{\text{MSDT}} - V_{\text{MSHYS}}$ (typically 0.745V) will put the charger into shutdown mode and reset the timer. In this mode, the LTC4056 consumes $40\mu\text{A}$ of supply current and drains a negligible leakage current from the battery (I_{BMS}).

A $7\mu\text{A}$ current source pulls up on the $\overline{\text{TIMER/SHDN}}$ pin while in shutdown to ensure that the IC will start up once

the $\overline{\text{TIMER/SHDN}}$ pin is released. Given the low magnitude of this current, it is a simple matter for an external open-drain (or open-collector) output to pull the $\overline{\text{TIMER/SHDN}}$ pin to ground for shutdown and release the pin for normal operation.

Sleep Mode

When the input supply is disconnected, the IC enters the sleep mode. In this mode, the battery drain current (I_{BSL}) is a negligible leakage current, allowing the battery to remain connected to the charger for an extended period of time without discharging the battery. The leakage current is due to the reverse-biased B-E junction of the external PNP transistor. Furthermore, the $\overline{\text{CHRG}}$ pin assumes a high impedance state.

$\overline{\text{CHRG}}$ Status Output Pin

When the charge cycle starts, the $\overline{\text{CHRG}}$ pin is pulled to ground by an internal N-channel MOSFET capable of driving an LED. When the charge cycle ends, the strong pull-down transitions to a $12\mu\text{A}$ pull-down on the $\overline{\text{CHRG}}$ pin as long as the input supply remains above the UVLO threshold (V_{UVLOD}) and the battery voltage remains above V_{RECHRG} . If the input supply falls below V_{UVLOD} , the $\overline{\text{CHRG}}$ pin assumes a high impedance state. Figure 1 shows a flow diagram for a typical charge cycle. This diagram indicates the status of the $\overline{\text{CHRG}}$ pin in each charger state.

A microprocessor can be used to distinguish the three states of the $\overline{\text{CHRG}}$ pin (see Figure 2). To detect whether the LTC4056 is in trickle charge, charge, or short charge mode (i.e., strong pull-down), force the digital output pin (OUT) high and measure the voltage at the $\overline{\text{CHRG}}$ pin. The internal N-channel MOSFET will pull the pin voltage low even with the 2k pull-up resistor. Once the charge cycle terminates, the strong pull-down transitions to a $12\mu\text{A}$ pull-down. The IN pin will then be pulled high by the 2k pull-up resistor. To determine whether sufficient input voltage is present for charging (i.e., high impedance), the OUT pin should be forced to a high impedance state. If $V_{\text{CC}} > V_{\text{UVLOI}}$ then the $12\mu\text{A}$ $\overline{\text{CHRG}}$ pull-down will pull the IN pin low through the 800k resistor; otherwise, the 800k resistor will pull the IN pin high, indicating that $V_{\text{CC}} < V_{\text{UVLOD}}$.

APPLICATIONS INFORMATION

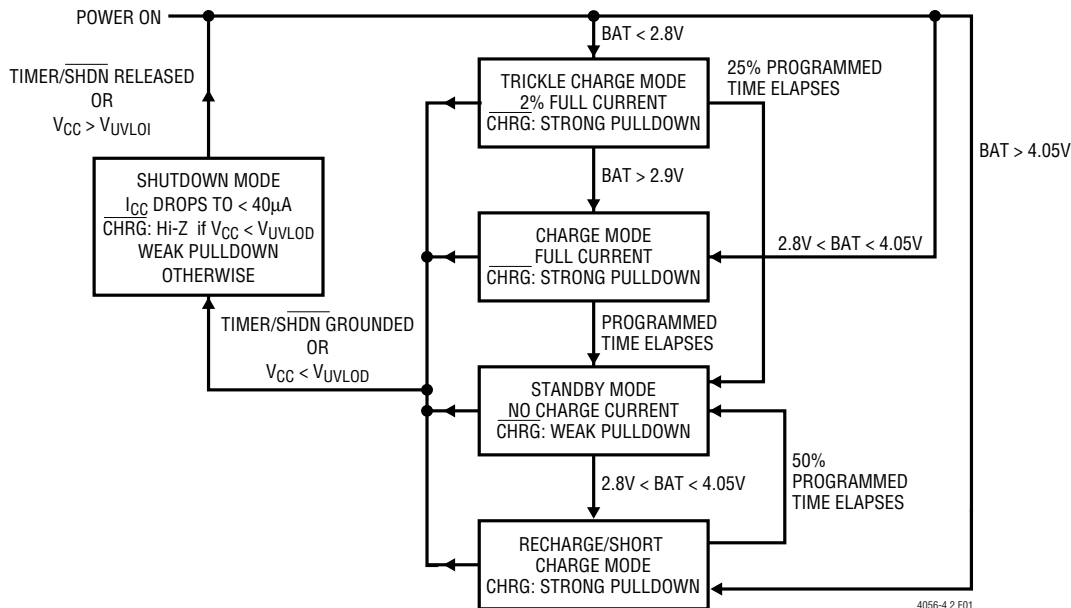
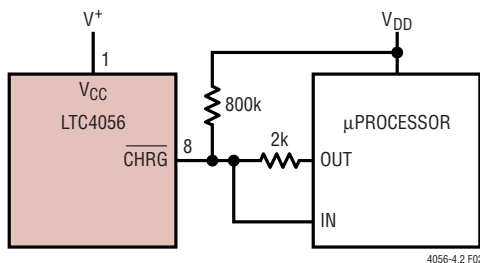

Figure 1. State Diagram for a Typical Charge Cycle

Figure 2. Using a Microprocessor to Determine $\overline{\text{CHRG}}$ State

Recharge

If the battery voltage drops below V_{RECHRG} (typically 4.05V) after a charge cycle has terminated, a new charge cycle will begin. The recharge circuit integrates the BAT pin voltage for approximately a millisecond to prevent a transient from restarting the charge cycle. During a recharge cycle the timer will terminate the charge cycle after one-half of the programmed time has elapsed.

If the battery voltage remains below V_{TRIKL} (typically 2.8V) during trickle charge for one-fourth of the programmed time, the battery may be defective and the charge cycle will end. In addition, the recharge comparator is disabled and a new charge cycle will not begin unless the input voltage is toggled off then on, or the $\overline{\text{TIMER/SHDN}}$ pin is momentarily pulled to ground.

External PNP Transistor

The external PNP pass transistor must have adequate beta, low saturation voltage and sufficient power dissipation capability (including any heat sinking, if required).

To provide 700mA of charge current with the minimum available base drive of approximately 30mA requires a PNP beta greater than 23. If lower beta PNP transistors are used, more base current is required from the LTC4056. This can result in the output drive current limit being reached, or thermal shutdown due to excessive power dissipation.

With low supply voltages, the PNP saturation voltage (V_{CESAT}) becomes important. The V_{CESAT} must be less than the minimum supply voltage minus the maximum voltage drop across the internal sense resistor and bond wires (0.20Ω) and battery float voltage. If the PNP transistor cannot achieve the low saturation voltage required, base current will dramatically increase. This is to be avoided for a number of reasons: output drive may reach current limit resulting in the charger characteristics to go out of specifications, excessive power dissipation may force the IC into thermal shutdown, or the battery could become discharged because some of the current from the

APPLICATIONS INFORMATION

DRIVE pin could be pulled from the battery through the forward biased collector base junction.

For example, to program a charge current of 500mA with a minimum supply voltage of 4.75V, the minimum operating V_{CE} is:

$$V_{CE(MIN)}(V) = 4.75 - (0.5) \cdot (0.2) - 4.2 = 0.45V$$

Another important factor to consider when choosing the PNP pass transistor is the power handling capability. The transistor data sheet will usually give the maximum rated power dissipation at a given ambient temperature with a power derating for elevated temperature operation. The maximum power dissipation of the PNP when charging is:

$$P_{D(MAX)}(W) = I_{BAT} \cdot (V_{CC(MAX)} - V_{BAT(MIN)})$$

$V_{CC(MAX)}$ is the maximum supply voltage and $V_{BAT(MIN)}$ is the minimum battery voltage when discharged.

Once the maximum power dissipation and $V_{CE(MIN)}$ are known, Table 1 can be used as a guide in selecting some PNPs to consider. In the table, very low V_{CESAT} is less than 0.25V, low V_{CESAT} is 0.25V to 0.5V and the others are 0.5V to 0.8V all depending on the current. See the manufacturer data sheet for details. All of the transistors are rated to carry at least 1A continuously as long as the power dissipation is within limits. In addition, the maximum supply voltage, minimum battery voltage and chosen

charge current should be checked against the manufacturer's data sheet to ensure that the PNP transistor is operating within its safe operating area. The Stability section addresses caution in the use of very high beta PNP transistors.

Should overheating of the PNP transistor be a concern, protection can be achieved with a positive temperature coefficient (PTC) thermistor wired in series with the current programming resistor and thermally coupled to the transistor. The PTH9C chip series from Murata has a steep resistance increase at temperature thresholds from 85°C to 145°C making it behave somewhat like a thermostat switch. For example, the model PTH9C16TBA471Q thermistor is 470Ω at 25°C but abruptly increases its resistance to 4.7k at 125°C. Below 125°C, the device exhibits a small negative TC. The 470Ω thermistor can be added in series with a 976Ω resistor to form the current programming resistor for a 640mA charger. Should the thermistor reach 125°C, the charge current will drop to 160mA and inhibit any further increase in temperature.

Stability

The LTC4056 contains two control loops: constant voltage and constant current. The constant voltage loop is stable without any compensation when a battery is connected with low impedance leads. Excessive lead length,

Table 1. PNP Pass Transistor Selection Guide

MAXIMUM $P_D(W)$ MOUNTED ON BOARD AT $T_A = 25^\circ C$	PACKAGE STYLE	ZETEX PART NUMBER	ROHM PART NUMBER	COMMENTS
3	2 x 2MLP	ZXT1M322		Very Low V_{CESAT}
0.5	SOT-23	FMMT549		Low V_{CESAT}
0.625	SOT-23	FMMT720		Very Low V_{CESAT} , High Beta
1	SOT-89	FCX589 or BCX69		
1.1	SOT-23-6	ZXT13P12DE6		Very Low V_{CESAT} , High Beta, Small
1 to 2	SOT-89	FCX717		Very Low V_{CESAT} , High Beta
2	SOT-223	FZT589		Low V_{CESAT}
2	SOT-223	BCP69 or FZT549		
0.75	FTR		2SB822	Low V_{CESAT}
1	ATV		2SB1443	Low V_{CESAT}
2	SOT-89		2SA1797	Low V_{CESAT}
10 ($T_C = 25^\circ C$)	TO-252		2SB1182	Low V_{CESAT} , High Beta

APPLICATIONS INFORMATION

however, may add enough series inductance to require a bypass capacitor of at least $1\mu\text{F}$ from BAT to ground. Furthermore, a $4.7\mu\text{F}$ capacitor with a 0.2Ω to 1Ω series resistor from BAT to ground is required to keep ripple voltage low when the battery is disconnected.

High value capacitors with very low ESRs (especially ceramic) reduce the constant voltage loop phase margin, possibly resulting in instability. Ceramic capacitors up to $22\mu\text{F}$ may be used in parallel with a battery, but larger ceramics should be decoupled with 0.2Ω to 1Ω of series resistance.

In the constant current mode, the PROG pin is in the feedback loop, not the battery. Because of the additional pole created by PROG pin capacitance, any additional capacitance on this pin must be limited. Although higher charge current applications (i.e., lower program resistance) can tolerate more PROG capacitance, a good rule of thumb is to keep the capacitive loading on the PROG pin to less than 660pF .

If additional capacitance on this pin is required (e.g., to provide an accurate, filtered low current 1V reference to external circuitry) a 1k to 10k decoupling resistor may be needed (see Figure 3).

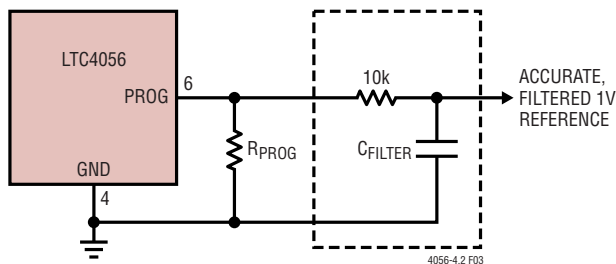

Figure 3. Isolating Capacitive Load on PROG Pin and Filtering

Reverse Polarity Input Voltage Protection

In some applications, protection from reverse polarity voltage on V_{CC} is desired. If the supply voltage is high enough, a series blocking diode can be used. In other cases, where the voltage drop must be kept low, a P-channel MOSFET can be used (as shown in Figure 4).

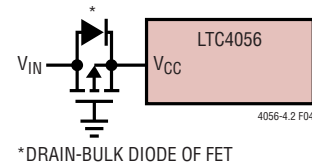

Figure 4. Low Loss Input Reverse Polarity Protection

V_{CC} Bypass Capacitor

Many types of capacitors with values ranging from $1\mu\text{F}$ to $10\mu\text{F}$ located close to the LTC4056 will provide adequate input bypassing. However, caution must be exercised when using multilayer ceramic capacitors. Because of the self-resonant and high Q characteristics of some types of ceramic capacitors, high voltage transients can be generated under some start-up conditions, such as connecting the charger input to a hot power source. For more information refer to Application Note 88.

Internal Protection

Internal protection is provided to prevent excessive PROG pin currents (I_{PSHRT}), excessive DRIVE pin currents (I_{DSHRT}) and excessive self-heating of the LTC4056 during a fault condition. The faults can be generated from a shorted PROG pin, a shorted DRIVE pin or from excessive DRIVE pin current to the base of the external PNP transistor when it is in deep saturation from a very low V_{CE} . This protection is not designed to prevent overheating of the external pass transistor. However, thermal coupling between the external PNP and the LTC4056 will allow the internal thermal limit to deprive the PNP of base current when the junction temperature of the IC rises above about 135°C . The temperature of the PNP at that point, however, will be well in excess of 135°C . The exact temperature of the PNP depends on the thermal coupling between the LTC4056 and the PNP and on the θ_{JA} of the transistor. See the section titled “External PNP Transistor” for information on protecting the transistor from overheating.

TYPICAL APPLICATIONS

It is important to keep in mind that the LTC4056 can only control charge current. If the system load is less than 500mA, then the LTC4056 can simply reduce the charge current by an amount equal to the system load current and the USB specification can be met. For instance, if the system load is 150mA, then the charge current will be reduced from 490mA to 340mA and the total USB input current will remain at 490mA, thereby meeting the specification.

However, if the system load is increased beyond 500mA the LTC4056 will reduce the charge current to zero, and all of the system load will be provided by the USB input. This scenario will violate the USB power specification. In order to avoid this situation, it is important to ensure that the system load never exceeds 500mA.

The LTC4412 provides automatic switchover of the system load between a battery and the USB input supply. This feature reduces the current drain on the battery to just a few microamps when a USB input is present. Figure 5 shows a dual FET solution to minimize voltage drop between the USB input voltage and the system load and Figure 6 uses a Schottky diode to simplify the design. Please refer to the LTC4412 data sheet for more information on the operation of the Ideal Diode Controller.

In both designs all USB input current passes through the sense resistor of the LTC4056 to ensure that the maximum current drawn from the USB input supply is limited to less than 500mA (assuming the system load is less than 500mA).

In Figure 6, P-channel MOSFET, M3, provides drive for the green LED that illuminates when the USB input supply is present. In both designs, the CHRG pin of the LTC4056 drives the red LED to indicate charging. Keep in mind that the Li-Ion battery will charge at a reduced rate if a significant system load is present. This is due to the fact that the 490mA charge current is split between the battery and the system load.

Optional N-channel MOSFET, M1, can be used to shut down the LTC4056 thereby reducing its input supply current to about 40 μ A. This will automatically turn off the red LED. However, since voltage will still be present on the USB input (and therefore the I_{SENSE} pin), Figure 6 will continue to draw power through the green LED. The green

LED should not be used without additional control logic if a low current standby mode is required.

NiCd or NiMH Charging

The application circuit in Figure 7 shows how to use an LTC4056 to charge Nickel chemistry batteries with user termination. NiCd or NiMH batteries require constant current charging regardless of the battery voltage. To disable the voltage mode of the LTC4056 it is necessary to connect the BAT pin to a voltage between the trickle charge threshold and the final float voltage.

Assuming a reasonably well controlled input voltage, this can be accomplished with a simple resistor divider connected between the input supply and the BAT pin. In Figure 7, resistors R3 and R4 keep the BAT pin voltage between the required voltage levels provided the input voltage is between 4.5V and 6.1V (encompassing nearly the entire specified operating input supply range of 4.5V to 6.5V). The LTC4056 has an internal impedance of approximately 2M Ω to GND on the BAT pin, so it is important to keep the impedance of the resistor divider considerably below that value. Furthermore, a 0.1 μ F bypass capacitor may be required between the BAT pin and GND. If the input voltage rises above 6.1V then it is possible that the battery charge current will decrease due to the voltage mode amplifier of the LTC4056.

The TIMER/SHDN manual shutdown threshold of the LTC4056 is typically 0.82V, allowing the I/O port of a microcontroller to drive this pin with standard logic levels to manually control termination. Holding the TIMER/SHDN pin high simultaneously enables the charger and disables the internal timer function. A programmed constant current will be provided to the battery until the I/O port pulls the TIMER/SHDN pin to GND.

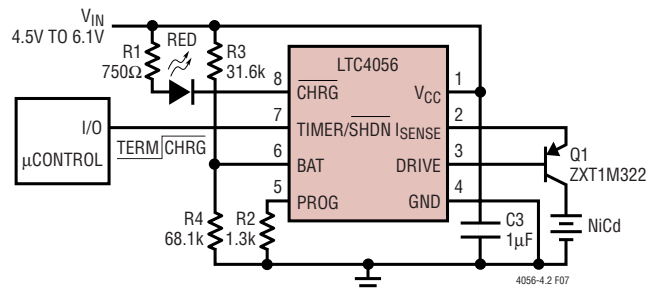
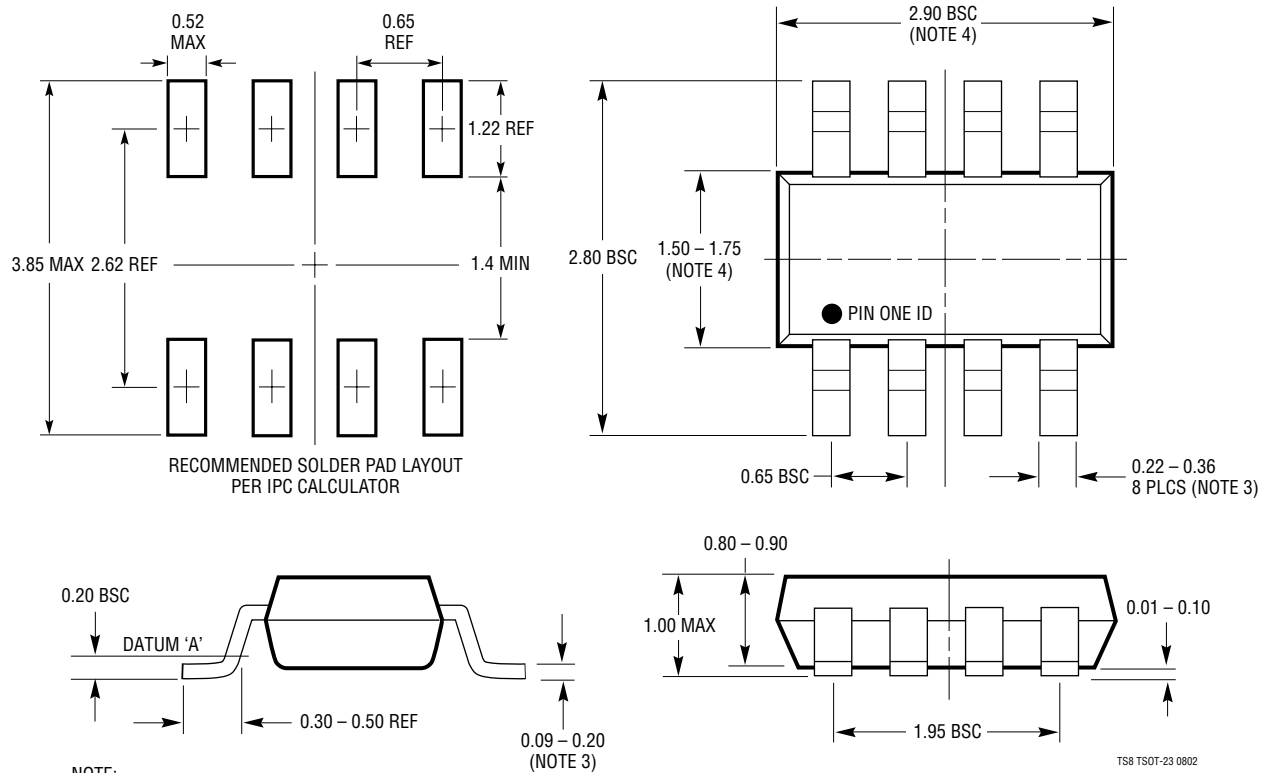

Figure 7. Nickel Chemistry Battery Charging

405642f

PACKAGE DESCRIPTION

TS8 Package
8-Lead Plastic TSOT-23
 (Reference LTC DWG # 05-08-1637)



NOTE:

1. DIMENSIONS ARE IN MILLIMETERS
2. DRAWING NOT TO SCALE
3. DIMENSIONS ARE INCLUSIVE OF PLATING
4. DIMENSIONS ARE EXCLUSIVE OF MOLD FLASH AND METAL BURR
5. MOLD FLASH SHALL NOT EXCEED 0.254mm
6. JEDEC PACKAGE REFERENCE IS MO-193

RELATED PARTS

PART NUMBER	DESCRIPTION	COMMENTS
LTC1732	Lithium-Ion Linear Battery Charger Controller	Simple Charger uses External FET, Features Preset Voltages, C/10 Charger Detection and Programmable Timer, Input Power Good Indication
LTC1733	Monolithic Lithium-Ion Linear Battery Charger	Standalone charger with Programmable Timer, Up to 1.5A Charge Current, Thermal Regulation Prevents Overheating
LTC1734	Lithium-Ion Linear Battery Charger in ThinSOT	200mA to 700mA, Simple ThinSOT Charger, No Blocking Diode, No Sense Resistor Needed
LTC1734L	Lithium-Ion Linear Battery Charger Controller	50mA to 180mA, No Blocking Diode, No Sense Resistor Needed
LTC4002	Switch Mode Li-Ion Charger	4.7V ≤ V _{IN} ≤ 24V, Up to 3A, 3Hr Timer, SO-8, DFN
LTC4050	Lithium-Ion Linear Battery Charger Controller	Simple Charger uses External FET, Thermistor Input for Battery Temperature Sensing
LTC4052	Lithium-Ion Linear Battery Pulse Charger	Fully Integrated, Standalone Pulse Charger, Minimal Heat Dissipation, Over Current Protection
LTC4053	USB Compatible Lithium-Ion Battery Linear Monolithic Charger	Fully Integrated, Standalone Charger, 10-Lead MSOP, Thermal Regulation Prevents Overheating when Powered from Wall Adapter and ≥1A Charge Current
LTC4054	Standalone Lithium-Ion Linear Battery Charger in ThinSOT	Programmable Charge Current Up to 800mA; C/10 Charge Termination, Complete Charger; No External MOSFET, Diode or Sense Resistor
LTC4057	800mA Linear Li-Ion Charger	Thermal Regulation, Charge Current Monitor Pin, SOT-23
LTC4058	950mA Linear Li-Ion Charger	3mm × 3mm DFN Package, C/10 Charge Termination, Standalone
LTC4064	Back-Up Li-Ion Battery Charger	Preset 4V Charge Voltage, Prolongs Battery Life Time, Standalone
LTC4410	USB Power Manager	Manages Total Power Between a USB Peripheral and Battery Charger; Ensures Simultaneous Charging and use of Peripheral, ThinSOT Package

Looking for pricing, stock, or lifecycle information?

Click below to explore more details on WIN SOURCE:

 [View LTC4056ETS8-4.2#TRMPBF on WIN SOURCE](#)

 [Linear Technology](#) Information

Optimize Your Supply Chain with WIN SOURCE Solutions

-  Global Sourcing Solution
-  Obsolete Management
-  Cost Control Management
-  Shortage Management
-  Alternative Solution
-  Excess Inventory Management